

## PCM-9343

**3.5" Biscuit with DM&P  
Vortex86DX-1.0 GHz, PC/104 ,  
VGA/TTL/LVDS, LAN, On-board  
Memory, SATA, USB and CF**

*Trusted ePlatform Services*

**ADVANTECH**

---

## Copyright

The documentation and the software included with this product are copyrighted 2010 by Advantech Co., Ltd. All rights are reserved. Advantech Co., Ltd. reserves the right to make improvements in the products described in this manual at any time without notice.

No part of this manual may be reproduced, copied, translated or transmitted in any form or by any means without the prior written permission of Advantech Co., Ltd. Information provided in this manual is intended to be accurate and reliable. However, Advantech Co., Ltd. assumes no responsibility for its use, nor for any infringements of the rights of third parties, which may result from its use.

## Acknowledgements

Award is a trademark of Award Software International, Inc.

DM&P is a trademark of DM&P Technologies, Inc.

IBM, PC/AT, PS/2 and VGA are trademarks of International Business Machines Corporation.

Microsoft Windows® is a registered trademark of Microsoft Corp.

RTL is a trademark of Realtek Semi-Conductor Co., Ltd.

ESS is a trademark of ESS Technology, Inc.

UMC is a trademark of United Microelectronics Corporation.

SMI is a trademark of Silicon Motion, Inc.

CHRONTEL is a trademark of Chrontel Inc.

All other product names or trademarks are properties of their respective owners.

## Product Warranty (2 years)

Advantech warrants to you, the original purchaser, that each of its products will be free from defects in materials and workmanship for two years from the date of purchase.

This warranty does not apply to any products which have been repaired or altered by persons other than repair personnel authorized by Advantech, or which have been subject to misuse, abuse, accident or improper installation. Advantech assumes no liability under the terms of this warranty as a consequence of such events.

Because of Advantech's high quality-control standards and rigorous testing, most of our customers never need to use our repair service. If an Advantech product is defective, it will be repaired or replaced at no charge during the warranty period. For out-of-warranty repairs, you will be billed according to the cost of replacement materials, service time and freight. Please consult your dealer for more details.

If you think you have a defective product, follow these steps:

1. Collect all the information about the problem encountered. (For example, CPU speed, Advantech products used, other hardware and software used, etc.) Note anything abnormal and list any onscreen messages you get when the problem occurs.
2. Call your dealer and describe the problem. Please have your manual, product, and any helpful information readily available.
3. If your product is diagnosed as defective, obtain an RMA (return merchandise authorization) number from your dealer. This allows us to process your return more quickly.
4. Carefully pack the defective product, a fully-completed Repair and Replacement Order Card and a photocopy proof of purchase date (such as your sales receipt) in a shippable container. A product returned without proof of the purchase date is not eligible for warranty service.
5. Write the RMA number visibly on the outside of the package and ship it prepaid to your dealer.

## Technical Support and Assistance

1. Visit the Advantech web site at [www.advantech.com/support](http://www.advantech.com/support) where you can find the latest information about the product.
2. Contact your distributor, sales representative, or Advantech's customer service center for technical support if you need additional assistance. Please have the following information ready before you call:
  - Product name and serial number
  - Description of your peripheral attachments
  - Description of your software (operating system, version, application software, etc.)
  - A complete description of the problem
  - The exact wording of any error messages

## Packing List

Before installation, please ensure the following items have been shipped:

**Item Part Number**

- 1 PCM-9343 SBC
- 1 Startup manual
- 1 Utility CD
- 1 mini jumper pack
- Cables

Part Number	Description
1700008894	SATA cable 30CM
1700060202	Keyboard/Mouse cable
1700100250	COM3/COM4 cable
1700260250	Parallel port cable
1701140201	COM2 cable
1703100121	USB 2 port cable
1700017863	LAN Cable (PCM-9343FG only)

## Ordering information

Model Number	Description
PCM-9343FG-S6A1E	DMP Vortex86DX 3.5" SBC w/graphic,512MB,dual LAN
PCM-9343F-S6A1E	DMP Vortex86DX 3.5" SBC w/graphic, 256MB memory
PCM-9343L-S6A1E	DMP Vortex86DX 3.5" SBC w/o graphic,256MB memory

## Optional accessories

Part No.	Description
1703150102	SATA 10cm Power cable

# Contents

<b>Chapter 1</b>	<b>General Introduction .....</b>	<b>1</b>
1.1	Introduction .....	2
1.2	Product Feature .....	2
1.3	Specifications .....	3
1.3.1	Functional Specification .....	3
1.3.2	Mechanical Specification .....	4
1.3.3	Electrical Specification .....	5
1.4	Environmental Specification .....	5
<b>Chapter 2</b>	<b>H/W installation.....</b>	<b>7</b>
2.1	Jumpers .....	8
2.1.1	Jumper list.....	8
	Table 2.1: Jumper list .....	8
2.1.2	Jumper Settings .....	8
	Table 2.2: J1: LCD Power .....	8
	Table 2.3: J2: VBR_Ctrl.....	8
	Table 2.4: J3: COM2 Setting .....	9
	Table 2.5: J4: HDD & PWR LED Setting .....	9
2.1.3	Jumper Description .....	10
2.1.4	External SPI Flash .....	10
2.2	Connectors.....	11
2.2.1	Connector list.....	11
	Table 2.6: Connector list.....	11
2.2.2	Connector Settings .....	11
2.3	Mechanical.....	14
2.3.1	Jumper and Connector Location.....	14
	Figure 2.1 Jumper and Connector layout (Component side).....	14
	Figure 2.2 Jumper and Connector layout (Solder side).....	15
2.3.2	Board Dimension .....	15
	Figure 2.3 Board Dimension layout (Component side).....	15
	Figure 2.4 Board Dimension layout (Solder side).....	16
	Figure 2.5 Board Dimension layout (Coastline).....	16
<b>Chapter 3</b>	<b>BIOS Operation .....</b>	<b>17</b>
3.1	BIOS Introduction .....	18
3.2	BIOS Setup .....	18
3.2.1	Main Menu .....	19
3.2.2	Standard CMOS Features .....	20
3.2.3	Advanced BIOS Features .....	21
3.2.4	Advanced Chipset Features.....	22
3.2.5	Integrated Peripherals.....	23
3.2.6	PnP/PCI Configurations .....	24
3.2.7	Load Optimized Defaults.....	25
3.2.8	Set Password.....	25
3.2.9	Save & Exit Setup .....	27
3.2.10	Quit Without Saving .....	27
<b>Chapter 4</b>	<b>Extension I/O Installation.....</b>	<b>29</b>
4.1	PC/104 .....	30

## Chapter 5 S/W Introduction & Installation..... 31

5.1	S/W Introduction .....	32
5.2	Driver Installation .....	32
5.2.1	Windows XP Professional.....	32
5.2.2	Other OS.....	32
5.3	Value-Added Software Services .....	32
5.3.1	SUSI Introduction.....	32
5.3.2	Software APIs .....	33
5.3.3	SUSI Utilities.....	34
5.3.4	SUSI Installation .....	34
5.3.5	SUSI Sample Programs.....	36

## Appendix A PIN Assignments ..... 41

A.1	PIN Assignments .....	42
	Table A.1: CN1: SATA.....	42
	Table A.2: CN2: LPT.....	42
	Table A.3: CN3: 24 bits TTL Panel .....	43
	Table A.4: CN4: 24 bits LVDS Panel .....	45
	Table A.5: CN5: COM3 .....	46
	Table A.6: CN6: JTAG .....	46
	Table A.7: CN7: Inverter Power Output .....	46
	Table A.8: CN8: Internal USB .....	47
	Table A.9: CN9: Internal USB .....	47
	Table A.10:CN10: ISA -5V & -12V Input.....	48
	Table A.11:CN11: AT Power Input .....	48
	Table A.12:CN12: GPIO .....	49
	Table A.13:CN13: PC104 .....	49
	Table A.14:CN14: GPIO .....	52
	Table A.15:CN15: SMBus.....	53
	Table A.16:CN16: BIOS Socket.....	53
	Table A.17:CN17: COM4.....	54
	Table A.18:CN18: LAN2 .....	54
	Table A.19:CN19: COM2.....	55
	Table A.20:CN20: LAN1 .....	55
	Table A.21:CN21: PS2 .....	56
	Table A.22:CN22: VGA.....	56
	Table A.23:CN23: COM1.....	57
	Table A.24:CN24: CF .....	57

## Appendix B System Assignments..... 59

B.1	System I/O Ports.....	60
	Table B.1: System I/O Ports .....	60
B.2	1st MB memory map.....	60
	Table B.2: 1st MB memory map .....	60
B.3	DMA channel assignments .....	61
	Table B.3: DMA channel assignments.....	61
B.4	Interrupt assignments .....	61
	Table B.4: Interrupt assignments.....	61

## Appendix C GPIO & WDT Sample Code ..... 63

C.1	[PCM-9343 WDT].....	64
C.2	[PCM-9343 GPIO].....	65

# Chapter 1

## General Introduction

This chapter gives background information on the PCM-9343.

Sections include:

- Introduction
- Product feature
- Specifications

## 1.1 Introduction

The PCM-9343 is a 3.5" SBC (Stackable Board Computer) with DM&P Vortex86DX-1.0 GHz SoC. The PCM-9343 has onboard memory up to 256/512MB, supports four USB 2.0 compatible ports, two LAN interface(PCM-9343FG only), LVDS/TTL/VGA function , and four COM ports. In addition, the PCM-9343 also supports one SATA, one CF slot and one PC/104 expansion.

## 1.2 Product Feature

### General

- **CPU:** DM&P Vortex86DX 1.0 GHz SoC
- **System Chipset:** DM&P Vortex86DX SoC
- **BIOS:** Award 16 Mbit Flash BIOS
- **System Memory:** 256/512MB on board DDR2 SDRAM
- **SSD:** Supports CompactFlash Card TYPE I/II
- **Watchdog Timer:** Single chip Watchdog 255-level interval timer, setup by software
- **Expansion Interface:** Supports 1xPC/104 expansion
- **Battery:** Lithium 3 V/210 mA

### I/O

- **I/O Interface:** 1 x SATA, 1 x KB/mouse, 3 x RS232, 1 x RS232/422/485, 1 x LPT
- **USB:** 4 x USB 2.0 compliant Ports
- **Audio:** N/A
- **GPIO:** 16-bit general purpose input/output
- **External SPI on board Flash:** Optional onboard 4MByte SPI Flash Disk(Support by request for boot device or storage on DOS OS)
- **I2C:** Compliant w/t V2.1, Some master code (general call, START and CBUS) not support

### Ethernet

- **Chipset:** LAN1 DM&P Vortex86DX,  
LAN2 Realtek RTL8110SC(PCM-9343FG only)
- **Speed:** 10/100 Mbps
- **Interface:** 1 x RJ45,  
1 x internal connector (PCM-9343FG only)
- **Standard:** Compliant with IEEE 802.3, IEEE 802.3u

### Display

- **Chipset:** SMI SM712 2D graphic Chip (built-in 4MB display memory)
- **Memory Size:** built-in 4MB display memory on SMI SM712
- **Resolution:** VGA Display mode: pixel resolution up to 1024 x 768 at 85-Hz and 1024 x 768 at 75-Hz LCD Display mode
- **TTL:** 1 x 24-bit TTL
- **LVDS:** 1x18/24-bit LVDS
- **Dual Display:** VGA+ LVDS or VGA+ TTL



## 1.3 Specifications

### 1.3.1 Functional Specification

#### Processor

Processor	<p>DM&amp;P Vortex86DX-1.0 GHz SoC</p> <ul style="list-style-type: none"> <li>■ x86 Compatible Processor Core</li> <li>■ 6 stage pipeline</li> <li>■ Floating point unit support</li> <li>■ Embedded I / D Separated L1 Cache :16K I-Cache, 16K D-Cache</li> <li>■ DMA Controller</li> <li>■ Operating Voltage Range: Core voltage: 0.9 V ~ 1.1V</li> <li>■ I / O voltage: 1.8V <math>\pm</math> 5% , 3.3 V <math>\pm</math> 10 %</li> <li>■ Package Type: 27x27, 581 Ball BGA</li> <li>■ Manufacturing Technology:90nm</li> </ul>
-----------	--

#### VGA Chipset (SMI SM712)

Graphic and Video Controllers	<p>SMI SM712 2D graphic Chip          VRAM: 4 MB internal memory          Graphic Engine:          62.5MHz single clock/cycle engine (EM+)          86MHz single clock/cycle engine (EM4+)          Designed to accelerate DirectDraw</p>
Output Interfaces	<p>VGA: Supports up to 1024 x 768 @85Hz          LVDS: Supports up to 1024 x 768 @ 24-bit LVDS LCD Panel          TTL: Supports up to 1024 x 768 @ 24-bit TTL LCD Panel          Dual Display: VGA + LVDS and VGA+TTL, support extended mode and clone mode</p> <p>Note: TTL &amp; LVDS can't output at the same time.</p>

## Chipset (DM&P Vortex86DX)

Memory	Supports onboard DDR2 333 SDRAM Memory 256MB/512MB
LAN	LAN1: DM&P Vortex86DX, LAN2: Realtek RTL8110SC(PCM-9343FG) <ul style="list-style-type: none"><li>■ Integrated IEEE 802.3/802.3u compliant</li><li>■ Support 10/100Mbps.</li></ul> Connectors: Phone Jack RJ45 8P 90D(F)
Serial ports	DM&P Vortex86DX SoC supports: <ul style="list-style-type: none"><li>■ 4 full function serial ports from EVA-X5800 SoC</li><li>■ Supports IRQ Sharing among serial ports</li></ul> Connectors: COM1/3/4: (RS-232) 1x DB9 at coastline, 2 x 2.0mm box header COM2: (RS-232/422/485) 1 x 2.0mm box header
USB Interface	DM&P Vortex86DX SoC supports: 4 USB 2.0 ports which are high-speed, full- speed, and low-speed capable USB Connector:(USB1~4) 2 set 5 x 2-pin Hirose DF13 type
SATA Connector	By ACARD chip supports IDE to SATA SATA connectors: Connector: Serial ATA II 7 pins 1.27 mm x 1
Keyboard/Mouse connectors	DM&P Vortex86DX SoC supports: PS/2 Keyboard and Mouse interface. Connector: Box header 6P 2.0mm
GPIO	DM&P Vortex86DX SoC supports <ul style="list-style-type: none"><li>■ 16 I/O Pins.</li></ul> Connectors: 16 pins 2.0mm pin header.
Battery backup	2 pin wafer box for external Battery on board
BIOS	Award 16Mb Flash BIOS via SPI

### 1.3.2 Mechanical Specification

#### 1.3.2.1 Dimension(mm)

L146.00 mm \* W102 mm

#### 1.3.2.2 Height on Top(mm)

14.6 mm (PS/2 Connector)

#### 1.3.2.3 Height on Bottom(mm)

6.70 mm (CF Socket)

#### 1.3.2.4 Weight(g) with Heatsink

132g

### 1.3.3 Electrical Specification

#### 1.3.3.1 Power Supply Voltage

Voltage requirement with AT Power :

+5 V  $\pm 5\%$ , +12 V  $\pm 5\%$  (Optional), (5 V only, 12 V optional for PC/104 add on card and LCD inverter)

#### 1.3.3.2 Power Supply Current

Supply Current (AT)

- Typical mode:

PCM-9343FG-S6A1E: 5 V : 1.08 A

PCM-9343F-S6A1E: 5V : 0.91 A

PCM-9343L-S6A1E: 5V : 0.58 A

- Max load in HCT:

PCM-9343FG-S6A1E: 5 V : 1.18 A

PCM-9343F-S6A1E: 5V : 1.09 A

PCM-9343L-S6A1E: 5V : 0.746 A

#### 1.3.3.3 RTC Battery

Typical Voltage : 3.0 V

Normal discharge capacity : 210 mAh

## 1.4 Environmental Specification

#### 1.4.0.1 Operating Humidity

Operating Humidity: 10% ~ 90% Relative Humidity, non-condensing

#### 1.4.0.2 Operating Temperature

Operating temperature: 0 ~ 60°C (32~140°F)

#### 1.4.0.3 Storage Humidity

Standard products (0 ~ 60°C)

Relative Humidity: 95% @ 60°C

#### 1.4.0.4 Storage Temperature

Standard products (0 ~ 60°C)

Storage temperature: -20~70°C



# Chapter 2

## H/W installation

This chapter explains the setup procedures of the PCM-9343 hardware, including instructions on setting jumpers and connecting peripherals, switches, indicators and mechanical drawings. Be sure to read all safety precautions before you begin the installation procedure.

## 2.1 Jumpers

### 2.1.1 Jumper List

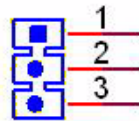
**Table 2.1: Jumper list**

J1	LCD Power
J2	VBR_Ctrl
J3	COM2 Setting
J4	HDD & PWR LED Setting

### 2.1.2 Jumper Settings

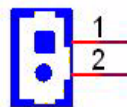
**Table 2.2: J1: LCD Power**

<b>Part Number</b>	1653003101
<b>Footprint</b>	HD_3x1P_79_D
<b>Description</b>	PIN HEADER 3*1P 180D(M) 2.0mm DIP SQUARE W/O Pb
<b>Setting</b>	<b>Function</b>
(1-2)	+3.3V
(2-3)	+5V



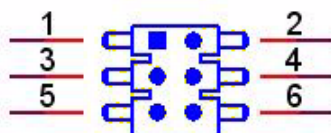
**Table 2.3: J2: VBR\_Ctrl**

<b>Part Number</b>	1653002101
<b>Footprint</b>	HD_2x1P_79_D
<b>Description</b>	PIN HEADER 2*1P 180D(M)SQUARE 2.0mm DIP W/O Pb
<b>Setting</b>	<b>Function</b>
(1-2)	Brightness Control(PWM OUT)

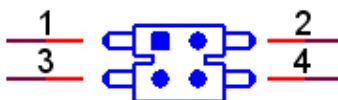


**Table 2.4: J3: COM2 Setting**

<b>Part Number</b>	1653003260
<b>Footprint</b>	HD_3x2P_79
<b>Description</b>	PIN HEADER 3*2P 180D(M) 2.0mm SMD SQUARE PIN
<b>Setting</b>	<b>Function</b>
(1-2)	RS232
(3-4)	RS485
(5-6)	RS422

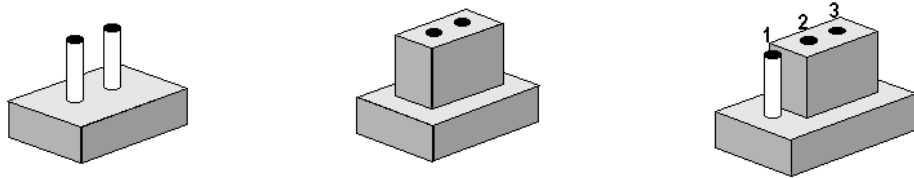
**Table 2.5: J4: HDD & PWR LED Setting**

<b>Part Number</b>	1653000014
<b>Footprint</b>	HD_2x2P_79
<b>Description</b>	PIN HEADER 2*2P 180D SMD MALE SQUARE 2.00mm 0
<b>Setting</b>	<b>Function</b>
(1-2) (3-4)	IDE(Yellow) Power(Green)
(1-3) (2-4)	IDE(Green) Power(Yellow)



### 2.1.3 Jumper Description

You may configure your card to match the needs of your application by setting jumpers. A jumper is a metal bridge used to close an electric circuit. It consists of two metal pins and a small metal clip (often protected by a plastic cover) that slides over the pins to connect them. To close a jumper, you connect the pins with the clip. To open a jumper, you remove the clip. Sometimes a jumper will have three pins, labeled 1, 2 and 3. In this case you would connect either pins 1 and 2, or 2 and 3.



The jumper settings are schematically depicted in this manual as follows.



A pair of needle-nose pliers may be helpful when working with jumpers. If you have any doubts about the best hardware configuration for your application, contact your local distributor or sales representative before you make any changes. Generally, you simply need a standard cable to make most connections.

**Warning!** To avoid damaging the computer, always turn off the power supply before setting jumpers. Clear CMOS. Before turning on the power supply, set the jumper back to 3.0 V Battery On.



### 2.1.4 External SPI Flash

The board provides optional onboard external SPI flash up to 4MB for bootable devices and small storage using DOS Operating System. If required, please contact with Advantech's sales rep to support onboard external SPI flash by request, and follows below steps to enable external SPI flash.

1. If you want to function external SPI flash as storage for read/ write in DOS OS, please adjust BIOS SETUP \Advanced Chipset Features\Virtual Disk to "Enabled". and then use "SPITool.exe" in Drive CD to format it, so that you can read/write external SPI flash.
2. If you want to function external SPI flash as bootable device in DOS OS, please make a DOS bootable disk in CF card or IDE hard drive, boot from DOS bootable disk and then perform format A: /s to the external SPI flash. Next, set BIOS SETUP\ Boot Device to "FLOPPY", so that you can boot from external SPI DOS OS.



## 2.2 Connectors

### 2.2.1 Connector list

**Table 2.6: Connector list**

CN1	SATA
CN2	LPT
CN3	24 bits TTL Panel
CN4	24 bits LVDS Panel
CN5	COM3
CN6	JTAG
CN7	Inverter Power Output
CN8	Internal USB
CN9	Internal USB
CN10	ISA -5V & -12V Input
CN11	AT Power Input
CN12	GPIO
CN13	PC104
CN14	GPIO
CN15	SMBus
CN16	BIOS Socket
CN17	COM4
CN18	LAN2
CN19	COM2
CN20	LAN1
CN21	PS2
CN22	VGA
CN23	COM1
CN24	CF

### 2.2.2 Connector Settings

#### 2.2.2.1 SATA Connector (CN1)

PCM-9343 supports Serial ATA via one connectors (CN1). It transfers by Acard chips and enabling very fast data and file transfer.

#### 2.2.2.2 LPT Connector (CN2)

PCM-9343 can support LPT via CN2. LPT (Line Print Terminal) is the original, yet still common, name of the parallel port interface on IBM PC-compatible computers. It was designed to operate a text printer that used IBM's 8-bit extended ASCII character set.

### 2.2.2.3 VGA/TTL/LVDS Interface Connections

The PCM-9343's VGA interface can drive conventional CRT displays and is capable of driving LVDS and TTL flat panel displays. The board has three connectors to support these displays: one for standard CRT VGA monitors, one for LVDS type LCD panels, another one for LVDS type LCD panels.

PCM-9343 uses SMI SM712 2D graphic chip offering enhanced capabilities for dual view and for handling dual applications, VGA+TTL, and VGA +LVDS, while dual independent display, each display can support independent full screen full motion video, as well as independent graphics refresh rates, resolutions, and color depths.

LVDS and TTL can support resolutions of 640 x 480, 800 x 480, 800 x 600, and 1024 x 768.

#### VGA display connector (CN22)

The VGA display connector is a box connector used for conventional VGA displays.

#### LVDS LCD panel connector (CN4)

The board supports 24-bit LVDS LCD panel displays. Users can connect to a 24-bit LVDS LCD through it.

#### TTL LCD panel connector (CN3)

The board supports 24-bit TTL LCD panel displays. Users can connect to a 24-bit TTL LCD through it.

#### Note!



1. *TTL & LVDS can't be output at the same time.*
2. *In DOS mode, PCM-9343 can't display full screen at 1024 X768 resolution.*
3. *The suggested maximum cable length for TTL is around 40cm, for LVDS is around 10m*

### 2.2.2.4 COM Port Connector (CN5, CN17, CN19, CN23)

The PCM-9343 provides 4 serial ports (COM1, COM3 & COM4: RS-232; COM2: RS-232/422/485) in one DB-9 connector (CN23) for COM1 and one 7\*2P pin header (CN19) for COM2 and two 5\*2P pin header(CN5,CN17) for COM3 & COM4. It provides connections for serial devices (a mouse, etc.) or a communication network. You can find the pin assignments for the COM port connector in Appendix A.

#### COM RS-232/422/485 setting (J3)

COM2 can be configured to operate in RS-232, RS-422, or RS-485 mode.

This is done via J3.

J3	COM2 Setting
Setting	Function
(1-2)	RS232
(3-4)	RS485
(5-6)	RS422

### 2.2.2.5 JTAG Connector (CN6)

The PCM-9343 provides one 6-pin JTAG connector for initial BIOS flash purpose through specific BIOS flash tool.

### 2.2.2.6 Inverter Power connector (CN7)

PCM-9343 can provide +5 V and +12 V and signal to LCD inverter board via CN7.

**2.2.2.7 USB Connectors (CN8, CN9)**

The board provides up to four USB (Universal Serial Bus) ports. This gives complete Plug and Play, and hot attach/detach for up to 127 external devices. The USB interfaces comply with USB specification Rev. 2.0 which supports 480 Mbps transfer rate, and are fuse protected.

There are 5 x 2 pin 180D (M) connectors for internal use, 4 x USB ports CN8, CN9. You will need an adapter cable if you use a standard USB connector. On one end the adapter cable has a 5 x 2-pin connector with a foolproof connection to prevent it from being plugged in the wrong way and on the other end a USB connector.

**2.2.2.8 Main power connector, (CN11)**

PCM-9343 can support 5V AT power supply. Supplies main power +5 V to the PCM-9343, and to devices that require +12 V.

**2.2.2.9 GPIO (General Purpose Input Output) (CN14)**

The board supports 16-bit GPIO through GPIO connector. The 16 digital in and outputs can be programmed to read or control devices, with input or output defined. The default setting is 8 bits input and 8 bits output.

**2.2.2.10 PC/104 Connector (CN13)**

PCM-9343 supports full ISA compatible functions via PC/104 connector (CN13).

20 x 2 (F) 2.54 mm 51.86 mm x 5.01 mm x 11.45 mm p = 3.40 mm

32 x 2 (F) 2.54 mm 82.34 mm x 5.01 mm x 11.45 mm p = 3.40 mm

PC/104 negative voltage: One 3 \* 1P pin header (CN10) supports -5 V/-12 V power input for ISA devices.

**2.2.2.11 SMBus Connector (CN15)**

The System Management Bus (abbreviated to SMBus or SMB) is a simple two-wire bus, derived from I2C and used for communication with low-bandwidth devices on a motherboard, especially power related chips such as a laptop's rechargeable battery subsystem (see Smart Battery Data). Other devices might include temperature, fan or voltage sensors, lid switches and clock chips. PCI add-in cards may connect to a SMBus segment.

The SMBus was defined by Intel in 1995. It carries clock, data, and instructions and is based on Philips' I2C serial bus protocol. Its clock frequency range is 10 kHz to 100kHz. Its voltage levels and timings are more strictly defined than those of I2C, but devices belonging to the two systems are often successfully mixed on the same bus.

**2.2.2.12 Ethernet Configuration(CN18,CN20)**

The board is equipped with 2 high performance 32-bit PCI-bus Ethernet interface which is fully compliant with IEEE 802.3 10/100Mbps. It is supported by all major network operating systems.

**LAN1 Connector (CN20)**

DM&P Vortecx86DX Integrate Fast Ethernet MAC and Physical chip to provide the Fast Ethernet Control unit that has 32-bit performance, PCI bus master capability, and full compliance with IEEE 802.3u 100Bast-T specifications and IEEE 802.3x Full Duplex Flow Control. LAN1 connection adopts Vortecx86DX Integrated Fast Ethernet Control unit on CN24 through internal 10-pin right angle pin header.

**LAN2 Connector (CN18, PCM-9343FG only)**

PCM-9343 LAN2 connection uses the Realtek RTL8100C 10/100Mbps LAN chip via PCI bus and through internal 10-pin right angle pin header.

### 2.2.2.13 Keyboard and PS/2 Mouse Connector (CN21)

The board provides a keyboard connector that supports both a keyboard and a PS/2 style mouse. In most cases, especially in embedded applications, a keyboard is not used. If the keyboard is not present, the standard PC/AT BIOS will report an error or fail during power-on self-test (POST) after a reset. The product's BIOS standard setup menu allows you to select "All, But Keyboard" under the "Halt On" selection. This allows no-keyboard operation in embedded system applications, without the system halting under POST.

### 2.2.2.14 Solid State Disk

The board provides a CompactFlash card type I/II socket.

#### CompactFlash (CN24)

The CompactFlash card shares a secondary IDE channel which can be enabled/disabled via the BIOS settings. Compact Flash set as fix master mode.

## 2.3 Mechanical

### 2.3.1 Jumper and Connector Location

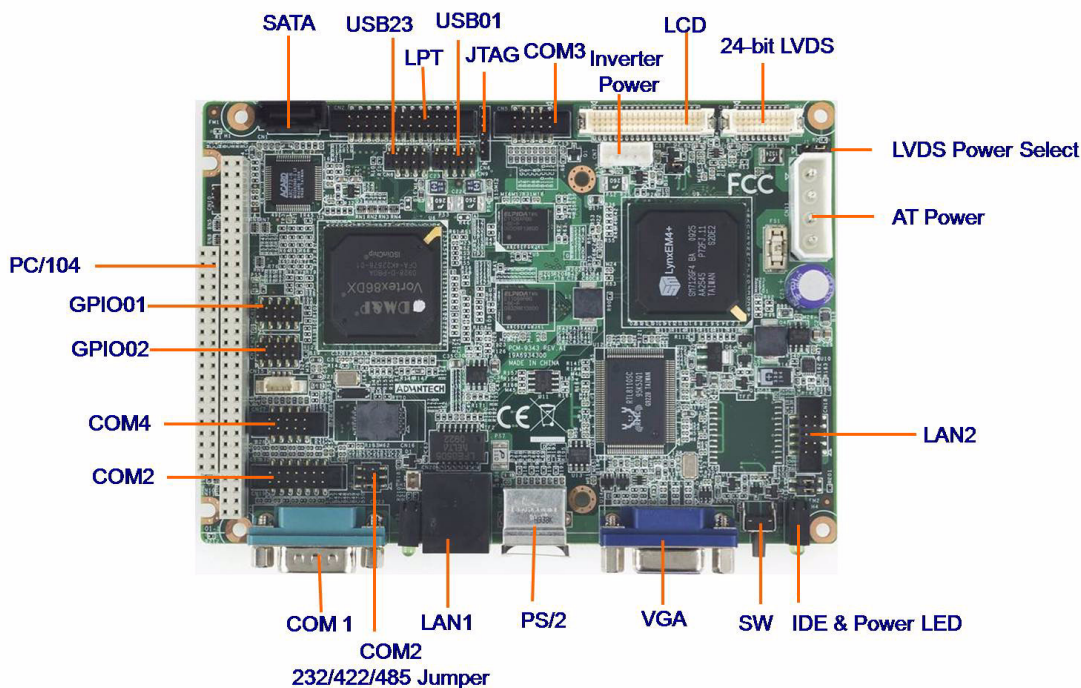


Figure 2.1 Jumper and Connector layout (Component side)

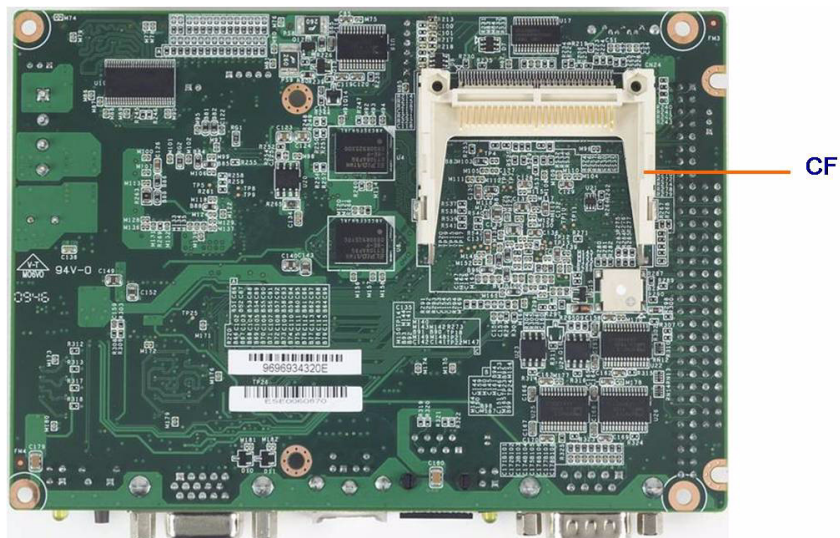


Figure 2.2 Jumper and Connector layout (Solder side)

### 2.3.2 Board Dimension

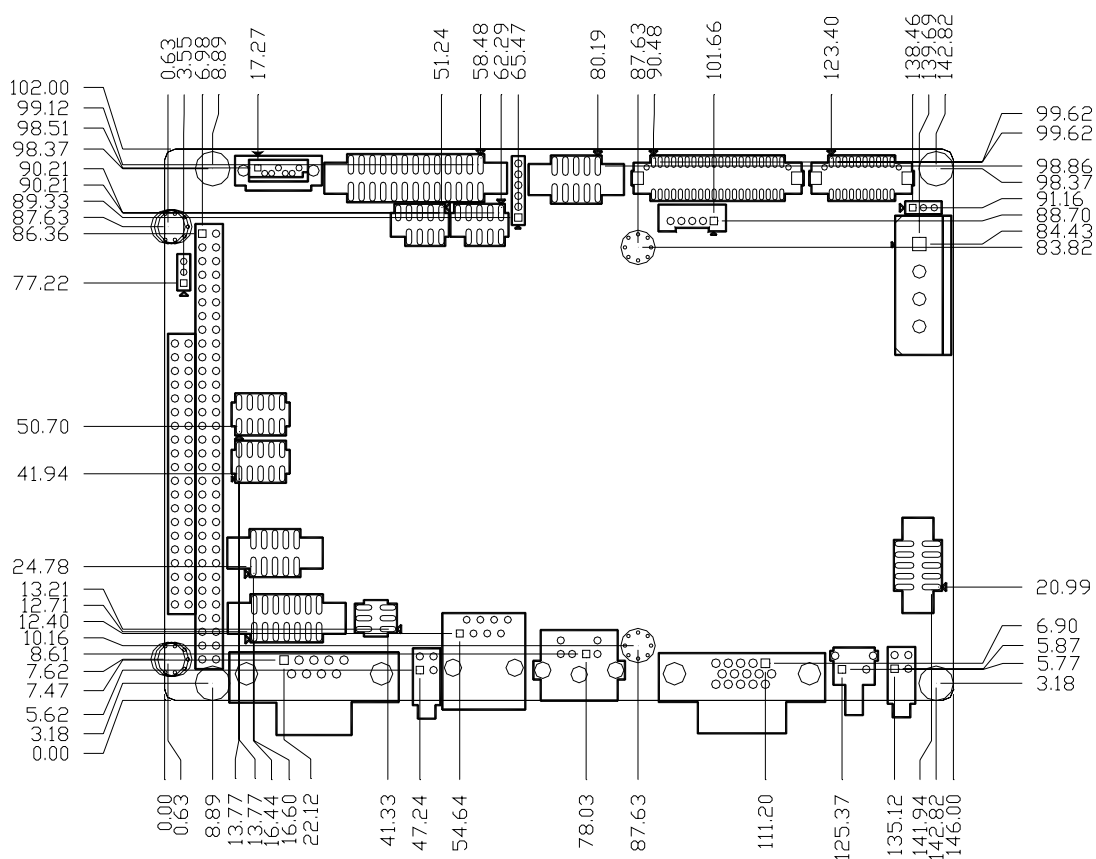
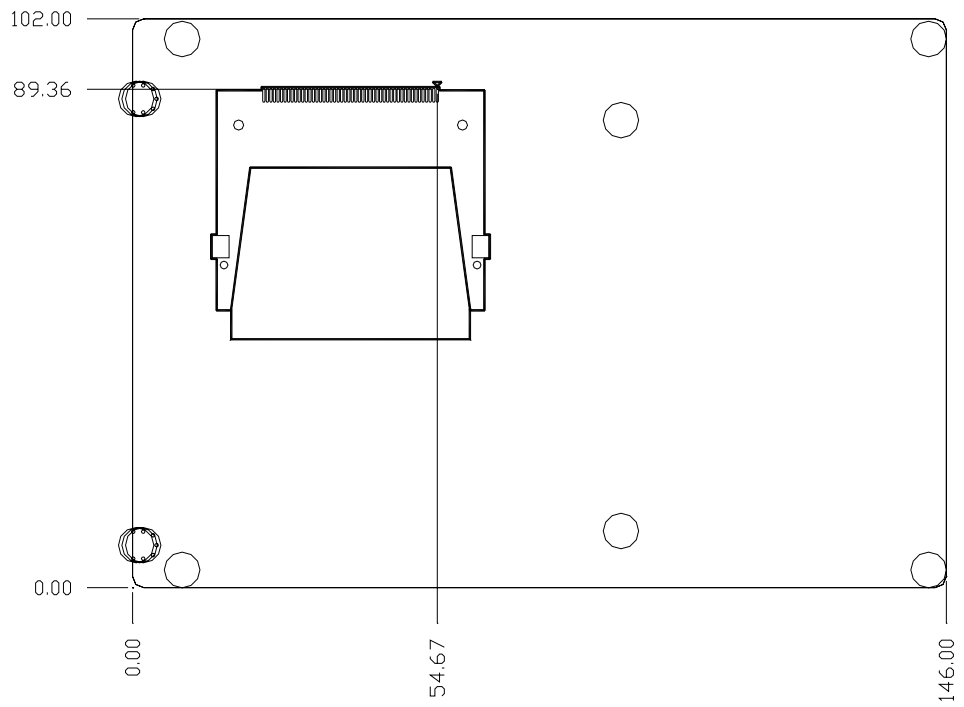
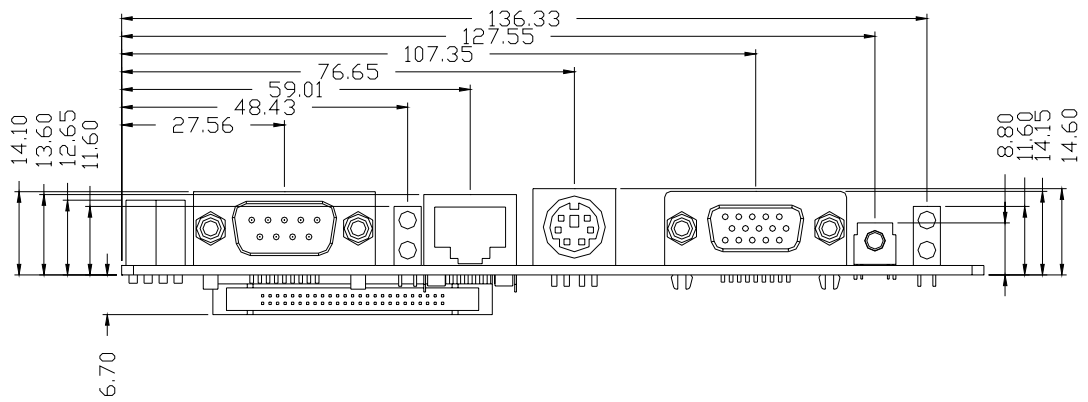


Figure 2.3 Board Dimension layout (Component side)



**Figure 2.4 Board Dimension layout (Solder side)**



**Figure 2.5 Board Dimension layout (Coastline)**

# Chapter 3

BIOS Operation

## 3.1 BIOS Introduction

AwardBIOS 6.0 is a full-featured BIOS provided by Advantech to deliver superior performance, compatibility, and functionality to industrial PCs and embedded boards. Its many options and extensions let you customize your products to a wide range of designs and target markets.

The modular, adaptable AwardBIOS 6.0 supports the broadest range of third-party peripherals and all popular chipsets, plus Intel, AMD, nVidia, VIA, and compatible CPUs from 386 through Pentium, AMD Geode, K7 and K8 (including multiple processor platforms), and VIA Eden C3 and C7 CPUs.

You can use Advantech's utilities to select and install features that suit your needs and your customers' needs.

## 3.2 BIOS Setup

The PCM-9343 system has AwardBIOS 6.0 built-in, which includes a CMOS SETUP utility that allows users to configure settings as required or to activate certain system features.

The CMOS SETUP saves configuration settings in the CMOS RAM of the motherboard. When the system power is turned off, the onboard battery supplies the necessary power to the CMOS RAM so that settings are retained.

To access the CMOS SETUP screen, press the <Del> button during the power-on BIOS POST (Power-On Self Test).

CMOS SETUP Navigation and Control Keys:

< ↑ >< ↓ >< ← >< → >	Move to highlight item
<Enter>	Select Item
<Esc>	Main Menu - Start Quit sequence Sub Menu - Exit the current page and return to level above
<Page Up/+>	Increase the numeric value or make changes
<Page Down/->	Decrease the numeric value or make changes
<F1>	General help, for Setup Sub Menu
<F2>	Item Help
<F5>	Load Previous Values
<F7>	Load Optimized Default
<F10>	Save all CMOS changes



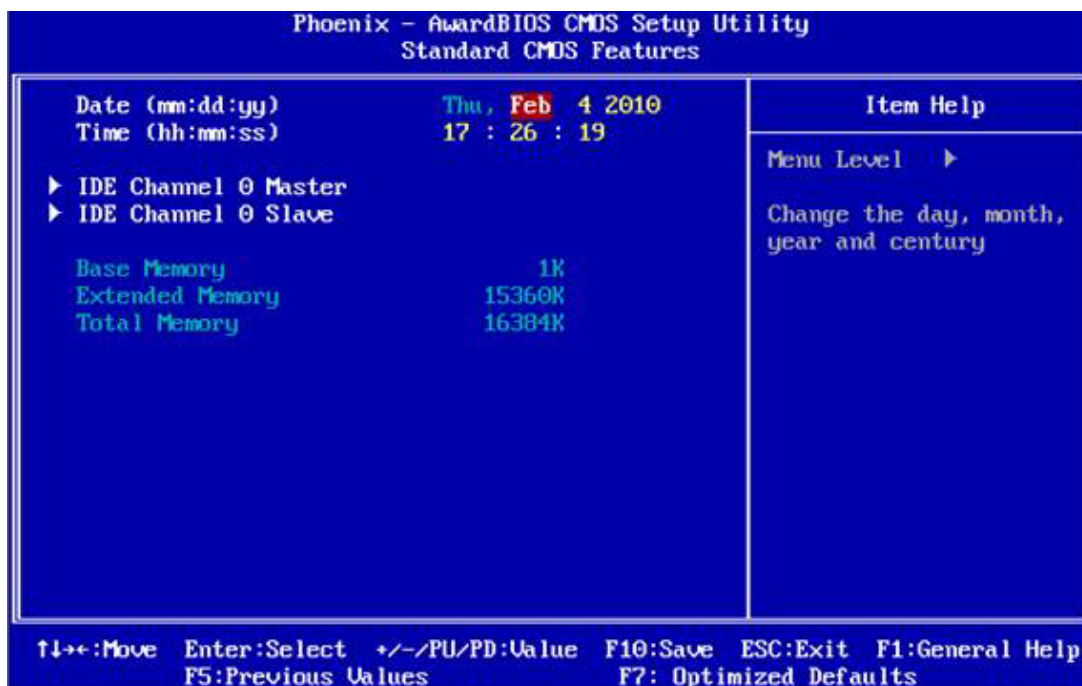
### 3.2.1 Main Menu

Press the <Del> key during startup to enter the BIOS CMOS Setup Utility; the Main Menu will appear on the screen. Use arrow keys to highlight the desired item, and press <Enter> to accept, or enter the sub-menu.



- **Standard CMOS Features**  
This setup page includes all the features for standard CMOS configuration.
- **Advanced BIOS Features**  
This setup page includes all the features for advanced BIOS configuration.
- **Advanced Chipset Features**  
This setup page includes all the features for advanced chipset configuration.
- **Integrated Peripherals**  
This setup page includes all onboard peripheral devices.
- **PnP/PCI Configurations**  
This setup page includes PnP OS and PCI device configuration.
- **Load Optimized Defaults**  
This selection loads optimized values for best system performance configuration.
- **Set Password**  
Establish, change or disable passwords.
- **Save & Exit Setup**  
Save CMOS value settings to CMOS and exit BIOS setup.
- **Exit Without Saving**  
Abandon all CMOS value changes and exit BIOS setup.

## 3.2.2 Standard CMOS Features



- **Date**

The date format is <weekday>, <month>, <day>, <year>.

Weekday	From Sun to Sat, determined and display by BIOS only
Month	From Jan to Dec.
Day	From 1 to 31
Year	From 1999 through 2098
- **Time**

The times format in <hour> <minute> <second>, base on the 24-hour time.
- **IDE Channel 0/1 Master/Slave**

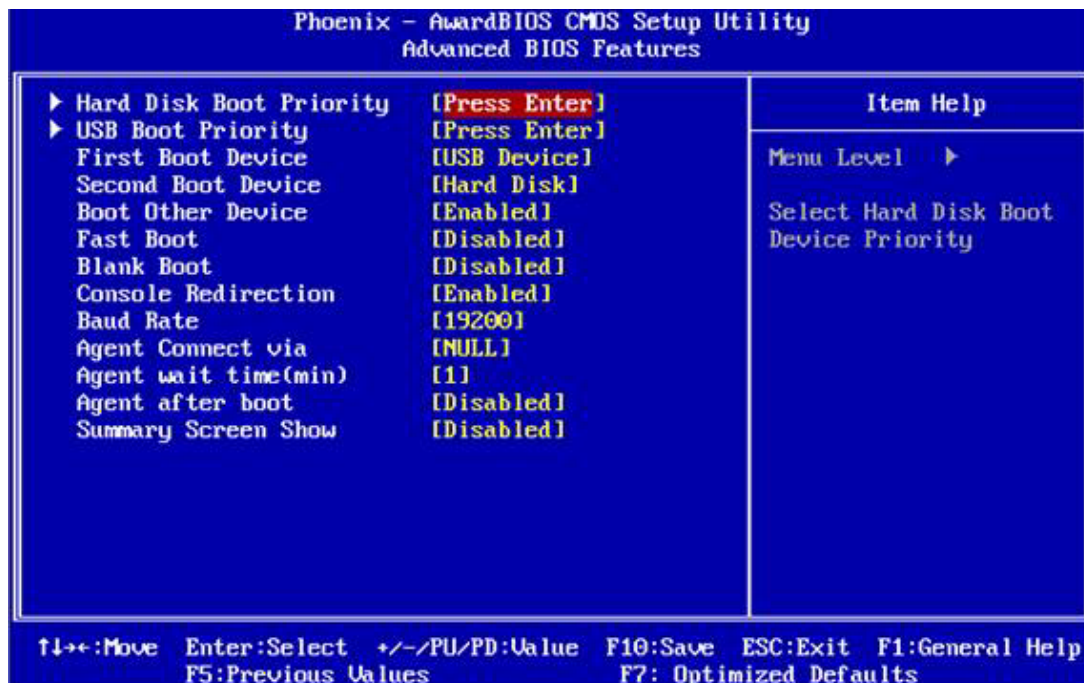
IDE HDD Auto-Detection - Press "Enter" for automatic device detection.
- **Base Memory**

The POST of the BIOS will determine the amount of base (or conventional) memory installed in the system.
- **Extended Memory**

The POST of the BIOS will determine the amount of extended memory (above 1 MB in CPU's memory address map) installed in the system.
- **Total Memory**

This item displays the total system memory size.

### 3.2.3 Advanced BIOS Features

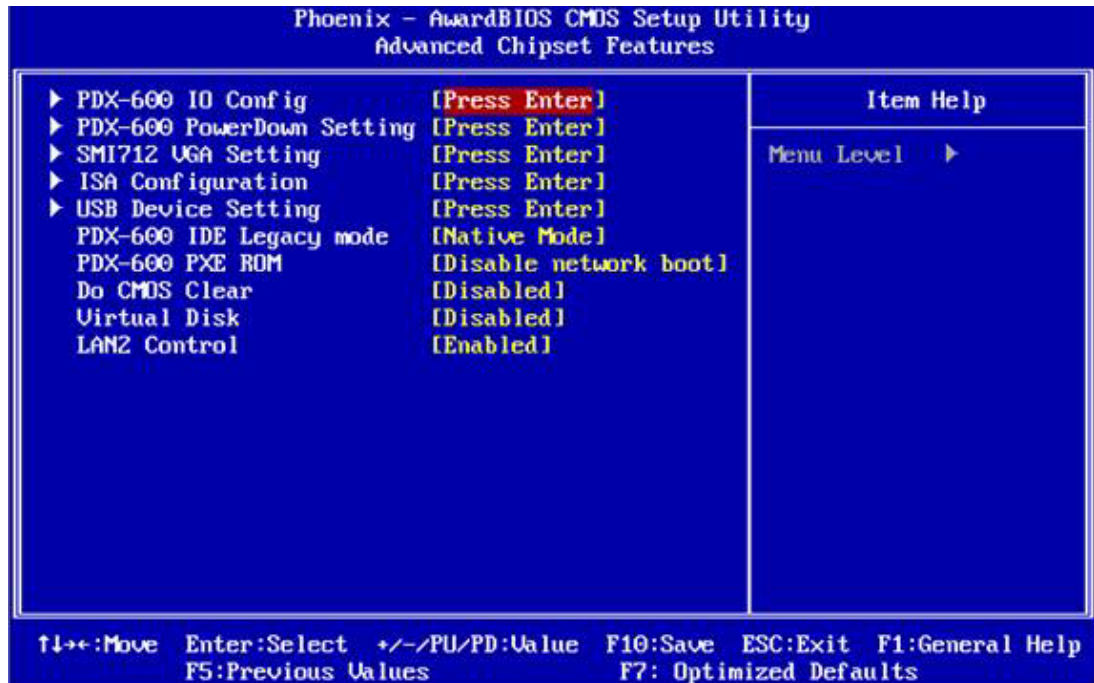


- **Hard Disk Boot Priority [Press Enter]**  
This item allows user to choose the bootable Hard Drive.
- **Hard Disk Boot Priority [Press Enter]**  
This item allows user to choose the bootable USB device.
- **First / Second / Third / Other Boot Drive**

Floppy	Select boot device priority by Floppy.
Hard Disk	Select boot device priority by Hard Disk.
CDROM	Select boot device priority by CDROM.
USB-Device	Select boot device priority by USB-Device.
USB-FDD	Select boot device priority by USB-FDD.
USB-ZIP	Select boot device priority by USB-ZIP.
USB-CDROM	Select boot device priority by USB-CDROM.
LAN	Select boot device priority by LAN.
Disabled	Disable this boot function.
- **Fast Boot [Disabled]**  
This item enable/disable Fast Boot feature.
- **Blank Boot [Disabled]**  
This item enable/disable Blank Boot feature.
- **Console Redirection [Disabled]**  
This item allows a user to enable / disable console redirection mode.
- **Baud Rate [19200]**  
This item allows a user to set baud rate modes.
- **Agent Connect via [NULL]**  
This item allows a user to set agent connect modes.
- **Agent wait time(min) [1]**  
This item allows a user to set agent wait time (min).

- **Agent after boot** [Disabled]  
This item allows user to set agent running after boot mode.
- **Summary Screen Show** [Disabled]  
Show all Mother Board information on POST.

### 3.2.4 Advanced Chipset Features



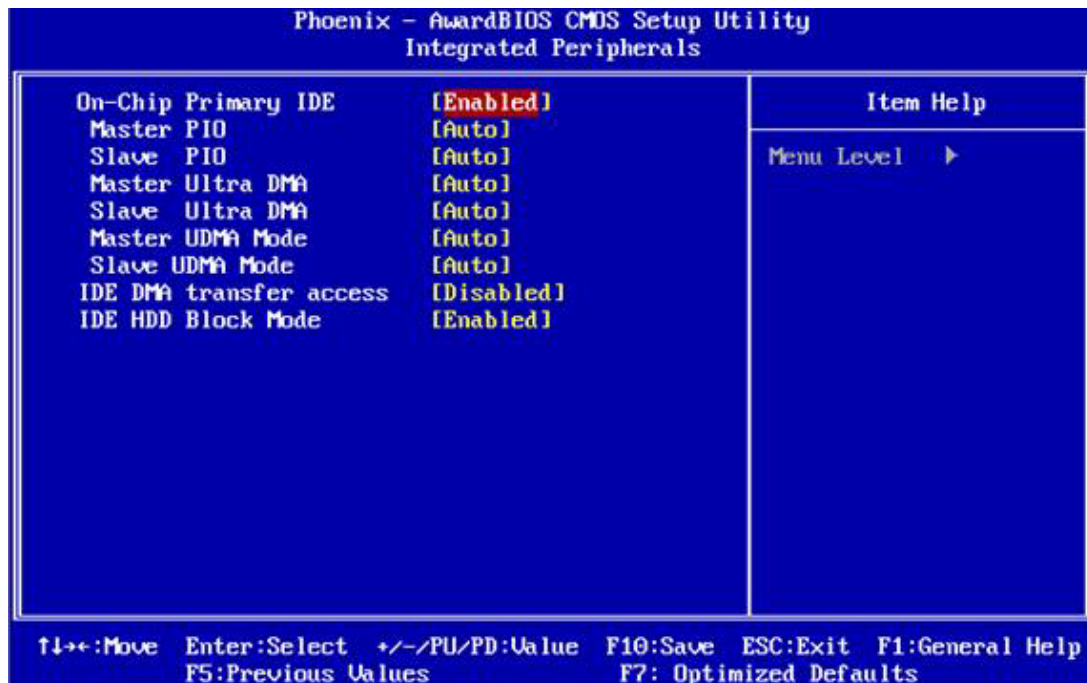
**Note!** *The "Advanced Chipset Features" screen controls the configuration of the board's chipset register settings and performance tuning - the options on this screen may vary depending on the chipset type. It is strongly recommended that only technical users make changes to the default settings.*




- **PDX-600 IO Config** [Press Enter]  
This item allows a user to set EVA5800 UART resources.
- **PDX-600 PowerDown Setting** [Press Enter]  
This item allows a user to set LAN1 powerdown function.
- **SMI712 VGA Setting** [Press Enter]  
This item allows a user to set VGA related features.
- **ISA Configuration** [Press Enter]  
This item allows users to config ISA resources & IO/MEM wait state.
- **USB Device Setting** [Press Enter]  
This item allows users to set USB related features.
- **PDX-600 IDE Legacy mode**[Legacy Mode]  
This item enables EVA-5800 IDE as legacy or native mode:  
legacy mode--- using for DOS/ WinCE  
native mode--- using for WinXP
- **PDX-600 PXE ROM** [Disabled network boot]  
This item allows user to enabled LAN1 PXE boot function.
- **DO CMOS Clear** [Disabled]  
This item allows a user to clear CMOS.

- **Virtual Disk [Disabled]**  
This item allows user to enabled or disabled External SPI as a boot device .
- **LAN2 Control [Enabled]**  
This item is enabled or disabled that onboard of LAN2 controller.

### 3.2.5 Integrated Peripherals

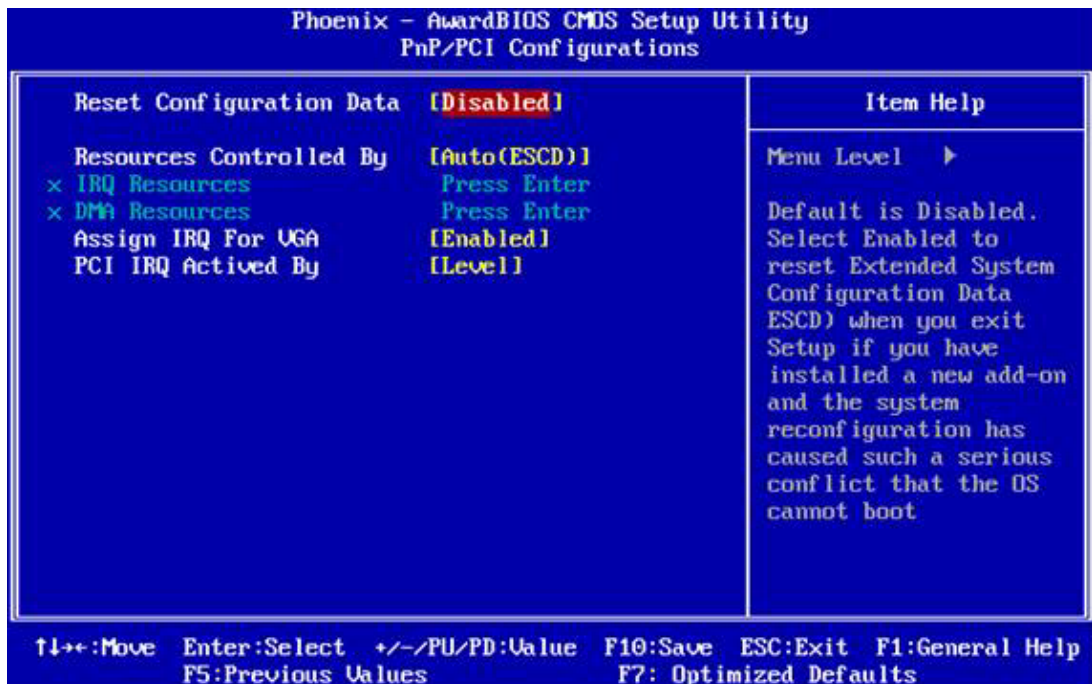


**Note!**  The "Integrated Peripherals" screen controls chipset configuration for IDE, ATA, SATA, USB, AC97, MC97 and Super IO and Sensor devices. The options on this screen vary depending on the chipset.

- **On-Chip Primary IDE [Enabled]**  
This item enables users to set the OnChip IDE device status.
- **Master PIO [Auto]**  
This item allows a user to adjust master IDE mode status for modification purpose. The BIOS default value is set to "Auto".
- **Slave PIO [Auto]**  
This item allows a user to adjust slave IDE mode of type for modification purpose. The BIOS default value is set to "Auto".
- **Master Ultra DMA [Auto]**  
This item allows a user to adjust primary master IDE mode of type for modification purpose. The BIOS default value is set to "Auto".
- **Slave Ultra DMA [Auto]**  
This item allows a user to adjust primary slave IDE mode of type for modification purpose. The BIOS default value is set to "Auto".
- **Master UDMA Mode [Auto]**  
This item allows a user to adjust primary master IDE mode of type for modification purpose. The BIOS default value is set to "Auto".
- **Slave UDMA Mode [Auto]**  
This item allows a user to adjust primary slave IDE mode. The BIOS default value is set to "Auto".

- **IDE DMA transfer access [Disabled]**  
This item allows a user to adjust IDE DMA mode. It will increase IDE Data transfer of speed. The BIOS default value is set to "Enabled".
- **IDE HDD Block Mode [Enabled]**  
The IDE block data transfer mode will speed up HDD data transfer more efficiently. The BIOS default value is set to "Enabled".

### 3.2.6 PnP/PCI Configurations

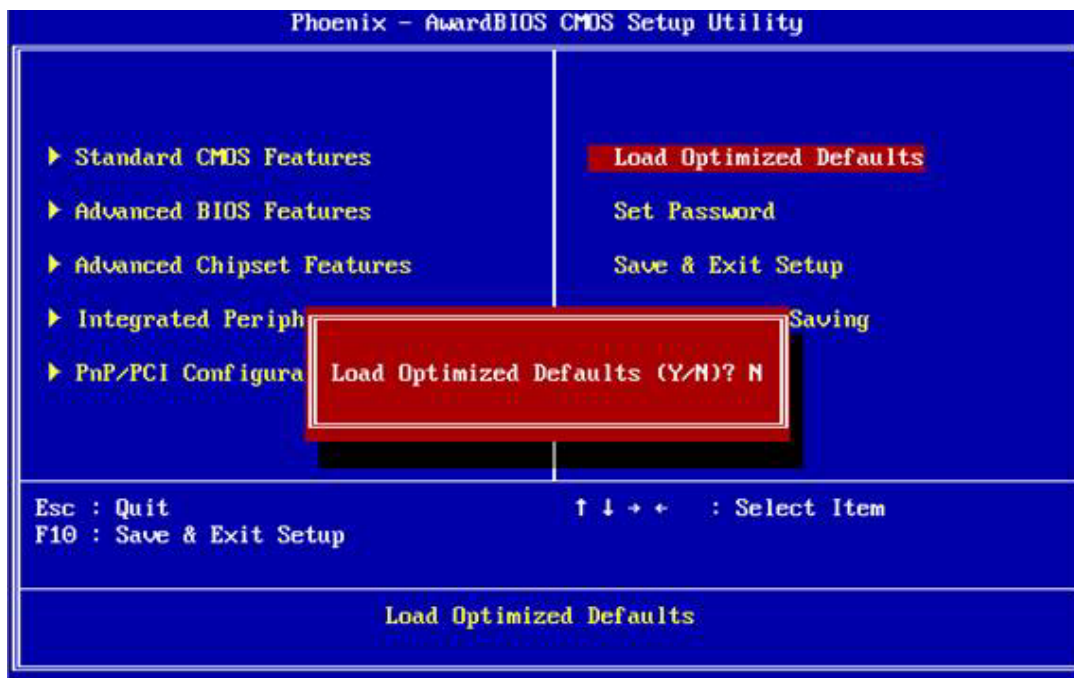


**Note!** This "PnP/PCI Configurations" option sets up the IRQ and DMA (both PnP and PCI bus assignments).



- **Reset Configuration Data° [Disabled]**  
This item allow a user to clear any PnP configuration data stored in the BIOS.
- **Resources Controlled By [Auto (ESCD)]**
  - **IRQ Resources**  
This item allows assignment of an interruptive type for IRQ-9, 10, 11, 14, and 15.
  - **DMA Resources**  
This item allows you to respectively assign a DMA for 0, 1, 3, 5, 6, and 7.
- **Assign IRQ For VGA [Enabled]**  
The item is designed to solve problems caused by some non-standard VGA cards. A built-in VGA system does not need this function.
- **PCI IRQ Activated By [Level]**  
The item allows users to choose level or edge.

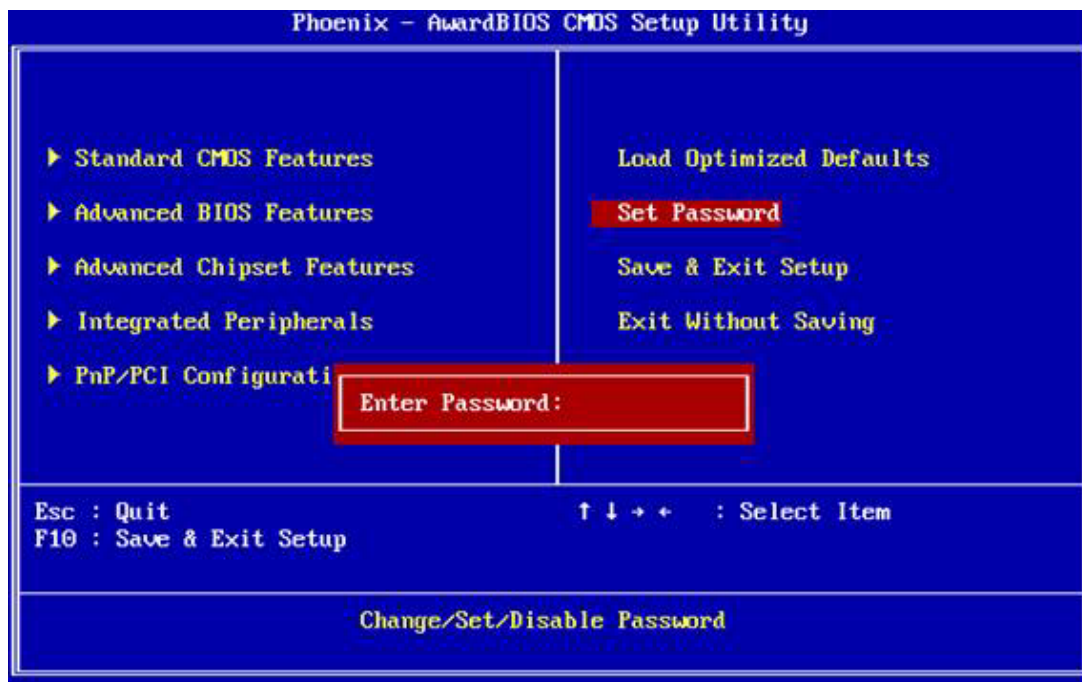
### 3.2.7 Load Optimized Defaults




**Note!** *"Load Optimized Defaults" loads the default system values directly from ROM. If the stored record created by the setup program should ever become corrupted (and therefore unusable), select Load Setup Defaults to have these default values load automatically for the next bootup.*



### 3.2.8 Set Password



---

**Note!**  To enable this feature, you should first go to the "Advanced BIOS Features" menu, choose the Security Option, and select either System or Setup, depending on which aspects you want password protected. System requires a password both to boot the system and to enter Setup. Setup requires a password only to enter Setup. A password may be at most 8 characters long.

#### **To Establish Password**

1. Choose the Set Password option from the CMOS Setup Utility Main Menu and press <Enter>.
2. When you see Enter Password, enter the desired password and press <Enter>.
3. At the Confirm Password prompt, retype the desired password, then press <Enter>.
4. Select Save to CMOS and exit, type <Y>, then <Enter>.

#### **To Change Password**

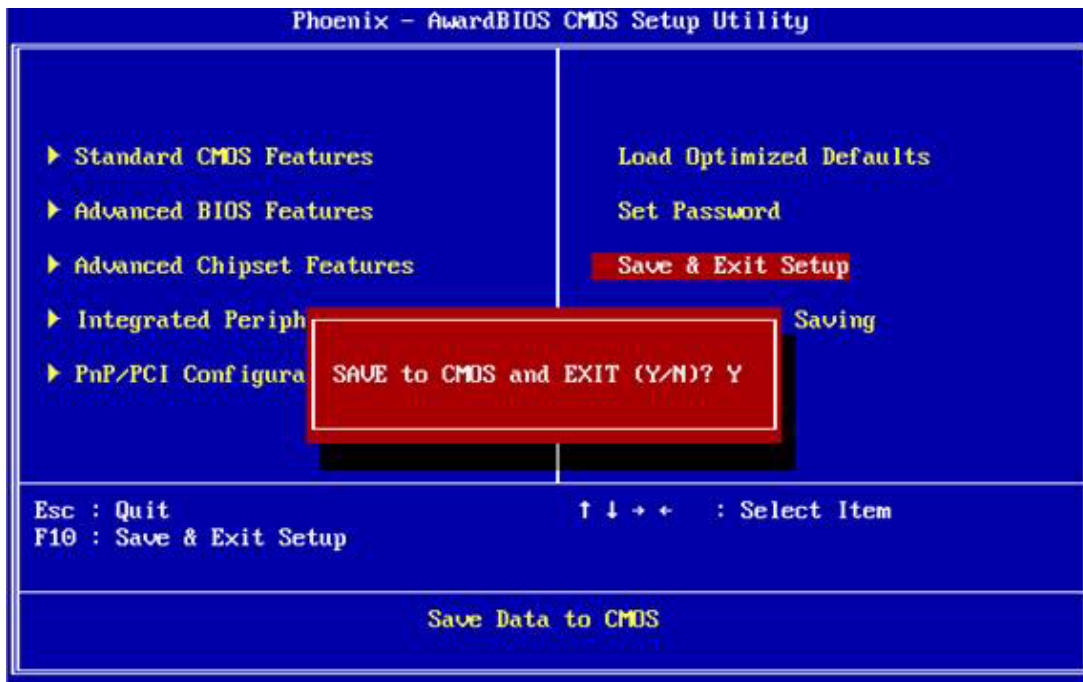
1. Choose the Set Password option from the CMOS Setup Utility main menu and press <Enter>.
2. When you see Enter Password, enter the existing password and press <Enter>.
3. You will see the Confirm Password prompt, type it in again, and press <Enter>.
4. Select Set Password again, and at the Enter Password prompt, enter the new password and press <Enter>.
5. At the Confirm Password prompt, retype the new password, and press <Enter>.
6. Select Save to CMOS and exit, type <Y>, then <Enter>.

#### **To Disable a Password**

1. Choose the Set Password option from the CMOS Setup Utility main menu and press <Enter>.
2. When you see the Enter Password prompt, enter the existing password and press <Enter>.
3. You will see Confirm Password, type it in again, and press <Enter>.
4. Select Set Password again, and at the Enter Password prompt, DO NOT enter anything - just press <Enter>.
5. At the Confirm Password prompt, again, DO NOT type in anything - just press <Enter>.
6. Select Save to CMOS and exit, type <Y>, then <Enter>.



### 3.2.9 Save & Exit Setup

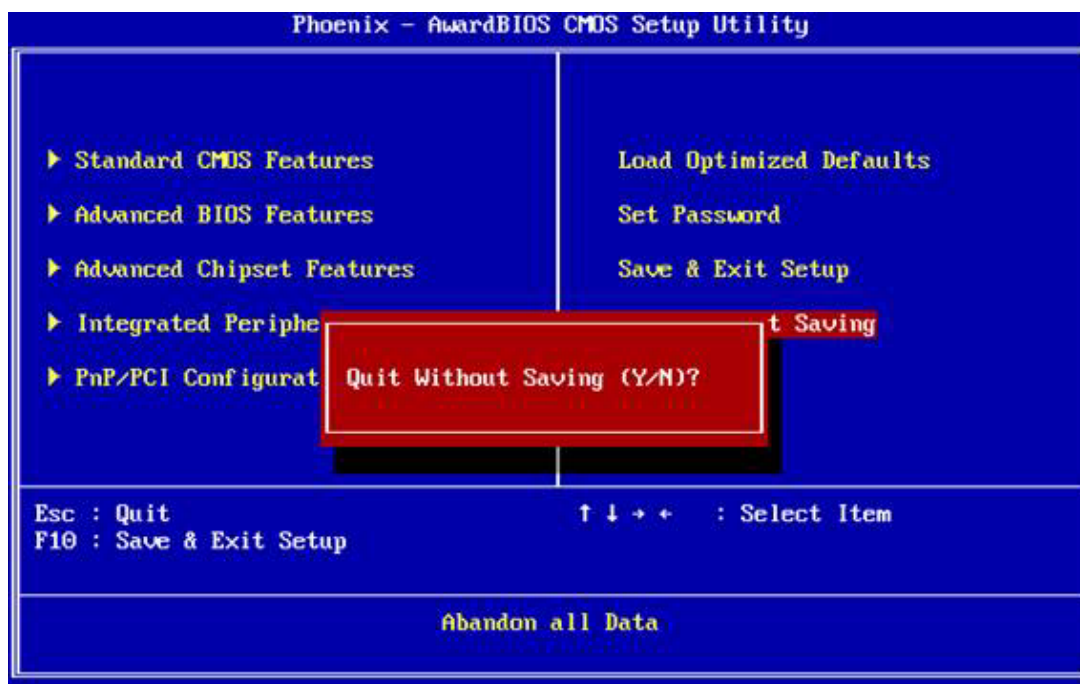


**Note!** Typing "Y" will quit the BIOS Setup Utility and save user setup values to CMOS.



Typing "N" will return to BIOS Setup Utility.

### 3.2.10 Quit Without Saving



**Note!** Typing "Y" will quit the BIOS Setup Utility without saving any changes to CMOS.



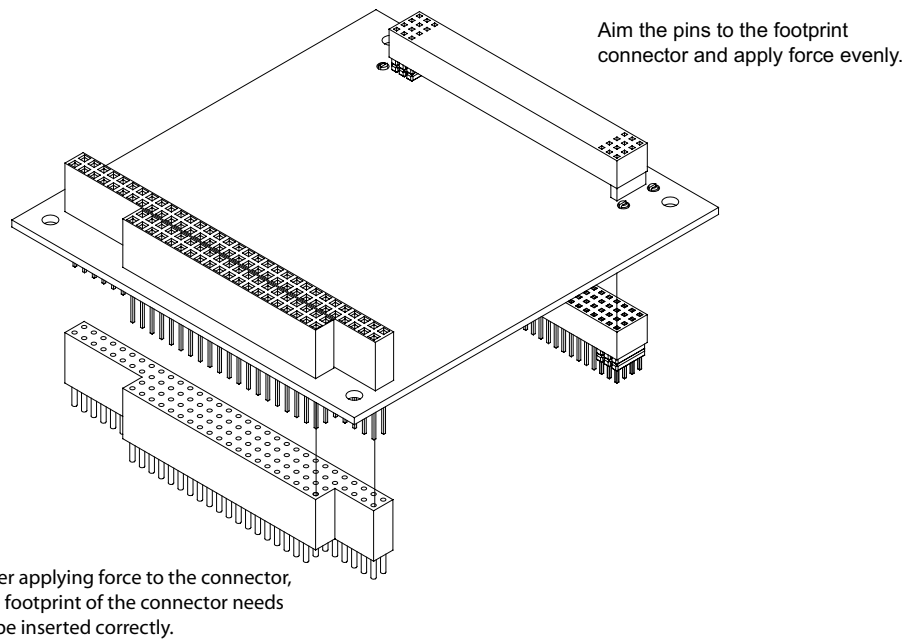
Typing "N" will return to the BIOS Setup Utility.



# Chapter 4

Extension I/O  
Installation

## 4.1 PC/104



# Chapter 5

S/W Introduction &  
Installation

---

## 5.1 S/W Introduction

The mission of Advantech Embedded Software Services is to "Enhance quality of life with Advantech platforms and Microsoft Windows? embedded technology." We enable Windows Embedded software products on Advantech platforms to more effectively support the embedded computing community. Customers are freed from the hassle of dealing with multiple vendors (Hardware suppliers, System integrators, Embedded OS distributor) for projects. Our goal is to make Windows Embedded Software solutions easily and widely available to the embedded computing community.

## 5.2 Driver Installation

To install the drivers please just insert the CD into CD-Rom, select the drivers that you want to install, then run .exe (set up) file under each chipset folder and follow Driver Setup instructions to complete the installation.

### 5.2.1 Windows XP Professional

To install the drivers for Windows XP Professional, insert the CD into the CD-Rom, it will auto-detect the hardware platform and then pop up with the "Embedded Computing Install Wizard box; just select the drivers that you want to install then click Install All Selected drivers. Follow the Driver Setup Wizard instructions; click "Next" to complete the installation.

### 5.2.2 Other OS

To install the drivers for another Windows OS or Linux, please browse the CD to run the setup file under each chipset folder on the CD-ROM.

## 5.3 Value-Added Software Services

Software API: An interface that defines the ways by which an application program may request services from libraries and/or operating systems. Provides not only the underlying drivers required but also a rich set of user-friendly, intelligent and integrated interfaces, which speeds development, enhances security and offers add-on value for Advantech platforms. It plays the role of catalyst between developer and solution, and makes Advantech embedded platforms easier and simpler to adopt and operate with customer applications.

### 5.3.1 SUSI Introduction

To make hardware easier and convenient to access for programmers, Advantech has released a suite of API (Application Programming Interface) in the form of a program library. The program Library is called Secured and Unified Smart Interface or SUSI for short.

In modern operating systems, user space applications cannot access hardware directly. Drivers are required to access hardware. User space applications access hardware through drivers. Different operating systems usually define different interface for drivers. This means that user space applications call different functions for hardware access in different operating systems. To provide a uniform interface for accessing hardware, an abstraction layer is built on top of the drivers and SUSI is such an abstraction layer. SUSI provides a uniform API for application programmers to access the hardware functions in different Operating Systems and on different Advantech hardware platforms.

Application programmers can invoke the functions exported by SUSI instead of calling the drivers directly. The benefit of using SUSI is portability. The same set of API is defined for different Advantech hardware platforms. Also, the same set of API is implemented in different Operating Systems including Windows XP and Windows CE. This user's manual describes some sample programs and the API in SUSI. The hardware functions currently supported by SUSI can be grouped into a few categories including Watchdog, I<sup>2</sup>C, SMBus, GPIO, and VGA control. Each category of API in SUSI is briefly described below.

## 5.3.2 Software APIs

### 5.3.2.1 The GPIO API

General Purpose Input/Output is a flexible parallel interface that allows a variety of custom connections. It allows users to monitor the level of signal input or set the output status to switch on/off a device. Our API also provides Programmable GPIO, which allows developers to dynamically set the GPIO input or output status.

### 5.3.2.2 The I<sup>2</sup>C API

I<sup>2</sup>C is a bi-directional two-wire bus that was developed by Philips for use in their televisions in the 1980s and nowadays is used in various types of embedded systems. The strict timing requirements defined in the I<sup>2</sup>C protocol has been taken care of by SUSI. Instead of asking application programmers to figure out the strict timing requirements in the I<sup>2</sup>C protocol, the I<sup>2</sup>C API in SUSI can be used to control I<sup>2</sup>C devices by invoking other function calls. SUSI provides a consistent programming interface for different Advantech boards. That means user programs using SUSI are portable among different Advantech boards as long as the boards and SUSI provide the required functionalities. Overall product development times can be greatly reduced using SUSI.

### 5.3.2.3 The Display Control API

There are two kinds of VGA control APIs, backlight on/off control and brightness control. Backlight on/off control allows a developer to turn on or off the backlight, and to control brightness smoothly.

1. Brightness Control
  - The Brightness Control API allows a developer to interface with an embedded device to easily control brightness.
2. Backlight Control
  - The Backlight API allows a developer to control the backlight (screen) on/off in an embedded device.

### 5.3.2.4 The Watchdog API

A watchdog timer (abbreviated as WDT) is a hardware device which triggers an action, e.g. rebooting the system, if the system does not reset the timer within a specific period of time. The WDT API in SUSI provides developers with functions such as starting the timer, resetting the timer, and setting the timeout value if the hardware requires customized timeout values.

### 5.3.3 SUSI Utilities

#### 5.3.3.1 BIOS Flash

The BIOS Flash utility allows customers to update the flash ROM BIOS version, or use it to back up current BIOS by copying it from the flash chip to a file on customers' disk. The BIOS Flash utility also provides a command line version and API for fast implementation into customized applications.

#### 5.3.3.2 Embedded Security ID

The embedded application is the most important property of a system integrator. It contains valuable intellectual property, design knowledge and innovation, but it is easily copied! The Embedded Security ID utility provides reliable security functions for customers to secure their application data within embedded BIOS.

#### 5.3.3.3 Flash Lock

Flash Lock is a mechanism that binds the board and CF card (SQFlash) together. The user can "Lock" SQFlash via the Flash Lock function and "Unlock" it via BIOS while booting. A locked SQFlash cannot be read by any card reader or boot from other platforms without a BIOS with the "Unlock" feature.

### 5.3.4 SUSI Installation

SUSI supports many different operating systems. Each subsection below describes how to install SUSI and related software on a specific operating system. Please refer to the subsection matching your operating system.

#### 5.3.4.1 Windows XP

In windows XP, you can install the library, drivers and demo programs onto the platform easily using the installation tool--The SUSI Library Installer. After the installer has executed, the SUSI Library and related files for Windows XP can be found in the target installation directory. The files are listed in the following table.

Directory	Contents
\Library	<ul style="list-style-type: none"><li>■ Susi.lib Library for developing the applications on Windows XP.</li><li>■ Susi.dll Dynamic library for SUSI on Windows XP.</li></ul>
\Demo	<ul style="list-style-type: none"><li>■ SusiDemo.EXE Demo program on Windows XP.</li><li>■ Susi.dll Dynamic library for SUSI on Windows XP.</li></ul>
\Demo\SRC	Source code of the demo program on Windows XP.



The following section illustrates the installation process.

**Note!** *The version of the SUSI Library Installer shown on each screen shot below depends on your own particular version.*



1. Extract SUSI.zip.
2. Double-click the "Setup.exe" file.

The installer searches for a previous installation of the SUSI Library. If it locates one, a screen shot opens asking whether you want to modify, repair or remove the software. If a previous version is located, please see the section of [Maintenance Setup]. If it is not located, the following screen shot opens. Click Next.

#### 5.3.4.2 Windows CE

In windows CE, there are three ways to install the SUSI Library, you can install it manually or use Advantech CE-Builder to install the library or just copy the programs and the library onto a compact flash card.

##### **Express Installation:**

You can use Advantech CE-Builder to load the library into the image.

- First, you click the My Component tab.
- In this tab, you click Add New Category button to add a new category, eg. the SUSI Library.
- Then you can add a new file in this category, and upload the SUSI.dll for this category.
- After these steps, you can select the SUSI Library category you created for every project.

##### **Manual Installation:**

You can add the SUSI Library into the image by editing any bib file.

First you open project.bib in the platform builder.

- Add this line to the MODULES section of project.bib  
Susi.dll \$(\_FLATRELEASEDIR)\Susi.dll NK SH
- If you want to run the window-based demo, add following line:  
SusiTest.exe \$(\_FLATRELEASEDIR)\SusiTest.exe
- If you want to run the console-based demo, add following lines:  
Watchdog.exe \$(\_FLATRELEASEDIR)\Watchdog.exe NK S  
GPIO.exe \$(\_FLATRELEASEDIR)\GPIO.exe NK S  
SMBUS.exe \$(\_FLATRELEASEDIR)\SMBUS.exe NK S
- Place the three files into any files directory.
- Build your new Windows CE operating system.

## 5.3.5 SUSI Sample Programs

### Sample Programs

The sample programs demonstrate how to incorporate SUSI into your program. There are sample programs for two categories of operating system, i.e. Windows XP and Windows CE. The sample programs run in graphics mode in Windows XP and Windows CE. The sample programs are described in the subsections below.

### Windows Graphics Mode

There are sample programs of Windows in graphics mode for two categories of operating system, i.e. Windows CE and Windows XP. Each demo application contains an executable file SusiDemo.exe, a shared library Susi.dll and source code within the release package. The files of Windows CE and Windows XP are not compatible with each other.

SusiDemo.exe is an executable file and it requires the shared library, Susi.dll, to demonstrate the SUSI functions. The source code of SusiDemo.exe also has two versions, i.e. Windows CE and Windows XP, and must be compiled under Microsoft Visual C++ 6.0 on Windows XP or under Microsoft Embedded Visual C++ 4.0 on Windows CE. Developers must add the header file Susi.h and library Susi.lib to their own projects when they want to develop something with SUSI.

### SusiDemo.exe

The SusiDemo.exe test application is an application which uses all functions of the SUSI Library. It has five major function blocks: Watchdog, GPIO, SMBus, I<sup>2</sup>C and VGA control. The following screen shot appears when you execute SusiDemo.exe. You can click function tabs to select test functions respectively. Some function tabs will not show on the test application if your platform does not support such functions. For a complete support list, please refer to Appendix A. We describe the steps to test all functions of this application.



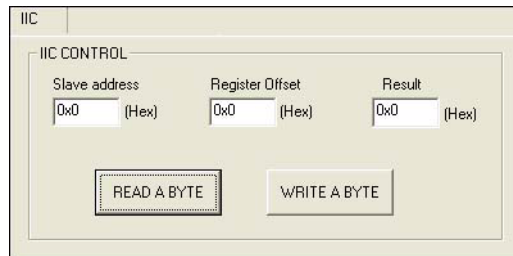
## GPIO

When the application is executed, it will display GPIO information in the GPIO INFORMATION group box. It displays the number of input pins and output pins. You can click the radio button to choose to test either the single pin function or multiple pin functions. The GPIO pin assignments of the supported platforms are located in Appendix B.

- Test Read Single Input Pin
  - Click the radio button- Single-Pin.
  - Key in the pin number to read the value of the input pin. The Pin number starts from '0'.
  - Click the READ GPIO DATA button and the status of the GPIO pin will be displayed in (R/W) Result field.
  
- Test Read Multiple Input Pin
  - Click the radio button- Multiple-Pins.
  - Key in the pin number from '0x01' to '0x0F' to read the value of the input pin. The pin numbers are ordered bitwise, i.e. bit 0 stands for GPIO 0, bit 1 stands for GPIO 1, etc. For example, if you want to read pin 0, 1, and 3, the pin numbers should be '0x0B'.
  - Click READ GPIO DATA button and the statuses of the GPIO pins will be displayed in (R/W) Result field.
  
- Test Write Single Output Pin
  - Click the radio button- Single-Pin.
  - Key in the pin numbers you want to write. Pin numbers start from '0'.
  - Key in the value either '0' or '1' in (R/W) Result field to write the output pin you chose above step.
  - Click the WRITE GPIO DATA button to write the GPIO output pin.
  
- Test Write Multiple Output Pins
  - Click the radio button- Multiple-Pins.
  - Key in the pin number from '0x01' to '0x0F' to choose the multiple pin numbers to write the value of the output pin. The pin numbers are ordered bitwise, i.e. bit 0 stands for GPIO 0, bit 1 stands for GPIO 1, etc. For example, if you want to write pin 0, 1, and 3, the pin numbers should be '0x0B'.

- Key in the value in (R/W) Result field from '0x01' to '0x0F' to write the value of the output pin. The pin numbers are ordered bitwise, i.e. bit 0 stands for GPIO 0, bit 1 stands for GPIO 1, etc. For example, if you want to set pin 0 and 1 high, 3 to low, the pin number should be '0x0B', and then you should key in the value '0x0A' to write.
- Click the WRITE GPIO DATA button to write the GPIO output pins.

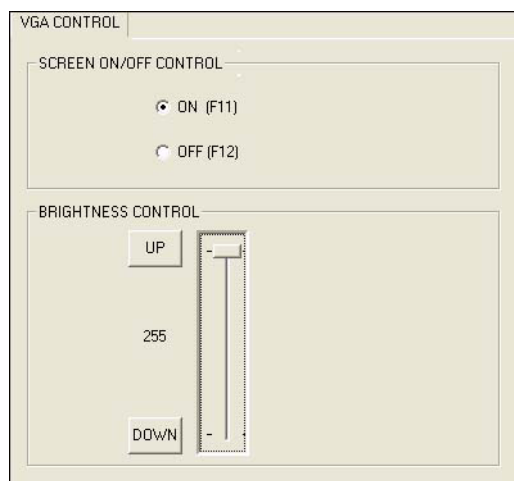
## I<sup>2</sup>C



When the application is executed, you can read or write a byte of data through I<sup>2</sup>C devices. All data must be read or written in hexadecimal system.

- Read a byte
  - Key in the slave device address in Slave address field.
  - Key in the register offset in Register Offset field.
  - Click the READ A BYTE button and then a byte of data from the device will be shown on the Result field.
- Write a byte
  - Key in the slave device address in Slave address field.
  - Key in the register offset in Register Offset field.
  - Key in the desirous of data in Result field to write to the device.
  - Click the WRITE A BYTE button and then the data will be written to the device through I<sup>2</sup>C.

## Display Control



When the application is executed, it will display two blocks of VGA control functions. The application can turn on or turn off the screen shot freely, and it also can tune the brightness of the panels if your platform is being supported. You can test the functionalities of VGA control as follows:

- **Screen on/off control**
  - Click the radio button ON or push the key F11 to turn on the panel screen.
  - Click the radio button OFF or push the key F12 to turn off the panel screen.
  - The display chip of your platform must be in the support list in Appendix A, or this function cannot work.
- **Brightness control**
  - Move the slider in increments, using either the mouse or the direction keys, or click the UP button to increase the brightness.
  - Move the slider in decrements, using either the mouse or the direction keys, or click the DOWN button to decrease the brightness.

## Watchdog

The screenshot shows a software interface for configuring a watchdog timer. It is titled 'WATCHDOG' and contains three main sections:

- WATCHDOG INFORMATION:** This section displays three input fields: 'Min Timeout' with the value '1000' and unit 'ms', 'Max Timeout' with the value '255000' and unit 'ms', and 'Timeout Setp' with the value '1000' and unit 'ms'.
- WATCHDOG SETTING:** This section contains two input fields: 'Set Delay' with the value '2000' and unit 'ms', and 'Set Timeout' with the value '3000' and unit 'ms'.
- WATCHDOG CONTROL:** This section features a 'Timeout Countdown' field showing '0 ms'. Below this field are three buttons: 'START', 'REFRESH', and 'STOP'.

When the application is executed, it will display watchdog information in the WATCHDOG INFORMATION group box. It displays max timeout, min timeout, and timeout steps in milliseconds. For example, a 1~255 seconds watchdog will have 255000 max timeout, 1000 min timeout, and 1000 timeout steps. You can test the functionality of the watchdog as follows:

- Set the timeout value 3000 (3 sec.) in the SET TIMEOUT field and set the delay value 2000 (2 sec.) in the SET DELAY field, then click the START button. The Timeout Countdown field will countdown the watchdog timer and display 5000 (5 sec.).
- Before the timer counts down to zero, you can reset the timer by clicking the REFRESH button. After you click this button, the Timeout Countdown field will display the value of the SET TIMEOUT field.
- If you want to stop the watchdog timer, you just click the STOP button.

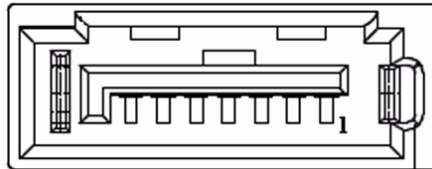
# Appendix **A**

## PIN Assignments

## A.1 PIN Assignments

**Table A.1: CN1: SATA**

<b>Part Number</b>	1654004659
<b>Footprint</b>	SATA_7P_WATM-07DBN4A3B8UW_D
<b>Description</b>	
<b>Pin</b>	<b>Pin Name</b>
1	GND
2	TX+
3	TX-
4	GND
5	RX-
6	RX+
7	GND



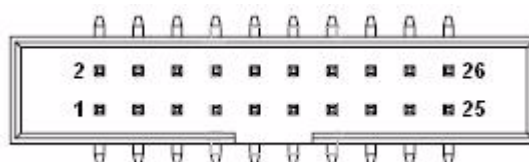
**Table A.2: CN2: LPT**

<b>Part Number</b>	1653213260
<b>Footprint</b>	HD_13x2P_79_BOX
<b>Description</b>	BOX HEADER 13*2P 180D(M) 2.0mm SMD
<b>Pin</b>	<b>Pin Name</b>
1	STROBE#
2	AUTOFEED#
3	D0
4	ERROR#
5	D1
6	INIT#
7	D2
8	SLCT IN#
9	D3
10	GND
11	D4
12	GND
13	D5
14	GND
15	D6
16	GND
17	D7
18	GND
19	ACK#



**Table A.2: CN2: LPT**

20	GND
21	BUSY
22	GND
23	PE
24	GND
25	SLCT
26	NC



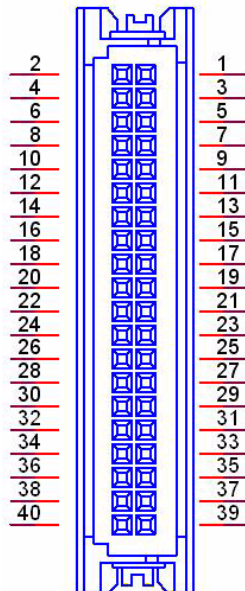
Matching Cable : 1700260250 1700001531

**Table A.3: CN3: 24 bits TTL Panel**

<b>Part Number</b>	1653920200
<b>Footprint</b>	SPH20X2
<b>Description</b>	*CONN. 40P 90D 1.25mm SMD WO/Pb DF13-40DP-1.25V
<b>Pin</b>	<b>Pin Name</b>
1	+5V
2	+5V
3	GND
4	GND
5	+3.3V
6	+3.3V
7	NC
8	GND
9	PD0
10	PD1
11	PD2
12	PD3
13	PD4
14	PD5
15	PD6
16	PD7
17	PD8
18	PD9
19	PD10
20	PD11
21	PD12
22	PD13
23	PD14
24	PD15
25	PD16
26	PD17

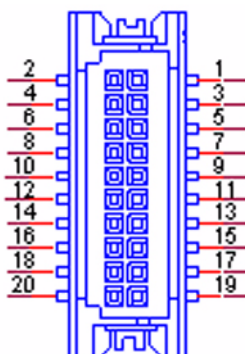
**Table A.3: CN3: 24 bits TTL Panel**

27	PD18
28	PD19
29	PD20
30	PD21
31	PD22
32	PD23
33	GND
34	GND
35	SHFCLK
36	FLM (V-SYNC)
37	M/DE
38	LP (H-SYNC)
39	NC
40	ENVEE



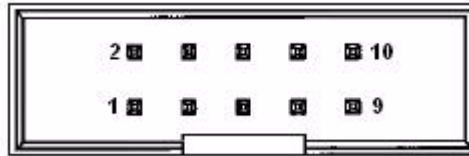
**Table A.4: CN4: 24 bits LVDS Panel**

<b>Part Number</b>	1653910261
<b>Footprint</b>	SPH10X2
<b>Description</b>	*CONN. SMD 10*2P 180D(M)DF13-20DP-1.25V(91) HRS
<b>Pin</b>	<b>Pin Name</b>
1	GND
2	GND
3	LVDS0_D0+
4	NC
5	LVDS0_D0-
6	NC
7	LVDS0_D1+
8	NC
9	LVDS0_D1-
10	NC
11	LVDS0_D2+
12	NC
13	LVDS0_D2-
14	NC
15	LVDS0_CLK+
16	NC
17	LVDS0_CLK-
18	NC
19	+5V or +3.3V
20	+5V or +3.3V



**Table A.5: CN5: COM3**

<b>Part Number</b>	1653205260
<b>Footprint</b>	HD_5x2P_79_BOX
<b>Description</b>	BOX HEADER SMD 5*2 180D (M) 2.0mm
<b>Pin</b>	<b>Pin Name</b>
1	DCD#
2	DSR#
3	RXD
4	RTS#
5	TXD
6	CTS#
7	DTR#
8	RI#
9	GND
10	GND



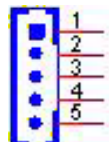
Matching Cable: 1700100250

**Table A.6: CN6: JTAG**

<b>Part Number</b>	1653006101
<b>Footprint</b>	HD_6x1P_79_D
<b>Description</b>	PIN HEADER 6*1P 180D(M) SQUARE 2.0mm
<b>Pin</b>	<b>Pin Name</b>

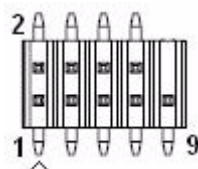
**Table A.7: CN7: Inverter Power Output**

<b>Part Number</b>	1655000453
<b>Footprint</b>	WHL5V-2M-24W1140
<b>Description</b>	WAFER BOX 2.0mm 5P 180D(M) DIP WO/pb JIH VEI
<b>Pin</b>	<b>Pin Name</b>
1	+12V
2	GND
3	ENABKL
4	VBR
5	+5V



**Table A.8: CN8: Internal USB**

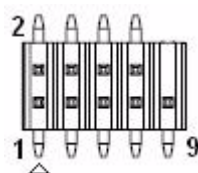
<b>Part Number</b>	1653005260
<b>Footprint</b>	HD_5x2P_79_N10
<b>Description</b>	PIN HEADER 2*5P 180D(M) 2.0mm SMD IDIOT-PROOF
<b>Pin</b>	<b>Pin Name</b>
1	+5V
2	+5V
3	A_D-
4	B_D-
5	A_D+
6	B_D+
7	GND
8	GND
9	GND



Matching Cable: 1703100121

**Table A.9: CN9: Internal USB**

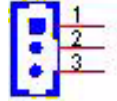
<b>Part Number</b>	1653005260
<b>Footprint</b>	HD_5x2P_79_N10
<b>Description</b>	PIN HEADER 2*5P 180D(M) 2.0mm SMD IDIOT-PROOF
<b>Pin</b>	<b>Pin Name</b>
1	+5V
2	+5V
3	A_D-
4	B_D-
5	A_D+
6	B_D+
7	GND
8	GND
9	GND



Matching Cable: 1703100121

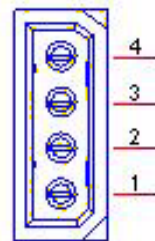
**Table A.10: CN10: ISA -5V & -12V Input**

<b>Part Number</b>	1653003101
<b>Footprint</b>	HD_3x1P_79_D
<b>Description</b>	PIN HEADER 3*1P 180D(M) 2.0mm DIP SQUARE W/O Pb
<b>Pin</b>	<b>Pin Name</b>
1	-12V
2	-5V
3	GND



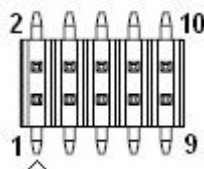
**Table A.11: CN11: AT Power Input**

<b>Part Number</b>	1655204030
<b>Footprint</b>	WF_4P_200_R1_D
<b>Description</b>	HOUSING 5.08mm 4P 180D MALE W/O LOCK
<b>Pin</b>	<b>Pin Name</b>
1	+12V
2	GND
3	GND
4	+5V



**Table A.12: CN12: GPIO**

<b>Part Number</b>	1653005261
<b>Footprint</b>	HD_5x2P_79
<b>Description</b>	PIN HEADER SMD 5*2P 180D(M) 2.0mm
<b>Pin</b>	<b>Pin Name</b>
1	+5V
2	GPIO4
3	GPIO0
4	GPIO5
5	GPIO1
6	GPIO6
7	GPIO2
8	GPIO7
9	GPIO3
10	GND

**Table A.13: CN13: PC104**

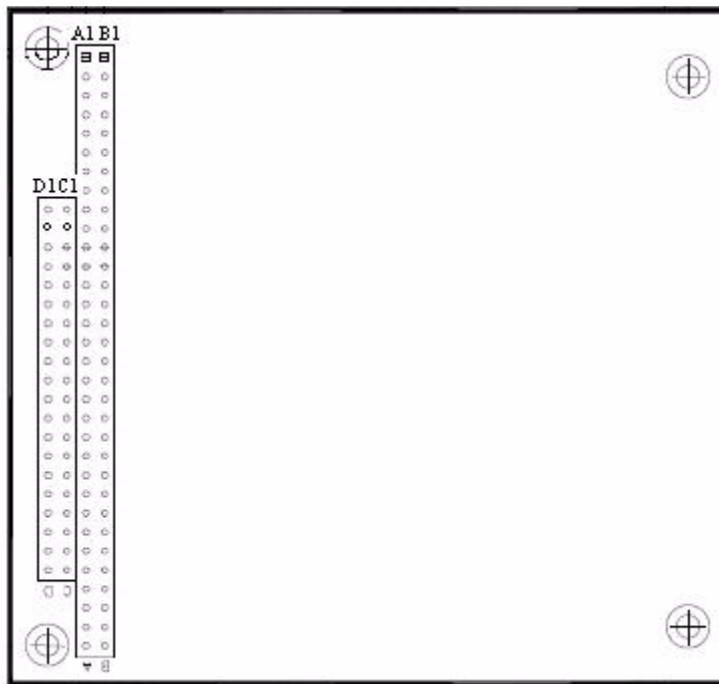
<b>Part Number</b>	00A0000003 165313222A 165312022A
<b>Footprint</b>	PC104A
<b>Description</b>	
<b>Pin</b>	<b>Pin Name</b>
A1	IOCHCK
A2	SD7
A3	SD6
A4	SD5
A5	SD4
A6	SD3
A7	SD2
A8	SD1
A9	SD0
A10	IOCHRDY
A11	AEN
A12	SA19
A13	SA18
A14	SA17
A15	SA16
A16	SA15
A17	SA14
A18	SA13

**Table A.13: CN13: PC104**

A19	SA12
A20	SA11
A21	SA10
A22	SA9
A23	SA8
A24	SA7
A25	SA6
A26	SA5
A27	SA4
A28	SA3
A29	SA2
A30	SA1
A31	SA0
A32	GND
B1	GND
B2	RSTDRV
B3	+5V
B4	IRQ9
B5	-5V
B6	DRQ2
B7	-12V
B8	OWS#
B9	+12V
B10	GND
B11	SMEMW#
B12	SMEMR#
B13	IOW#
B14	IOR#
B15	DACK3#
B16	DRQ3
B17	DACK1#
B18	DRQ1
B19	REFRESH#
B20	SYCLK
B21	IRQ7
B22	IRQ6
B23	IRQ5
B24	IRQ4
B25	IRQ3
B26	DACK2#
B27	TC
B28	ALE#
B29	+5V
B30	OSC
B31	GND
B32	GND
C1	GND

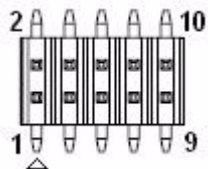


Table A.13: CN13: PC104	
C2	BHE#
C3	LA23
C4	LA22
C5	LA21
C6	LA20
C7	LA19
C8	LA18
C9	LA17
C10	MEMR#
C11	MEMW#
C12	SD8
C13	SD9
C14	SD10
C15	SD11
C16	SD12
C17	SD13
C18	SD14
C19	SD15
C20	NC
D1	GND
D2	MEMCS16#
D3	IOCS16#
D4	IRQ10
D5	IRQ11
D6	IRQ12
D7	IRQ15
D8	IRQ14
D9	DACK0#
D10	DRQ0
D11	DACK5#
D12	DRQ5
D13	DACK6#
D14	DRQ6
D15	DACK7#
D16	DRQ7
D17	+5V
D18	MASTER#
D19	GND
D20	GND



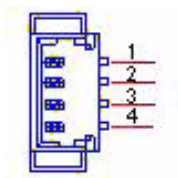
**Table A.14: CN14: GPIO**

<b>Part Number</b>	1653005261
<b>Footprint</b>	HD_5x2P_79
<b>Description</b>	PIN HEADER SMD 5*2P 180D(M) 2.0mm
<b>Pin</b>	<b>Pin Name</b>
1	+5V
2	GPIO4
3	GPIO0
4	GPIO5
5	GPIO1
6	GPIO6
7	GPIO2
8	GPIO7
9	GPIO3
10	GND

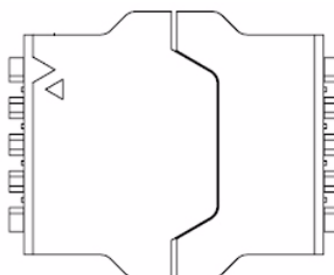


**Table A.15: CN15: SMBus**

<b>Part Number</b>	1655904020
<b>Footprint</b>	FPC4V-125M
<b>Description</b>	Wafer SMT 1.25mmS/T type 4P 180D(M) 85205-04001
<b>Pin</b>	<b>Pin Name</b>
1	GND
2	SMB_DAT
3	SMB_CLK
4	+5V

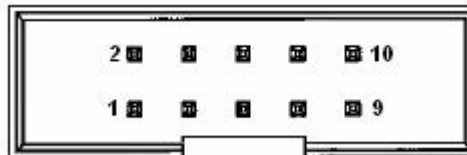
**Table A.16: CN16: BIOS Socket**

<b>Part Number</b>	1651000682
<b>Footprint</b>	SOCKET_8P_ACA-SPI-004-K01
<b>Description</b>	IC SKT 8P SMD WO/Pb C ACA-SPI-004-K01
<b>Pin</b>	<b>Pin Name</b>
1	CE#
2	SO
3	WP#
4	GND
5	SI
6	SCK
7	HOLD#
8	+3.3V



**Table A.17: CN17: COM4**

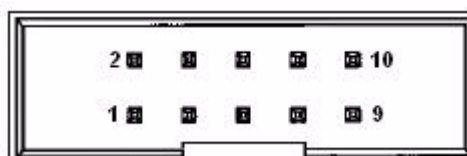
<b>Part Number</b>	1653205260
<b>Footprint</b>	HD_5x2P_79_BOX
<b>Description</b>	BOX HEADER SMD 5*2 180D (M) 2.0mm
<b>Pin</b>	<b>Pin Name</b>
1	DCD#
2	DSR#
3	RXD
4	RTS#
5	TXD
6	CTS#
7	DTR#
8	RI#
9	GND
10	GND



Matching Cable: 1700100250

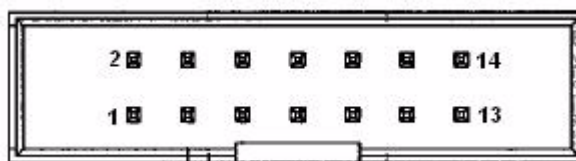
**Table A.18: CN18: LAN2**

<b>Part Number</b>	1653205260
<b>Footprint</b>	HD_5x2P_79_BOX
<b>Description</b>	BOX HEADER SMD 5*2 180D (M) 2.0mm
<b>Pin</b>	<b>Pin Name</b>
1	GNDT
2	GNDT
3	MDI3+
4	MDI3-
5	MDI2+
6	MDI2-
7	MDI1+
8	MDI1-
9	MDI0+
10	MDI0-



**Table A.19: CN19: COM2**

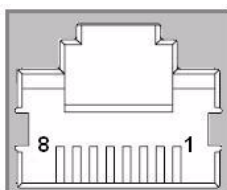
<b>Part Number</b>	1653207260
<b>Footprint</b>	HD_7x2P_79_BOX
<b>Description</b>	BOX HEADER SMD 7*2P 180D(M) 2.0mm
<b>Pin</b>	<b>Pin Name</b>
1	DCD#
2	DSR#
3	RXD
4	RTS#
5	TXD
6	CTS#
7	DTR#
8	RI#
9	GND
10	GND
11	422/485TX+
12	422/485TX-
13	422RX+
14	422RX-



Matching Cable: 1701140201

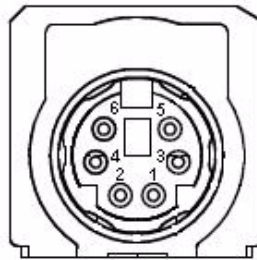
**Table A.20: CN20: LAN1**

<b>Part Number</b>	1652508200
<b>Footprint</b>	RJ45_8P_677-088-D06
<b>Description</b>	PHONE JACK RJ45 8P 90D(F) DIP 677-088-D06
<b>Pin</b>	<b>Pin Name</b>
1	TX+
2	TX-
3	RX+
4	GNDT
5	GNDT
6	RX-
7	GNDT
8	GNDT



**Table A.21: CN21: PS2**

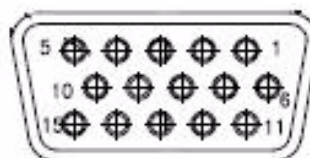
<b>Part Number</b>	1654606317
<b>Footprint</b>	MINIDIN6
<b>Description</b>	MINI DIN 6P 90D(F) DIP W/Shielded Purple w/o cd
<b>Pin</b>	<b>Pin Name</b>
1	KBDAT
2	MSDAT
3	GND
4	+5V
5	KBCLK
6	MSCLK



Matching Cable: 1700060202

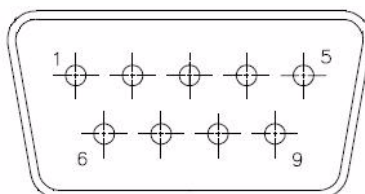
**Table A.22: CN22: VGA**

<b>Part Number</b>	1654515304
<b>Footprint</b>	SUYIN_070207FR015S221CA
<b>Description</b>	D-SUB CONN. 15P 90D(F) DIP 5mm BLUE W/O Pb
<b>Pin</b>	<b>Pin Name</b>
1	RED
2	GREEN
3	BLUE
4	NC
5	GND
6	GND
7	GND
8	GND
9	NC
10	GND
11	NC
12	DDAT
13	HSYNC
14	VSYNC
15	DCLK



**Table A.23: CN23: COM1**

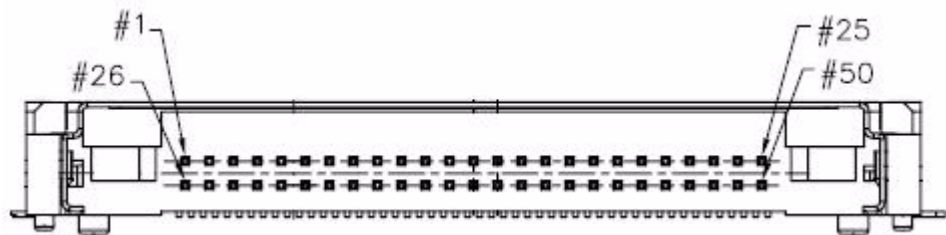
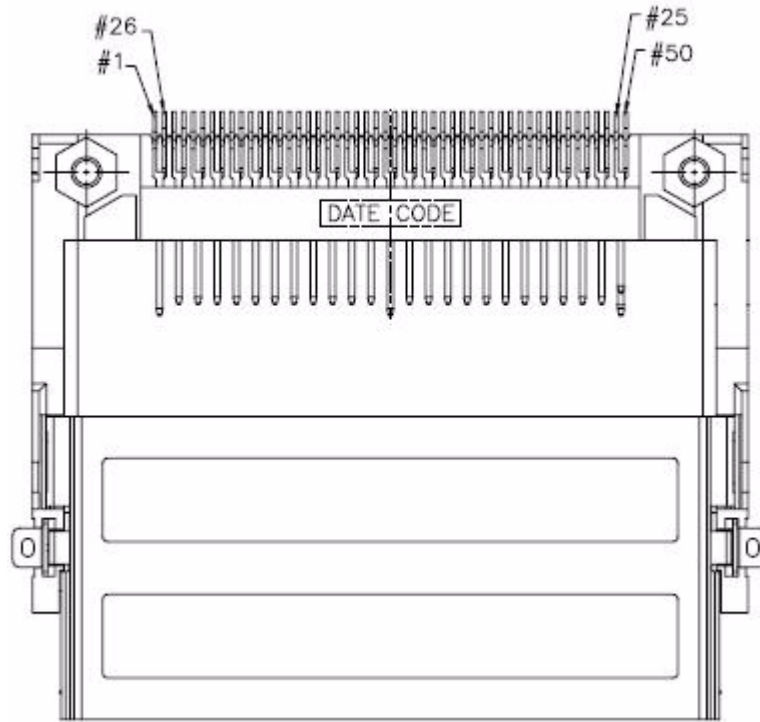
<b>Part Number</b>	1654409108
<b>Footprint</b>	SUYIN_070205MR009S202BA
<b>Description</b>	D-SUB CONN 9P 5mm GRN 90D(M) 070205MR009S202BA
<b>Pin</b>	<b>Pin Name</b>
1	DCD#
2	RXD
3	TXD
4	DTR#
5	GND
6	DSR#
7	RTS#
8	CTS#
9	RI#

**Table A.24: CN24: CF**

<b>Part Number</b>	1653050111
<b>Footprint</b>	COMPACT-60111220
<b>Description</b>	Header CFTypell 50P 90D( M)Standoff2.2mm 60111220 19
<b>Pin</b>	<b>Pin Name</b>
1	GND
2	D03
3	D04
4	D05
5	D06
6	D07
7	CS0#
8	GND
9	GND
10	GND
11	GND
12	GND
13	+5V
14	GND
15	GND
16	GND
17	GND
18	A02
19	A01

**Table A.24: CN24: CF**

20	A00
21	D00
22	D01
23	D02
24	NC
25	CD2#
26	CD1#





# Appendix **B**

## System Assignments

## B.1 System I/O Ports

**Table B.1: System I/O Ports**

Addr. Range (Hex)	Device
00h-1Fh	DMA Controller
20h-21h	Interrupt Controller
40h-48h	Timer/Counter
50h-52h	Timer/Counter
60h	Keyboard controller
64h	Keyboard controller
70h-71h	RTC & CMOS
81h-8Fh	DMA Controller
92h	Reset Generator
A0h-A1h	Interrupt Controller
C0h-DEh	DMA Controller
170h-177h	IDE Controller
1F0h-1F7h	IDE Controller
3F8-3FF	COM Port / LPT
3E8-3EF	
2F8-2FF	
2E8-2EF	
2F0-2F7	
2E0-2E7	
3E0-3E7	
3B8-3BF	
220-227	
228-22F	
238-23F	
278-27F	
338-33F	
378-37F	

## B.2 1st MB memory map

**Table B.2: 1st MB memory map**

Addr. Range (Hex)	Device
F0000h - FFFFFh	Upper BIOS Area (64kB)
E0000h - EFFFFh	Lower BIOS Area (64kB) 16kB x 41
C0000h - DFFFFh	Expansion Card BIOS and Buffer Area (128kB) 16kB x8
A0000h - BFFFFh	Standard PCI/ISA Video Memory (SMM Memory) 128kB
00000h - 9FFFFh	DOS Area

## B.3 DMA channel assignments

**Table B.3: DMA channel assignments**

Channel	Function
0	Available
1	Available
3	Available
5	Available
6	Available
7	Available

## B.4 Interrupt assignments

**Table B.4: Interrupt assignments**

Interrupt#	Interrupt source
IRQ0	Interval timer
IRQ1	Keyboard
IRQ2	Interrupt from controller 2 (cascade)
IRQ3	COM2
IRQ4	COM1
IRQ5	COM3
IRQ6	COM4
IRQ7	LPT
IRQ8	Redirected IRQ2
IRQ9	Reserved
IRQ10	Reserved
IRQ11	Reserved
IRQ12	Reserved
IRQ13	Math Coprocessor
IRQ14	Fixed Disk
IRQ15	Reserved



# Appendix **C**

GPIO & WDT Sample  
Code

## C.1 [PCM-9343 WDT]

**Note!** Index port(22h) = 13h, Data port(23h) = C5h :



Unlock function port 22h/23h for GPIO/WDT0 works.

Index port(22h) = 13h, Data port(23h) = 00h :

Lock GPIO/WDT0 function.

### 1. WDT0 GPIO Registers

Index port(22h) = 37h, Data port(23h) definition :

WDT1 control register of bit 6 is enable WDT 1 control

Index port(22h) = 38h, Data port(23h) definition :

WDT1 signal select control register of bit 7-4 set 1101b as system reset.

Index port(22h) = 39h / 3Ah / 3Bh, Data port(23h) definition :

WDT1 of counter 0~3 register, bit 7-0 resolution is 30.5us.

### 2. WDT1 GPIO Registers

IO port 68h: WDT1 control register of bit 6 is enable WDT 1 control

IO port 69h: WDT1 signal select control register of bit 7-4 set 1101b as system reset.

IO port 6Ah/6Bh / 6Ch: WDT1 of counter 0~3 register, bit 7-0 resolution is 30.5us.

### Sample code:

```
.model small
.286p
.stack
.data
.code
main:
    xor al,al    ;clear al value
    out 68h,al
    mov al,0D0h ;Issue system reset
    out 69h,al
    mov al,00h  ;count 0
    out 6ah,al
    mov al,00h  ;count 1
    out 6bh,al
    mov al,03h  ;count 2
    out 6ch,al
    mov al,040h ;enabled WDT function
    out 68h,al
    mov ah,4ch
    int 21
```

end

It will reboot after 5 seconds.

## C.2 [PCM-9343 GPIO]

### 1. GPIO Registers

IO port 98h: GPIO 0 Direction register (0 = Input / 1= Output).

IO port 99h: GPIO 1 Direction register (0 = Input / 1= Output).

IO port 78h: GPIO data port 0 base address (0 = Low / 1 = High).

IO port 79h: GPIO data port 1 base address (0 = Low / 1 = High).

### 2. Sample Code

```
.model small
.286p
.stack
.data
.code
main:
    mov dx, 98h ;GPIO 0 Direction port
    mov al, 0FFh ;Set GPIO 0 of 0 ~ 7 as output type.
    out dx, al
    inc dx ;Set 99h GPIO 1 Direction port
    out dx, al ;Set GPIO 1 of 0 ~ 7 as output type.
    mov dx, 78h ;GPIO data port 0 base address
    mov al, 55h ;Set GPIO 0 of GPIO 0, 2, 4, 6 as high, 1, 3, 5, 7 as low.
    out dx, al
    inc dx ;Set GPIO data port 1 base address

    mov al, 0AAh ;Set GPIO 1 of GPIO 1, 3, 5, 7 as high, 0, 2, 4, 6 as low.
    out dx, al

    mov ah,4ch
    int 21
end
```

*Trusted ePlatform Services*

**ADVANTECH**

**[www.advantech.com](http://www.advantech.com)**

Please verify specifications before quoting. This guide is intended for reference purposes only.

All product specifications are subject to change without notice.

No part of this publication may be reproduced in any form or by any means, electronic, photocopying, recording or otherwise, without prior written permission of the publisher.

All brand and product names are trademarks or registered trademarks of their respective companies.

© Advantech Co., Ltd. 2010