

## **EKI-7657C**

**7+3G port Industrial Managed  
Redundant Gigabit Ethernet  
Switch**

**User Manual**

## **Copyright**

The documentation and the software included with this product are copyrighted 2007 by Advantech Co., Ltd. All rights are reserved. Advantech Co., Ltd. reserves the right to make improvements in the products described in this manual at any time without notice. No part of this manual may be reproduced, copied, translated or transmitted in any form or by any means without the prior written permission of Advantech Co., Ltd. Information provided in this manual is intended to be accurate and reliable. However, Advantech Co., Ltd. assumes no responsibility for its use, nor for any infringements of the rights of third parties, which may result from its use.

## **Acknowledgements**

Intel and Pentium are trademarks of Intel Corporation.  
Microsoft Windows and MS-DOS are registered trademarks of Microsoft Corp.  
All other product names or trademarks are properties of their respective owners.

## **Product Warranty (2 years)**

Advantech warrants to you, the original purchaser, that each of its products will be free from defects in materials and workmanship for two years from the date of purchase.

This warranty does not apply to any products which have been repaired or altered by persons other than repair personnel authorized by Advantech, or which have been subject to misuse, abuse, accident or improper installation. Advantech assumes no liability under the terms of this warranty as a consequence of such events.

Because of Advantech's high quality-control standards and rigorous testing, most of our customers never need to use our repair service. If an Advantech product is defective, it will be repaired or replaced at no charge during the warranty period. For out-of-warranty repairs, you will be billed according to the cost of replacement materials, service time and freight. Please consult your dealer for more details.

If you think you have a defective product, follow these steps:

1. Collect all the information about the problem encountered. (For example, CPU speed, Advantech products used, other hardware and software used, etc.) Note anything abnormal and list any onscreen messages you get when the problem occurs.
2. Call your dealer and describe the problem. Please have your manual, product, and any helpful information readily available.
3. If your product is diagnosed as defective, obtain an RMA (return merchandise authorization) number from your dealer. This allows us to process your return more quickly.
4. Carefully pack the defective product, a fully-completed Repair and Replacement Order Card and a photocopy proof of purchase date (such as your sales receipt) in a shippable container. A product returned without proof of the purchase date is not eligible for warranty service.
5. Write the RMA number visibly on the outside of the package and ship it prepaid to your dealer.

## **Declaration of Conformity**

### **CE**

This product has passed the CE test for environmental specifications. Test conditions for passing included the equipment being operated within an industrial enclosure. In order to protect the product from being damaged by ESD (Electrostatic Discharge) and EMI leakage, we strongly recommend the use of CE-compliant industrial enclosure products.

### **FCC Class A**

This equipment has been tested and found to comply with the limits for a Class A digital device, pursuant to Part 15 of the FCC Rules. These limits are designed to provide reasonable protection against harmful interference when the equipment is operated in a commercial environment. This equipment generates, uses and can radiate radio frequency energy and, if not installed and used in accordance with the instruction manual, may cause harmful interference to radio communications. Operation of this equipment in a residential area is likely to cause harmful interference in which case the user will be required to correct the interference at his own expense.

## **Technical Support and Assistance**

- Step 1. Visit the Advantech web site at [www.advantech.com/support](http://www.advantech.com/support) where you can find the latest information about the product.
  
- Step 2. Contact your distributor, sales representative, or Advantech's customer service center for technical support if you need additional assistance. Please have the following information ready before you call:
  - Product name and serial number
  - Description of your peripheral attachments
  - Description of your software (operating system, version, application software, etc.)
  - A complete description of the problem
  - The exact wording of any error messages

## Safety Instructions

1. Read these safety instructions carefully.
2. Keep this User's Manual for later reference.
3. Disconnect this equipment from any AC outlet before cleaning. Use a damp cloth. Do not use liquid or spray detergents for cleaning.
4. For plug-in equipment, the power outlet socket must be located near the equipment and must be easily accessible.
5. Keep this equipment away from humidity.
6. Put this equipment on a reliable surface during installation. Dropping it or letting it fall may cause damage.
7. The openings on the enclosure are for air convection. Protect the equipment from overheating. **DO NOT COVER THE OPENINGS.**
8. Make sure the voltage of the power source is correct before connecting the equipment to the power outlet.
9. Position the power cord so that people cannot step on it. Do not place anything over the power cord.
10. All cautions and warnings on the equipment should be noted.
11. If the equipment is not used for a long time, disconnect it from the power source to avoid damage by transient overvoltage.
12. Never pour any liquid into an opening. This may cause fire or electrical shock.
13. Never open the equipment. For safety reasons, the equipment should be opened only by qualified service personnel.
14. If one of the following situations arises, get the equipment checked by service personnel:
  - a. The power cord or plug is damaged.
  - b. Liquid has penetrated into the equipment.
  - c. The equipment has been exposed to moisture.
  - d. The equipment does not work well, or you cannot get it to work according to the user's manual.
  - e. The equipment has been dropped and damaged.
  - f. The equipment has obvious signs of breakage.
15. **DO NOT LEAVE THIS EQUIPMENT IN AN ENVIRONMENT WHERE THE STORAGE TEMPERATURE MAY GO BELOW -40 (-40 ) OR ABOVE 85 (185 ). THIS COULD DAMAGE THE EQUIPMENT. THE EQUIPMENT SHOULD BE IN A CONTROLLED ENVIRONMENT.**

## **Safety Precaution - Static Electricity**

Follow these simple precautions to protect yourself from harm and the products from damage.

1. To avoid electrical shock, always disconnect the power from your PC chassis before you work on it. Don't touch any components on the CPU card or other cards while the PC is on.
2. Disconnect power before making any configuration changes. The sudden rush of power as you connect a jumper or install a card may damage sensitive electronic components.

# Contents

<b>Chapter 1</b>	<b>Overview</b>	<b>2</b>
1.1	Introduction	2
1.1.1	The SFP Advantage	2
1.1.2	High-Speed Transmissions	2
1.1.3	Dual Power Input	2
1.1.4	DIDO	2
1.1.5	Flexible Mounting	3
1.1.6	Advanced Protection	3
1.1.7	Wide Operating Temperature	3
1.1.8	Easy Troubleshooting	3
1.2	Features	4
1.3	Specification	5
1.4	Packing List	7
1.5	Safety Precaution	7
<b>Chapter 2</b>	<b>Installation</b>	<b>10</b>
2.1	LED Indicators	10
	Table 2.1: EKI-7657C LED Definition	10
2.2	Dimensions (units: mm)	11
	Figure 2.1: Front View of EKI-7657C	11
	Figure 2.2: Side View of EKI-7657C	12
	Figure 2.3: Rear View of EKI-7657C	13
	Figure 2.4: Top View of EKI-7657C	14
2.3	Mounting	15
2.3.1	Wall mounting	15
	Figure 2.5: Combine the Metal Mounting Kit (units: mm)	15
2.3.2	DIN-rail Mounting	16
	Figure 2.6: Installation to DIN-rail Step 1	16
	Figure 2.7: Installation to DIN-rail Step 2	17
2.4	Network Connection	18
2.5	Connection to a Fiber Optic Network	18
	Figure 2.8: Transceiver to the SFP module	18
	Figure 2.9: Transceiver Inserted	19
	Figure 2.10: LC connector to the transceiver	19
	Figure 2.11: Remove LC connector	20
	Figure 2.12: Pull out from the transceiver	20
2.6	Power Connection	21
	Figure 2.13: Pin Assignment of the Power Connector	21
2.7	Wiring the Digital Inputs/Outputs	22
	Figure 2.14: Pin Assignment of the DIDO Connector	22
<b>Chapter 3</b>	<b>Configuration</b>	<b>25</b>
3.1	RS-232 Console	25
	Figure 3.1: Open Hyper Terminal	25

Figure 3.2: COM Port Properties Setting .....	26
Figure 3.3: Login Screen: RS-232 Configuration .....	26
Figure 3.4: Command Line Interface .....	27
<b>3.1.1 Commands Level.....</b>	<b>27</b>
Table 3.1: Command Level .....	27
<b>3.1.2 Commands Set List .....</b>	<b>28</b>
Table 3.2: Commands Set List .....	28
<b>3.1.3 System Commands Set.....</b>	<b>28</b>
Table 3.3: System Commands Set.....	28
<b>3.1.4 Port Commands Set .....</b>	<b>29</b>
Table 3.4: Port Commands Set.....	29
<b>3.1.5 Trunk Commands Set.....</b>	<b>30</b>
Table 3.5: Trunk Commands Set.....	30
<b>3.1.6 VLAN Commands Set .....</b>	<b>31</b>
Table 3.6: VLAN Commands Set.....	31
<b>3.1.7 Spanning Tree Commands Set .....</b>	<b>32</b>
Table 3.7: Spanning Tree Commands Set .....	32
<b>3.1.8 QOS Commands Set.....</b>	<b>33</b>
Table 3.8: QOS Commands Set.....	33
<b>3.1.9 IGMP Commands Set.....</b>	<b>33</b>
Table 3.9: QOS Commands Set.....	33
<b>3.1.10 Mac/Filter Table Commands Set.....</b>	<b>33</b>
Table 3.10: Mac/Filter Table Commands Set.....	34
<b>3.1.11 SNMP Commands Set .....</b>	<b>34</b>
Table 3.11: SNMP Commands Set.....	34
<b>3.1.12 Port Mirroring Commands Set.....</b>	<b>35</b>
Table 3.12: Port Mirroring Commands Set .....	35
<b>3.1.13 802.1x Commands Set.....</b>	<b>35</b>
Table 3.13: 802.1x Commands Set.....	35
<b>3.1.14 TFTP Commands Set.....</b>	<b>36</b>
Table 3.14: TFTP Commands Set .....	36
<b>3.1.15 SystemLog, SMTP and Event .....</b>	<b>36</b>
Table 3.15: SysLog,SMTP,Event Commands Set.....	36
<b>3.1.16 SNTP Commands Set .....</b>	<b>37</b>
Table 3.16: SNTP Commands Set.....	37
<b>3.1.17 X-ring Commands Set.....</b>	<b>38</b>
Table 3.17: X-ring Commands Set .....	38
<b>3.2 Web Browser .....</b>	<b>39</b>
Figure 3.5: Type the address in the URL.....	39
Figure 3.6: Web Login Window .....	39
Figure 3.7: Main page.....	40
<b>3.2.1 System.....</b>	<b>41</b>
Figure 3.8: System Information.....	41
Figure 3.9: IP Configuration.....	42
Figure 3.10: DHCP Server – System Configuration ...	43
Figure 3.11: DHCP Server – Client Entries .....	44
Figure 3.12: DHCP Server – Port and IP Binding.....	44



Figure 3.13: TFTP – Update Firmware .....	45
Figure 3.14: TFTP – Restore Configuration.....	46
Figure 3.15: TFTP – Backup Configuration.....	46
Figure 3.16: Syslog Configuration .....	47
Figure 3.17: SMTP Configuration.....	48
Figure 3.18: Event Configuration.....	49
Figure 3.19: Fault Relay Alarm.....	50
Table 3.18: UTC Timezone .....	51
Figure 3.20: SNTP Configuration .....	52
Figure 3.21: IP Security .....	53
Figure 3.22: User Authentication .....	54
Figure 3.23: Digital Input/Output interface.....	56
<b>3.2.2 Port.....</b>	<b>57</b>
Figure 3.24: Port Statistics.....	57
Figure 3.25: Port Control.....	58
Figure 3.26: 2 work ports with LACP enabled.....	60
Figure 3.27: 2 work ports with LACP disabled.....	60
Figure 3.28: Static trunking group of 2 ports on single switch.....	61
Figure 3.29: Aggregator Information .....	61
Figure 3.30: State Activity.....	62
Figure 3.31: Port Mirroring .....	63
Figure 3.32: Rate Limiting .....	64
<b>3.2.3 Protocol .....</b>	<b>65</b>
Figure 3.33: VLAN Configuration .....	65
Figure 3.34: Port based mode .....	66
Figure 3.35: Port based mode-Add interface.....	67
Figure 3.36: Port Based Edit/Delete interface .....	68
Figure 3.37: 802.1Q VLAN Configuration .....	69
Figure 3.38: Edit Group Configuration interface .....	70
Figure 3.39: 802.1Q Group Configuration-Edit .....	70
Figure 3.40: RSTP System Configuration interface....	72
Figure 3.41: RSTP Port Configuration interface.....	73
Figure 3.42: SNMP System Configuration interface..	74
Figure 3.43: Trap Configuration interface.....	75
Figure 3.44: SNMP V3 Configuration interface .....	76
Figure 3.45: QoS Configuration interface .....	78
Table 3.19: IGMP types.....	80
Figure 3.46: IGMP Configuration interface .....	80
Figure 3.47: X-ring interface.....	82
Figure 3.48: LLDP Configuration interface .....	83
<b>3.2.4 Security.....</b>	<b>84</b>
Figure 3.49: 802.1x/Radius System Configuration interface .....	84
Figure 3.50: 802.1x/Radius - Port Setting interface ....	85
Figure 3.51: 802.1x/Radius - Misc Configuration interface .....	86
Figure 3.52: Static MAC Addresses interface.....	87
Figure 3.53: MAC Filtering interface.....	88
Figure 3.54: All MAC Address interface .....	88

	Figure 3.55: All MAC Address interface .....	89
	Figure 3.56: Factory Default interface .....	90
	Figure 3.57: Save Configuration interface .....	91
	Figure 3.58: System Reboot interface .....	92
<b>Chapter 4</b>	<b>Troubleshooting .....</b>	<b>94</b>
<b>Appendix A</b>	<b>Pin Assignment &amp; Wiring .....</b>	<b>96</b>
	Figure A.1: RJ-45 Pin Assignment.....	96
	Figure A.2: EIA/TIA-568B .....	96
	Figure A.3: EIA/TIA-568A .....	96
	Figure A.4: DB 9-pin female connector .....	97
<b>Appendix B</b>	<b>Compatible SFP Modules .....</b>	<b>100</b>

## Overview

Sections include:

- Introduction
- Features
- Specifications
- Packing List
- Safety Precaution

# Chapter 1 Overview

## 1.1 Introduction

---

To create reliability in your network, the EKI-7657C comes equipped with a proprietary redundant network protocol—X-Ring that was developed by Advantech, which provides users with an easy way to establish a redundant Ethernet network with ultra high-speed recovery time less than 10 ms.

Aside from 7 x 10/100Base-TX fast Ethernet ports, the EKI-7657C comes equipped with 3 combo 10/100/1000 Mbps RJ-45 copper ports or mini-GBIC expansion ports. Traditional RJ-45 ports can be used for uplinking wide-band paths in short distance (< 100 m), or the appropriate replaceable SFP module can be used for the application of wideband uploading and long distance transmissions to fit the field request flexibility. Also, the long MTBF (Mean Time Between Failures) ensures that the EKI-7657C will continue to operate until a Gigabit network infrastructure has been established, without requiring any extra upgrade costs.

### 1.1.1 The SFP Advantage

The EKI-7657C's three SFP fiber slots provide a lot of flexibility when planning and implementing a network. The slots can accept any SFP-type fiber module and these modules are designed for transmitting over distances of either 500m (multi-mode), 10km, 30km, 50km, 70km or 110km (single-mode)—and the slots support SFP modules for WDM single-fiber transmissions. This means that you can easily change the transmission mode and distance of the switch by simply pulling out the SFP module and plugging in a different module. The SFP modules are hot-swappable and plug-and-play! Also, the fact that the switch has three of these slots, means that the network manager can, for example, have one 10km module in one slot and one 110km in the other.

### 1.1.2 High-Speed Transmissions

The EKI-7657C includes a switch controller that can automatically sense transmission speeds (10/100 Mbps). The RJ-45 interface can also be auto-detected, so MDI or MDI-X is automatically selected and a crossover cable is not required. All Ethernet ports have memory buffers that support the store-and-forward mechanism. This assures that data is properly transmitted.

### 1.1.3 Dual Power Input

To reduce the risk of power failure, the EKI-7657C provides +12 ~ 48 V<sub>DC</sub> dual power inputs. If there is power failure, EKI-7657C will automatically switch to the secondary power input.

### 1.1.4 DIDO

EKI-7657C provides 2 digital inputs and 2 digital outputs. When disconnection of the specific port was detected, the digital output will activate the connected warning device to alarm the user. As for the digital inputs, they can integrate sensors into the system to issue alarms by sending Syslog, SMTP, or SNMP Trap.

### **1.1.5 Flexible Mounting**

EKI-7657C is compact and can be mounted on a DIN-rail or panel, so it is suitable for any space-constrained environment.

### **1.1.6 Advanced Protection**

The power line of EKI-7657C supports up to 3,000 V<sub>DC</sub> EFT protection, which secure equipment against unregulated voltage and make systems safer and more reliable. Meanwhile, 4,000 V<sub>DC</sub> ESD protections for Ethernet ports make EKI-7657C more suitable for harsh environments.

### **1.1.7 Wide Operating Temperature**

The operating temperature of the EKI-7657C is between -10 ~ 60 . With such a wide range, you can use the EKI-7657C in some of the harshest industrial environments that exist.

### **1.1.8 Easy Troubleshooting**

LED indicators make troubleshooting quick and easy. Each 10/100 Base-TX port has 2 LEDs that display the link status, transmission speed and collision status. Also the three power indicators P1, P2 and P-Fail help you diagnose immediately.

## 1.2 Features

---

- 3 Gigabit Copper/SFP combo ports, plus 7 Fast Ethernet ports
- SFP socket for Easy and Flexible Fiber Expansion
- Redundancy: Gigabit X-Ring (ultra high-speed recovery time<10ms), RSTP/STP (802.1w/1D)
- Management: Web, Telnet, Serial Console, Windows Utility and SNMP
- Control: VLAN/GVRP, QOS, IGMP Snooping, LACP, and Rate Limit
- Security: IP/MAC and port binding, DHCP Server, IP access list, 802.1x, SNMPv3
- Diagnostic: Port Statistic, Port Mirroring, RMON, Trap, SNMP Alert, and Syslog
- Dual 12 ~ 48 V<sub>DC</sub> power input and 1 Relay Output
- Robust mechanism and special heat spreader design
- Supports DIDO function (2 digital inputs/2 digital outputs)

## 1.3 Specification

---

### Communications

<b>Standard</b>	IEEE 802.3, 802.3ab, 802.3ad, 802.3u, 802.3x, 802.3z IEEE 802.1ab, 802.1D, 802.1w, 802.1p, 802.1Q, 802.1X
<b>LAN</b>	10/100/1000Base-TX, Optional 100Base-FX, 1000Base-SX/LX/LHX/XD/ZX/EZX
<b>Transmission Distance</b>	Ethernet: Up to 100m (4-wire Cat.5e, Cat.6 RJ-45 cable suggested for Gigabit port) SFP: Up to 110km (depends on SFP type)
<b>Transmission Speed</b>	Ethernet: 10/100Mbps, Auto-Negotiation Gigabit Copper: Up to 1000 Mbps Gigabit Fiber: Up to 1000Mbps

### Interface

<b>Connectors</b>	7 x RJ-45 (Ethernet) 3 x RJ-45/SFP (mini-GBIC) combo ports 1 x 6-pin removable terminal (power & Relay) 1 x 6-pin removable terminal (DIDO)
<b>LED Indicators</b>	System: PWR, PWR1, PWR2, R.M., P-Fail 10/100TX: Link/Activity, Duplex/Collision Gigabit Copper: Link/Activity, Speed (1000Mbps) SFP: Link/Activity
<b>Console</b>	RS-232 (RJ-45)

### Power

<b>Power Consumption</b>	Max. 10 W
<b>Power Input</b>	2 x Unregulated +12 ~ 48 V <sub>DC</sub> (0.85A max.)
<b>Overload Current Protection</b>	3.5A@12V <sub>DC</sub> (Re-settable Fuse)
<b>Fault Output</b>	1 Relay Output

### Mechanism

<b>Dimensions (WxHxD)</b>	79 x 152 x 105 mm
<b>Enclosure</b>	IP30, metal shell with solid mounting kits
<b>Mounting</b>	DIN-rail, wall

### Protection

<b>ESD (Ethernet)</b>	4,000 V <sub>DC</sub>
<b>Surge (EFT for power)</b>	3,000 V <sub>DC</sub>
<b>Reverse Polarity</b>	Present

## Environment

<b>Operating Temperature</b>	-10 ~ 60°C (14 ~ 140°F)
<b>Operating Humidity</b>	5 ~ 95% (non-condensing)
<b>Storage Temperature</b>	-40 ~ 85°C (-40 ~ 185°F)
<b>Storage Humidity</b>	0 ~ 95% (non-condensing)
<b>MTBF</b>	260,818 hours

## Certifications

<b>Safety</b>	UL, 60950-1, CAN/CSA-C22.2 No.60950
<b>EMC</b>	EU: EN55011, EN61000-6-4 EN55022, Class A, EN61000-3-2/3 EN55024 IEC61000-4-2/3/4/5/6/8 EN61000-6-2
<b>Freefall</b>	IEC60068-2-32
<b>Shock</b>	IEC60068-2-27
<b>Vibration</b>	IEC60068-2-6



## 1.4 Packing List

---

- 1 x EKI-7657C Industrial Managed Gigabit Ethernet Switch
- 1 x eAutomation Industrial Communication CD-ROM with software, and User manual
- 2 x Wall Mounting Bracket and Screws
- 1 x DIN-rail Mounting Bracket and Screws
- 1 x 8-pin RJ-45 to RS-232 serial cable
- 1 x DC Jack Cable 2.0/150mm
- 1 x EKI-7657C Startup Manual

## 1.5 Safety Precaution

---

*Attention*    *IF DC voltage is supplied by an external circuit, please use a protection device on the power supply input.*



## **Installation**

Sections include:

- LED Indicators
- Dimensions
- Mounting
- Network Connection
- Connection to a Fiber Optic Network
- Power Connection

## Chapter 2 Installation

In this chapter, you will be given an overview of the EKI-7657C hardware installation procedures.

### 2.1 LED Indicators

There are few LEDs display the power status and network status located on the front panel of EKI-7657C, each of them has its own specific meaning shown as below.

<i>Table 2.1: EKI-7657C LED Definition</i>			
LED	Color	Description	
PWR	Green	On	System power on
		Off	No power input
R.M.	Green	On	The industrial switch is the master of the X-ring group
		Off	The industrial switch is not the master of the X-ring group
PWR1	Green	On	Power input 1 is active
		Off	Power input 1 is inactive
PWR2	Green	On	Power input 2 is active
		Off	Power input 2 is inactive
P-Fail	Red	On	Power input 1 or 2 is inactive or port link down (depends on Fault Relay Alarm configuration)
		Off	Power input 1 and 2 are both active, or no power input
Link/Active (G7, G9, G10 SFP)	Green	On	SFP port is linking
		Flashing	Data is transmitting or receiving
		Off	Not connected to network
G7, G9, G10 (RJ-45)	Green (Upper LED)	On	The port is operating at speed of 1000M
		Off	The port is disconnected or not operating at speed of 1000M
	Green (Lower LED)	On	Connected to network
		Flashing	Networking is active
		Off	Not connected to network
Link/Active (1 ~ 6 & 8)	Green	On	Connected to network
		Flashing	Networking is active
		Off	Not connected to network
Duplex/Collision (1 ~ 6 & 8)	Orange	On	Ethernet port full duplex
		Flashing	Collision of packets occurs
		Off	Ethernet port half duplex or not connected to network

## 2.2 Dimensions (units: mm)

---

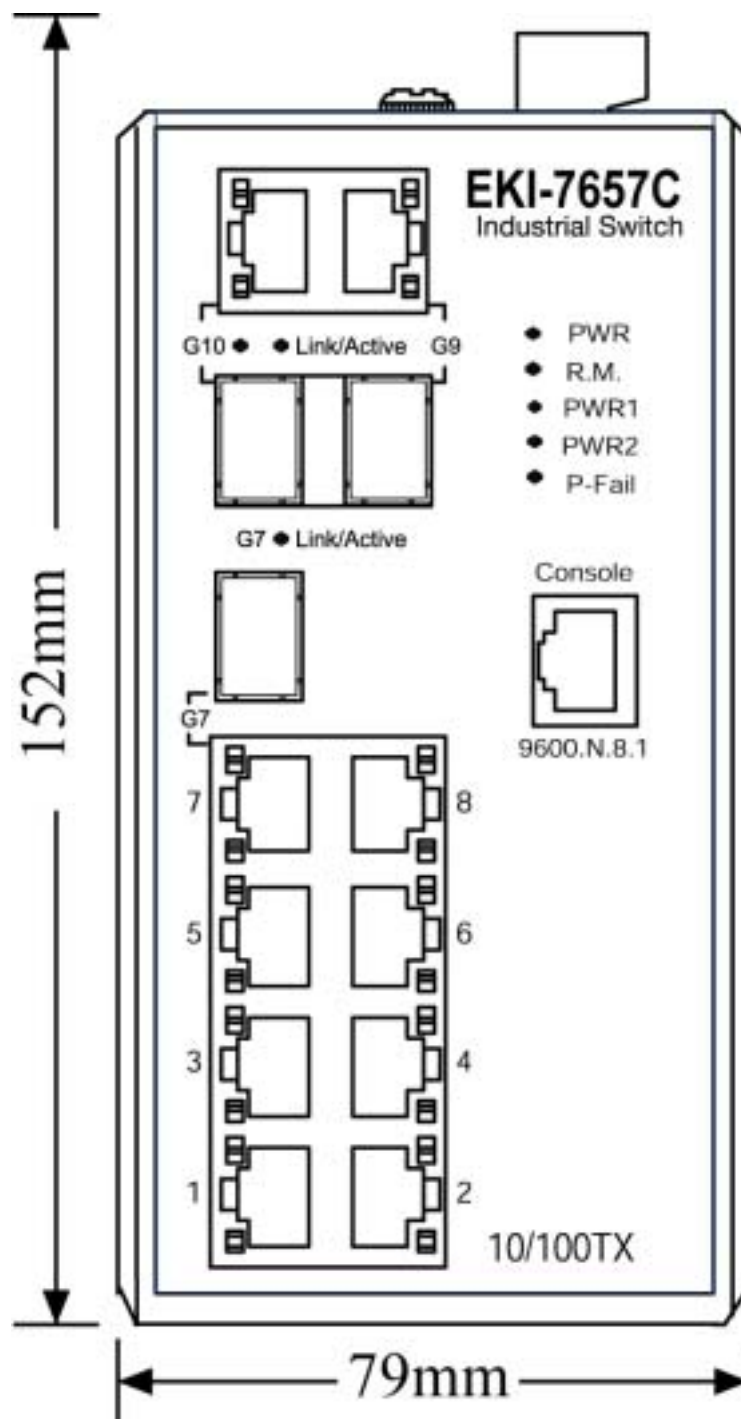

Figure 2.1: Front View of EKI-7657C

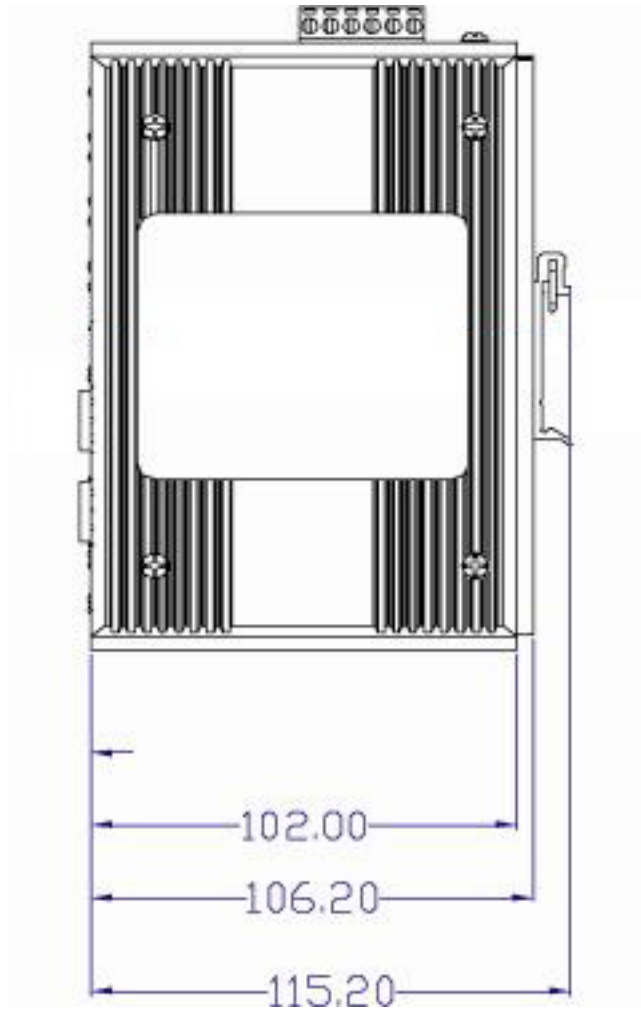

Figure 2.2: Side View of EKI-7657C

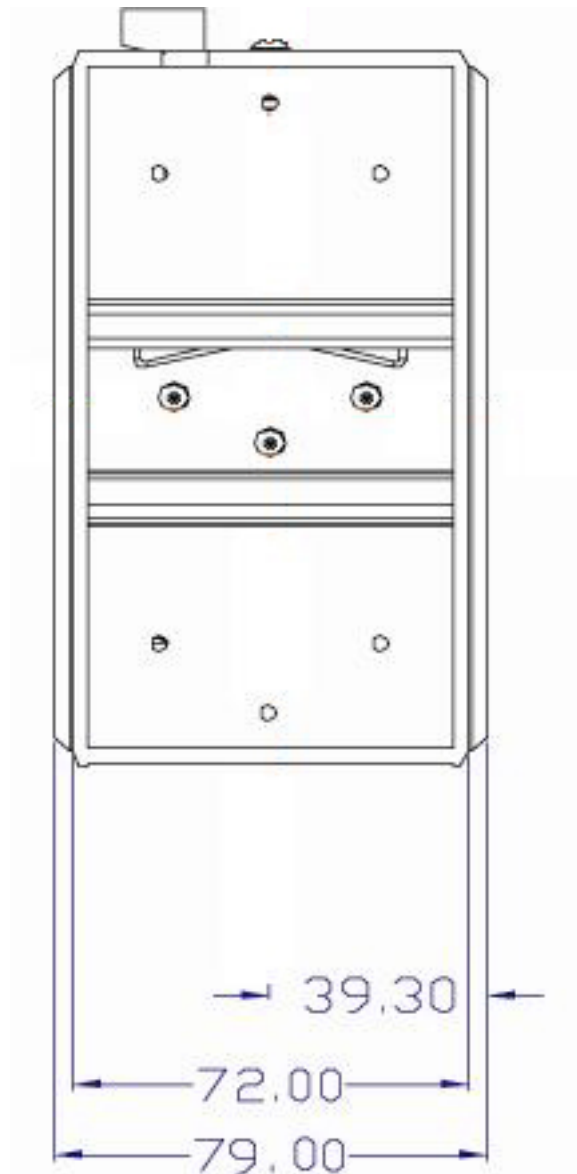

Figure 2.3: Rear View of EKI-7657C

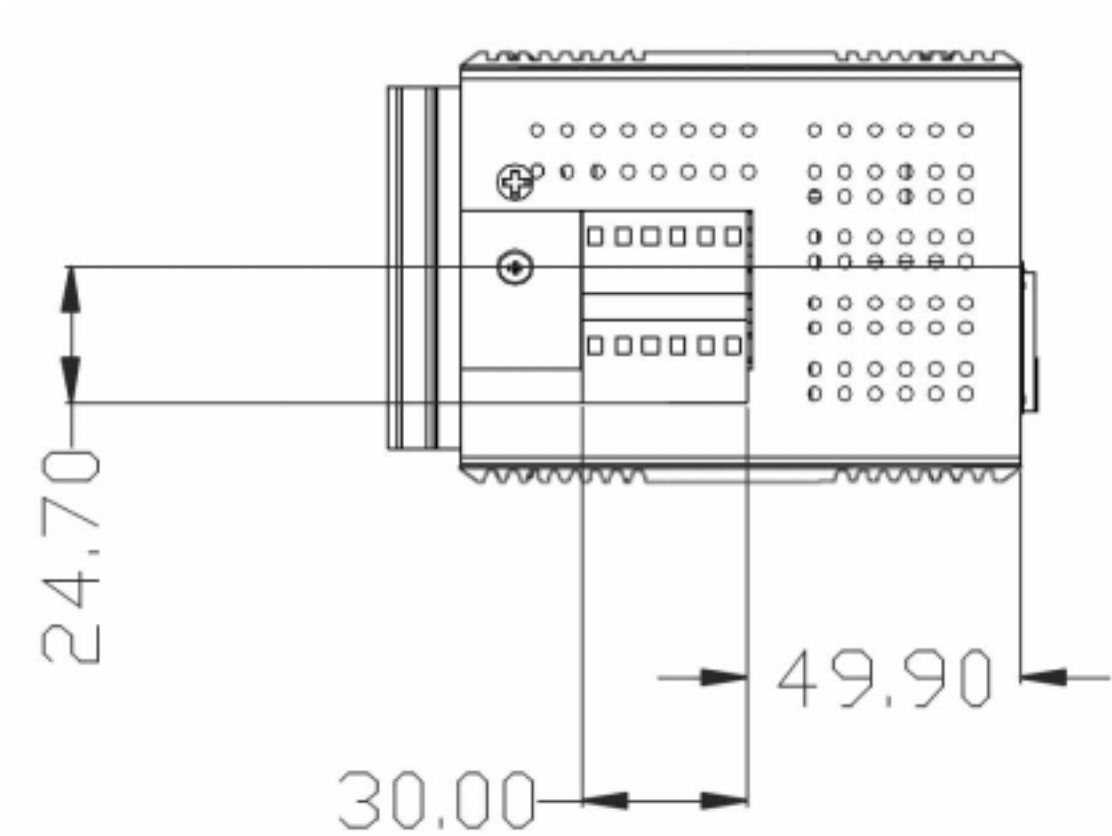

Figure 2.4: Top View of EKI-7657C



## 2.3 Mounting

The EKI-7657C supports two mounting methods: DIN-rail & Wall.

### 2.3.1 Wall mounting

EKI-7657C can be wall-mounted by using the included mounting kit. Then, hang on the EKI-7657C to the nails on the wall.

First, use the screws included in the package to combine the EKI-7657C and metal mounting kit. And then you can install the device firmly via the components, please see Figure 2.5 as below.



Figure 2.5: Combine the Metal Mounting Kit (units: mm)

### 2.3.2 DIN-rail Mounting

You can also mount EKI-7657C on a standard DIN-rail by steps below.

The DIN-rail kit is screwed on the industrial switch when out of factory. If the DIN-rail kit is not screwed on the industrial switch, please screw the DIN-rail kit on the switch first.

First, hang the EKI-7657C to the DIN-rail with angle of inclination. See Figure 2.6.



*Figure 2.6: Installation to DIN-rail Step 1*

Then, let the device down straight to slide over the rail smoothly. See Figure 2.7.



*Figure 2.7: Installation to DIN-rail Step 2*

## 2.4 Network Connection

---

The EKI-7657C has 7 x RJ-45 ports that support connection to 10 Mbps Ethernet, or 100 Mbps Fast Ethernet, and half or full duplex operation. EKI-7657C can be connected to other hubs or switches via a twisted-pair straight-through or crossover cable up to 100m long. The connection can be made from any TX port of the EKI-7657C (MDI-X) to another hub or switch either MDI-X or uplink MDI port.

The EKI-7657C supports auto-crossover to make networking more easy and flexible. You can connect any RJ-45 (MDI-X) station port on the switch to any device such as a switch, bridge or router.

## 2.5 Connection to a Fiber Optic Network

---

EKI-7657C has three SFP slots for connecting to the network segment with single or multi-mode fiber. You can choose appropriate SFP transceiver to plug into the slot. Make sure the transceiver is aligned correctly and then slide the transceiver into the SFP slot until a click is heard. You can use proper multi-mode or single-mode fiber according to the used SFP transceiver. With fiber optic, it transmits speed up to 1000 Mbps and you can prevent noise interference from the system and transmission distance up to 110 km, depending on the SFP transceiver.

The small form-factor pluggable (SFP) is a compact optical transceiver used in optical communications for both telecommunication and data communications applications.

**Note** *The SFP/Copper Combo port can't be both used at the same time. The SFP port has the higher priority than the copper port; if you insert the 1000M SFP transceiver (which is being connected to the remote device) into the SFP port, the connection of the accompanying copper port will link down. If you insert the 100M SFP transceiver into the SFP port even without a fiber connection to the remote, the connection of the accompanying copper port will link down immediately.*

To connect the transceiver and LC cable, please follow the steps shown below:

First, insert the transceiver into the SFP module. Notice that the triangle mark is the bottom of the module.

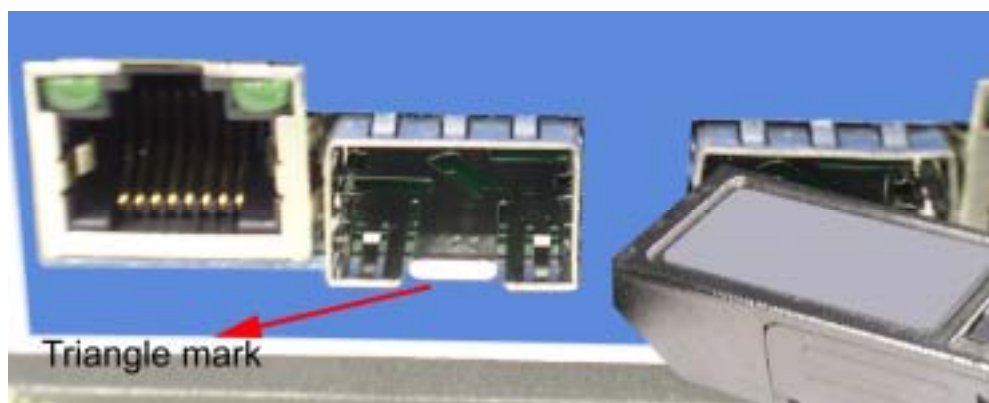
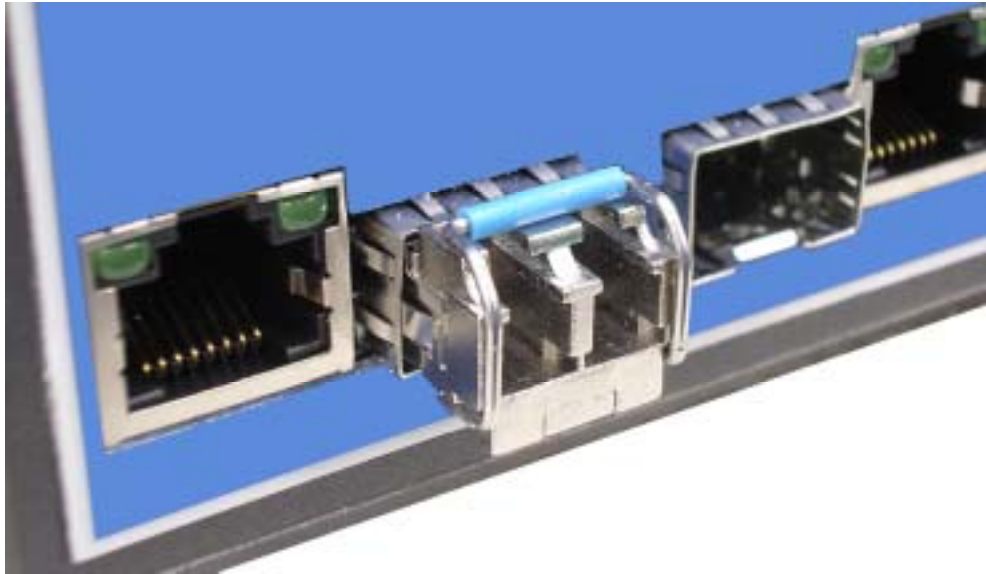

Figure 2.8: Transceiver to the SFP module



*Figure 2.9: Transceiver Inserted*

Second, insert the fiber cable of LC connector into the transceiver.



*Figure 2.10: LC connector to the transceiver*

To remove the LC connector from the transceiver, please follow the steps shown below:

First, press the upper side of the LC connector to release from the transceiver and pull it out.

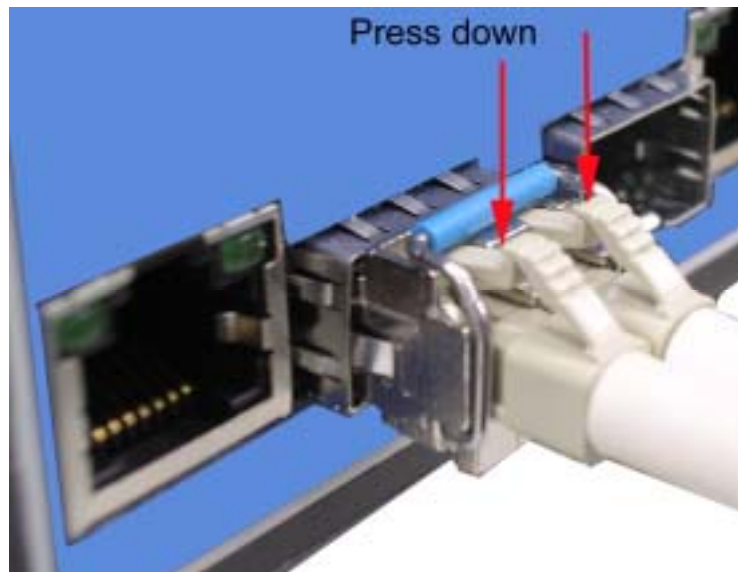

*Figure 2.11: Remove LC connector*

Second, push down the metal loop and pull the transceiver out by the plastic handle.

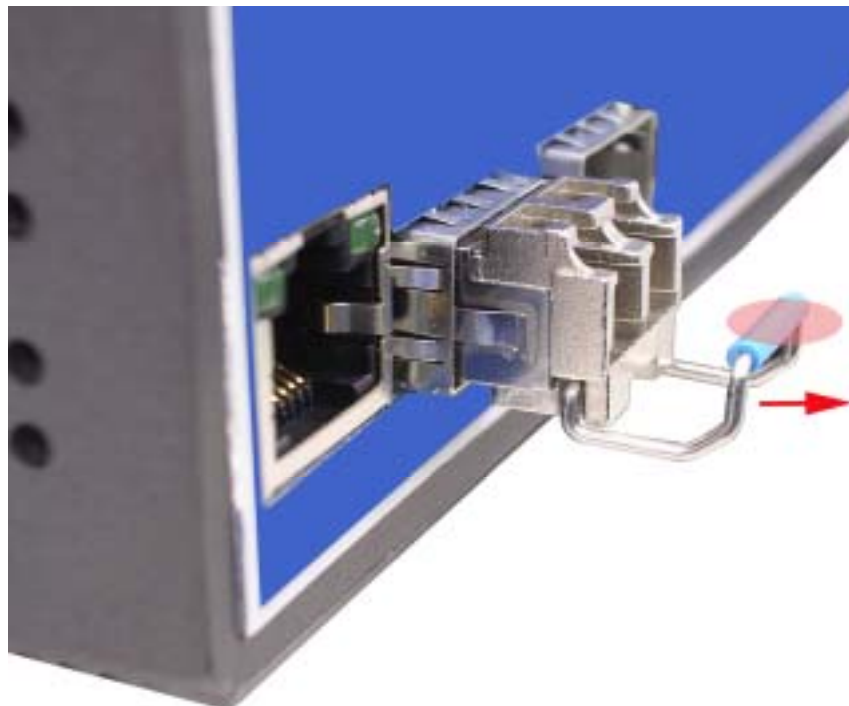
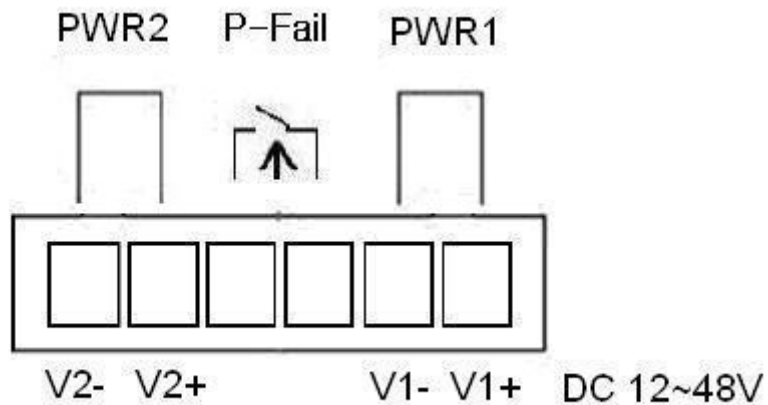

*Figure 2.12: Pull out from the transceiver*

## 2.6 Power Connection

---

The EKI-7657C supports dual +12 ~ 48 V<sub>DC</sub> power inputs and power-fail relay output.



*Figure 2.13: Pin Assignment of the Power Connector*

You can connect an alarm indicator, buzzer or other signaling equipment through the relay output. The relay opens if power input 1, 2 fails or port link down/break ("Open" means if you connect relay output with an LED, the light would be off).

## 2.7 Wiring the Digital Inputs/Outputs

EKI-7657C is equipped with two sets of digital input/output contacts of the terminal block connector. Connect the wires to DI0, DI1, DO0, DO1, and GND respectively. GND is the common ground for DI0, DI1, DO0, and DO1. **Don't connect DO0/DO1 to the external device using power higher than 40V/200mA.**

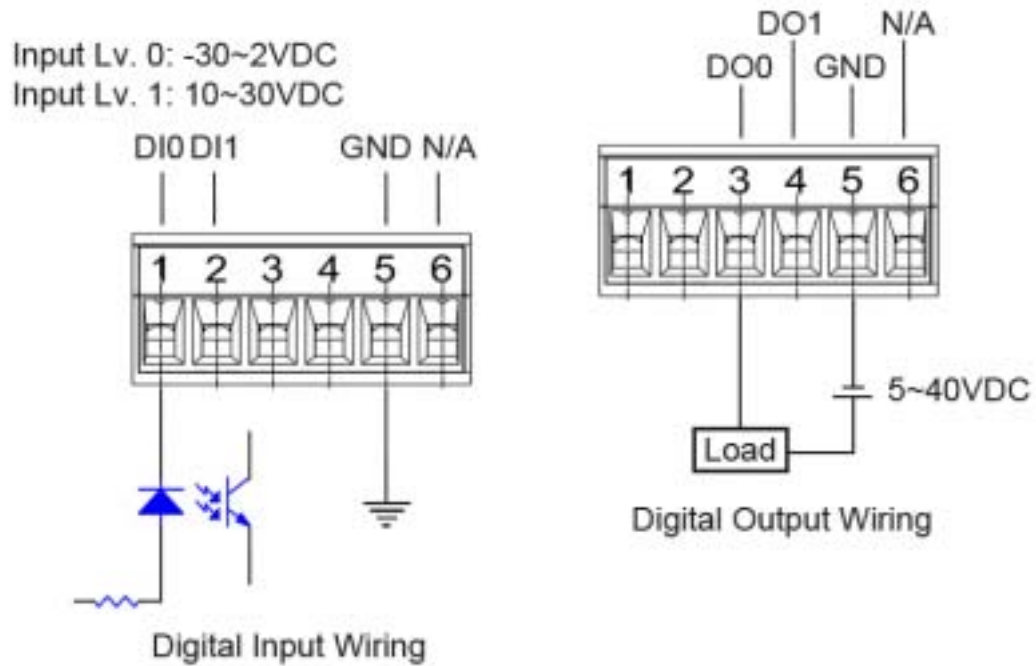

Figure 2.14: Pin Assignment of the DIDO Connector





# Configuration

Sections include:

- RS-232 Console
- Web Browser
- Mounting
- Self Diagnosis

## Chapter 3 Configuration

The EKI-7657C can be configured in two ways: via RS-232 Console or a web browser.

### 3.1 RS-232 Console

EKI-7657C's RS-232 console is designed for rapidly configuring which provides the console management—CLI command.

Attach the supplied cable, which one end is RJ-45 and the other end is female DB9, to connect EKI-7657C and your host PC or terminal. The connected PC or terminal must support the terminal emulation program.

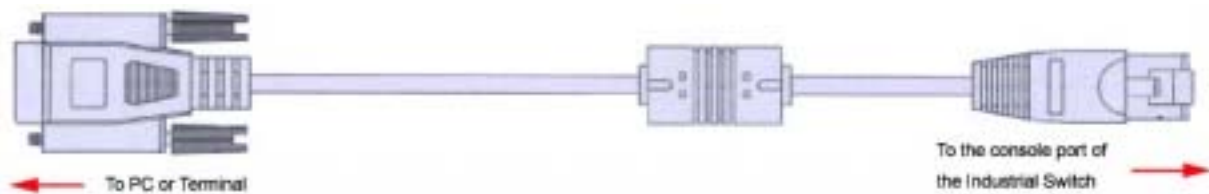

From the Windows desktop, click **Start/Programs/Accessories/Communications/HyperTerminal** to open Hyper Terminal program.

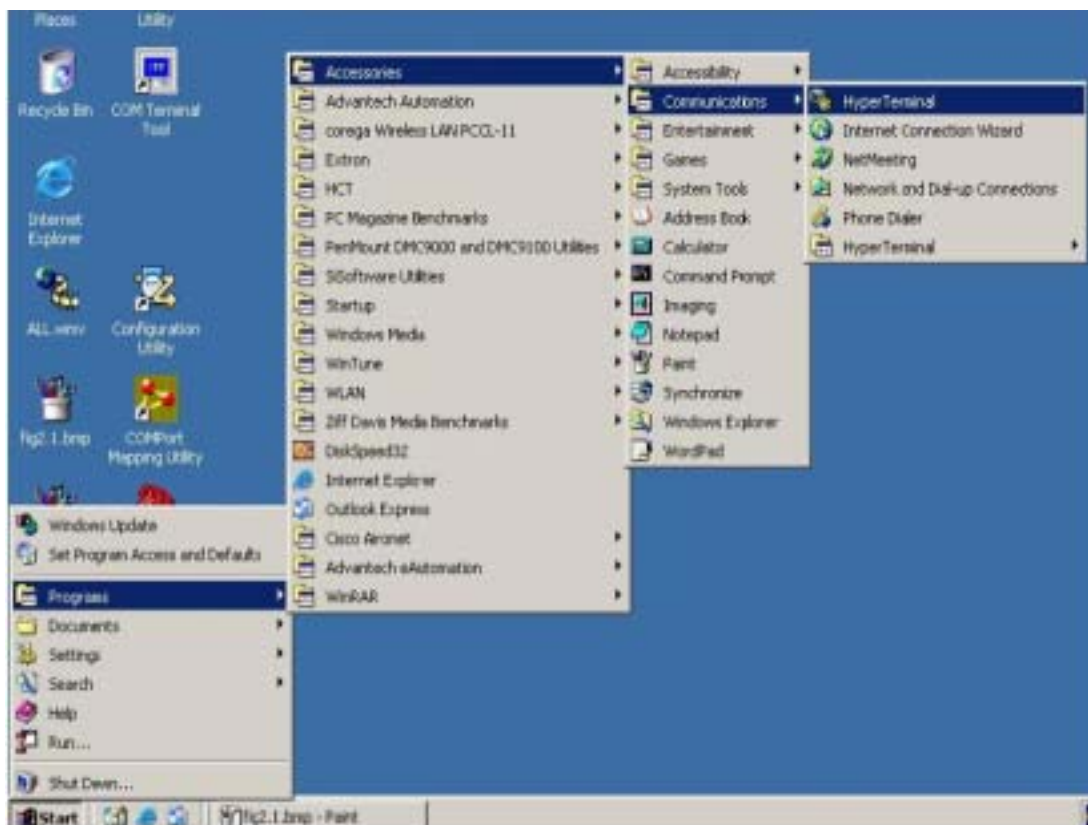

Figure 3.1: Open Hyper Terminal

Select the appropriate COM port, and set the parameter as Fig.3.2 (**9600** for **Baud Rate**, **8** for **Data Bits**, **None** for **Parity**, **1** for **Stop Bits**, and **None** for **Flow Control**).



Figure 3.2: COM Port Properties Setting

Press **Enter** for login screen (If you can not find the login screen, press **Enter** one more time). The default user name and password are both "**admin**". Key-in the user name and password to enter the command line interface.

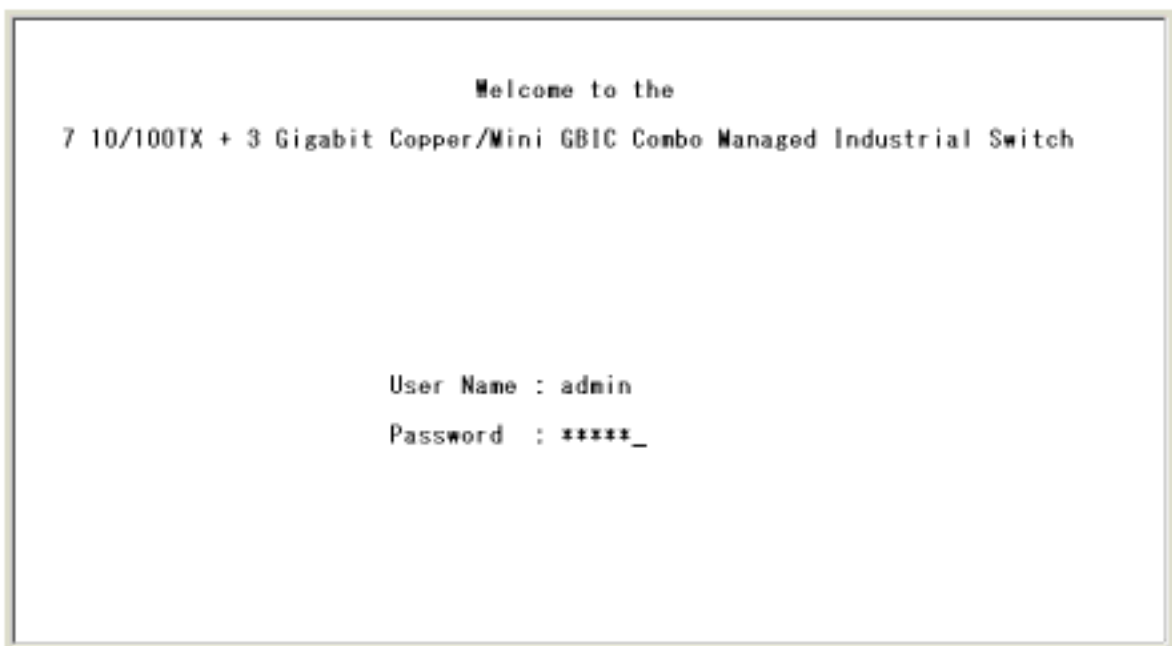

Figure 3.3: Login Screen: RS-232 Configuration

After you have logged in to the system, you will see a command prompt. To enter CLI management interface, type in the “enable” command.

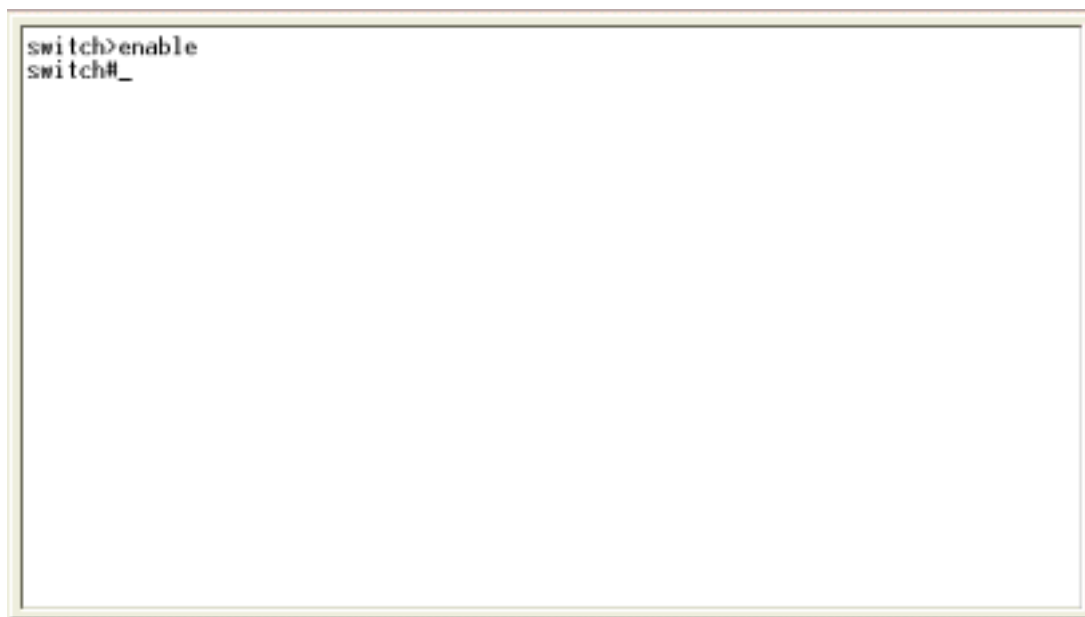

Figure 3.4: Command Line Interface

The following table lists the CLI commands and description.

### 3.1.1 Commands Level

*Table 3.1: Command Level*

Modes	Access Method	Prompt	Exit Method	About This Model
User EXEC	Begin a session with your switch.	switch>	Enter <b>logout</b> or <b>quit</b> .	The user commands available at the user level are a subset of those available at the privileged level. Use this mode to <ul style="list-style-type: none"> <li>• Perform basic tests.</li> <li>• Display system information.</li> </ul>
Privileged EXEC	Enter the <b>enable</b> command while in user EXEC mode.	switch#	Enter <b>disable</b> to exit.	The privileged command is the advanced mode Use this mode to <ul style="list-style-type: none"> <li>• Display advanced function status</li> <li>• Save configuration</li> </ul>
Global configuration	Enter the <b>configure</b> command while in privileged EXEC mode.	switch(config)#	To exit to privileged EXEC mode, enter <b>exit</b> or <b>end</b>	Use this mode to configure the parameters that are going to be applied to your switch
VLAN database	Enter the <b>vlan database</b> command while in privileged EXEC mode.	switch(vlan)#	To exit to user EXEC mode, enter <b>exit</b> .	Use this mode to configure VLAN-specific parameters.
Interface configuration	Enter the <b>interface</b> command (with a specific interface) while in global configuration mode	switch(config-if)#	To exit to global configuration mode, enter <b>exit</b> . To exist to privileged EXEC mode, enter <b>exit</b> or <b>end</b> .	Use this mode to configure the parameters for the switch and Ethernet ports.

### 3.1.2 Commands Set List

Command	Code Word
User EXEC	E
Privileged EXEC	P
Global configuration	G
VLAN database	V
Interface configuration	I

### 3.1.3 System Commands Set

Netstar Commands	Level	Description	Example
<a href="#">show config</a>	E	Show switch configuration	switch> <b>show config</b>
<a href="#">show terminal</a>	P	Show console information	switch# <b>show terminal</b>
<a href="#">write memory</a>	P	Save user configuration into permanent memory (flash rom)	switch# <b>write memory</b>
<a href="#">system name</a> [System Name]	G	Configure system name	switch(config)# <b>system name xxx</b>
<a href="#">system location</a> [System Location]	G	Set switch system location string	switch(config)# <b>system location xxx</b>
<a href="#">system description</a> [System Description]	G	Set switch system description string	switch(config)# <b>system description xxx</b>
<a href="#">system contact</a> [System Contact]	G	Set switch system contact window string	switch(config)# <b>system contact xxx</b>
<a href="#">show system-info</a>	E	Show system information	switch> <b>show system-info</b>
<a href="#">ip address</a> [Ip-address] [Subnet-mask] [Gateway]	G	Configure the IP address of switch	switch(config)# <b>ip address 192.168.1.1 255.255.255.0 192.168.1.254</b>
<a href="#">ip dhcp</a>	G	Enable DHCP client function of switch	switch(config)# <b>ip dhcp</b>
<a href="#">show ip</a>	P	Show IP information of switch	switch# <b>show ip</b>
<a href="#">no ip dhcp</a>	G	Disable DHCP client function of switch	switch(config)# <b>no ip dhcp</b>
<a href="#">reload</a>	G	Halt and perform a cold restart	switch(config)# <b>reload</b>
<a href="#">default</a>	G	Restore to default	switch(config)# <b>default</b>
<a href="#">admin username</a> [Username]	G	Changes a login username. (maximum 10 words)	switch(config)# <b>admin username xxxxxx</b>
<a href="#">admin password</a> [Password]	G	Specifies a password (maximum 10 words)	switch(config)# <b>admin password xxxxxx</b>
<a href="#">show admin</a>	P	Show administrator information	switch# <b>show admin</b>
<a href="#">dhcpserver enable</a>	G	Enable DHCP Server	switch(config)# <b>dhcpserver enable</b>
<a href="#">Dhcpserver disable</a>	G	Disable DHCP Server	switch(config)# <b>no dhcpserver</b>
<a href="#">dhcpserver lowip</a> [Low IP]	G	Configure low IP address for IP pool	switch(config)# <b>dhcpserver lowip 192.168.1.100</b>
<a href="#">dhcpserver highip</a> [High IP]	G	Configure high IP address for IP pool	switch(config)# <b>dhcpserver highip 192.168.1.200</b>

<b>dhcpserver subnetmask</b> [Subnet mask]	<b>G</b>	Configure subnet mask for DHCP clients	switch(config)# <b>dhcpserver subnetmask 255.255.255.0</b>
<b>dhcpserver gateway</b> [Gateway]	<b>G</b>	Configure gateway for DHCP clients	switch(config)# <b>dhcpserver gateway 192.168.1.254</b>
<b>dhcpserver dnsip</b> [DNS IP]	<b>G</b>	Configure DNS IP for DHCP clients	switch(config)# <b>dhcpserver dnsip 192.168.1.1</b>
<b>dhcpserver leasetime</b> [Hours]	<b>G</b>	Configure lease time (in hour)	switch(config)# <b>dhcpserver leasetime 1</b>
<b>dhcpserver ipbinding</b> [IP address]	<b>I</b>	Set static IP for DHCP clients by port	switch(config)# <b>interface fastEthernet 2</b> switch(config)# <b>dhcpserver ipbinding 192.168.1.1</b>
<b>show dhcpserver configuration</b>	<b>P</b>	Show configuration of DHCP server	switch# <b>show dhcpserver configuration</b>
<b>show dhcpserver clients</b>	<b>P</b>	Show client entries of DHCP server	switch# <b>show dhcpserver clients</b>
<b>show dhcpserver ip-binding</b>	<b>P</b>	Show IP-Binding information of DHCP server	switch# <b>show dhcpserver ip-binding</b>
<b>no dhcpserver</b>	<b>G</b>	Disable DHCP server function	switch(config)# <b>no dhcpserver</b>
<b>security enable</b>	<b>G</b>	Enable IP security function	switch(config)# <b>security enable</b>
<b>security http</b>	<b>G</b>	Enable IP security of HTTP server	switch(config)# <b>security http</b>
<b>security telnet</b>	<b>G</b>	Enable IP security of telnet server	switch(config)# <b>security telnet</b>
<b>security ip</b> [Index(1..10)] [IP Address]	<b>G</b>	Set the IP security list	switch(config)# <b>security ip 1 192.168.1.55</b>
<b>show security</b>	<b>P</b>	Show the information of IP security	switch# <b>show security</b>
<b>no security</b>	<b>G</b>	Disable IP security function	switch(config)# <b>no security</b>
<b>no security http</b>	<b>G</b>	Disable IP security of HTTP server	switch(config)# <b>no security http</b>
<b>no security telnet</b>	<b>G</b>	Disable IP security of telnet server	switch(config)# <b>no security telnet</b>

### 3.1.4 Port Commands Set

*Table 3.4: Port Commands Set*

Netstar Commands	Level	Description	Example
<b>interface fastEthernet</b> [Portid]	<b>G</b>	Choose the port for modification.	switch(config)# <b>interface fastEthernet 2</b>
<b>duplex</b> [full   half]	<b>I</b>	Use the duplex configuration command to specify the duplex mode of operation for Fast Ethernet.	switch(config)# <b>interface fastEthernet 2</b> switch(config-if)# <b>duplex full</b>
<b>speed</b> [10 100 1000 auto]	<b>I</b>	Use the speed configuration command to specify the speed mode of operation for Fast Ethernet., the speed can't be set to 1000 if the port isn't a giga port..	switch(config)# <b>interface fastEthernet 2</b> switch(config-if)# <b>speed 100</b>
<b>no flowcontrol</b>	<b>I</b>	Disable flow control of interface	switch(config-if)# <b>no flowcontrol</b>
<b>security enable</b>	<b>I</b>	Enable security of interface	switch(config)# <b>interface fastEthernet 2</b> switch(config-if)# <b>security enable</b>
<b>no security</b>	<b>I</b>	Disable security of interface	switch(config)# <b>interface fastEthernet 2</b> switch(config-if)# <b>no security</b>

<b>bandwidth type all</b>	I	Set interface ingress limit frame type to "accept all frame"	switch(config)#interface fastEthernet 2 switch(config-if)#bandwidth type all
<b>bandwidth type broadcast-multicast-flooded-unicast</b>	I	Set interface ingress limit frame type to "accept broadcast, multicast, and flooded unicast frame"	switch(config)#interface fastEthernet 2 switch(config-if)#bandwidth type broadcast-multicast-flooded-unicast
<b>bandwidth type broadcast-multicast</b>	I	Set interface ingress limit frame type to "accept broadcast and multicast frame"	switch(config)#interface fastEthernet 2 switch(config-if)#bandwidth type broadcast-multicast
<b>bandwidth type broadcast-only</b>	I	Set interface ingress limit frame type to "only accept broadcast frame"	switch(config)#interface fastEthernet 2 switch(config-if)#bandwidth type broadcast-only
<b>bandwidth in</b> [Value]	I	Set interface input bandwidth. Rate Range is from 100 kbps to 102400 kbps or to 256000 kbps for giga ports, and zero means no limit.	switch(config)#interface fastEthernet 2 switch(config-if)#bandwidth in 100
<b>bandwidth out</b> [Value]	I	Set interface output bandwidth. Rate Range is from 100 kbps to 102400 kbps or to 256000 kbps for giga ports, and zero means no limit.	switch(config)#interface fastEthernet 2 switch(config-if)#bandwidth out 100
<b>show bandwidth</b>	I	Show interfaces bandwidth control	switch(config)#interface fastEthernet 2 switch(config-if)#show bandwidth
<b>state</b> [Enable   Disable]	I	Use the state interface configuration command to specify the state mode of operation for Ethernet ports. Use the disable form of this command to disable the port.	switch(config)#interface fastEthernet 2 switch(config-if)#state Disable
<b>show interface configuration</b>	I	show interface configuration status	switch(config)#interface fastEthernet 2 switch(config-if)#show interface configuration
<b>show interface status</b>	I	show interface actual status	switch(config)#interface fastEthernet 2 switch(config-if)#show interface status
<b>show interface accounting</b>	I	show interface statistic counter	switch(config)#interface fastEthernet 2 switch(config-if)#show interface accounting
<b>no accounting</b>	I	Clear interface accounting information	switch(config)#interface fastEthernet 2 switch(config-if)#no accounting

### 3.1.5 Trunk Commands Set

Table 3.5: Trunk Commands Set			
Netstar Commands	Level	Description	Example
<b>aggregator priority</b> [1~65535]	G	Set port group system priority	switch(config)#aggregator priority 22
<b>aggregator activityport</b> [Group ID] [Port Numbers]	G	Set activity port	switch(config)#aggregator activityport 2
<b>aggregator group</b> [GroupID] [Port-list] <b>lACP</b> <b>workp</b> [Workport]	G	Assign a trunk group with LACP active. [GroupID] :1~3 [Port-list]:Member port list, This parameter could be a port range(ex.1-4) or a port list separate by a comma(ex.2, 3, 6) [Workport]: The amount of work ports, this value could not be less than zero or be large than the amount of member ports.	switch(config)#aggregator group 1 1-4 lACP workp 2 or switch(config)#aggregator group 2 1,4,3 lACP workp 3



<b>aggregator group</b> [GroupID] [Port-list] <b>nolacp</b>	<b>G</b>	Assign a static trunk group. [GroupID] :1~3 [Port-list]:Member port list, This parameter could be a port range(ex.1-4) or a port list separate by a comma(ex.2, 3, 6)	switch(config)# <b>aggregator group 1 2-4 nolacp</b> or switch(config)# <b>aggregator group 1 3,1,2 nolacp</b>
<b>show aggregator</b>	<b>P</b>	Show the information of trunk group	switch# <b>show aggregator 1</b> or switch# <b>show aggregator 2</b> or switch# <b>show aggregator 3</b>
<b>no aggregator lacp</b> [GroupID]	<b>G</b>	Disable the LACP function of trunk group	switch(config)# <b>no aggregator lacp 1</b>
<b>no aggregator group</b> [GroupID]	<b>G</b>	Remove a trunk group	switch(config)# <b>no aggregator group 2</b>

### 3.1.6 VLAN Commands Set

<i>Table 3.6: VLAN Commands Set</i>			
Netstar Commands	Level	Description	Example
<b>vlan database</b>	<b>P</b>	Enter VLAN configure mode	switch# <b>vlan database</b>
<b>Vlanmode</b> [portbase] 802.1q   gvrp]	<b>V</b>	To set switch VLAN mode.	switch(vlan)# <b>vlanmode portbase</b> or switch(vlan)# <b>vlanmode 802.1q</b> or switch(vlan)# <b>vlanmode gvrp</b>
<b>no vlan</b>	<b>V</b>	No VLAN	Switch(vlan)# <b>no vlan</b>
<b>Ported based VLAN configuration</b>			
<b>vlan port-based grpname</b> [Group Name] <b>grpname</b> [GroupID] <b>port</b> [PortNumbers]	<b>V</b>	Add new port based VALN	switch(vlan)# <b>vlan port-based grpname test grpname 2 port 2-4</b> or switch(vlan)# <b>vlan port-based grpname test grpname 2 port 2,3,4</b>
<b>show vlan</b> [GroupID] or <b>show vlan</b>	<b>V</b>	Show VLAN information	switch(vlan)# <b>show vlan 23</b>
<b>no vlan group</b> [GroupID]	<b>V</b>	Delete port base group ID	switch(vlan)# <b>no vlan group 2</b>
<b>IEEE 802.1Q VLAN</b>			
<b>vlan 8021q name</b> [GroupName] <b>name</b> [VID]	<b>V</b>	Change the name of VLAN group, if the group didn't exist, this command can't be applied.	switch(vlan)# <b>vlan 8021q name test vid 22</b>
<b>vlan 8021q port</b> [PortNumber] <b>access-link untag</b> [UntaggedVID]	<b>V</b>	Assign a access link for VLAN by port, if the port belong to a trunk group, this command can't be applied.	switch(vlan)# <b>vlan 8021q port 3 access-link untag 33</b>
<b>vlan 8021q port</b> [PortNumber] <b>trunk-link tag</b> [TaggedVID List]	<b>V</b>	Assign a trunk link for VLAN by port, if the port belong to a trunk group, this command can't be applied.	switch(vlan)# <b>vlan 8021q port 3 trunk-link tag 2,3,6,99</b> or switch(vlan)# <b>vlan 8021q port 3 trunk-link tag 3-20</b>
<b>vlan 8021q port</b> [PortNumber] <b>hybrid-link untag</b> [UntaggedVID] <b>tag</b> [TaggedVID List]	<b>V</b>	Assign a hybrid link for VLAN by port, if the port belong to a trunk group, this command can't be applied.	switch(vlan)# <b>vlan 8021q port 3 hybrid-link untag 4 tag 3,6,8</b> or switch(vlan)# <b>vlan 8021q port 3 hybrid-link untag 5 tag 6-8</b>

<b>vlan 8021q trunk</b> [PortNumber] <b>access-link untag</b> [UntaggedVID]	V	Assign a access link for VLAN by trunk group	switch(vlan)# <b>vlan 8021q trunk 3 access-link untag 33</b>
<b>vlan 8021q trunk</b> [PortNumber] <b>trunk-link tag</b> [TaggedVID List]	V	Assign a trunk link for VLAN by trunk group	switch(vlan)# <b>vlan 8021q trunk 3 trunk-link tag 2,3,6,99</b> or switch(vlan)# <b>vlan 8021q trunk 3 trunk-link tag 3-20</b>
<b>vlan 8021q trunk</b> [PortNumber] <b>hybrid-link untag</b> [UntaggedVID] <b>tag</b> [TaggedVID List]	V	Assign a hybrid link for VLAN by trunk group	switch(vlan)# <b>vlan 8021q trunk 3 hybrid-link untag 4 tag 3,6,8</b> or switch(vlan)# <b>vlan 8021q trunk 3 hybrid-link untag 5 tag 6-8</b>
<b>show vlan</b> [GroupID] or <b>show vlan</b>	V	Show VLAN information	switch(vlan)# <b>show vlan 23</b>
<b>no vlan group</b> [GroupID]	V	Delete port base group ID	switch(vlan)# <b>no vlan group 2</b>

### 3.1.7 Spanning Tree Commands Set

Table 3.7: Spanning Tree Commands Set			
Netstar Commands	Level	Description	Example
<b>spanning-tree enable</b>	G	Enable spanning tree	switch(config)# <b>spanning-tree enable</b>
<b>spanning-tree priority</b> [0~61440]	G	Configure spanning tree priority parameter	switch(config)# <b>spanning-tree priority 32768</b>
<b>spanning-tree max-age</b> [seconds]	G	Use the spanning-tree max-age global configuration command to change the interval between messages the spanning tree receives from the root switch. If a switch does not receive a bridge protocol data unit (BPDU) message from the root switch within this interval, it recomputed the Spanning Tree Protocol (STP) topology.	switch(config)# <b>spanning-tree max-age 15</b>
<b>spanning-tree hello-time</b> [seconds]	G	Use the spanning-tree hello-time global configuration command to specify the interval between hello bridge protocol data units (BPDUs).	switch(config)# <b>spanning-tree hello-time 3</b>
<b>spanning-tree forward-time</b> [seconds]	G	Use the spanning-tree forward-time global configuration command to set the forwarding-time for the specified spanning-tree instances. The forwarding time determines how long each of the listening and learning states last before the port begins forwarding.	switch(config)# <b>spanning-tree forward-time 20</b>
<b>stp-path-cost</b> [1~200000000]	I	Use the spanning-tree cost interface configuration command to set the path cost for Spanning Tree Protocol (STP) calculations. In the event of a loop, spanning tree considers the path cost when selecting an interface to place into the forwarding state.	switch(config)# <b>interface fastEthernet 2</b> switch(config-if)# <b>stp-path-cost 20</b>
<b>stp-path-priority</b> [Port Priority]	I	Use the spanning-tree port-priority interface configuration command to configure a port priority that is used when two switches tie for	switch(config)# <b>interface fastEthernet 2</b> switch(config-if)# <b>stp-path-priority 128</b>

		position as the root switch.	
<b>stp-admin-p2p</b> [Auto True False]	I	Admin P2P of STP priority on this interface.	switch(config)#interface fastEthernet 2 switch(config-if)#stp-admin-p2p Auto
<b>stp-admin-edge</b> [True False]	I	Admin Edge of STP priority on this interface.	switch(config)#interface fastEthernet 2 switch(config-if)#stp-admin-edge True
<b>stp-admin-non-stp</b> [True False]	I	Admin NonSTP of STP priority on this interface.	switch(config)#interface fastEthernet 2 switch(config-if)#stp-admin-non-stp False
<b>show spanning-tree</b>	E	Displays a summary of the spanning-tree states.	switch>show spanning-tree
<b>no spanning-tree</b>	G	Disable spanning-tree.	switch(config)#no spanning-tree

### 3.1.8 QOS Commands Set

*Table 3.8: QOS Commands Set*

Netstar Commands	Level	Description	Example
<b>qos policy</b> [weighted-fair strict]	G	Select QOS policy scheduling	switch(config)#qos policy weighted-fair
<b>qos prioritytype</b> [port-based cos-only tos-only cos-first tos-first]	G	Setting of QOS priority type	switch(config)#qos prioritytype
<b>qos priority portbased</b> [Port] [lowest low middle high]	G	Configure Port-based Priority	switch(config)#qos priority portbased 1 low
<b>qos priority cos</b> [Priority][lowest low middle high]	G	Configure COS Priority	switch(config)#qos priority cos 0 middle
<b>qos priority tos</b> [Priority][lowest low middle high]	G	Configure TOS Priority	switch(config)#qos priority tos 3 high
<b>show qos</b>	P	Displays the information of QoS configuration	Switch#show qos
<b>no qos</b>	G	Disable QoS function	switch(config)#no qos

### 3.1.9 IGMP Commands Set

*Table 3.9: QOS Commands Set*

Netstar Commands	Level	Description	Example
<b>igmp enable</b>	G	Enable IGMP snooping function	switch(config)#igmp enable
<b>igmp-query auto</b>	G	Set IGMP query to auto mode	switch(config)#igmp-query auto
<b>igmp-query force</b>	G	Set IGMP query to force mode	switch(config)#igmp-query force
<b>show igmp configuration</b>	P	Displays the details of an IGMP configuration.	switch#show igmp configuration
<b>show igmp multi</b>	P	Displays the details of an IGMP snooping entries.	switch#show igmp multi
<b>no igmp</b>	G	Disable IGMP snooping function	switch(config)#no igmp
<b>no igmp-query</b>	G	Disable IGMP query	switch#no igmp-query

### 3.1.10 Mac/Filter Table Commands Set

Table 3.10: Mac/Filter Table Commands Set

Netstar Commands	Level	Description	Example
<b>mac-address-table static hwaddr</b> [MAC]	I	Configure MAC address table of interface (static).	switch(config)#interface fastEthernet 2 switch(config-if)#mac-address-table static hwaddr 000012345678
<b>mac-address-table filter hwaddr</b> [MAC]	G	Configure MAC address table(filter)	switch(config)#mac-address-table filter hwaddr 000012348678
<b>show mac-address-table</b>	P	Show all MAC address table	switch#show mac-address-table
<b>show mac-address-table static</b>	P	Show static MAC address table	switch#show mac-address-table static
<b>show mac-address-table filter</b>	P	Show filter MAC address table.	switch#show mac-address-table filter
<b>no mac-address-table static hwaddr</b> [MAC]	I	Remove an entry of MAC address table of interface (static)	switch(config)#interface fastEthernet 2 switch(config-if)#no mac-address-table static hwaddr 000012345678
<b>no mac-address-table filter hwaddr</b> [MAC]	G	Remove an entry of MAC address table (filter)	switch(config)#no mac-address-table filter hwaddr 000012348678
<b>no mac-address-table</b>	G	Remove dynamic entry of MAC address table	switch(config)#no mac-address-table

### 3.1.11 SNMP Commands Set

Table 3.11: SNMP Commands Set

Netstar Commands	Level	Description	Example
<b>snmp system-name</b> [System Name]	G	Set SNMP agent system name	switch(config)#snmp system-name l2switch
<b>snmp system-location</b> [System Location]	G	Set SNMP agent system location	switch(config)#snmp system-location lab
<b>snmp system-contact</b> [System Contact]	G	Set SNMP agent system contact	switch(config)#snmp system-contact where
<b>snmp agent-mode</b> [v1v2c v3 v1v2cv3]	G	Select the agent mode of SNMP	switch(config)#snmp agent-mode v1v2cv3
<b>snmp community-strings</b> [Community] <b>right</b> [RO/RW]	G	Add SNMP community string.	switch(config)#snmp community-strings public right rw
<b>snmp-server host</b> [IP address] <b>community</b> [Community-string] <b>trap-version</b> [v1 v2c]	G	Configure SNMP server host information and community string	switch(config)#snmp-server host 192.168.1.50 community public trap-version v1 (remove) Switch(config)# no snmp-server host 192.168.1.50
<b>snmpv3 context-name</b> [Context Name ]	G	Configure the context name	switch(config)#snmpv3 context-name Test
<b>snmpv3 user</b> [User Name] <b>group</b> [Group Name] <b>password</b> [Authentication Password] [Privacy Password]	G	Configure the userprofile for SNMPV3 agent. Privacy password could be empty.	switch(config)#snmpv3 user test01 group G1 password AuthPW PrivPW
<b>snmpv3 access context-name</b> [Context Name ] <b>group</b> [Group Name ] <b>security-level</b> [NoAuthNoPriv AuthNoPriv AuthPriv] <b>match-rule</b> [Exact Prefix] <b>views</b> [Read View Name] [Write View Name] [Notify View Name]	G	Configure the access table of SNMPV3 agent	switch(config)#snmpv3 access context-name Test group G1 security-level AuthPriv match-rule Exact views V1 V1 V1
<b>snmpv3 mibview view</b> [View Name] <b>type</b> [Excluded Included]	G	Configure the mibview table of SNMPV3 agent	switch(config)#snmpv3 mibview view V1 type Excluded sub-oid 1.3.6.1

<b>sub-oid</b> [OID]			
<b>show snmp</b>	<b>P</b>	Show SNMP configuration	switch#show snmp
<b>no snmp community-strings</b> [Community]	<b>G</b>	Remove the specified community.	switch(config)#no snmp community-strings public
<b>no snmp-server host</b> [Host-address]	<b>G</b>	Remove the SNMP server host.	switch(config)#no snmp-server host 192.168.1.50
<b>no snmpv3 user</b> [User Name]	<b>G</b>	Remove specified user of SNMPv3 agent.	switch(config)#no snmpv3 user Test
<b>no snmpv3 access context-name</b> [Context Name ] <b>group</b> [Group Name ] <b>security-level</b> [NoAuthNoPriv AuthNoPriv AuthPriv] <b>match-rule</b> [Exact Prefix] <b>views</b> [Read View Name] [Write View Name] [Notify View Name]	<b>G</b>	Remove specified access table of SNMPv3 agent.	switch(config)#no snmpv3 access context-name Test group G1 security-level AuthPr iv match-rule Exact views V1 V1 V1
<b>no snmpv3 mibview view</b> [View Name] <b>type</b> [Excluded Included] <b>sub-oid</b> [OID]	<b>G</b>	Remove specified mibview table of SNMPv3 agent.	switch(config)#no snmpv3 mibview view V1 type Excluded sub-oid 1.3.6.1

### 3.1.12 Port Mirroring Commands Set

Table 3.12: Port Mirroring Commands Set			
Netstar Commands	Level	Description	Example
<b>monitor rx</b>	<b>G</b>	Set RX destination port of monitor function	switch(config)#monitor rx
<b>monitor tx</b>	<b>G</b>	Set TX destination port of monitor function	switch(config)#monitor tx
<b>show monitor</b>	<b>P</b>	Show port monitor information	switch#show monitor
<b>monitor</b> [RX TX Both]	<b>I</b>	Configure source port of monitor function	switch(config)#interface fastEthernet 2 switch(config-if)#monitor RX
<b>show monitor</b>	<b>I</b>	Show port monitor information	switch(config)#interface fastEthernet 2 switch(config-if)#show monitor
<b>no monitor</b>	<b>I</b>	Disable source port of monitor function	switch(config)#interface fastEthernet 2 switch(config-if)#no monitor

### 3.1.13 802.1x Commands Set

Table 3.13: 802.1x Commands Set			
Netstar Commands	Level	Description	Example
<b>8021x enable</b>	<b>G</b>	Use the 802.1x global configuration command to enable 802.1x protocols.	switch(config)# 8021x enable
<b>8021x system radiusip</b> [IP address]	<b>G</b>	Use the 802.1x system radius IP global configuration command to change the radius server IP.	switch(config)# 8021x system radiusip 192.168.1.1
<b>8021x system serverport</b> [port ID]	<b>G</b>	Use the 802.1x system server port global configuration command to	switch(config)# 8021x system serverport 1812

		change the radius server port	
<b>8021x system accountport</b> [port ID]	<b>G</b>	Use the 802.1x system account port global configuration command to change the accounting port	switch(config)# <b>8021x system accountport 1813</b>
<b>8021x system sharedkey</b> [ID]	<b>G</b>	Use the 802.1x system share key global configuration command to change the shared key value.	switch(config)# <b>8021x system sharedkey 123456</b>
<b>8021x system nasid</b> [words]	<b>G</b>	Use the 802.1x system nasid global configuration command to change the NAS ID	switch(config)# <b>8021x system nasid test1</b>
<b>8021x misc quietperiod</b> [sec.]	<b>G</b>	Use the 802.1x misc quiet period global configuration command to specify the quiet period value of the switch.	switch(config)# <b>8021x misc quietperiod 10</b>
<b>8021x misc txperiod</b> [sec.]	<b>G</b>	Use the 802.1x misc TX period global configuration command to set the TX period.	switch(config)# <b>8021x misc txperiod 5</b>
<b>8021x misc supptimeout</b> [sec.]	<b>G</b>	Use the 802.1x misc supp timeout global configuration command to set the supplicant timeout.	switch(config)# <b>8021x misc supptimeout 20</b>
<b>8021x misc servertimeout</b> [sec.]	<b>G</b>	Use the 802.1x misc server timeout global configuration command to set the server timeout.	switch(config)# <b>8021x misc servertimeout 20</b>
<b>8021x misc maxrequest</b> [number]	<b>G</b>	Use the 802.1x misc max request global configuration command to set the MAX requests.	switch(config)# <b>8021x misc maxrequest 3</b>
<b>8021x misc reauthperiod</b> [sec.]	<b>G</b>	Use the 802.1x misc reauth period global configuration command to set the reauth period.	switch(config)# <b>8021x misc reauthperiod 3000</b>
<b>8021x portstate</b> [disable   reject   accept   authorize]	<b>I</b>	Use the 802.1x port state interface configuration command to set the state of the selected port.	switch(config)# <b>interface fastethernet 3</b> switch(config-if)# <b>8021x portstate accept</b>
<b>show 8021x</b>	<b>E</b>	Displays a summary of the 802.1x properties and also the port states.	switch> <b>show 8021x</b>
<b>no 8021x</b>	<b>G</b>	Disable 802.1x function	switch(config)# <b>no 8021x</b>

### 3.1.14 TFTP Commands Set

Table 3.14: TFTP Commands Set

Netstar Commands	Level	Description	Defaults Example
<b>backup flash:backup_cfg</b>	<b>G</b>	Save configuration to TFTP and need to specify the IP of TFTP server and the file name of image.	switch(config)# <b>backup flash:backup_cfg</b>
<b>restore flash:restore_cfg</b>	<b>G</b>	Get configuration from TFTP server and need to specify the IP of TFTP server and the file name of image.	switch(config)# <b>restore flash:restore_cfg</b>
<b>upgrade flash:upgrade_fw</b>	<b>G</b>	Upgrade firmware by TFTP and need to specify the IP of TFTP server and the file name of image.	switch(config)# <b>upgrade flash:upgrade_fw</b>

### 3.1.15 SystemLog, SMTP and Event

Table 3.15: SysLog,SMTP,Event Commands Set

Netstar Commands	Level	Description	Example
<b>systemlog ip</b> [IP address]	<b>G</b>	Set System log server IP address.	switch(config)# <b>systemlog ip 192.168.1.100</b>

<b>systemlog mode</b> [client server both]	<b>G</b>	Specified the log mode	switch(config)# <b>systemlog mode both</b>
<b>show systemlog</b>	<b>E</b>	Displays system log.	Switch> <b>show systemlog</b>
<b>show systemlog</b>	<b>P</b>	Show system log client & server information	switch# <b>show systemlog</b>
<b>no systemlog</b>	<b>G</b>	Disable systemlog function	switch(config)# <b>no systemlog</b>
<b>smtp enable</b>	<b>G</b>	Enable SMTP function	switch(config)# <b>smtp enable</b>
<b>smtp serverip</b> [IP address]	<b>G</b>	Configure SMTP server IP	switch(config)# <b>smtp serverip 192.168.1.5</b>
<b>smtp authentication</b>	<b>G</b>	Enable SMTP authentication	switch(config)# <b>smtp authentication</b>
<b>smtp account</b> [account]	<b>G</b>	Configure authentication account	switch(config)# <b>smtp account User</b>
<b>smtp password</b> [password]	<b>G</b>	Configure authentication password	switch(config)# <b>smtp password</b>
<b>smtp rcptemail</b> [Index] [Email address]	<b>G</b>	Configure Rcpt e-mail Address	switch(config)# <b>smtp rcptemail 1 <a href="mailto:Alert@test.com">Alert@test.com</a></b>
<b>show smtp</b>	<b>P</b>	Show the information of SMTP	switch# <b>show smtp</b>
<b>no smtp</b>	<b>G</b>	Disable SMTP function	switch(config)# <b>no smtp</b>
<b>event device-cold-start</b> [Systemlog SMTP Both]	<b>G</b>	Set cold start event type	switch(config)# <b>event device-cold-start both</b>
<b>event authentication-failure</b> [Systemlog SMTP Both]	<b>G</b>	Set Authentication failure event type	switch(config)# <b>event authentication-failure both</b>
<b>event ring-topology-change</b> [Systemlog SMTP Both]	<b>G</b>	Set X - ring topology changed event type	switch(config)# <b>event ring-topology-change both</b>
<b>event systemlog</b> [Link-UP Link-Down Both]	<b>I</b>	Set port event for system log	switch(config)# <b>interface fastethernet 3</b> switch(config-if)# <b>event systemlog both</b>
<b>event smtp</b> [Link-UP Link-Down Both]	<b>I</b>	Set port event for SMTP	switch(config)# <b>interface fastethernet 3</b> switch(config-if)# <b>event smtp both</b>
<b>show event</b>	<b>P</b>	Show event selection	switch# <b>show event</b>
<b>no event device-cold-start</b>	<b>G</b>	Disable cold start event type	switch(config)# <b>no event device-cold-start</b>
<b>no event authentication-failure</b>	<b>G</b>	Disable Authentication failure event type	switch(config)# <b>no event authentication-failure</b>
<b>no event ring-topology-change</b>	<b>G</b>	Disable X - ring topology changed event type	switch(config)# <b>no event ring-topology-change</b>
<b>no event systemlog</b>	<b>I</b>	Disable port event for system log	switch(config)# <b>interface fastethernet 3</b> switch(config-if)# <b>no event systemlog</b>
<b>no event smtp</b>	<b>I</b>	Disable port event for SMTP	switch(config)# <b>interface fastethernet 3</b> switch(config-if)# <b>no event smtp</b>
<b>show systemlog</b>	<b>P</b>	Show system log client & server information	switch# <b>show systemlog</b>

### 3.1.16 SNTP Commands Set

Table 3.16: SNTP Commands Set			
Netstar Commands	Level	Description	Example
<b>sntp enable</b>	<b>G</b>	Enable SNTP function	switch(config)# <b>sntp enable</b>
<b>sntp daylight</b>	<b>G</b>	Enable daylight saving time, if SNTP function is inactive, this command can't be applied.	switch(config)# <b>sntp daylight</b>
<b>sntp daylight-period</b> [Start time] [End time]	<b>G</b>	Set period of daylight saving time, if SNTP function is inactive, this command can't be applied. Parameter format: [yyyymmdd-hh:mm]	switch(config)# <b>sntp daylight-period 20060101-01:01 20060202-01-01</b>
<b>sntp daylight-offset</b> [Minute]	<b>G</b>	Set offset of daylight saving time, if SNTP function is inactive, this command can't be applied.	switch(config)# <b>sntp daylight-offset 3</b>
<b>sntp ip</b> [IP]	<b>G</b>	Set SNTP server IP, if SNTP function is inactive, this command can't be applied.	switch(config)# <b>sntp ip 192.169.1.1</b>
<b>sntp timezone</b> [Timezone]	<b>G</b>	Set timezone index, use "show sntp timzezone" command to get more information of index number	switch(config)# <b>sntp timezone 22</b>
<b>show sntp</b>	<b>P</b>	Show SNTP information	switch# <b>show sntp</b>

<b>show sntp timezone</b>	<b>P</b>	Show index number of time zone list	switch# <b>show sntp timezone</b>
<b>no sntp</b>	<b>G</b>	Disable SNTP function	switch(config)# <b>no sntp</b>
<b>no sntp daylight</b>	<b>G</b>	Disable daylight saving time	switch(config)# <b>no sntp daylight</b>

### 3.1.17 X-ring Commands Set

*Table 3.17: X-ring Commands Set*

Netstar Commands	Level	Description	Example
<b>ring enable</b>	<b>G</b>	Enable X-ring	switch(config)# <b>ring enable</b>
<b>ring master</b>	<b>G</b>	Enable ring master	switch(config)# <b>ring master</b>
<b>ring couplering</b>	<b>G</b>	Enable couple ring	switch(config)# <b>ring couplering</b>
<b>ring dualhoming</b>	<b>G</b>	Enable dual homing	switch(config)# <b>ring dualhoming</b>
<b>ring ringport</b> [1st Ring Port] [2nd Ring Port]	<b>G</b>	Configure 1st/2nd Ring Port	switch(config)# <b>ring ringport 7 8</b>
<b>ring couplingport</b> [Coupling Port]	<b>G</b>	Configure Coupling Port	switch(config)# <b>ring couplingport 1</b>
<b>ring controlport</b> [Control Port]	<b>G</b>	Configure Control Port	switch(config)# <b>ring controlport 2</b>
<b>ring homingport</b> [Dual Homing Port]	<b>G</b>	Configure Dual Homing Port	switch(config)# <b>ring homingport 3</b>
<b>show ring</b>	<b>P</b>	Show the information of X - Ring	switch# <b>show ring</b>
<b>no ring</b>	<b>G</b>	Disable X-ring	switch(config)# <b>no ring</b>
<b>no ring master</b>	<b>G</b>	Disable ring master	switch(config)# <b>no ring master</b>
<b>no ring couplering</b>	<b>G</b>	Disable couple ring	switch(config)# <b>no ring couplering</b>
<b>no ring dualhoming</b>	<b>G</b>	Disable dual homing	switch(config)# <b>no ring dualhoming</b>



## 3.2 Web Browser

EKI-7657C provides a convenient configuring way via web browser. You can follow the steps below to access EKI-7657C.

EKI-7657C's default IP is 192.168.1.1. Make sure your host PC and EKI-7657C are on the same logical sub-network.

*Warning*                      *Your host PC should be in the same VLAN setting with EKI-7657C, or the management will not be configured.*

Connect EKI-7657C to the Ethernet then your host PC could be configured via Ethernet. Or you can directly connect EKI-7657C to your host PC with a straight-through or cross over Ethernet cable.

Before to use web management, install the industrial switch on the network and make sure that any one of PCs on the network can connect with the industrial switch through the web browser. The industrial switch default value of IP, subnet mask, username and password are as below:

- IP Address: 192.168.1.1
- Subnet Mask: 255.255.255.0
- Default Gateway: 192.168.1.254
- User Name: admin
- Password: admin

Open Internet Explorer and type EKI-7657C's IP in the Address field then press Enter to open the web login page.



Figure 3.5: Type the address in the URL



Figure 3.6: Web Login Window

The default user name and password are both **admin**, fill in the user name and password then press **OK** to enter the configuration. You can change the password in the system setting.

In the main page, you can find the tree menu structure of the EKI-7657C in the left side. Click the "+" symbol to unroll the hiding hyperlink, and click the hyperlink to open the function page you want to configure.

The screenshot shows the main page of the Advantech Industrial Switch web interface. On the left is a blue sidebar menu with the following items: Open all, Main Page (highlighted with a red circle), System (expanded), System Information, IP Configuration, DHCP Server, TFTP Transaction, System Event Log, Fault Relay Alarm, SNMP, IP Security, User Authentication, Digital Input/Output, Port, Protocol, Security, Factory Default, Save Configuration, and System Reboot. The main content area is white and contains the following text:

Welcome to the

**EKI-7657C**

**7+3G port Industrial Managed Redundant Gigabit Ethernet Switch**

Copyright © 2007 Advantech Co., Ltd., all rights reserved.

Figure 3.7: Main page

### 3.2.1 System

#### System Information

Here you can view the system information and assign the system name and location to make this switch more easily to be identified on your network.

- **System Name:** Assign the name of the switch. The maximum length is 64 bytes.
- **System Description:** Displays the description of switch. Read only cannot be modified.
- **System Location:** Assign the switch physical location. The maximum length is 64 bytes.
- **System Contact:** Enter the name of contact person or organization.
- **Firmware Version:** Displays the switch's firmware version.
- **Kernel Version:** Displays the kernel software version.
- **MAC Address:** Displays the unique hardware address assigned by manufacturer (default).

*Warning*

*Don't set "0" for the first segment of the subnet mask and default gateway (000.xxx.xxx.xxx).*

*Refresh the web screen if the web could not be displayed while you change the setting.*

The screenshot displays the 'System Information' page of an ADVANTECH Industrial switch. On the left is a navigation menu with categories like 'System', 'Port', 'Protocol', and 'Security'. The main area contains a form with the following fields:

System Name	<input type="text"/>
System Description	7 10/100TX + 3 Gigabit Copper/Mini GBIC Combo Managed Indu
System Location	<input type="text"/>
System Contact	<input type="text"/>

Below the form are 'Apply' and 'Help' buttons. To the right, a table shows read-only system details:

Firmware Version	v1.06
Kernel Version	v1.64
MAC Address	001122334455

Figure 3.8: System Information

## IP Configuration

User can configure the IP Settings and DHCP client function here.

- **DHCP Client:** Enable or disable the DHCP client function. When DHCP client function is enabled, the industrial switch will be assigned an IP address from the network DHCP server. The default IP address will be replaced by the assigned IP address on DHCP server. After user click **Apply**, a popup dialog shows up. It is to inform the user that when the DHCP client is enabled, the current IP will lose and user should find the new IP on the DHCP server.
- **IP Address:** Assign the IP address that the network is using. If DHCP client function is enabled, and then the user doesn't need to assign the IP address. And, the network DHCP server will assign the IP address displaying in this column for the industrial switch. The default IP is 192.168.16.1.
- **Subnet Mask:** Assign the subnet mask to the IP address. If DHCP client function is enabled, and then the user does not need to assign the subnet mask.
- **Gateway:** Assign the network gateway for the industrial switch. The default gateway is 192.168.16.254.
- **DNS1:** The abbreviation of Domain Name Server—an Internet service that translate domain name into IP addresses. Domain name are alphabetic which are easy to be remembered. Because the Internet is based on IP address; every time you use a domain name, therefore, a DNS service must translate the name into the corresponding IP address. For example, the domain name **www.net.com** might translate to 192.168.1.1
- **DNS2:** The backup for DNS1. When DNS1 cannot function, DNS2 will then replace DNS1 immediately.
- And then, click

**ADVANTECH**

Open all

- System Information
- IP Configuration
- DHCP Server
- TFTP Transaction
- System Event Log
- Fault Relay Alarm
- SNTP
- IP Security
- User Authentication
- Digital Input/Output
- Port
- Protocol
- Security
- Factory Default
- Save Configuration
- System Reboot

## IP Configuration

DHCP Client :

IP Address	192.168.1.1
Subnet Mask	255.255.255.0
Gateway	192.168.1.254
DNS1	0.0.0.0
DNS2	0.0.0.0

Figure 3.9: IP Configuration

## DHCP Server—System configuration

DHCP is the abbreviation of Dynamic Host Configuration Protocol that is a protocol for assigning dynamic IP addresses to devices on a network. With dynamic addressing, a device can have a different IP address every time it connects to the network. In some systems, the device's IP address can even change while it is still connected. DHCP also supports a mix of static and dynamic IP addresses. Dynamic addressing simplifies network administration because the software keeps track of IP addresses rather than requiring an administrator to manage the task. This means that a new computer can be added to a network without the hassle of manually assigning it a unique IP address.

The system provides the DHCP server function. The system provides the DHCP server function. Having enabled the DHCP server function, the switch system can be a DHCP server.

- **DHCP Server:** Enable or Disable the DHCP Server function. Enable—the switch will be the DHCP server on your local network.
- **Low IP Address:** Type in an IP address. Low IP address is the beginning of the dynamic IP range. For example, dynamic IP is in the range between 192.168.1.100 ~ 192.168.1.200. In contrast, 192.168.1.100 is the Low IP address.
- **High IP Address:** Type in an IP address. High IP address is the end of the dynamic IP range. For example, dynamic IP is in the range between 192.168.1.100 ~ 192.168.1.200. In contrast, 192.168.1.200 is the High IP address.
- **Subnet Mask:** Type in the subnet mask of the IP configuration.
- **Gateway:** Type in the IP address of the gateway in your network.
- **DNS:** Type in the Domain Name Server IP Address in your network.
- **Lease Time (sec):** It is the time period that system will reset the dynamic IP assignment to ensure the dynamic IP will not be occupied for a long time or the server doesn't know that the dynamic IP is idle.
- And then, click .

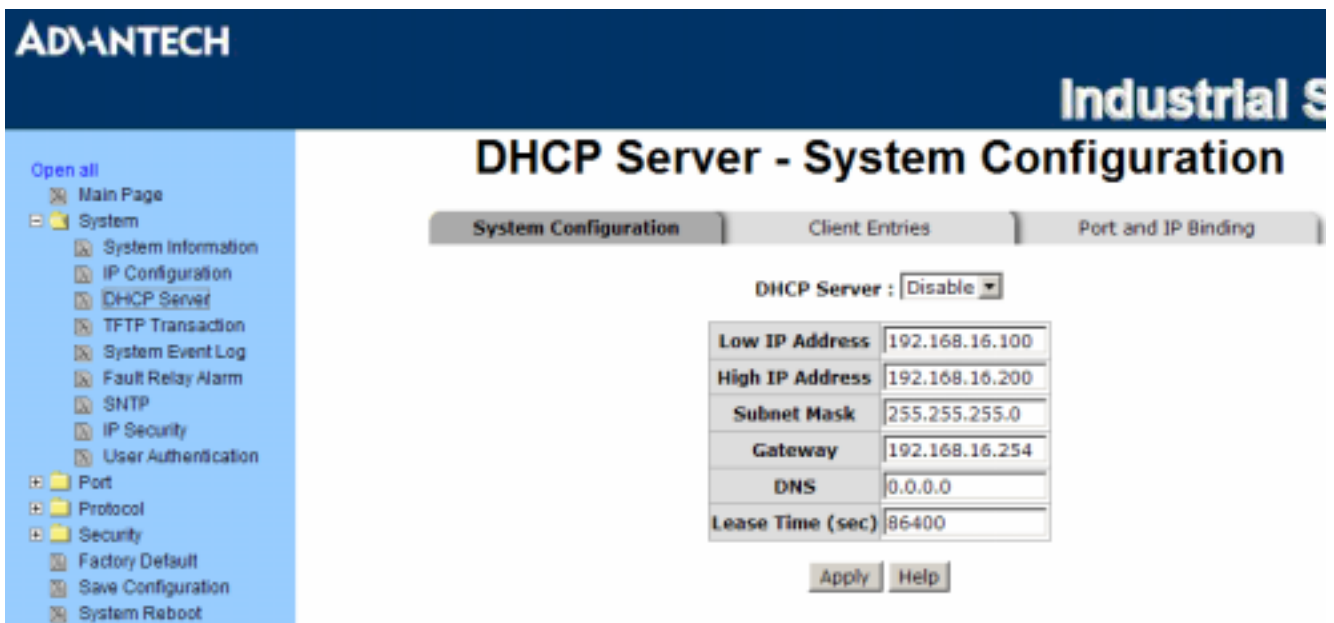

Figure 3.10: DHCP Server – System Configuration

## DHCP Client—System Configuration

When the DHCP server function is active, the system will collect the DHCP client information and display it here.

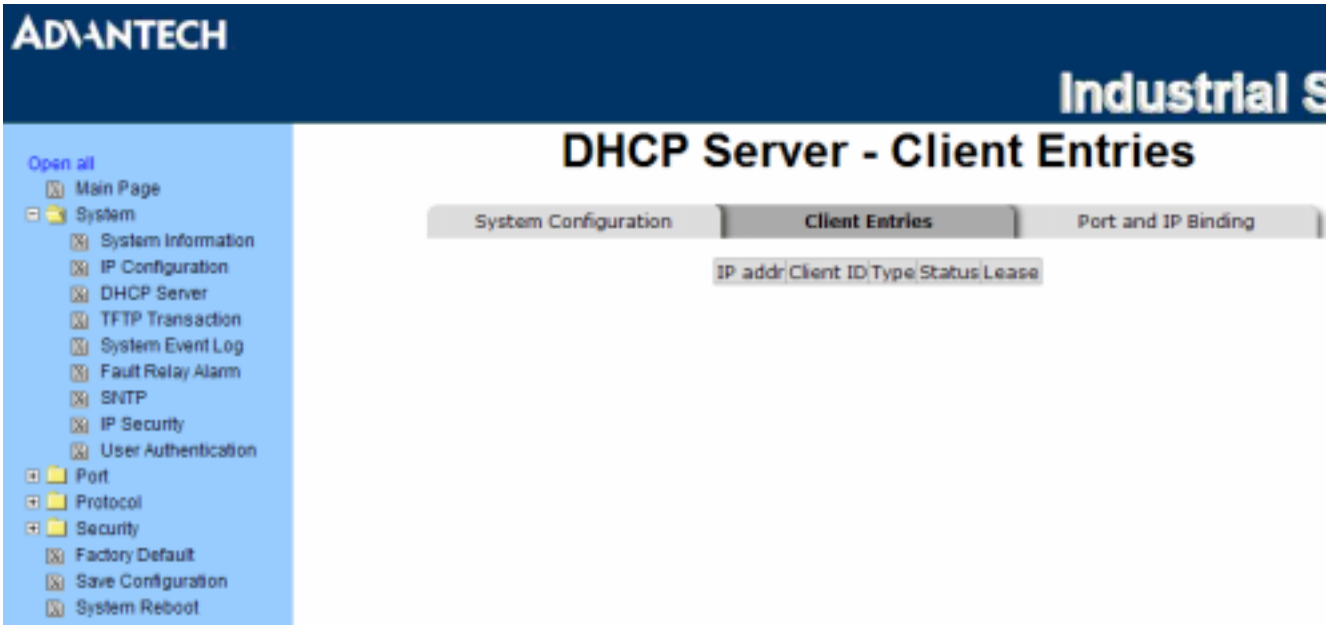

Figure 3.11: DHCP Server – Client Entries

### DHCP Server—Port and IP Bindings

Assign the dynamic IP address to the port. When the device is connecting to the port and asks for IP assigning, the system will assign the IP address that has been assigned before to the connected device.

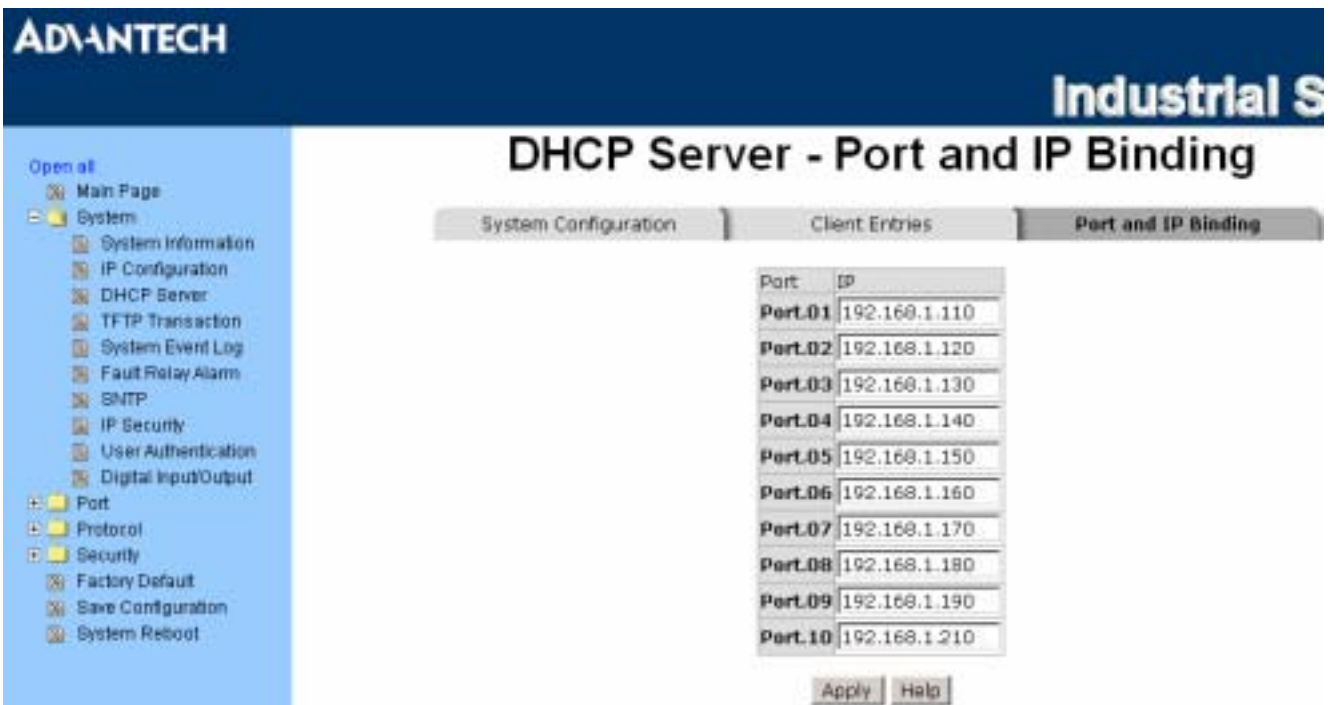

Figure 3.12: DHCP Server – Port and IP Binding

### TFTP—Update Firmware

Trivial File Transfer Protocol (TFTP) is a very simple file transfer protocol, with the functionality of a very basic form of FTP. It provides the functions to allow the user to update the switch firmware. Before updating, make sure you have your TFTP server ready and the firmware image is on the TFTP server.

- **TFTP Server IP Address:** Fill in your TFTP server IP.
- **Firmware File Name:** Type in the name of firmware image.
- And then, click .

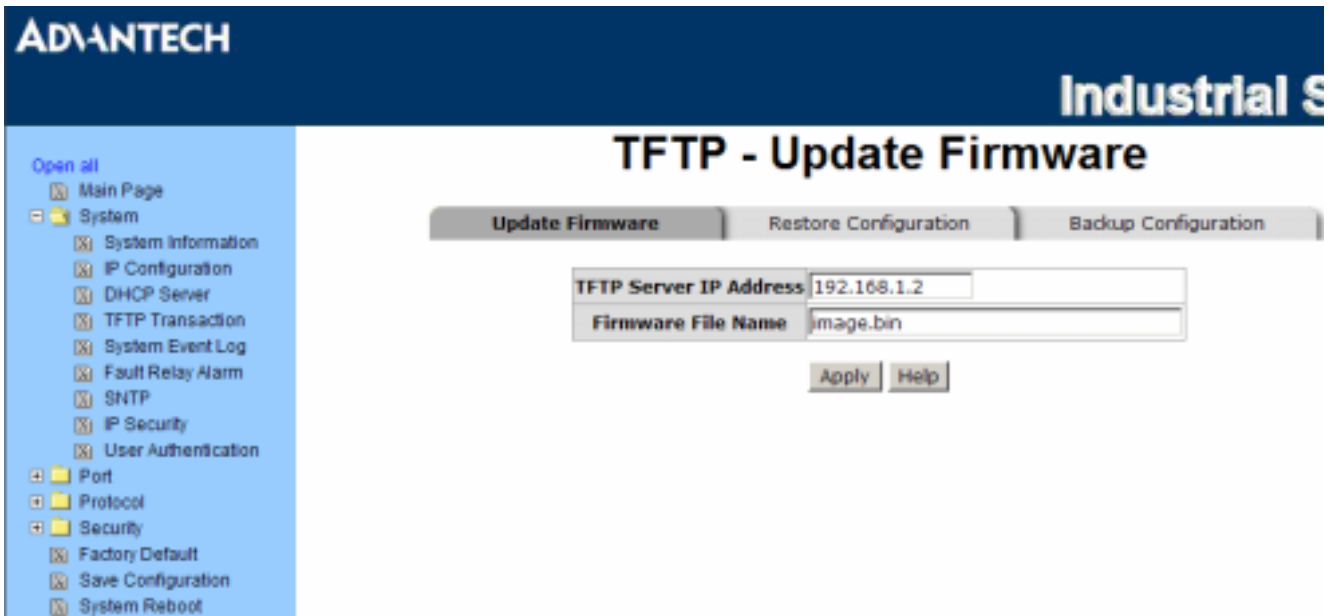

Figure 3.13: TFTP – Update Firmware

### TFTP—Restore Configuration

You can restore the configuration from TFTP server. Before doing that, you must put the image file on TFTP server first and the switch will download back the flash image.

- **TFTP Server IP Address:** Fill in the TFTP server IP.
- **Restore File Name:** Fill in the correct restore file name.
- Click .

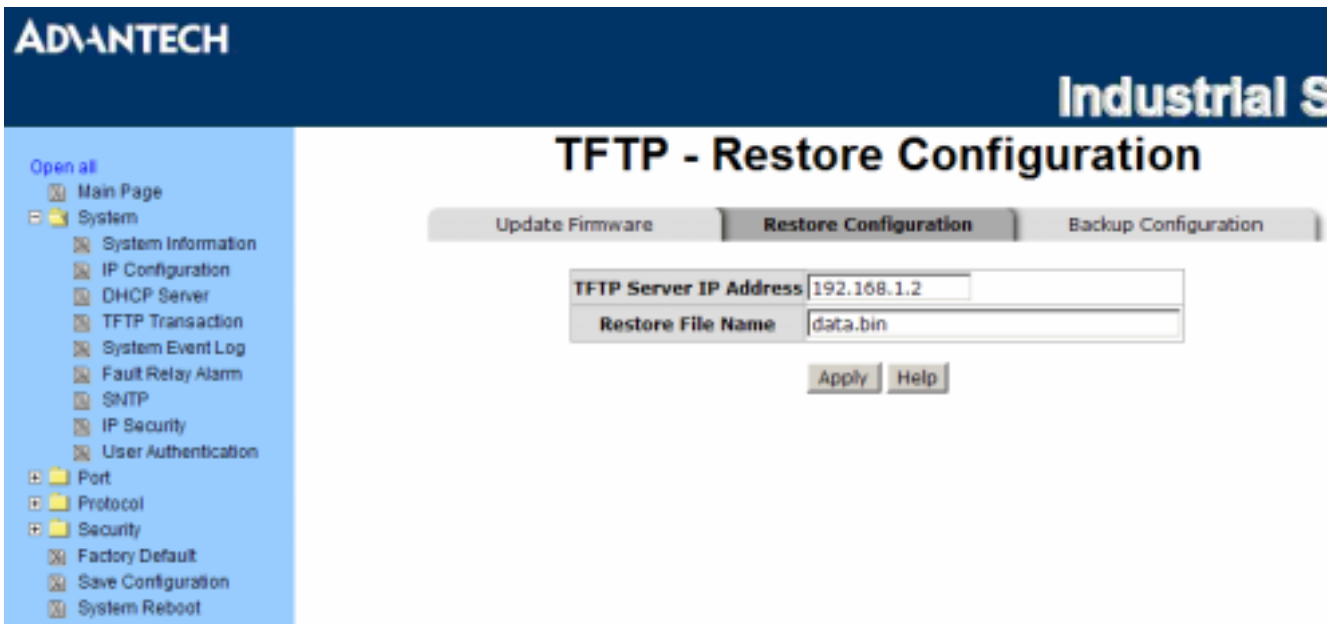

Figure 3.14: TFTP – Restore Configuration

### TFTP—Backup Configuration

You can save current Flash ROM value from the switch to TFTP server for restoring later.

- **TFTP Server IP Address:** Fill in the TFTP server IP
- **Backup File Name:** Fill in the file name
- Click **Apply**.

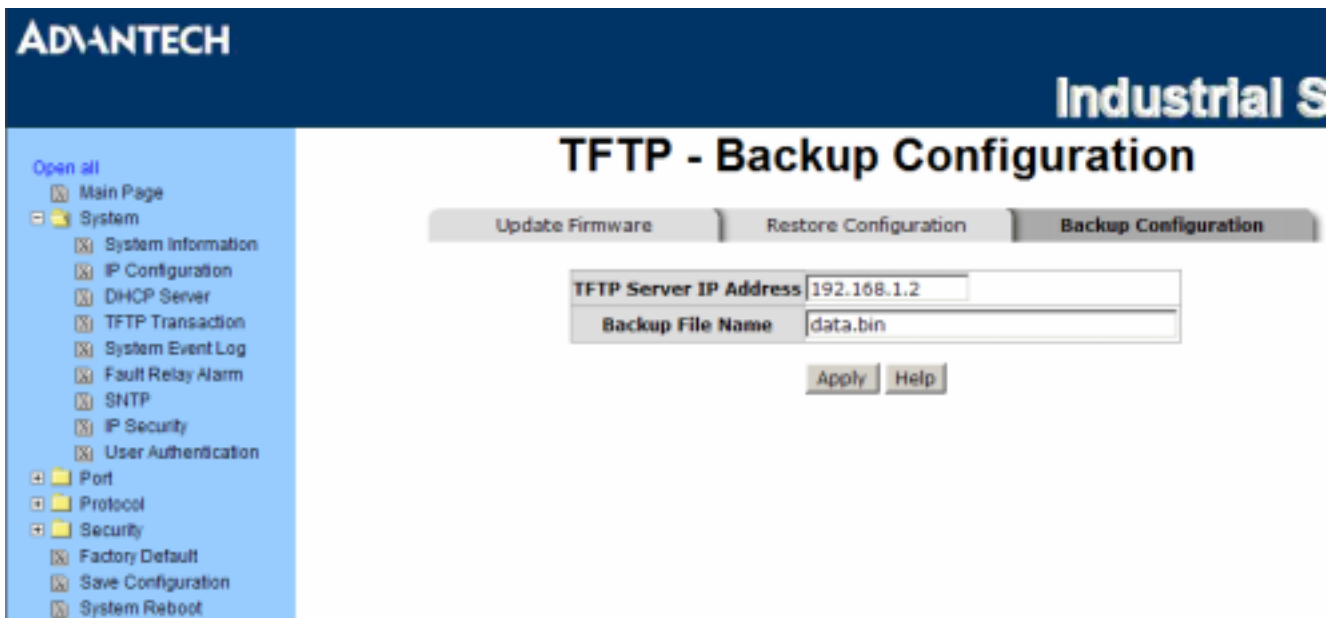

Figure 3.15: TFTP – Backup Configuration



## System Event Log—Syslog Configuration

Configure the system event mode to collect system log.

- **Syslog Client Mode:** Select the system log mode—**Client Only**, **Server Only**, or **Both**.
- **System Log Server IP Address:** Assign the system log server IP.
- When Syslog Client Mode is set as **Client Only**, the system event log will only be reserved in the switch's RAM until next reboot. When Syslog Client Mode is set as **Server Only**, the system log will only be sent to the syslog server and you have to type the IP address in the Syslog Server IP Address column. If the Syslog Client Mode is set as **Both**, the system log will be reserved in the switch's RAM and sent to server.
- Click **Reload** to refresh the events log.
- Click **Clear** to clear all current events log.
- After configuring, click **Apply**.

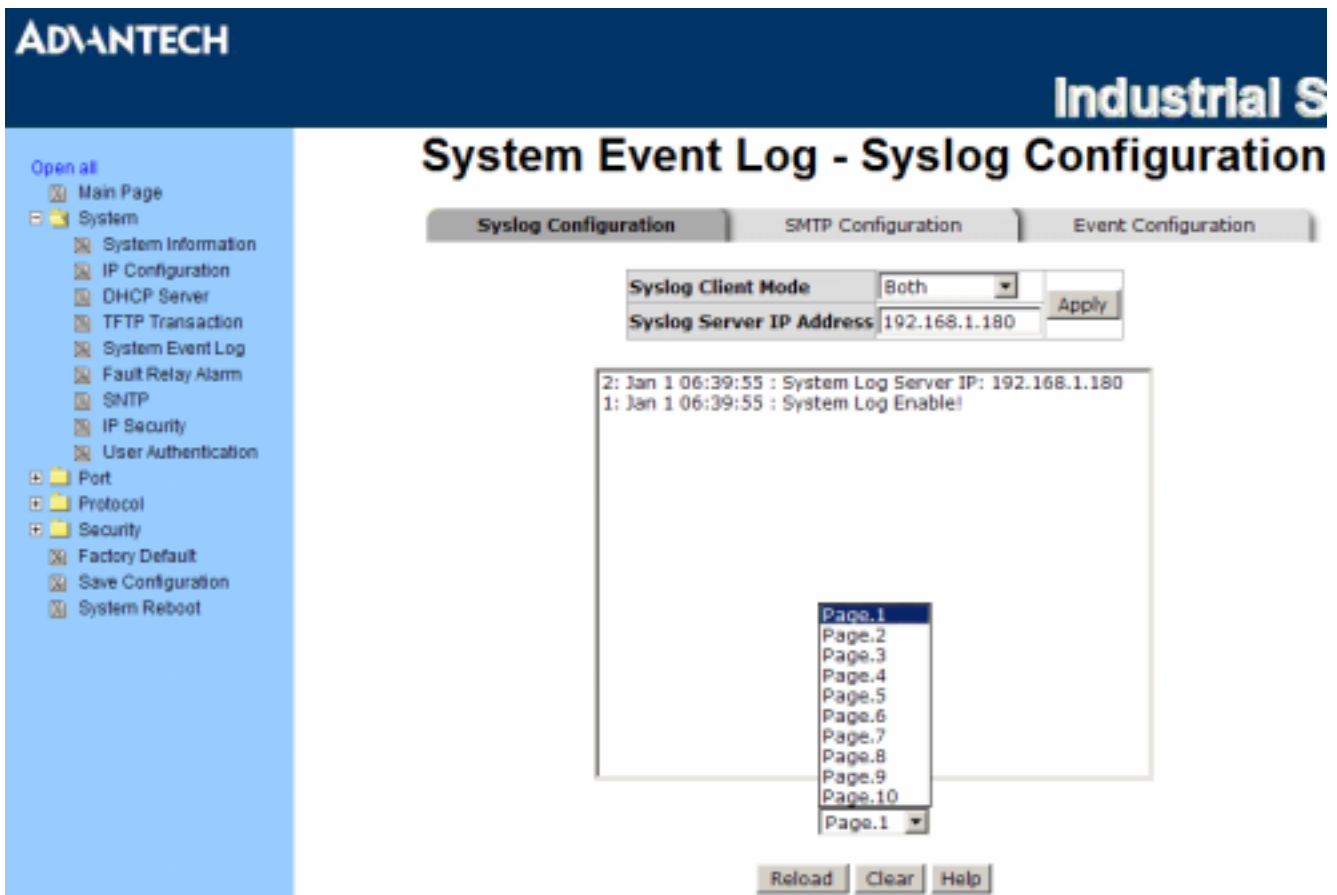

Figure 3.16: Syslog Configuration

## System Event Log—SMTP Configuration

You can set up the mail server IP, mail account, password, and forwarded email account for receiving the event alert.

- **Email Alert:** Enable or disable the email alert function.
- **SMTP Server IP:** Set up the mail server IP address (when **Email Alert** enabled, this function will then be available).

- **Sender:** Type in an alias of the switch in complete email address format, e.g. [switch01@123.com](mailto:switch01@123.com), to identify where the event log comes from.
- **Authentication:** Tick the checkbox to enable this function, configuring the email account and password for authentication (when **Email Alert** enabled, this function will then be available).
- **Mail Account:** Set up the email account, e.g. [Tomadmin](mailto:Tomadmin), to receive the alert. It must be an existing email account on the mail server, which you had set up in **SMTP Server IP Address** column.
- **Password:** Type in the password to the email account.
- **Confirm Password:** Reconfirm the password.
- **Rcpt e-mail Address 1 ~ 6:** You can also assign up to 6 e-mail accounts to receive the alert.
- Click  .

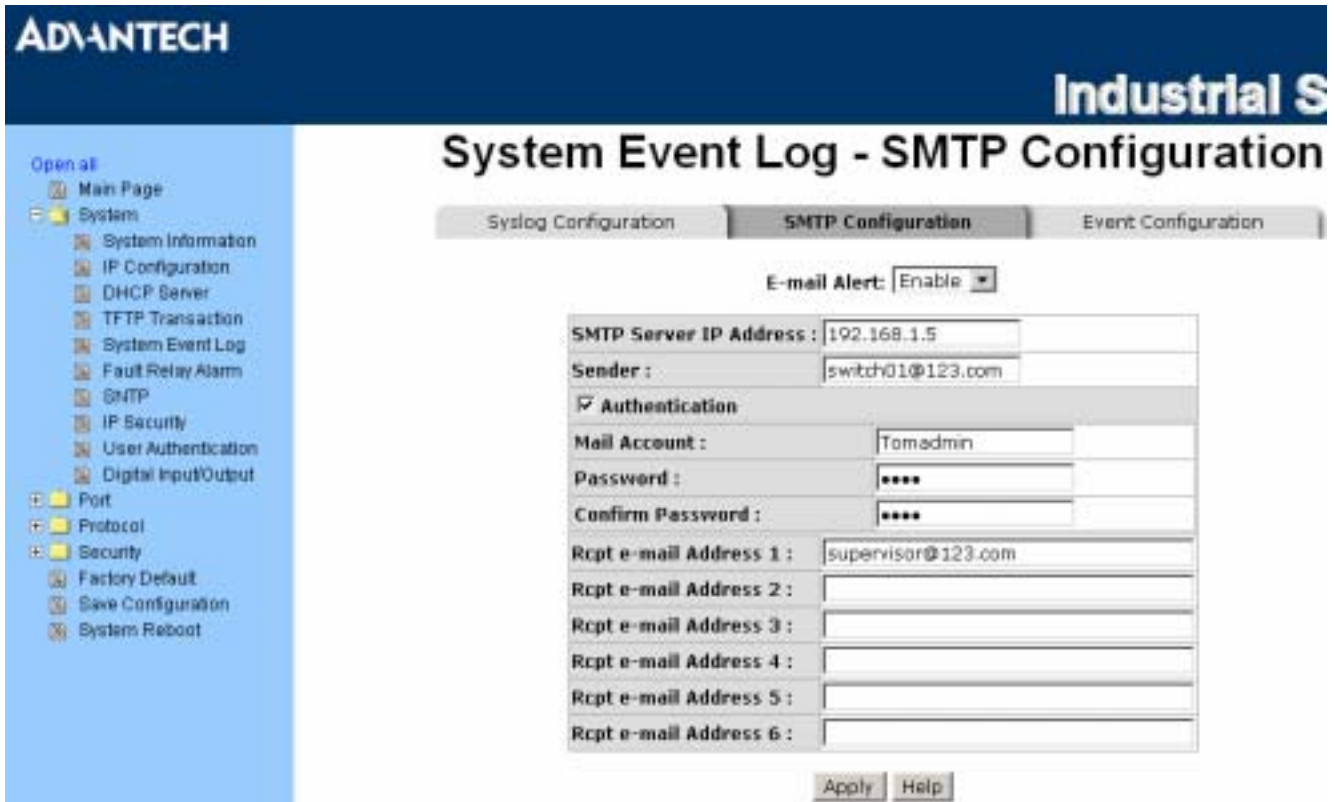

Figure 3.17: SMTP Configuration

### System Event Log—Event Configuration

When the **Syslog/SMTP** checkbox is ticked, the event log will be sent to system log server/SMTP server. Also, per port log (link up, link down, and both) events can be sent to the system log server/SMTP server with the respective checkbox ticked. After configuring, click 'Apply' to have the setting taken effect.

- **System event selection:** There are 4 event types—Device cold start, Device warm start, Authentication Failure, and X-ring topology change. Before you can tick the checkbox of each event type, the Syslog Client Mode column on the Syslog Configuration tab/E-mail Alert column on the SMTP Configuration tab must be enabled first.
  - **Device cold start:** When the device executes cold start action, the system will issue a log event.
  - **Device warm start:** When the device executes warm start, the system will issue a log event.
  - **Authentication Failure:** When the SNMP authentication fails, the system will issue a log event.
  - **X-ring topology change:** When the X-ring topology has changed, the system will issue a log event.

- **Port event selection:** Also, before the drop-down menu items are available, the Syslog Client Mode column on the Syslog Configuration tab/E-mail Alert column on the SMTP Configuration tab must be enabled first. Those drop-down menu items have 3 selections—Link UP, Link Down, and Link UP & Link Down. Disable means no event will be sent to the system log server/SMTP server.

- **Link UP:** The system will issue a log message when port connection links up only.
- **Link Down:** The system will issue a log message when port connection links down only.
- **Link UP & Link Down:** The system will issue a log message when port connection is up and down.

**System event selection**

Event Type	Syslog	SMTP
Device cold start	<input checked="" type="checkbox"/>	<input type="checkbox"/>
Device warm start	<input checked="" type="checkbox"/>	<input checked="" type="checkbox"/>
Authentication failure	<input checked="" type="checkbox"/>	<input type="checkbox"/>
X-Ring topology change	<input type="checkbox"/>	<input checked="" type="checkbox"/>

**Port event selection**

Port	Syslog	SMTP
Port.01	Disable	Disable
Port.02	Link Up Link Down Link Up & Link Down	Disable
Port.03	Disable	Disable
Port.04	Disable	Disable
Port.05	Disable	Disable
Port.06	Disable	Disable
Port.07	Disable	Disable
Port.08	Disable	Disable
Port.09	Disable	Disable
Port.10	Disable	Disable

Apply Help

Figure 3.18: Event Configuration

### Fault Relay Alarm

- **Power Failure:** Tick the checkbox to enable the function of lighting up the **FAULT** LED on the panel when power fails.
- **Port Link Down/Broken:** Tick the checkbox to enable the function of lighting up **FAULT** LED on the panel when ports' states are link-down or broken.

Open all

- Main Page
- System
  - System Information
  - IP Configuration
  - DHCP Server
  - TFTP Transaction
  - System Event Log
  - Fault Relay Alarm
  - SNTP
  - IP Security
  - User Authentication
  - Digital Input/Output
- Port
- Protocol
- Security
- Factory Default
- Save Configuration
- System Reboot

## Fault Relay Alarm

Power Failure	
<input checked="" type="checkbox"/> Power 1	<input checked="" type="checkbox"/> Power 2
Port Link Down/Broken	
<input type="checkbox"/> Port 1	<input type="checkbox"/> Port 2
<input checked="" type="checkbox"/> Port 3	<input type="checkbox"/> Port 4
<input type="checkbox"/> Port 5	<input type="checkbox"/> Port 6
<input type="checkbox"/> Port 7	<input type="checkbox"/> Port 8
<input checked="" type="checkbox"/> Port 9	<input checked="" type="checkbox"/> Port 10

Apply

Figure 3.19: Fault Relay Alarm

## SNTP Configuration

You can configure the SNTP (Simple Network Time Protocol) settings which allow you to synchronize switch clocks on the Internet.

- **SNTP Client:** Enable/disable SNTP function to get the time from the SNTP server.
- **Daylight Saving Time:** Enable/disable daylight saving time function. When daylight saving time is enabled, you need to configure the daylight saving time period.
- **UTC Timezone:** Set the switch location time zone. The following table lists the different location time zone for your reference.

<i>Table 3.18: UTC Timezone</i>		
Local Time Zone	Conversion from UTC	Time at 12:00 UTC
November Time Zone	- 1 hour	11am
Oscar Time Zone	-2 hours	10 am
ADT - Atlantic Daylight	-3 hours	9 am
AST - Atlantic Standard EDT - Eastern Daylight	-4 hours	8 am
EST - Eastern Standard CDT - Central Daylight	-5 hours	7 am
CST - Central Standard MDT - Mountain Daylight	-6 hours	6 am
MST - Mountain Standard PDT - Pacific Daylight	-7 hours	5 am
PST - Pacific Standard ADT - Alaskan Daylight	-8 hours	4 am
ALA - Alaskan Standard	-9 hours	3 am
HAW - Hawaiian Standard	-10 hours	2 am
Nome, Alaska	-11 hours	1 am
CET - Central European FWT - French Winter MET - Middle European MEWT - Middle European Winter SWT - Swedish Winter	+1 hour	1 pm
EET - Eastern European, USSR Zone 1	+2 hours	2 pm
BT - Baghdad, USSR Zone 2	+3 hours	3 pm
ZP4 - USSR Zone 3	+4 hours	4 pm

ZP5 - USSR Zone 4	+5 hours	5 pm
ZP6 - USSR Zone 5	+6 hours	6 pm
WAST - West Australian Standard	+7 hours	7 pm
CCT - China Coast, USSR Zone 7	+8 hours	8 pm
JST - Japan Standard, USSR Zone 8	+9 hours	9 pm
EAST - East Australian Standard GST Guam Standard, USSR Zone 9	+10 hours	10 pm
IDLE - International Date Line NZST - New Zealand Standard NZT - New Zealand	+12 hours	Midnight

- **SNTP Sever URL:** Set the SNTP server IP address.
- **Switch Timer:** Displays the current time of the switch.
- **Daylight Saving Period:** Set up the Daylight Saving beginning time and Daylight Saving ending time. Both will be different in every year.
- **Daylight Saving Offset (mins):** For non-US and European countries, specify the amount of time for day light savings.
- Click  .

Figure 3.20: SNTP Configuration

## IP Security

IP security function allows the user to assign 10 specific IP addresses that have permission to access the switch through the web browser for the securing switch management.

- **IP Security Mode:** When this option is in **Enable** mode, the **Enable HTTP Server** and **Enable Telnet Server** checkboxes will then be available.
- **Enable HTTP Server:** When this checkbox is ticked, the IP addresses among Security IP1 ~ IP10 will be allowed to access this switch via HTTP service.
- **Enable Telnet Server:** When this checkbox is ticked, the IP addresses among Security IP1 ~ IP10 will be allowed to access this switch via telnet service.
- **Security IP 1 ~ 10:** The system allows the user to assign up to 10 specific IP addresses for access security. Only these 10 IP addresses can access and manage the switch through the HTTP/Telnet service.
- And then, click **Apply** to apply the configuration.

Note

Remember to execute the “Save Configuration” action, otherwise the new configuration will lose when switch power off.

**ADVANTECH**

## IP Security

IP Security Mode:

Enable HTTP Server

Enable Telnet Server

Security IP1	192.168.1.77
Security IP2	192.168.1.89
Security IP3	192.168.1.120
Security IP4	0.0.0.0
Security IP5	0.0.0.0
Security IP6	0.0.0.0
Security IP7	0.0.0.0
Security IP8	0.0.0.0
Security IP9	0.0.0.0
Security IP10	0.0.0.0

Figure 3.21: IP Security

## User Authentication

Change web management login user name and password for the management security issue.

- **User name:** Key in the new user name (The default is “admin”).
- **Password:** Key in the new password (The default is “admin”).
- **Confirm password:** Re-type the new password.
- And then, click **Apply** to apply the configuration.



Figure 3.22: User Authentication



## Digital Input/Output

The EKI-7657C contains two digital inputs and two digital outputs. The digital inputs may be used to receive the voltage-changing signal of the remote equipment to sense the state of the remote equipment like heater, pump, and other electrical equipment. Therefore the switch can be configured to send system log, SMTP and SNMP traps to syslog server, SMTP server and SNMP trap station respectively (please refer to **System Event Log** and **SNMP configuration** section). Outputs are open-collector transistor switches used to connect to the external device like alarm buzzer or LED to inform the user of the port/power status.

### Digital Input

- When First/Second Digital Input function is enabled, their **Digital Input**, **Event Description** and **Action** setting items will then be available respectively.
- **Digital Input:** Choose the transition type to trigger DI0/DI1.
  - **Low→High:** Having focused this radio button, DI0/DI1 will only report the status when the external device's voltage changes from low to high.
  - **High→Low:** Having focused this radio button, DI0/DI1 will only report the status when the external device's voltage changes from high to low.
- **Event description:** Please fill in the description for the event.
- **Action:** Tick the check boxes to decide whether or not to send the events via Syslog, SMTP, or SNMP Trap.

### Digital Output

- When First/Second Digital Output function is enabled, their **Condition** and **Action** setting items will then be available respectively.
- **Condition:** The system will send an electrical Low-to-High or High-to-Low signal to First Digital Output (DO0)/Second Digital Output (DO1) when the condition of ticked checkbox is met.
  - **Port Fail:** Having ticked this checkbox, DO0/DO1 will output an electrical Low-to-High or High-to-Low signal when port failure occurs.
  - **Power Fail:** Having ticked this checkbox, DO0/DO1 will output an electrical Low-to-High or High-to-Low signal when power failure occurs.
- **Action:** Choose the output type of electrical signal.
  - **Low→High:** Having focused this radio button, DO0/DO1 will output an electrical signal of Low-to-High when the condition of the ticked checkbox is met (port/power failure occurs).
  - **High→Low:** Having focused this radio button, DO0/DO1 will output an electrical signal of Low-to-High when the condition of the ticked checkbox is met (port/power failure occurs).

*Note* Besides ticking the checkboxes in the Condition column field, the power/port failure checkboxes of **Fault Relay Alarm** have to be ticked as the precondition. Please refer to **Fault Relay Alarm** section. Also, please notice that the digital output can't connect to the external device using power higher than 40V/200mA.

Open all

- [-] Main Page
- [+] System
  - [-] System Information
  - [-] IP Configuration
  - [-] DHCP Server
  - [-] TFTP Transaction
  - [-] System Event Log
  - [-] Fault Relay Alarm
  - [-] SNMP
  - [-] IP Security
  - [-] User Authentication
  - [-] Digital Input/Output
- [+] Port
- [+] Protocol
- [+] Security
  - [-] Factory Default
  - [-] Save Configuration
  - [-] System Reboot

## Digital Input

First Digital Input :

Digital Input	<input checked="" type="radio"/> Low->High <input type="radio"/> High->Low
Event Description	<input type="text"/>
Action	<input type="checkbox"/> Syslog <input checked="" type="checkbox"/> SMTP <input checked="" type="checkbox"/> SNMP Trap

Second Digital Input :

Digital Input	<input type="radio"/> Low->High <input checked="" type="radio"/> High->Low
Event description	<input type="text"/>
Action	<input checked="" type="checkbox"/> Syslog <input checked="" type="checkbox"/> SMTP <input checked="" type="checkbox"/> SNMP Trap

## Digital Output

First Digital Output :

Condition	<input checked="" type="checkbox"/> Port Fail <input type="checkbox"/> Power Fail
Action	<input checked="" type="radio"/> Low->High <input type="radio"/> High->Low

Second Digital Output :

Condition	<input checked="" type="checkbox"/> Port Fail <input checked="" type="checkbox"/> Power Fail
Action	<input type="radio"/> Low->High <input checked="" type="radio"/> High->Low

Figure 3.23: Digital Input/Output interface

### 3.2.2 Port

Port setting includes Port Statistics, Port Control, Port Trunk, Port Mirroring, and Rate Limiting. The user can use this interface to set the parameters and control the packet flow among the ports.

#### Port Statistics

The following information provides the current port statistic information.

- **Port:** Displays the port number.
- **Type:** Displays the media type of the port.
- **Link:** The status of linking—'Up' or 'Down'.
- **State:** The user can set the state of the port as 'Enable' or 'Disable' via Port Control. When the state is disabled, the port will not transmit or receive any packet.
- **Tx Good Packet:** The counts of transmitting good packets via this port.
- **Tx Bad Packet:** The counts of transmitting bad packets (including undersize [less than 64 bytes], oversize, CRC Align errors, fragments and jabbers packets) via this port.
- **Rx Good Packet:** The counts of receiving good packets via this port.
- **Rx Bad Packet:** The counts of receiving bad packets (including undersize [less than 64 bytes], oversize, CRC error, fragments and jabbers) via this port.
- **Tx Abort Packet:** The aborted packet while transmitting.
- **Packet Collision:** The counts of collision packet.
- **Packet Dropped:** The counts of dropped packet.
- **Rx Bcast Packet:** The counts of broadcast packet.
- **Rx Mcast Packet:** The counts of multicast packet.
- Click  to clean all counts.

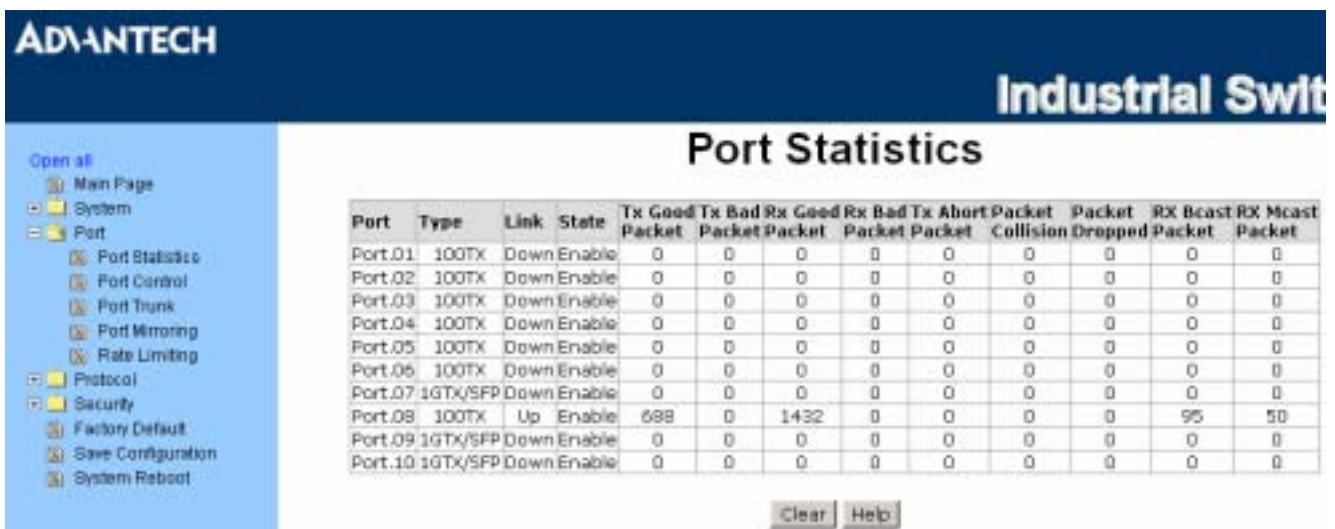

Figure 3.24: Port Statistics

## Port Control

In Port Control, you can pull down the selection items to set the parameters of each port to control the transmitting/receiving packets.

- **Port:** Select the port that you want to configure.
- **State:** Current port status. The port can be set to disable or enable mode. If the port state is set as 'Disable', it will not receive or transmit any packet.
- **Negotiation:** Auto and Force. Being set as Auto, the speed and duplex mode are negotiated automatically. When you set it as Force, you have to assign the speed and duplex mode manually.
- **Speed:** It is available for selecting when the Negotiation column is set as Force. When the Negotiation column is set as Auto, this column is read only.
- **Duplex:** It is available for selecting when the Negotiation column is set as Force. When the Negotiation column is set as Auto, this column is read only.
- **Flow Control:** Set flow control function as Enable or Disable. When enabled, once the device exceed the input data rate of another device as a result the receiving device will send a PAUSE frame which halts the transmission of the sender for a specified period of time. When disabled, the receiving device will drop the packet if too much to process.
- **Security:** Once the Security selection is set as 'On', any access from the device which connects to this port will be blocked unless the MAC address of the device is included in the static MAC address table. See the segment of Static MAC Table.
- Click **Apply** to make the configuration effective.

Port	State	Negotiation	Speed	Duplex	Flow Control	Security
Port.01	Enable	Auto	100	Full	Enable	Off
Port.02						
Port.03						
Port.04						

Port	Group ID	Type	Link	State	Negotiation	Speed Config	Duplex Actual	Flow Control Config	Flow Control Actual	Security
Port.01	N/A	100TX	Down	Enable	Auto	100 Full	N/A	Enable	N/A	OFF
Port.02	N/A	100TX	Down	Enable	Auto	100 Full	N/A	Enable	N/A	OFF
Port.03	N/A	100TX	Down	Enable	Auto	100 Full	N/A	Enable	N/A	OFF
Port.04	N/A	100TX	Down	Enable	Auto	100 Full	N/A	Enable	N/A	OFF
Port.05	N/A	100TX	Down	Enable	Auto	100 Full	N/A	Enable	N/A	OFF
Port.06	N/A	100TX	Down	Enable	Auto	100 Full	N/A	Enable	N/A	OFF
Port.07	N/A	1GTX/SFP	Down	Enable	Auto	1G Full	N/A	Enable	N/A	OFF
Port.08	N/A	100TX	Up	Enable	Auto	100 Full	100 Full	Enable	ON	OFF
Port.09	N/A	1GTX/SFP	Down	Enable	Auto	1G Full	N/A	Enable	N/A	OFF
Port.10	N/A	1GTX/SFP	Down	Enable	Auto	1G Full	N/A	Enable	N/A	OFF

Figure 3.25: Port Control

## Port Trunk

The Link Aggregation Control Protocol (LACP) provides a standardized means for exchanging information between Partner Systems on a link to allow their Link Aggregation Control instances to reach agreement on the identity of the Link Aggregation Group to which the link belongs, move the link to that Link Aggregation Group, and enable its transmission and reception functions in an orderly manner. Link aggregation lets you group up to 4 ports into one dedicated connections. This feature can expand bandwidth to a device on the network. **LACP operation requires full-duplex mode**, more detail information refers to IEEE 802.3ad.

### Aggregator setting

- **System Priority:** A value which is used to identify the active LACP. The switch with the lowest value has the highest priority and is selected as the active LACP.
- **Group ID:** There are four trunk groups to be selected. Choose the 'Group ID' and click .
- **LACP:** When enabled, the trunk group is using LACP. A port which joins an LACP trunk group has to make an agreement with its member ports first. When disabled, the trunk group is a static trunk group. The advantage of having the LACP disabled is that a port joins the trunk group without any handshaking with its member ports. But member ports won't know that they should be aggregated together to form a logic trunk group.
- **Work ports:** This column field allows the user to type in the total number of active port up to four. With LACP trunk group, you create a trunk group by connecting two or more switches (e.g. you assign four ports to be the members of a trunk group whose work ports column field is set as two). The exceed ports are standby (the **Aggregator Information** tab will show standby status on the exceed ports) and can be aggregated if work ports fail. If it is a static trunk group, the number of work ports must equal the total number of group member ports.
- Select the ports to join the trunk group. The system allows four ports maximum to be aggregated in a trunk group. Click  to add the port which is focused to the left field. To remove unwanted ports, select the port and click .
- When LACP enabled, you can configure LACP Active/Passive status for each port on State Activity page.
- Click .
- Use  to delete Trunk Group. Select the Group ID and click .

### Port Trunk - Aggregator Setting

Aggregator Setting | Aggregator Information | State Activity

System Priority: 1

Group ID	Trunk.1	Select
Lacp	Enable	
Work Ports	2	
Port.01 Port.02	<<Add Remove>>	Port.03 Port.04 Port.05 Port.06 Port.07 Port.08 Port.09 Port.10

Apply | Delete | Help

Notice: The trunk function do not support GVRP and X-Ring.

Figure 3.26: 2 work ports with LACP enabled

#### Aggregator Information

When you have set up the aggregator setting with LACP disabled, you will see the local static trunk group information as below.

### Port Trunk - Aggregator Setting

Aggregator Setting | Aggregator Information | State Activity

System Priority: 1

Group ID	Trunk.1	Select
Lacp	Disable	
Work Ports	2	
Port.03 Port.04	<<Add Remove>>	Port.01 Port.02 Port.05 Port.06 Port.07 Port.08 Port.09 Port.10

Apply | Delete | Help

Notice: The trunk function do not support GVRP and X-Ring.

Figure 3.27: 2 work ports with LACP disabled

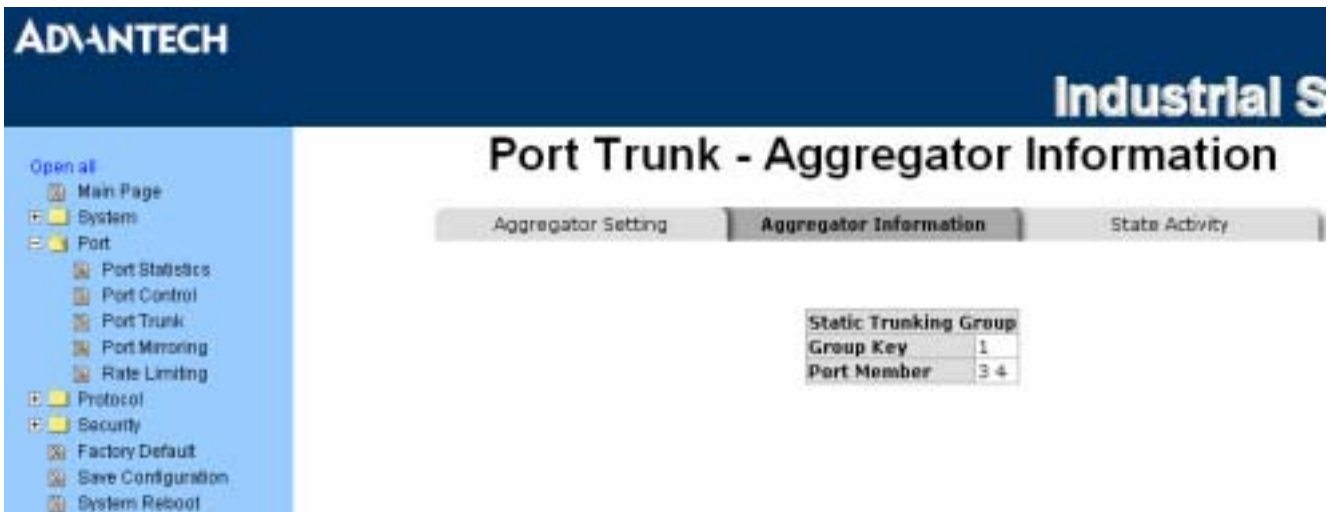

Figure 3.28: Static trunking group of 2 ports on single switch

When you have set up the aggregator setting of two interconnected switches with LACP enabled, you will see the respective LACP trunk group information as below. 'Actor' means the switch which is connecting to the host computer.



Figure 3.29: Aggregator Information

### State Activity

Having set up the LACP aggregator on the tab of Aggregator Setting, you can configure the state activity for the members of the LACP trunk group. You can tick or cancel the checkbox beside the state display. When you remove the tick mark to the port and click  , the port state activity will change to **Passive**.

- **Active:** The port automatically sends LACP protocol packets.
- **Passive:** The port does not automatically send LACP protocol packets, and responds only if it receives LACP protocol packets from the opposite device.

Note

**A link** having either two active LACP nodes or one active node can perform dynamic LACP trunk.

**A link** having two passive LACP nodes will not perform dynamic LACP trunk

because both ports are waiting for an LACP protocol packet from the opposite device.

The screenshot displays the 'Port Trunk - State Activity' configuration page. On the left is a navigation menu with categories like System, Port, Protocol, and Security. The main content area has a title bar with 'Industrial S' and 'Port Trunk - State Activity'. Below the title bar are three tabs: 'Aggregator Setting', 'Aggregator Information', and 'State Activity'. The 'State Activity' tab is active, showing a table with the following data:

Port	LACP State	Activity	Port	LACP State	Activity
1	N/A		2	N/A	
3	N/A		4	N/A	
5	<input checked="" type="checkbox"/>	Active	6	<input checked="" type="checkbox"/>	Active
7	N/A		8	N/A	
9	N/A		10	N/A	

Below the table are 'Apply' and 'Help' buttons.

Figure 3.30: State Activity



## Port Mirroring

The Port mirroring is a method for monitoring traffic in switched networks. Traffic through ports can be monitored by one specific port which means traffic goes in or out monitored (source) ports will be duplicated into mirroring (destination) port.

- **Destination Port:** There is only one port can be selected to be the destination (mirroring) port for monitoring both RX and TX traffic which come from the source port. Or, use one of two ports for monitoring RX traffic only and the other one for TX traffic only. The user can connect the mirroring port to LAN analyzer or Netxray.
- **Source Port:** The ports that the user wants to monitor. All monitored port traffic will be copied to mirroring (destination) port. The user can select multiple source ports by ticking the **RX** or **TX** checkboxes to be monitored.
- And then, click  .

	Destination Port		Source Port	
	RX	TX	RX	TX
Port.01	<input type="radio"/>	<input checked="" type="radio"/>	<input checked="" type="checkbox"/>	<input checked="" type="checkbox"/>
Port.02	<input type="radio"/>	<input type="radio"/>	<input checked="" type="checkbox"/>	<input type="checkbox"/>
Port.03	<input checked="" type="radio"/>	<input type="radio"/>	<input type="checkbox"/>	<input checked="" type="checkbox"/>
Port.04	<input type="radio"/>	<input type="radio"/>	<input type="checkbox"/>	<input checked="" type="checkbox"/>
Port.05	<input type="radio"/>	<input type="radio"/>	<input checked="" type="checkbox"/>	<input checked="" type="checkbox"/>
Port.06	<input type="radio"/>	<input type="radio"/>	<input type="checkbox"/>	<input checked="" type="checkbox"/>
Port.07	<input type="radio"/>	<input type="radio"/>	<input checked="" type="checkbox"/>	<input type="checkbox"/>
Port.08	<input type="radio"/>	<input type="radio"/>	<input checked="" type="checkbox"/>	<input type="checkbox"/>
Port.09	<input type="radio"/>	<input type="radio"/>	<input checked="" type="checkbox"/>	<input type="checkbox"/>
Port.10	<input type="radio"/>	<input type="radio"/>	<input type="checkbox"/>	<input checked="" type="checkbox"/>

Figure 3.31: Port Mirroring

## Rate Limiting

Here you can set up every port's frame limitation type and bandwidth rate.

- **Ingress Limit Frame type:** Select the frame type you want to filter. The frame types have 4 options for selecting: **All**, **Broadcast/Multicast/Flooded Unicast**, **Broadcast/Multicast**, and **Broadcast only**. The four frame type options are for ingress frames limitation. The egress rate only supports 'All' type.

All ports support port ingress and egress rate control. For example, assume port 1 is 10Mbps; the user can set the effective egress rate of port 1 as 1Mbps, ingress rate 500Kbps. The switch performs the ingress rate by packet counter to meet the specified rate

- **Ingress:** Enter the port effective ingress rate (The default value is "0")
- **Egress:** Enter the port effective egress rate (The default value is "0")
- And then, click  to make the settings taken effect.

**ADVANTECH** Industrial

### Rate Limiting

	Ingress Limit Frame Type	Ingress	Egress
Port.01	All	0 kbps	0 kbps
Port.02	All	0 kbps	0 kbps
Port.03	Broadcast/Multicast/Flooded Unicast	0 kbps	0 kbps
Port.04	Broadcast/Multicast	0 kbps	0 kbps
Port.05	Broadcast only	0 kbps	0 kbps
Port.06	All	0 kbps	0 kbps
Port.07	All	0 kbps	0 kbps
Port.08	All	0 kbps	0 kbps
Port.09	All	0 kbps	0 kbps
Port.10	All	0 kbps	0 kbps

Rate Range is from 100 kbps to 102400 kbps or to 256000 kbps for giga ports, and zero means no limit.

Figure 3.32: Rate Limiting

### 3.2.3 Protocol

The user can set the layer 2 protocol setting via this interface.

#### VLAN configuration

A Virtual LAN (VLAN) is a logical network grouping that limits the broadcast domain, which would allow you to isolate network traffic, so only the members of the same VLAN will receive traffic from the ones of the same VLAN. Basically, creating a VLAN from a switch is logically equivalent of reconnecting a group of network devices to another Layer 2 switch. However, all the network devices are still plugged into the same switch physically.

The switch supports **Port-based** and **802.1Q** (tagged-based) VLAN. The default configuration of VLAN operation mode is “**Disable**”.



Figure 3.33: VLAN Configuration

#### VLAN configuration - Port-based VLAN

Packets can go among only members of the same VLAN group. Note all unselected ports are treated as belonging to another single VLAN. If the port-based VLAN enabled, the VLAN-tagging is ignored.

In order for an end station to send packets to different VLAN groups, it itself has to be either capable of tagging packets it sends with VLAN tags or attached to a VLAN-aware bridge that is capable of classifying and tagging the packet with different VLAN ID based on not only default PVID but also other information about the packet, such as the protocol.

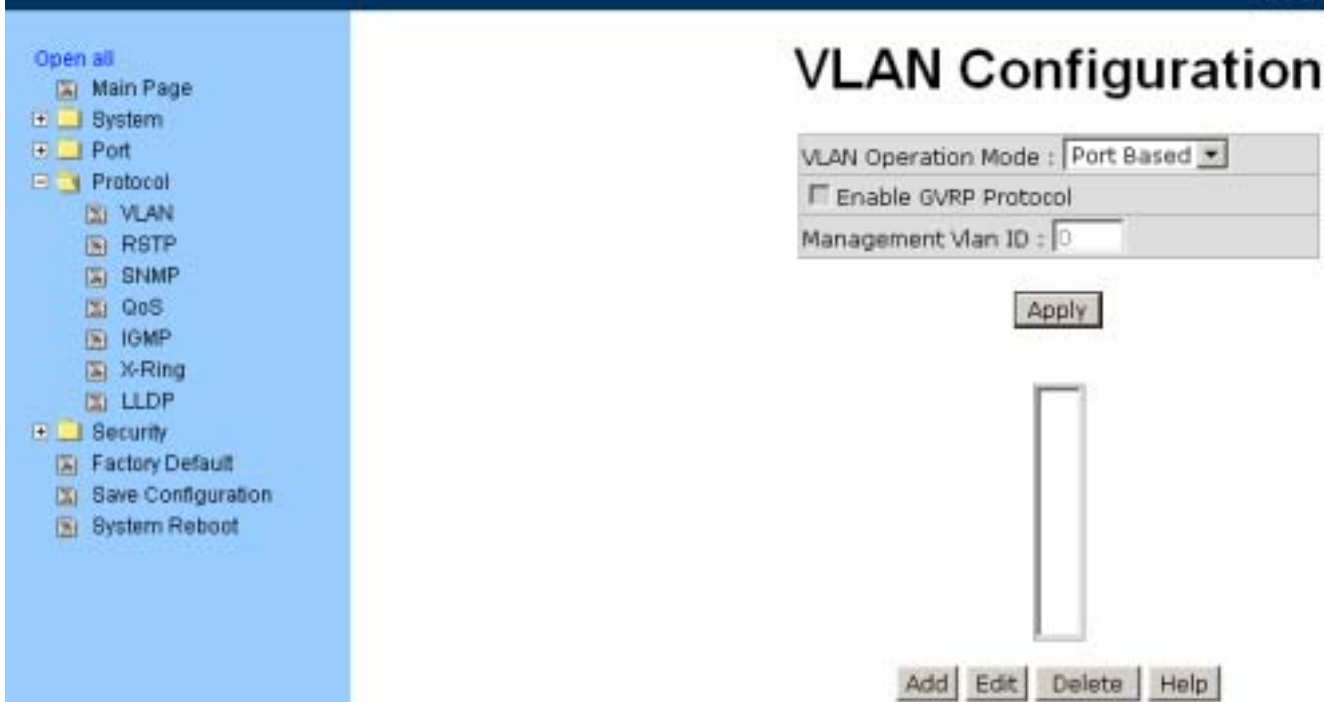

Figure 3.34: Port based mode

- Pull down the selection item and focus on **Port Based** then press **Apply** to set the VLAN Operation Mode in **Port Based** mode.
- Click **Add** to add a new VLAN group.

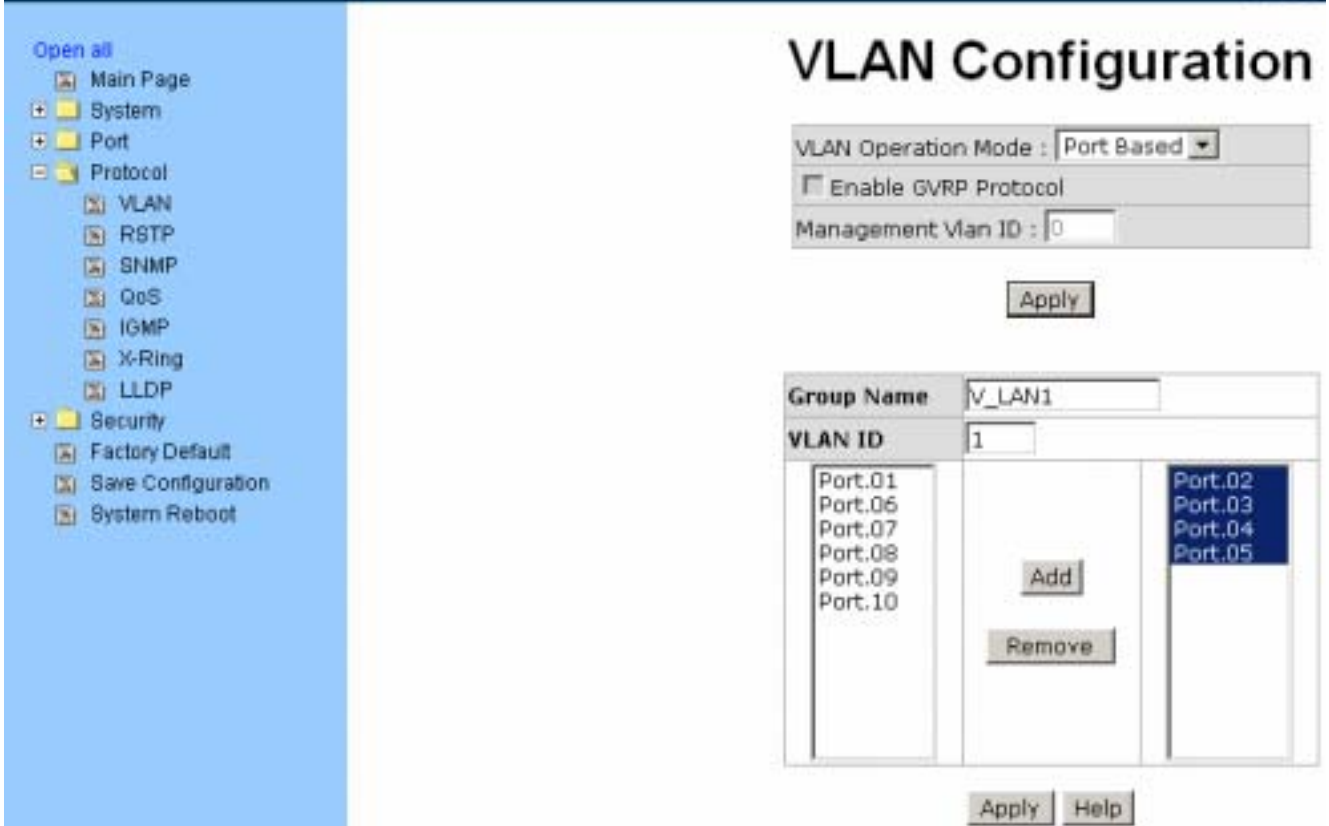

Figure 3.35: Port based mode-Add interface

- Enter the group name and VLAN ID. Add the port number having selected into the right field to group these members to be a VLAN group or remove any of them listed in the right field from the VLAN.
- And then, click **Apply** to have the settings taken effect.
- You will see the VLAN displays.

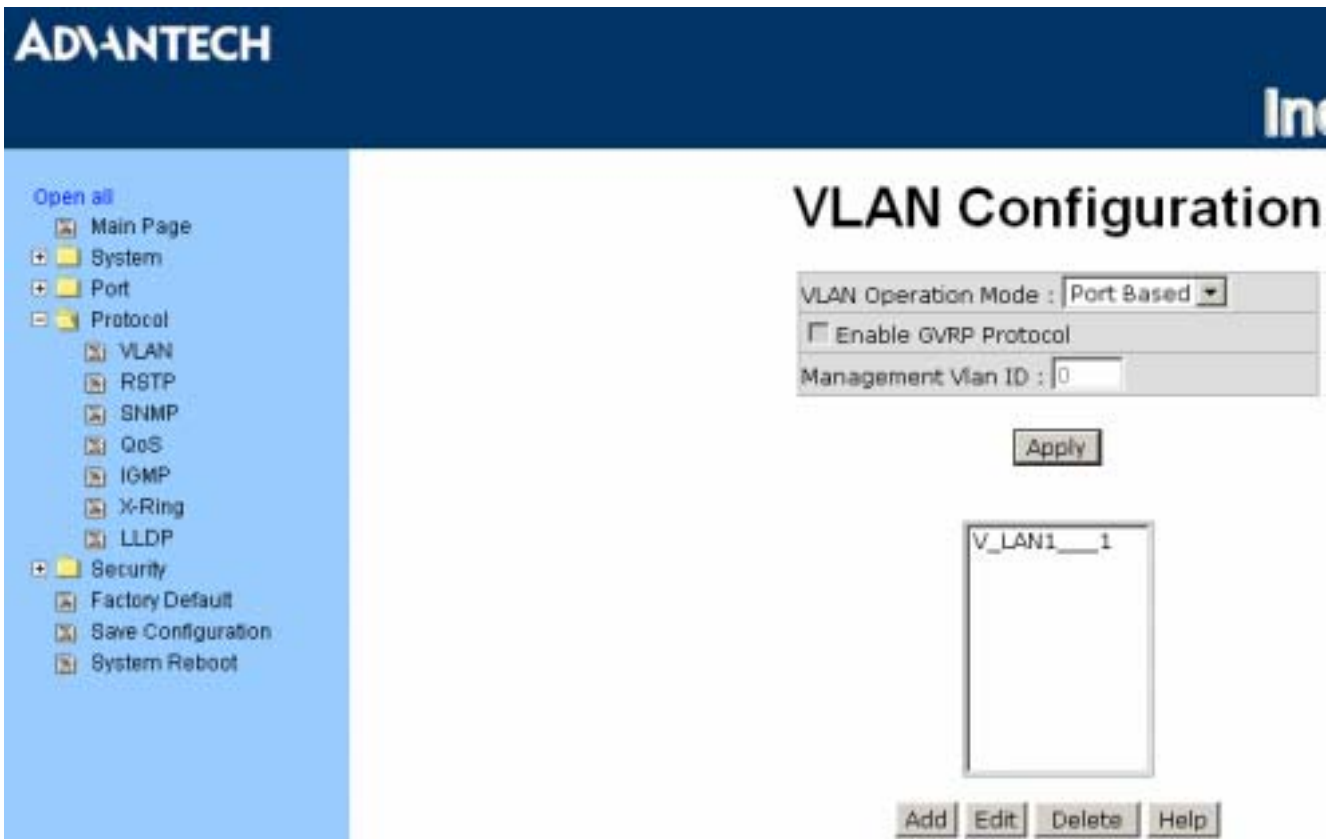

Figure 3.36: Port Based Edit/Delete interface

- Use **Delete** to delete the VLAN.
- Use **Edit** to modify group name, VLAN ID, or add/remove the members of the existing VLAN group.

*Note* Remember to execute the **“Save Configuration”** action, otherwise the new configuration will lose when switch power off.

### 802.1Q VLAN

Tagged-based VLAN is an IEEE 802.1Q specification standard. Therefore, it is possible to create a VLAN across devices from different switch vendors. IEEE 802.1Q VLAN uses a technique to insert a “tag” into the Ethernet frames. Tag contains a VLAN Identifier (VID) that indicates the VLAN numbers.

You can create Tag-based VLAN, and enable or disable GVRP protocol. There are 256 VLAN groups to provide configuration. Enable 802.1Q VLAN, all ports on the switch belong to default VLAN of VID 1. The default VLAN can't be deleted.

GVRP (GARP VLAN Registration Protocol) is a protocol that facilitates control of virtual local area networks (VLANs) within a larger network. GVRP conforms to the IEEE 802.1Q specification, which defines a method of tagging frames with VLAN configuration data. This allows network devices to dynamically exchange VLAN configuration information with other devices.

GVRP is based on GARP (Generic Attribute Registration Protocol), a protocol that defines procedures by which end stations and switches in a local area network (LAN) can register and de-register attributes, such as identifiers or addresses, with each other.

Every end station and switch thus has a current record of all the other end stations and switches that can be reached.

### 802.1Q Configuration

- Pull down the selection item and focus on **802.1Q** then press **Apply** to set the VLAN Operation Mode in **802.1Q** mode.
- **Enable GVRP Protocol:** Tick the checkbox to enable GVRP protocol. This checkbox is available while the VLAN Operation Mode is in **802.1Q** mode.
- **Management VLAN ID:** The default value is '0' which means VLAN function in 802.1Q mode is not available. While this column field is filled with a value from 1 to 4096, the member ports of this VLAN can access the management interface.
- Select the port you want to configure.
- **Link Type:** there are 3 types of link type.
  - **Access Link:** Single switch only, it allows the user to group ports by assigning the same Untagged VID. While this link type is set, the Untagged VID column field is available but the Tagged VID column field is disabled.
  - **Trunk Link:** The extended application of **Access Link**. It allows the tagged frames go across two or more switches by assigning the tag with VID to the frames. Having set this link type, the Tagged VID column field is available but the Untagged VID column field is disabled.
  - **Hybrid Link:** Both Access Link and Trunk Link are available.
- **Untagged VID:** Assign the untagged frame VID.
- **Tagged VID:** Assign the tagged frame VID.
- Click **Apply** to have the settings taken effect.

**VLAN Configuration**

VLAN Operation Mode : 802.1Q

Enable GVRP Protocol

Management Vlan ID : 0

Apply

802.1Q Configuration | Group Configuration

Port	Link Type	Untagged Vid	Tagged Vid
Port.01	Access Link	1	
Port.01	Access Link	3	
Port.02	Access Link	3	
Port.03	Hybrid Link	6	1024,
Port.04	Trunk Link	1	367,
Port.05	Hybrid Link	6	1024,
Port.06	Access Link	1	
Port.07	Access Link	1	
Port.08	Access Link	1	
Port.09	Access Link	1	
Port.10	Access Link	1	

Apply Help

Figure 3.37: 802.1Q VLAN Configuration

### Group Configuration

Edit the existing VLAN Group.

- Select the VLAN group in the table list.

- Click **Edit**.

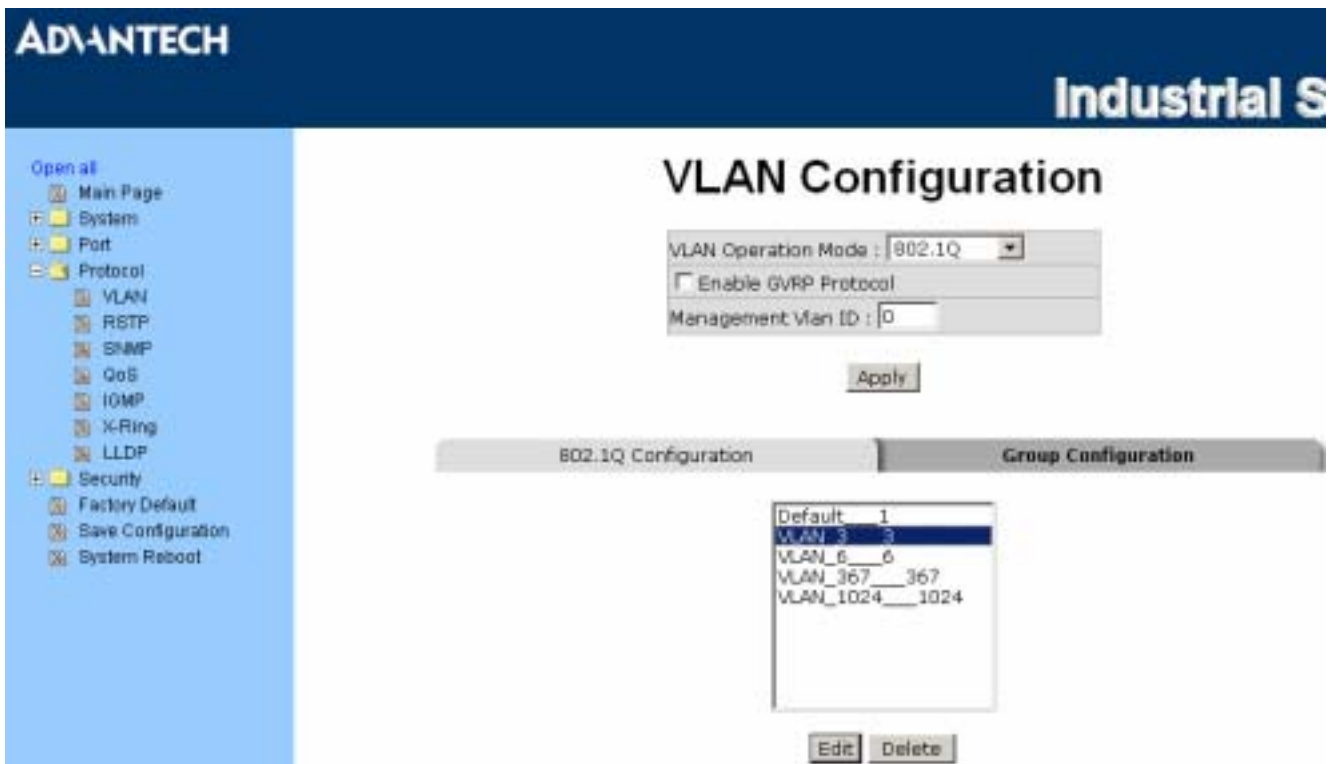

Figure 3.38: Edit Group Configuration interface

- You can Change the VLAN group name and VLAN ID.



Figure 3.39: 802.1Q Group Configuration-Edit

- Click **Apply**.

### Rapid Spanning Tree



The Rapid Spanning Tree Protocol (RSTP) is an evolution of the Spanning Tree Protocol and provides for faster spanning tree convergence after a topology change. The system also supports STP and the system will auto-detect the connected device that is running STP or RSTP protocol.

## RSTP—System Configuration

- The user can view spanning tree information of the Root Bridge.
- The user can modify RSTP state. After modification, click **Apply**.
  - **RSTP mode:** The user must enable the RSTP function first before configuring the related parameters.
  - **Priority (0-61440):** The switch with the lowest value has the highest priority and is selected as the root. If the value is changed, the user must reboot the switch. The value must be a multiple of 4096 according to the protocol standard rule.
  - **Max Age (6-40):** The number of seconds a switch waits without receiving Spanning-tree Protocol configuration messages before attempting a reconfiguration. Enter a value between 6 through 40.
  - **Hello Time (1-10):** The time that controls the switch to send out the BPDU packet to check RSTP current status. Enter a value between 1 through 10.
  - **Forward Delay Time (4-30):** The number of seconds a port waits before changing from its Rapid Spanning-Tree Protocol learning and listening states to the forwarding state. Enter a value between 4 through 30.

Note

Follow the rule to configure the MAX Age, Hello Time, and Forward Delay Time.

$2 \times (\text{Forward Delay Time value} - 1) \geq \text{Max Age value} \geq 2 \times (\text{Hello Time value} + 1)$

**ADANTECH Industrial Switch**

### RSTP - System Configuration

System Configuration | Port Configuration

RSTP Mode	Enable
Priority (0-61440)	32768
Max Age (6-40)	20
Hello Time (1-10)	2
Forward Delay Time (4-30)	15

Priority must be a multiple of 4096  
 $2 \times (\text{Forward Delay Time} - 1)$  should be greater than or equal to the Max Age.  
 The Max Age should be greater than or equal to  $2 \times (\text{Hello Time} + 1)$ .

Apply Help

Root Bridge Information	
Bridge ID	0060000F38FF501
Root Priority	32768
Root Port	Root
Root Path Cost	0
Max Age	20
Hello Time	2
Forward Delay	15

Figure 3.40: RSTP System Configuration interface

## RSTP—Port Configuration

Here you can configure the path cost and priority of each port.

- Select the port in the port column field.
- **Path Cost:** The cost of the path to the other bridge from this transmitting bridge at the specified port. Enter a number 1 through 200,000,000.
- **Priority:** Decide which port should be blocked by priority in LAN. Enter a number 0 through 240 (the port of the highest value will be blocked). The value of priority must be the multiple of 16.

- **Admin P2P:** Some of the rapid state transactions that are possible within RSTP are dependent upon whether the port concerned can only be connected to exactly one other bridge (i.e. it is served by a point-to-point LAN segment), or can be connected to two or more bridges (i.e. it is served by a shared medium LAN segment). This function allows the P2P status of the link to be manipulated administratively. True is P2P enabling. False is P2P disabling.
- **Admin Edge:** The port directly connected to end stations won't create bridging loop in the network. To configure the port as an edge port, set the port to "True" status.
- **Admin Non Stp:** The port includes the STP mathematic calculation. True is not including STP mathematic calculation. False is including the STP mathematic calculation.
- Click  .

**ADVANTECH** **Industrial S**

## RSTP - Port Configuration

System Configuration
Port Configuration

Port	Path Cost (1-200000000)	Priority (0-240)	Admin P2P	Admin Edge	Admin Non Stp
Port.01					
Port.02					
Port.03	200000	128	Auto	true	false
Port.04					
Port.05					

priority must be a multiple of 16

### RSTP Port Status

Port	Path Cost	Port Priority	Oper P2P	Oper Edge	Stp Neighbor	State	Role
Port.01	200000	128	True	True	False	Disabled	Disabled
Port.02	200000	128	True	True	False	Disabled	Disabled
Port.03	200000	128	True	True	False	Disabled	Disabled
Port.04	200000	128	True	True	False	Disabled	Disabled
Port.05	200000	128	True	True	False	Disabled	Disabled
Port.06	200000	128	True	True	False	Disabled	Disabled
Port.07	20000	128	True	True	False	Disabled	Disabled
Port.08	200000	128	True	True	False	Disabled	Disabled
Port.09	20000	128	True	True	False	Forwarding	Designated
Port.10	20000	128	True	True	False	Disabled	Disabled

Figure 3.41: RSTP Port Configuration interface

## SNMP Configuration

Simple Network Management Protocol (SNMP) is the protocol developed to manage nodes (servers, workstations, routers, switches and hubs etc.) on an IP network. SNMP enables network administrators to manage network performance, find and solve network problems, and plan for network growth. Network management systems learn of problems by receiving traps or change notices from network devices implementing SNMP.

## System Configuration

### Community Strings

Here you can define the new community string set and remove the unwanted community string.

- **String:** Fill the name string.
- **RO:** Read only. Enables requests accompanied by this community string to display MIB-object information.
- **RW:** Read write. Enables requests accompanied by this community string to display MIB-object information and to set MIB objects.
- Click **Add**.
- To remove the community string, select the community string that you have defined and click **Remove**. You cannot edit the name of the default community string set.

### Agent Mode

Select the SNMP version that you want to use and then click **Change** to switch to the selected SNMP version mode. The default value is 'SNMP v1/v2c only'

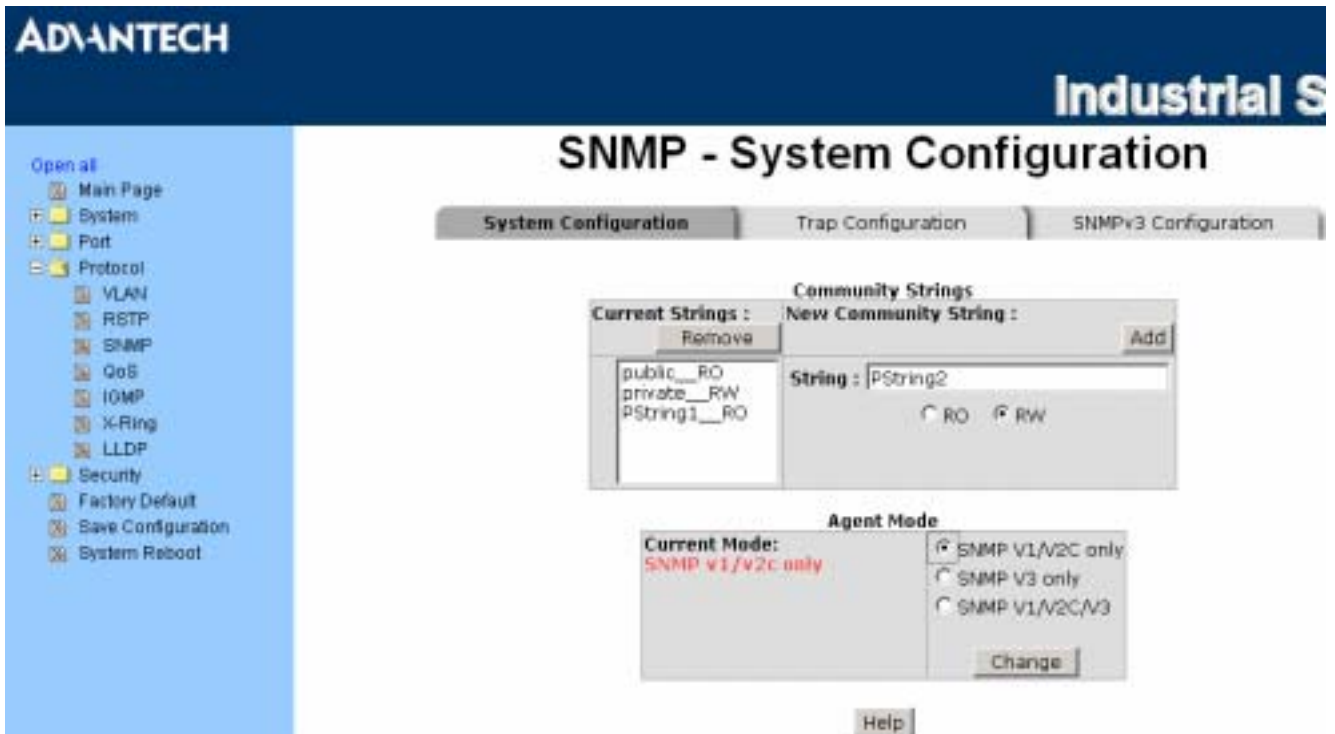

Figure 3.42: SNMP System Configuration interface

## Trap Configuration

A trap manager is a management station that receives the trap messages generated by the switch. If no trap manager is defined, no traps will be issued. Create a trap manager by entering the IP address of the station and a community string. To define a management station as a trap manager, assign an IP address, enter the SNMP community strings, and select the SNMP trap version.

- **IP Address:** Enter the IP address of the trap manager.
- **Community:** Enter the community string.
- **Trap Version:** Select the SNMP trap version type—v1 or v2c.
- Click **Add**.
- To remove the community string, select the community string listed in the current managers field and click **Remove**.

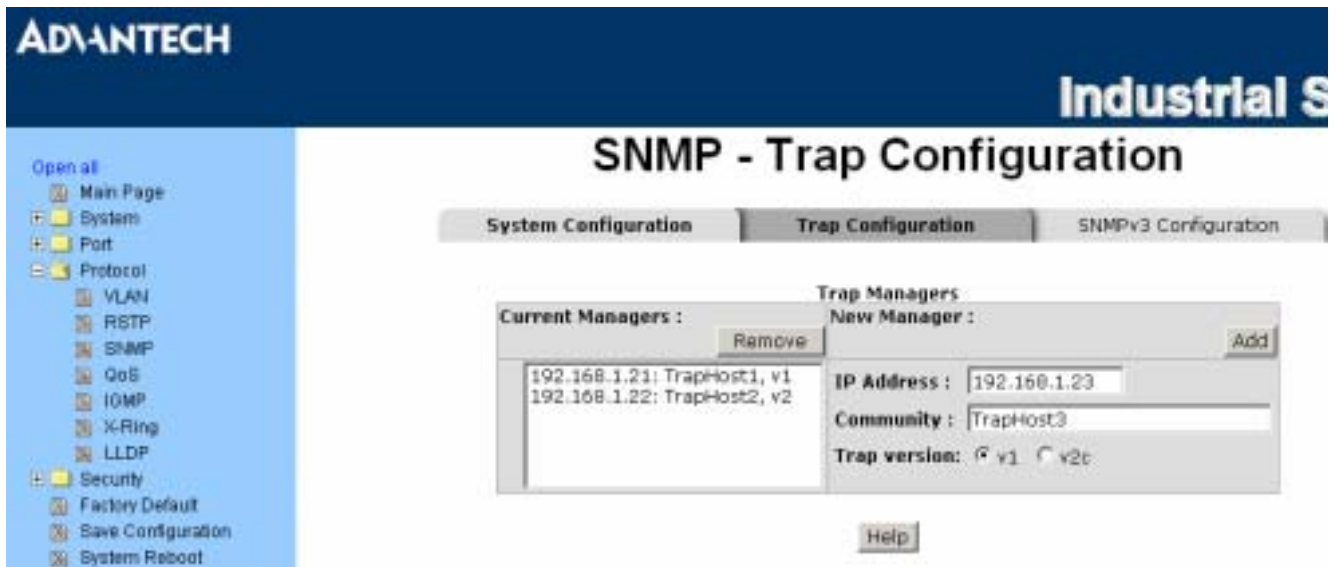

Figure 3.43: Trap Configuration interface

### SNMPV3 Configuration

Configure the SNMP V3 function.

#### Context Table

Configure SNMP v3 context table. Assign the context name of context table. Click **Add** to add context name. Click **Remove** to remove unwanted context name.

#### User Profile

Configure SNMP v3 user table.

- **User ID:** Set up the user name.
- **Authentication Password:** Set up the authentication password.
- **Privacy Password:** Set up the private password.
- Click **Add** to add context name.
- Click **Remove** to remove unwanted context name.

## SNMP - SNMPv3 Configuration

The screenshot displays the SNMPv3 Configuration interface with the following sections:

- Context Table:** A single input field for 'Context Name' and an 'Apply' button.
- User Table:**
  - Current User Profiles:** A list containing '(none)' with a 'Remove' button.
  - New User Profile:** An 'Add' button and three input fields for 'User ID', 'Authentication Password', and 'Privacy Password'.
- Group Table:**
  - Current Group content:** A list containing '(none)' with a 'Remove' button.
  - New Group Table:** An 'Add' button and two input fields for 'Security Name (User ID)' and 'Group Name'.
- Access Table:**
  - Current Access Tables:** A list containing '(none)' with a 'Remove' button.
  - New Access Table:** An 'Add' button and several input fields: 'Context Prefix', 'Group Name', 'Security Level' (with radio buttons for 'NoAuthNoPriv', 'AuthNoPriv', and 'AuthPriv'), 'Context Match Rule' (with radio buttons for 'Exact' and 'Prefix'), 'Read View Name', 'Write View Name', and 'Notify View Name'.
- MIBView Table:**
  - Current MIBTables:** A list containing '(none)' with a 'Remove' button.
  - New MIBView Table:** An 'Add' button and three input fields: 'View Name', 'SubOld-Tree', and 'Type' (with radio buttons for 'Excluded' and 'Included').

A 'Help' button is located at the bottom center. A red note at the bottom of the interface reads: "Note: Any modification of SNMPv3 tables might cause MIB accessing rejection. Please take notice of the causality between the tables before you modify these tables."

Figure 3.44: SNMP V3 Configuration interface

### Group Table

Configure SNMP v3 group table.

- **Security Name (User ID):** Assign the user name that you have set up in user table.
- **Group Name:** Set up the group name.
- Click **Add** to add context name.
- Click **Remove** to remove the unwanted context name.

## Access Table

Configure SNMP v3 access table.

- **Context Prefix:** Set up the context name.
- **Group Name:** Set up the group.
- **Security Level:** Set up the access level.
- **Context Match Rule:** Select the context match rule.
- **Read View Name:** Set up the read view.
- **Write View Name:** Set up the write view.
- **Notify View Name:** Set up the notify view.
- Click **Add** to add context name.
- Click **Remove** to remove unwanted context name.

## MIBview Table

Configure MIB view table.

- **ViewName:** Set up the name.
- **Sub-Oid Tree:** Fill the Sub OID.
- **Type:** Select the type—excluded or included.
- Click **Add** to add context name.
- Click **Remove** to remove unwanted context name.

## QoS Configuration

Here you can configure QoS policy and priority setting, per port priority setting, COS and TOS setting.

### QoS Policy and Priority Type

- **QoS Policy:** Select the QoS policy rule.
  - **Use an 8,4,2,1 weighted fair queuing scheme:** The switch will follow 8:4:2:1 rate to process priority queue from High to lowest queue. For example, while the system processing, 1 frame of the lowest queue, 2 frames of the low queue, 4 frames of the middle queue, and 8 frames of the high queue will be processed at the same time in accordance with the 8,4,2,1 policy rule.
  - **Use a strict priority scheme:** Always the higher queue will be processed first, except the higher queue is empty.
  - **Priority Type:** There are 5 priority type selections available—**Port-based**, **TOS only**, **COS only**, **TOS first**, and **COS first**. Disable means no priority type is selected.
- Click **Apply** to make the settings effective.

The screenshot shows the QoS Configuration interface. On the left is a navigation menu with categories like System, Port, Protocol, and Security. The main content area is titled 'QoS Configuration' and contains several sections:

- Qos Policy:** Two radio buttons are present: 'Use an 8,4,2,1 weighted fair queuing scheme' (selected) and 'Use a strict priority scheme'. Below is a 'Priority Type' dropdown menu set to 'Disable'.
- Port-based Priority:** A table with 10 columns labeled Port.01 through Port.10. Each cell contains a dropdown menu set to 'Lowest'.
- COS:** A table with 8 columns labeled Priority 0 through 7. Each cell contains a dropdown menu set to 'Lowest'.
- TOS:** A large table with 8 columns labeled Priority 0 through 7. Each cell contains a dropdown menu set to 'Lowest'.

Each of these sections has 'Apply' and 'Help' buttons at the bottom right.

Figure 3.45: QoS Configuration interface



### Port Base Priority

Configure the priority level for each port. With the drop-down selection item of **Priority Type** above being selected as Port-based, this control item will then be available to set the queuing policy for each port.

- **Port x:** Each port has 4 priority levels—High, Middle, Low, and Lowest—to be chosen.
- Click  to have the settings taken effect.

### COS Configuration

Set up the COS priority level. With the drop-down selection item of **Priority Type** above being selected as COS only/COS first, this control item will then be available to set the queuing policy for each port.

- **COS priority:** Set up the COS priority level 0~7—High, Middle, Low, Lowest.
- Click .

### TOS Configuration

Set up the TOS priority. With the drop-down selection item of **Priority Type** above being selected as TOS only/TOS first, this control item will then be available to set the queuing policy for each port.

- **TOS priority:** The system provides 0~63 TOS priority level. Each level has 4 types of priority—High, Middle, Low, and Lowest. The default value is 'Lowest' priority for each level. When the IP packet is received, the system will check the TOS level value in the IP packet that has received. For example, the user sets the TOS level 25 as high, the system will check the TOS value of the received IP packet. If the TOS value of received IP packet is 25 (priority = high), and then the packet priority will have highest priority.
- Click  to make the settings taken effect.

## IGMP Configuration

The Internet Group Management Protocol (IGMP) is an internal protocol of the Internet Protocol (IP) suite. IP manages multicast traffic by using switches, routers, and hosts that support IGMP. Enabling IGMP allows the ports to detect IGMP queries, report packets, and manage IP multicast traffic through the switch. IGMP have three fundamental types of message shown as follows:

Message	Description
Query	A message sent from the querier (IGMP router or switch) asking for a response from each host belonging to the multicast group.
Report	A message sent by a host to the querier to indicate that the host wants to be or is a member of a given group indicated in the report message.
Leave Group	A message sent by a host to the querier to indicate that the host has quit being a member of a specific multicast group.

The switch supports IP multicast. You can enable IGMP protocol via setting the IGMP Configuration page to see the IGMP snooping information. IP multicast addresses are in the range of 224.0.0.0 through 239.255.255.255.

- **IGMP Protocol:** Enable or disable the IGMP protocol.
- **IGMP Query:** Select the IGMP query function as Enable or Auto to set the switch as a querier for IGMP version 2 multicast networks.
- Click  .

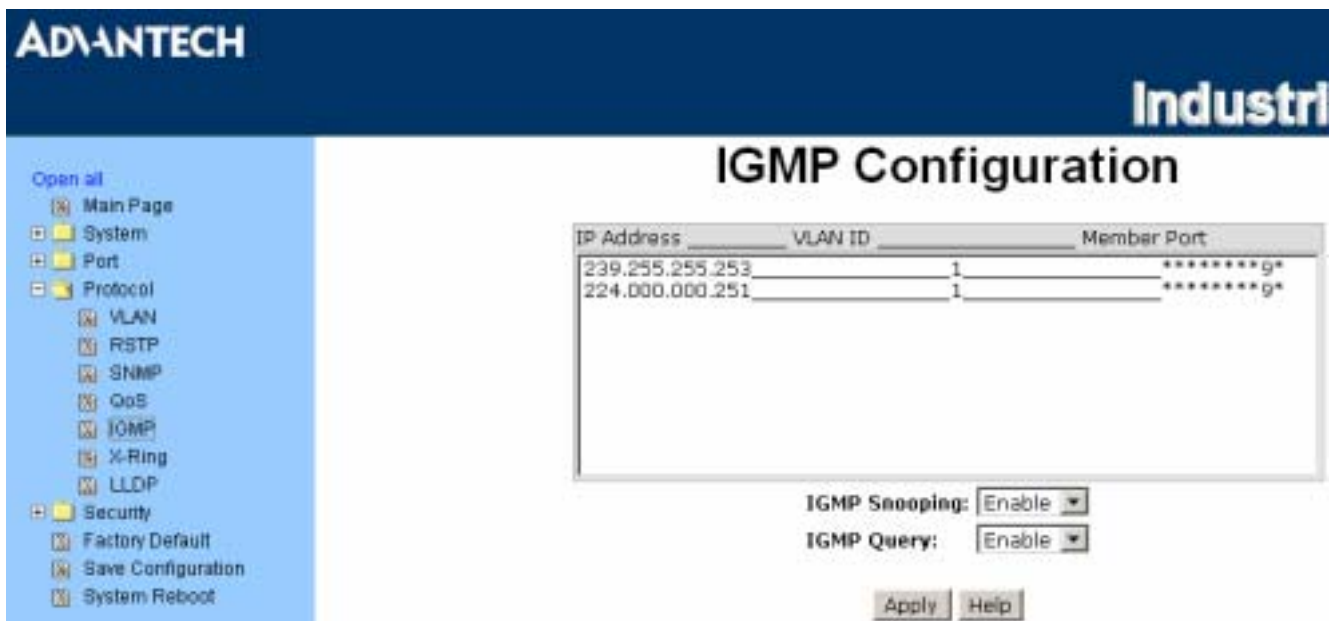

Figure 3.46: IGMP Configuration interface

## X-Ring

X-Ring provides a faster redundant recovery than Spanning Tree topology. The action is similar to STP or RSTP, but the algorithms between them are not the same.

In the X-Ring topology, every switch should be enabled with X-Ring function and two ports should be assigned as the member ports in the ring. Only one switch in the X-Ring group would be set as the master switch that one of its two member ports would be blocked, called backup port, and another port is called working port. Other switches in the X-Ring group are called working switches and their two member ports are called working ports. When the failure of network connection occurs, the backup port of the master switch (Ring Master) will automatically become a working port to recover from the failure.

The switch supports the function and interface for setting the switch as the ring master or not. The ring master can negotiate and place command to other switches in the X-Ring group. If there are 2 or more switches in master mode, the software will select the switch with lowest MAC address number as the ring master. The X-Ring master ring mode can be enabled by setting the X-Ring configuration interface. Also, the user can identify whether the switch is the ring master by checking the R.M. LED indicator on the panel of the switch.

The system also supports the **Couple Ring** that can connect 2 or more X-Ring group for the redundant backup function; **Dual Homing** function that can prevent connection lose between X-Ring group and upper level/core switch. Apart from the advantages, **Central Ring** can handle up to 4 rings in the system and has the ability to recover from failure within 10 milliseconds.

- **Enable Ring:** To enable the X-Ring function, tick the checkbox beside the **Enable Ring** string label. If this checkbox is not ticked, all the ring functions are unavailable.
  - **Enable Ring Master:** Tick the checkbox to enable this switch to be the ring master.
  - **1st & 2nd Ring Ports:** Pull down the selection menu to assign the ports as the member ports. **1<sup>st</sup> Ring Port** is the working port and **2<sup>nd</sup> Ring Port** is the backup port. When **1<sup>st</sup> Ring Port** fails, the system will automatically upgrade the **2<sup>nd</sup> Ring Port** to be the working port.
- **Enable Couple Ring:** To enable the couple ring function, tick the checkbox beside the **Enable Couple Ring** string label.
  - **Couple port:** Assign the member port which is connected to the other ring group.
  - **Control port:** When the **Enable Couple Ring** checkbox is ticked, you have to assign the control port to form a couple-ring group between the two X-rings.
- **Enable Dual Homing:** Set up one of the ports on the switch to be the Dual Homing port. For a switch, there is only one Dual Homing port. Dual Homing function only works when the X-Ring function enabled.
- **Enable Dual Ring:** When this check box is ticked, the '**Enable Ring Master**' check box will then also be enabled by the system which means this equipment is assigned as the Ring Master. The Dual Ring differs from the Couple Ring in that it only needs a unit to form a redundant linking system of two rings.
- And then, click  to apply the configuration.

### X-Ring Configuration

Open all

- Main Page
- System
- Port
- Protocol
  - VLAN
  - RSTP
  - ENMP
  - QoS
  - IGMP
  - X-Ring
  - LLDP
- Security
  - Factory Default
  - Save Configuration
  - System Reboot

<input checked="" type="checkbox"/> Enable Ring		
<input type="checkbox"/> Enable Ring Master		
1st Ring Port	Port.01	LINKDOWN
2nd Ring Port	Port.02	LINKDOWN
<input type="checkbox"/> Enable Couple Ring		
Couple Port	Port.03	LINKDOWN
Control Port	Port.04	LINKDOWN
<input type="checkbox"/> Enable Dual Homing		
Homing Port	Port.05	LINKDOWN
<input type="checkbox"/> Enable Dual Ring		
1st Ring Port	Port.01	LINKDOWN
2nd Ring Port	Port.02	LINKDOWN

Figure 3.47: X-ring interface

**Note**

When the X-Ring function enable, user must disable the RSTP. The X-Ring function and RSTP function cannot exist at the same time. Remember to execute the "Save Configuration" action, otherwise the new configuration will lose when switch power off.

## LLDP Configuration

LLDP (Link Layer Discovery Protocol) function allows the switch to advertise its information to other nodes on the network and store the information it discovers.

- **LLDP Protocol:** Disable or enable LLDP function.
- **LLDP Interval:** Set the interval of learning the information time in second.
- Click  .

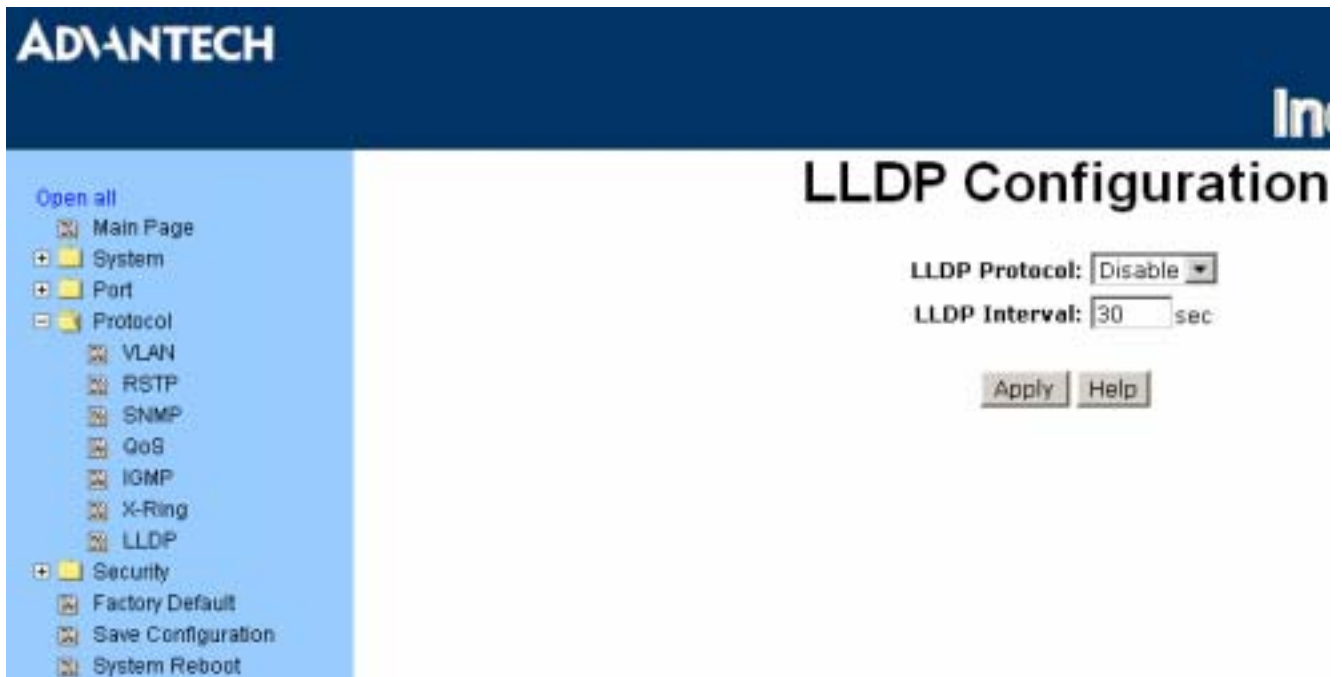

Figure 3.48: LLDP Configuration interface

### 3.2.4 Security

In this section, you can configure 802.1x and MAC address table.

#### 802.1X/RADIUS Configuration

802.1x is an IEEE authentication specification which prevents the client from connecting to a wireless access point or wired switch until it provides authority, like the user name and password that are verified by an authentication server (such as RADIUS server).

#### 802.1X/RADIUS - System Configuration

After enabling the IEEE 802.1X function, you can configure the parameters of this function.

- **IEEE 802.1x Protocol:** Enable or disable 802.1x protocol.
- **Radius Server IP:** Assign the RADIUS Server IP address.
- **Server Port:** Set the UDP destination port for authentication requests to the specified RADIUS Server.
- **Accounting Port:** Set the UDP destination port for accounting requests to the specified RADIUS Server.
- **Shared Key:** Set an encryption key for using during authentication sessions with the specified RADIUS server. This key must match the encryption key used on the RADIUS Server.
- **NAS, Identifier:** Set the identifier for the RADIUS client.
- Click  .

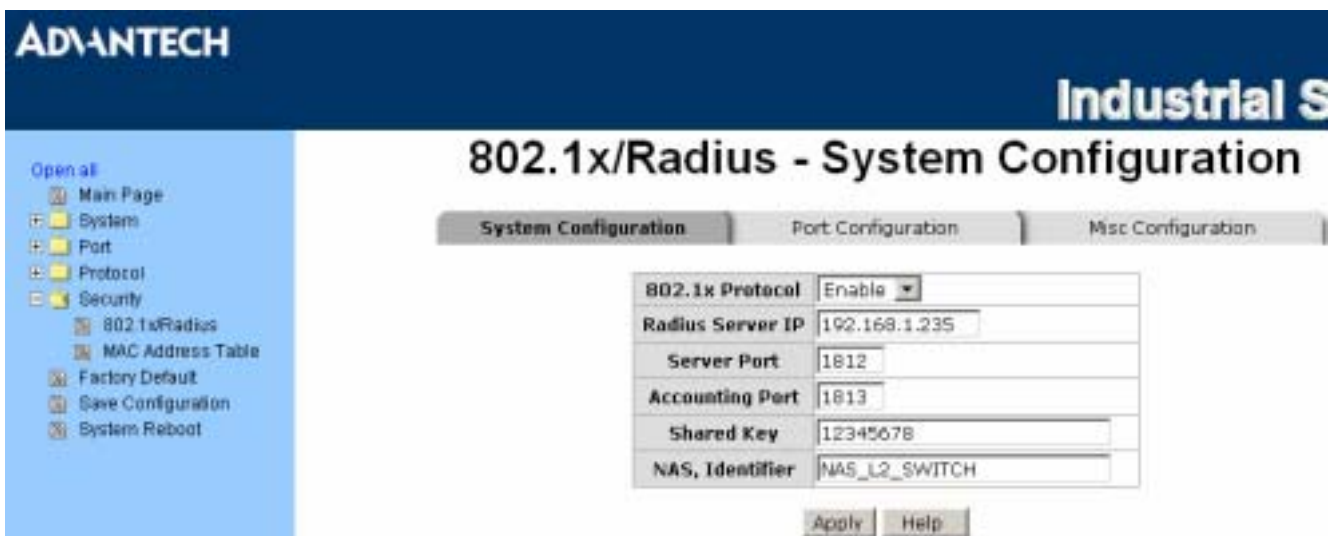

Figure 3.49: 802.1x/RADIUS System Configuration interface

#### 802.1x/RADIUS—Port Configuration

You can configure the 802.1x authentication state for each port. The state provides Disable, Accept, Reject, and Authorize.

- **Reject:** The specified port is required to be held in the unauthorized state.
- **Accept:** The specified port is required to be held in the Authorized state.
- **Authorized:** The specified port is set to the Authorized or Unauthorized state in accordance with the outcome of an authentication exchange between the Supplicant and the authentication server.
- **Disable:** When disabled, the specified port works without complying with 802.1x protocol.
- Click  .

## 802.1x/RADIUS - Port Configuration

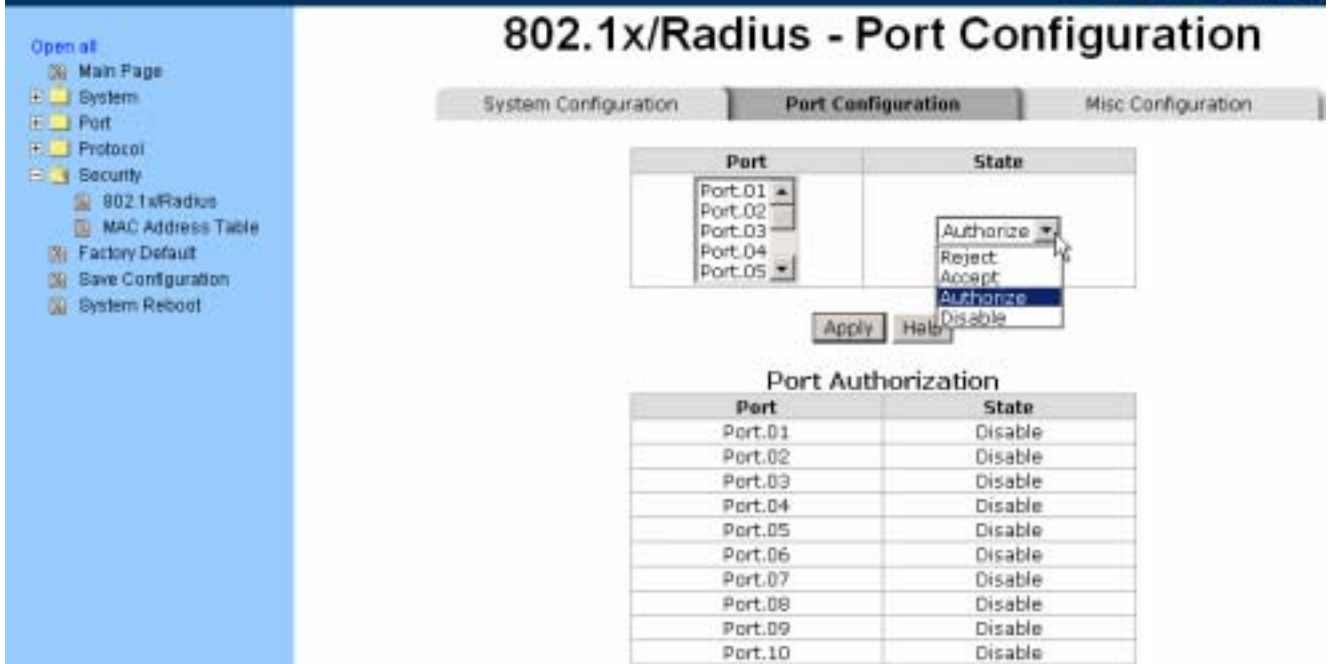

Figure 3.50: 802.1x/RADIUS - Port Setting interface

### 802.1X/RADIUS—Misc Configuration

- **Quiet Period:** Set the period which the port doesn't try to acquire a supplicant.
- **TX Period:** Set the period the port waits for retransmit next EAPOL PDU during an authentication session.
- **Supplicant Timeout:** Set the period of time the switch waits for a supplicant response to an EAP request.
- **Server Timeout:** Set the period of time the switch waits for a server response to an authentication request.
- **Max Requests:** Set the number of authentication that must time-out before authentication fails and the authentication session ends.
- **Reauth period:** Set the period of time which clients connected must be re-authenticated.
- Click  .

## 802.1x/RADIUS - Misc Configuration

System Configuration
Port Configuration
Misc Configuration

Quiet Period	60
Tx Period	30
Supplicant Timeout	30
Server Timeout	30
Max Requests	2
Reauth Period	3000

Figure 3.51: 802.1x/RADIUS - Misc Configuration interface



## MAC Address Table

Use the MAC address table to ensure the port security.

You can add a static MAC address; it remains in the switch's address table, regardless of whether the device is physically connected to the switch. This saves the switch from having to re-learn a device's MAC address when the disconnected or powered-off device is active on the network again. You can add / modify / delete a static MAC address.

### MAC Address Table—Static MAC Address

You can add static MAC address in the switch MAC table here.

- **MAC Address:** Enter the MAC address of the port that should permanently forward traffic, regardless of the device network activity.
- **Port No.:** Pull down the selection menu to select the port number.
- Click .
- If you want to delete the MAC address from filtering table, select the MAC address and click .

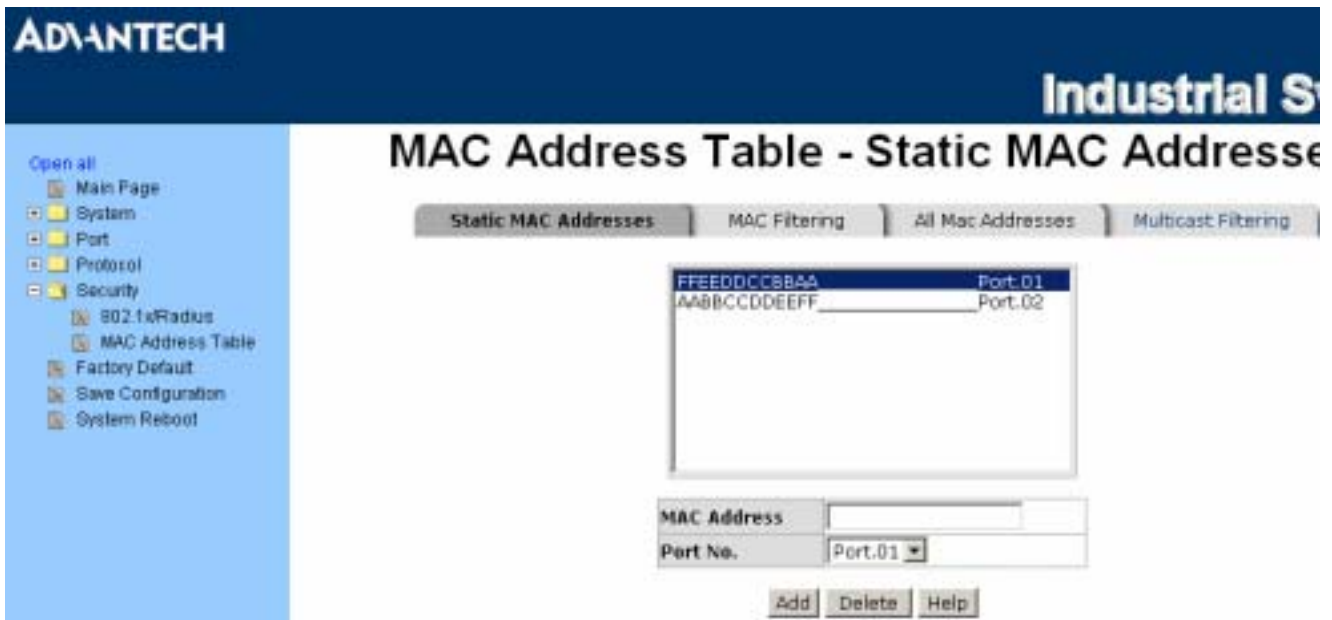

Figure 3.52: Static MAC Addresses interface

### MAC Address Table—MAC Filtering

By filtering MAC address, the switch can easily filter the pre-configured MAC address and reduce the unsafety. You can add and delete filtering MAC address.



Figure 3.53: MAC Filtering interface

- **MAC Address:** Enter the MAC address that you want to filter.
- Click **Add**.
- If you want to delete the MAC address from filtering table, select the MAC address and click **Delete**.

#### MAC Address Table—All MAC Addresses

You can view the port that connected device's MAC address and the related devices' MAC address.

- Select the port.
- The selected port of static & dynamic MAC address information will be displayed in here.
- Click **Clear MAC Table** to clear the current port static MAC address information on screen.



Figure 3.54: All MAC Address interface

## MAC Address Table—Multicast Filtering

Multicasts are similar to broadcasts, they are sent to all end stations on a LAN or VLAN. Multicast filtering is the system by which end stations only receive multicast traffic if they register to join specific multicast groups. With multicast filtering, network devices only forward multicast traffic to the ports that are connected to registered end stations.

- **IP Address:** Assign a multicast group IP address in the range of 224.0.0.0 ~ 239.255.255.255.
- **Member Ports:** Tick the check box beside the port number to include them as the member ports in the specific multicast group IP address.
- Click **Clear MAC Table** to clear the current port static MAC address information on screen.

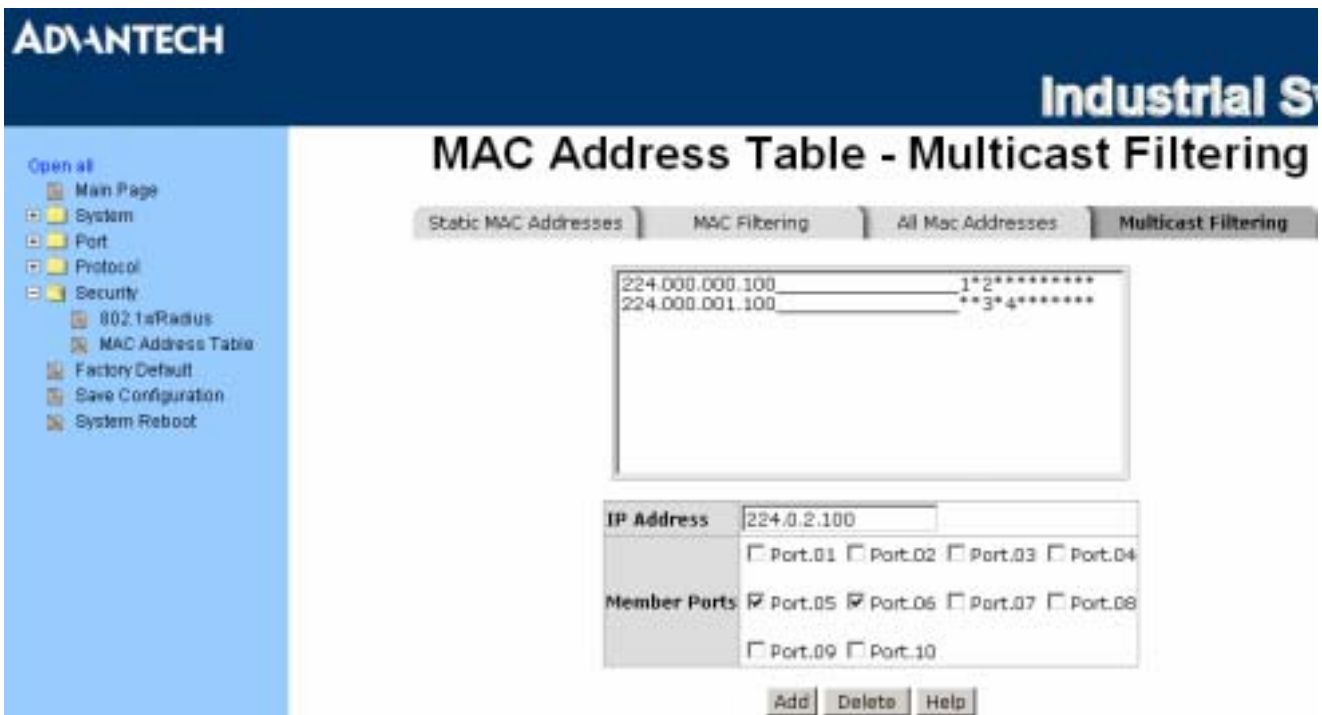

Figure 3.55: All MAC Address interface

## Factory Default

Reset switch to default configuration. Click **Reset** to reset all configurations to the default value.



Figure 3.56: Factory Default interface

## Save Configuration

Save all configurations that you have made in the system. To ensure the all configuration will be saved, click  to save the all configuration to the flash memory.



Figure 3.57: Save Configuration interface

## System Reboot

Reboot the switch in software reset. Click **Reboot** to reboot the system.



Figure 3.58: System Reboot interface

CHAPTER  
**4**

**Troubleshooting**

## Chapter 4 Troubleshooting

Verify that you are using the right power cord/adaptor (+12 ~ 48V<sub>DC</sub>), please don't use the power adaptor with DC output voltage higher than 48 V, or it will burn this converter down.

Select the proper UTP cable to construct the user network. Use unshielded twisted-pair (UTP) or shield twisted-pair (STP) cable for RJ-45 connections: 100 Category 3, 4 or 5 cable for 10Mbps connections, 100 Category 5 cable for 100Mbps connections, or 100 Category 5e/above cable for 1000Mbps connections. Also be sure that the length of any twisted-pair connection does not exceed 100 meters (328 feet).

### Diagnosing LED Indicators

To assist in identifying problems, the switch can be easily monitored through panel indicators, which describe common problems the user may encounter and where the user can find possible solutions.

If the power indicator does not light on when the power cord is plugged in, you may have a problem with power cord. Then check for loose power connections, power losses or surges at power outlet. If you still cannot resolve the problem, contact the local dealer for assistance.

If the LED indicators are normal and the connected cables are correct but the packets still cannot be transmitted. Please check the user system's Ethernet devices' configuration or status.



**APPENDIX  
A**

**Pin Assignment &  
Wiring**

# Appendix A Pin Assignment & Wiring

It is suggested to adopt ELA/TIA as the wiring of the RJ-45.

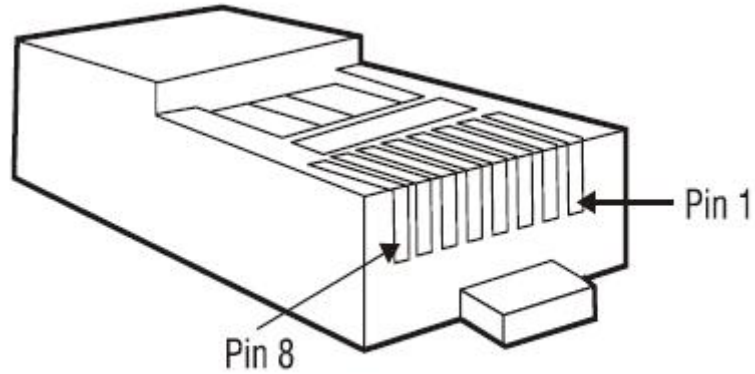

Figure A.1: RJ-45 Pin Assignment

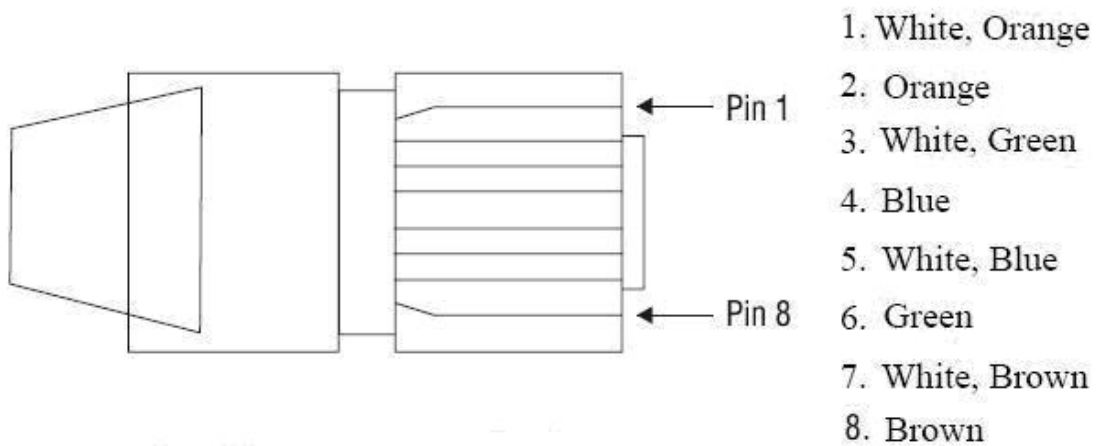

Figure A.2: EIA/TIA-568B

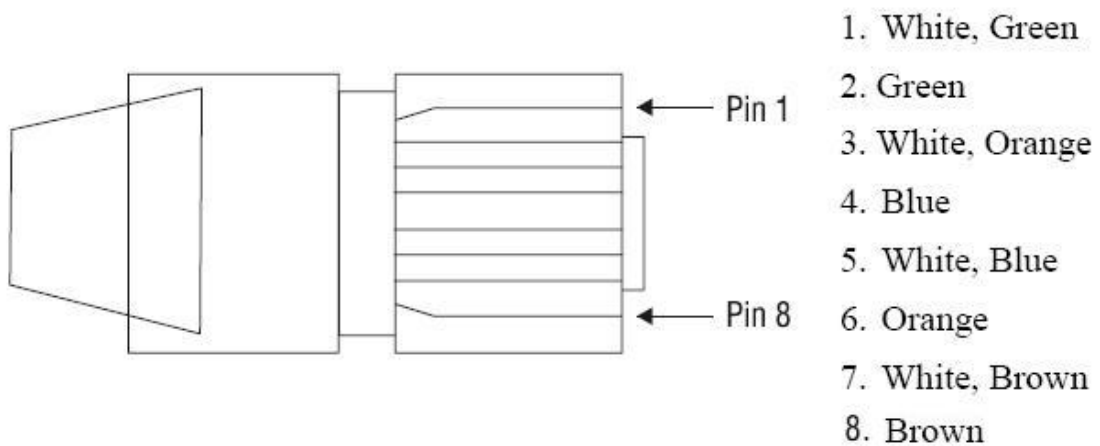
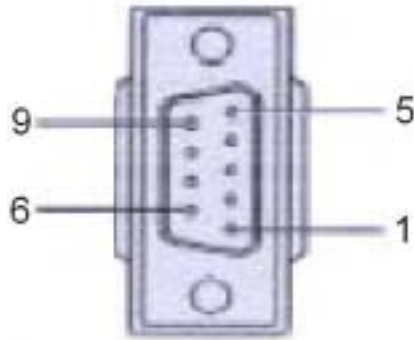

Figure A.3: EIA/TIA-568A



DB 9-pin Female

Figure A.4: DB 9-pin female connector

DB9 Connector	RJ-45 Connector
NC	1 Orange/White
2	2 Orange
3	3 Green/White
NC	4 Blue
5	5 Blue/White
NC	6 Green
NC	7 Brown/White
NC	8 Brown



APPENDIX  
**B**

**Compatible SFP  
Modules**

## Appendix B Compatible SFP Modules

The table below shows compatible SFP modules for EKI-7758F.

Item	Brand	Part Number	Mode	Transmission Distance
1	AVAGO	AFBR-5710PZ	Multi-mode	550m
2	APAC	LM28-C3S-TC-N		550m
3	HOATECH	HTI8512-X5ATO		550m
4	SPACE SHUTTLE	S56L-S85-6L-N		550m
5	LuminentOIC	SP-GB-LX	Single-mode	10km
		SP-GB-ELX		20km
		SP-GB-XD		50km
6	AVAGO	AFCT-5710PZ		10km
7	APAC	LS38-C3M-TC-N		20km
8	SPACE SHUTTLE	S56L-L13-6L-N		10km