

User Manual

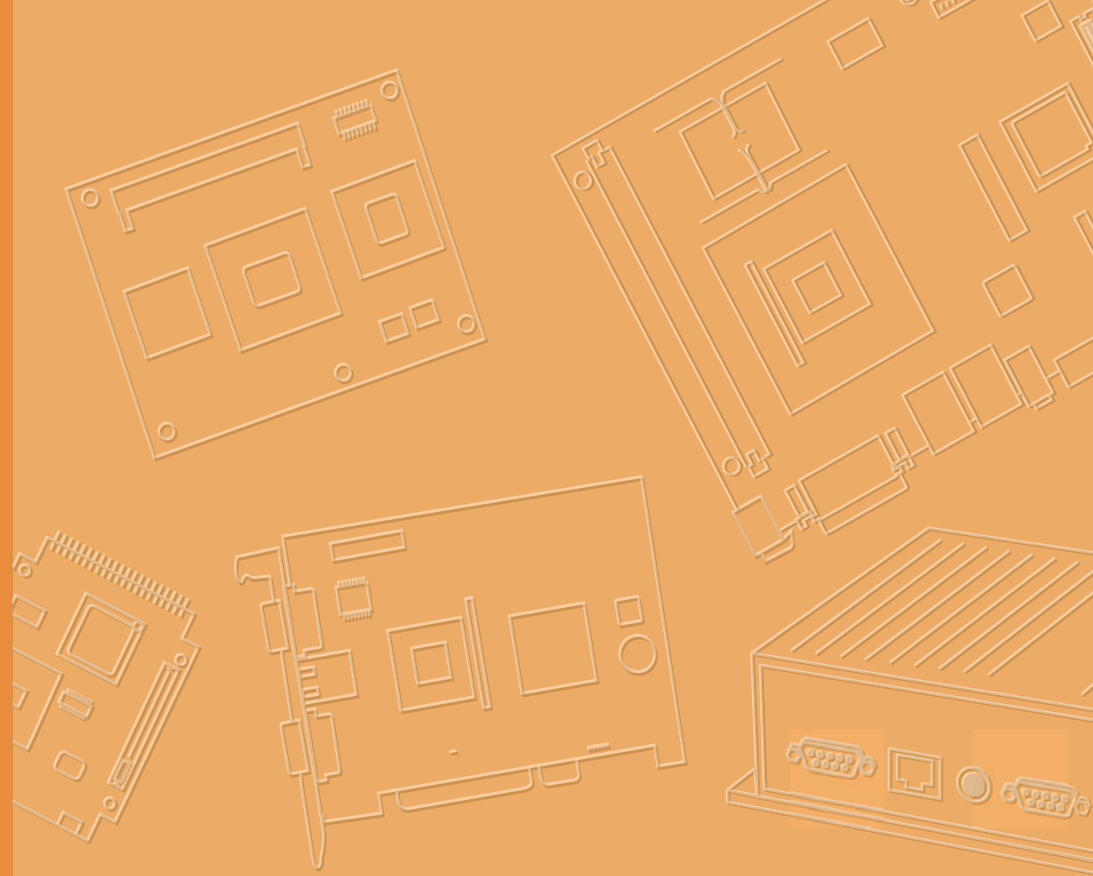

UTC-520

**Intel® Atom™ D510 Processor-
based Ubiquitous Touch
Computer with 21.5"LED**

Trusted ePlatform Services

ADVANTECH

Copyright

The documentation and the software included with this product are copyrighted 2010 by Advantech Co., Ltd. All rights are reserved. Advantech Co., Ltd. reserves the right to make improvements in the products described in this manual at any time without notice. No part of this manual may be reproduced, copied, translated or transmitted in any form or by any means without the prior written permission of Advantech Co., Ltd. Information provided in this manual is intended to be accurate and reliable. However, Advantech Co., Ltd. assumes no responsibility for its use, nor for any infringements of the rights of third parties, which may result from its use.

Acknowledgements

Award is a trademark of Award Software International, Inc. Intel and Celeron are trademarks of Intel Corporation.

IBM, PC/AT, PS/2 and VGA are trademarks of International Business Machines Corporation.

Intel and Pentium are trademarks of Intel Corporation.

Microsoft Windows is a registered trademark of Microsoft Corp. RTL is a trademark of Realtek Semiconductor Co., Ltd.

All other product names or trademarks are properties of their respective owners.

For more information on this and other Advantech products, please visit our websites at:

<http://www.advantech.com>

<http://www.advantech.com/ppc>

For technical support and service, please visit our support website at:

<http://support.advantech.com>

This manual is for the UTC-520.

Declaration of Conformity

FCC Class A

Note: This equipment has been tested and found to comply with the limits for a Class B digital device, pursuant to part 15 of the FCC Rules. These limits are designed to provide reasonable protection against harmful interference in a residential installation. This equipment generates, uses and can radiate radio frequency energy and, if not installed and used in accordance with the instructions, may cause harmful interference to radio communications. However, there is no guarantee that interference will not occur in a particular installation. If this equipment does cause harmful interference to radio or television reception, which can be determined by turning the equipment off and on, the user is encouraged to try to correct the interference by one or more of the following measures:

- Reorient or relocate the receiving antenna.
- Increase the separation between the equipment and receiver.
- Connect the equipment into an outlet on a circuit different from that to which the receiver is connected.
- Consult the dealer or an experienced radio/TV technician for help.

Warning! *Any changes or modifications made to the equipment which are not expressly approved by the relevant standards authority could void your authority to operate the equipment.*



Packing List

Before you begin installing UTC-520, please make sure that the following materials have been shipped:

- UTC-520 series
- Accessories for UTC-520
 - Warranty card
 - DC 12V/ 60W power Adapter
 - Driver CD-ROM disc
 - Mounting kits and packet of screws

If any of these items are missing or damaged, contact your distributor or sales representative immediately.

Technical Support and Assistance

1. Visit the Advantech web site at <http://support.advantech.com> where you can find the latest information about the product.
2. Contact your distributor, sales representative, or Advantech's customer service center for technical support if you need additional assistance. Please have the following information ready before you call:
 - Product name and serial number
 - Description of your peripheral attachments
 - Description of your software (operating system, version, application software, etc.)
 - A complete description of the problem
 - The exact wording of any error messages

Warning! *Danger of explosion if battery is incorrectly replaced. Replace only with the same or equiv- alent type recommended by the manufacturer. Dis- pose of used batteries according to the man- ufacturer's instructions.*



- Warning!**
1. *Input voltage rated 12 V, 5 A*
 2. *Use a 3 V @ 195 mA lithium battery*
 3. *Packing: please carry the unit with both hands, handle with care*
 4. *Maintenance: to properly maintain and clean the surfaces, use only approved products or clean with a dry applicator*
 5. *CompactFlash: Turn off power before insert- ing or removing Com- pactFlash storage card.*



Contact information:

Our European representative: Advantech Europe GmbH Kolberger StraÙe 7

D-40599 Dßsseldorf, Germany

Tel: 49-211-97477350

Fax: 49-211-97477300

Safety Instructions

1. Read these safety instructions carefully.
2. Keep this User Manual for later reference.
3. Disconnect this equipment from any AC outlet before cleaning. Use a damp cloth. Do not use liquid or spray detergents for cleaning.
4. For plug-in equipment, the power outlet socket must be located near the equipment and must be easily accessible.
5. Keep this equipment away from humidity.
6. Put this equipment on a reliable surface during installation. Dropping it or letting it fall may cause damage.
7. The openings on the enclosure are for air convection. Protect the equipment from overheating. **DO NOT COVER THE OPENINGS.**
8. Make sure the voltage of the power source is correct before connecting the equipment to the power outlet.
9. Position the power cord so that people cannot step on it. Do not place anything over the power cord.
10. All cautions and warnings on the equipment should be noted.
11. If the equipment is not used for a long time, disconnect it from the power source to avoid damage by transient overvoltage.
12. Never pour any liquid into an opening. This may cause fire or electrical shock.
13. Never open the equipment. For safety reasons, the equipment should be opened only by qualified service personnel.
14. If one of the following situations arises, get the equipment checked by service personnel:
 15. The power cord or plug is damaged.
 16. Liquid has penetrated into the equipment.
 17. The equipment has been exposed to moisture.
 18. The equipment does not work well, or you cannot get it to work according to the user's manual.
 19. The equipment has been dropped and damaged.
 20. The equipment has obvious signs of breakage.
21. **DO NOT LEAVE THIS EQUIPMENT IN AN ENVIRONMENT WHERE THE STORAGE TEMPERATURE MAY GO BELOW -20° C (-4° F) OR ABOVE 60° C (140° F). THIS COULD DAMAGE THE EQUIPMENT. THE EQUIPMENT SHOULD BE IN A CONTROLLED ENVIRONMENT.**
22. **CAUTION: DANGER OF EXPLOSION IF BATTERY IS INCORRECTLY REPLACED. REPLACE ONLY WITH THE SAME OR EQUIVALENT TYPE RECOMMENDED BY THE MANUFACTURER, DISCARD USED BATTERIES ACCORDING TO THE MANUFACTURER'S INSTRUCTIONS.**
23. The sound pressure level at the operator's position according to IEC 704-1:1982 is no more than 70 dB (A).

DISCLAIMER: This set of instructions is given according to IEC 704-1. Advantech disclaims all responsibility for the accuracy of any statements contained herein.

Contents

Chapter 1	General Information	1
1.1	Introduction	2
1.2	General Specifications	2
1.2.1	General	2
1.2.2	Standard PC functions	2
1.2.3	VGA Interface	2
1.2.4	Audio function	3
1.2.5	LAN Function	3
1.2.6	Touch screen (Optional)	3
1.2.7	Optional modules	3
1.2.8	Environment	4
1.3	LCD Specifications	4
1.4	Dimensions	5
	Figure 1.1 Dimensions of UTC-520	5
Chapter 2	System Setup	7
2.1	A Quick Tour of the UTC-520	8
	Figure 2.1 Front view of UTC-520	8
	Figure 2.2 Rear view of UTC-520	8
2.2	Installation Procedures	9
2.2.1	Connecting the power cord	9
2.2.2	Connecting the keyboard or mouse	9
2.2.3	Switching on the power	9
	Figure 2.3 Connect the power cord to the DC inlet	9
2.3	Running the BIOS Setup Program	10
2.4	Installing System Software	10
2.4.1	Method 1: Ethernet	10
2.4.2	Method 2: External USB CD-ROM	10
2.5	Installing the Drivers	11
Chapter 3	Hardware Installation and Upgrading	13
3.1	Introduction	14
3.2	Installing the 2.5" Hard Disk Drive (HDD)	14
	Figure 3.1 Installing primary 2.5" HDD	15
3.3	Installing the Compact Flash card	16
	Figure 3.2 Installing the Compact Flash card	16
3.4	Installing the Wireless LAN card	16
Chapter 4	Jumper Settings and Connectors	25
4.1	Jumpers and Connectors	26
4.1.1	Setting jumpers	26
4.1.2	Jumpers and connectors	27
	Table 4.1: Jumpers and Connector functions	27
4.1.3	Locating jumpers and connectors	28
	Figure 4.1 Jumpers and Connectors on the UTC-520 motherboard	28
4.2	Jumpers	29

4.2.1	Jumper list	29
	Table 4.2: Jumper List.....	29
4.2.2	Jumper Settings.....	29
	Table 4.3: J2: COM2 Setting	29
	Table 4.4: J3: AT / ATX Power SEL	29
	Table 4.5: J4: Clear COMS	30
	Table 4.6: J5: PAN VOL SEL	30

Appendix A I/O Pin Assignments 31

A.1	PIN Assignments	32
	Table A.1: CN1: Audio	32
	Table A.2: CN3: SATA	32
	Table A.3: CN4: GPIO	33
	Table A.4: CN5: HDD & PWR LED.....	33
	Table A.5: CN6: 12V AT Power Input.....	34
	Table A.6: CN17: COM2.....	35
	Table A.7: CN13: Inverter Power Output	35
	Table A.8: CN14: Internal USB.....	36
	Table A.9: CN15: Internal USB.....	36
	Table A.10:CN16: 18 bits LVDS Panel	37
	Table A.11:CN18: LAN1	38
	Table A.12:CN19: LAN2	38
	Table A.13:CN20: Power Switch (Low Active).....	38
	Table A.14:CN11: LPT.....	39
	Table A.15:CN22: Standby Power Input.....	39
	Table A.16:CN2: Reset.....	40
	Table A.17:CN24: External USB.....	40
	Table A.18:CN25: External USB.....	41
	Table A.19:CN26: COM1.....	41
	Table A.20:CN27: VGA.....	42
	Table A.21:CN28: Mini PCIE lock.....	42
	Table A.22:CN29: Mini PCIE slot.....	43
	Table A.23:CN30: DDR2 SODIMM.....	45
	Table A.24:CN31: BIOS Socket.....	50
	Table A.25:CN32: CF	50

Appendix B UTC-500 Peripherals Series Installation Guide 53

B.1	UTC-500 Peripherals Series Installation Guide	54
-----	---	----

Chapter 1

General Information

This chapter gives background information on the UTC-520.

Sections include:

- Introduction
- General Specifications
- LCD Specifications
- Dimensions

1.1 Introduction

The UTC-520 is an Intel low-power Intel® Atom™ D510 processor computer that is designed to serve as a interactive self-service terminal and as a multimedia computer. It is a PC-based system with 21.5" TFT LCD display, on-board PCIe Ethernet controller, one COM port and A VGA connector. With a built in internal IDE connector (for CF card), one SATA connector for HDD and an mini PCIe expansion socket, the UTC-520 is a compact and user-friendly multi-function computer. In addition, its “fit anywhere” design makes it very flexible and able to be used in many different kinds of installations. It can be wall mounted or stood upright on a desktop.

For system integrators, this simple, complete, compact and highly integrated multimedia system lets you easily build UTC-520 into your applications. Common industrial applications include self-transaction & healthcare, information kiosk & interactive signage. UTC-520 is a reliable, cost-effective solution for your application requirements.

1.2 General Specifications

1.2.1 General

- **Dimensions (W x H x D):** 516 x 313 x 40 mm
- **Weight:** 6 kg
- **Power supply:** ATX type Input Voltage: +12 V_{DC}, 5A
- **Power adaptor:** AC/DC (Standard Build in)
Input voltage: 100 ~ 240 V_{AC}
Output voltage: 12 V @ 5 A
- **Disk drive housing:** Space for one 2.5" SATA HDD
- **Front panel:** IP54/NEMA4 compliant

1.2.2 Standard PC functions

- **CPU:** Onboard Intel® Atom™ D510 1.6 GHz with 512KB x 2 L2 cache
- **BIOS:** AMI 16 Mbit flash BIOS
- **System chipset:** Intel® Atom™ D510 + Intel ICH8M
- **2nd level cache:** 512 KB x 2
- **System memory:** One 200-pin SO-DIMM socket, accepting up to 2GB DDR2 667 (doesn't support DDR2 533MHz Memory) Function
- **Serial ports:** 1* external COM
- **Universal serial bus (USB) port:** Supports up to 2 USB V2.0
- **Mini PCI-E bus expansion slot:** Accepts one mini PCI-E device(Wire less LAN card)
- **Solid State Disk:** Supports CompactFlash card type I/II (True IDE mode)
- **Watchdog timer:** Single chip Watchdog 255-level interval timer, setup by software
- **Power management:** Full ACPI (Advanced Configuration and Power Interface) 2.0 Supports S0, S1, S3, S4, S5

1.2.3 VGA Interface

- **Chipset:** The GPU Contains a refresh of the third generation graphics core
- **Memory Size:** Up to 224 MB of dynamic video memory allocation
- **Interface:** VGA
- **Display mode:**
 - CRT: Analog RGB display output resolution up to 2048*1536 @ 60 Hz

1.2.4 Audio function

- **Audio:** High Definition Audio (HD), 3 W x 2 Speakers

1.2.5 LAN Function

- **Chipset:** LAN1 Intel 82567, LAN2 Intel 82583V
- **Speed:** 1000 Mbps /Interface: 2 x RJ45
- **Wake-on-LAN:** Supports Wake-on-LAN function with ATX power control
- Supports LAN teaming (in Fault Tolerance)

1.2.6 Touch screen (Optional)

Type	Analog Resistive 5 wires
Resolution	Continuous
Light Transmission	80%
Controller	USB interface
Power Consumption	<5 V @ 60 mA
Software Driver	Supports Windows XP/ 7/ XPE
Durability(touches in a lifetime)	36 million

1.2.7 Optional modules

- **Memory:** One 200-pin SO-DIMM socket, accepting up to 2 GB DDR2 667
- **HDD:** 2.5" SATA HDD
- **SSD:** Supports CompactFlash® Card TYPE I/II
- **Operating System:** Windows XP, Vista, 7
- **Touchscreen:** Analog resistive (UTC-520-RE)
- **Power cord:** 1702002600 (US) 1702002605 (Europe)
- **Wireless LAN Module:**
968EMW0038 Wireless IEEE 802.11 b/g/n AW-NE785 PCIE
1750006010 (Cable),
9680001060 (Antenna)

Peripherals for UTC-500 series

- UTC-P01-A0E (2M Wecam)
- UTC-P02-A0E (MSR)
- UTC-P03-A0E (RFID)
- UTC-P06-A0E (Smart Card Reader)

Standard Floor Stand Kits

- UTC-K01-STANDE
- UTC-K02-STANDE
- UTC-R01-STANDE
- UTC-S01-STANDE

1.2.8 Environment

- **Operating temperature:** 0 ~ 40° C (32 ~ 104° F)
- **Storage temperature:** -20 ~ 60° C
- **Relative humidity:** 10 ~ 95% @ 40° C (non-condensing)
- **Shock:** 10 G peak acceleration (11 ms duration)
- **Certification:** EMC: CE, FCC, BSMI, VCCI.
Safety: UL 60950, CB, CCC, BSMI
- **Vibration:** 5 ~ 500 Hz 0.5 G RMS Random vibration
- **VESA Support:** 100 x 100 mm (Suggest screws type- M4 x 5)
- Supports landscape and portrait screen mode

1.3 LCD Specifications

- **Display type:** 21.5" TFT LCD
- **Max. resolution:** 1366 x 768 (Default setting is 1366 x768m, scalar board allows resolution up to Full HD)
- **Colors:** 16.7 M
- **Dot size (mm):** 248.25(H) X 248.25 (V)
- **Viewing angle:** 170 ° / 160°
- **Luminance:** 400 cd/m²
- ***VR control:** Brightness could be modified through BIOS

Note! *The color LCD display installed in the UTC-520 is high-quality and reliable. However, it may contain a few defective pixels which do not always illuminate. With current technology, it is impossible to completely eliminate defective pixels. Advantech is actively working to improve this technology.*



1.4 Dimensions

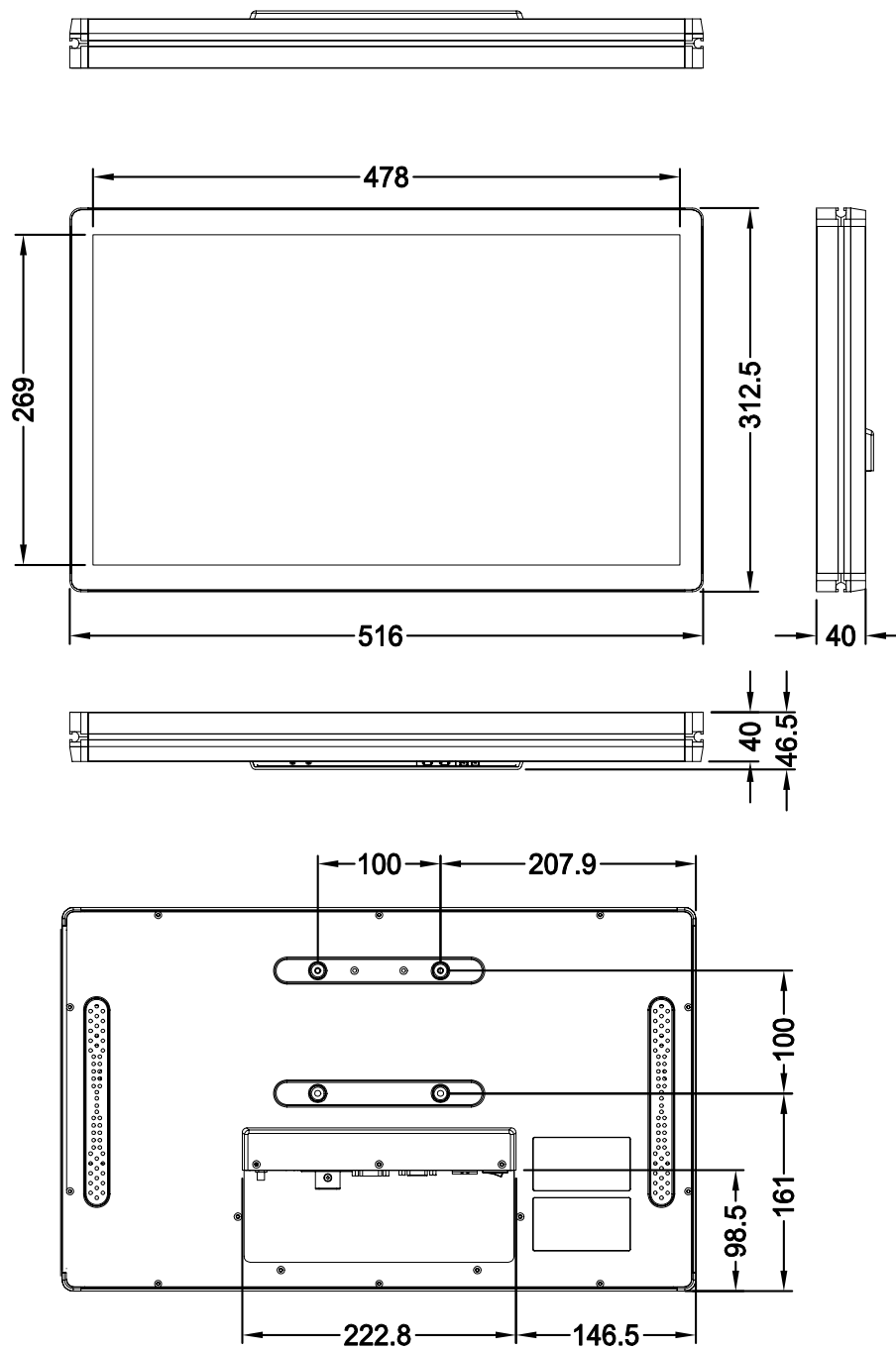

Figure 1.1 Dimensions of UTC-520

Chapter 2

System Setup

This chapter details system setup on the UTC-520.

Sections include:

- A Quick Tour of the UTC-520
- Installation procedures
- Running the BIOS Setup Program
- Installing System Software

2.1 A Quick Tour of the UTC-520

Before you start to set up the UTC-520, take a moment to become familiar with the locations and purposes of the controls, drives, connectors and ports, which are illustrated in the figures below.

When you place the UTC-520 upright on the desktop, its front panel appears as shown in Figure 2.1.

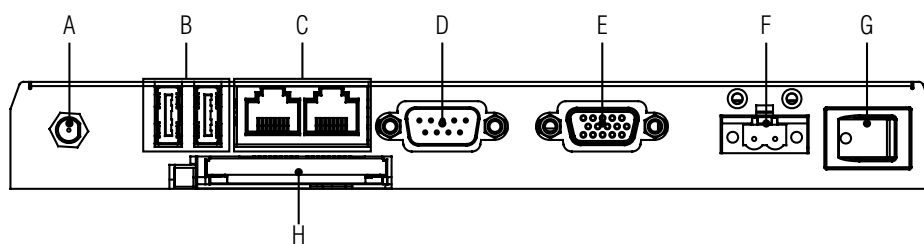

Figure 2.1 Front view of UTC-520

When you turn the UTC-520 around and look at its rear cover, you will find the I/O section as shown in Fig. 2.2. (The I/O section includes various I/O ports, including serial ports, Ethernet ports, USB ports, the VGA, and Compact Flash slot so on.) The Compact Flash slot is at the bottom of the UTC-520.



Figure 2.2 Rear view of UTC-520



A. Antenna connector
 B. USB 2.0 x 2
 C. Gigabit LAN x 2
 D. COM port

E. VGA
 F. DC Inlet
 G. Power Switch
 H. Compact Flash slot

2.2 Installation Procedures

2.2.1 Connecting the power cord

The UTC-520 can be powered by a DC electrical outlet. Be sure to always handle the power cords by holding the plug ends only. Please follow the Figure 2.5 to connect the male plug of the power cord to the DC inlet of the UTC-520.

Warning! Failure to plug the green power adapter jack into the UTC-520 first, BEFORE turning on power will result in damage to the motherboard.



2.2.2 Connecting the keyboard or mouse

Before you start the computer, please connect keyboard port on the I/O section of the UTC-520.

2.2.3 Switching on the power

When you look at the rear side of the UTC-520, you will see the power switch as shown in Figure 2.2.



Figure 2.3 Connect the power cord to the DC inlet

2.3 Running the BIOS Setup Program

Your UTC-520 is likely to have been properly set up and configured by your dealer prior to delivery. You may still find it necessary to use the UTC-520's BIOS (Basic Input-Output System) setup program to change system configuration information, such as the current date and time or your type of hard drive. The setup program is stored in read-only memory (ROM). It can be accessed either when you turn on or reset the UTC-520, by pressing the "Del" key on your keyboard immediately after powering on the computer.

The settings you specify with the setup program are recorded in a special area of memory called CMOS RAM. This memory is backed up by a battery so that it will not be erased when you turn off or reset the system. Whenever you turn on the power, the system reads the settings stored in CMOS RAM and compares them to the equipment check conducted during the power on self-test (POST). If an error occurs, an error message will be displayed on screen, and you will be prompted to run the setup program.

2.4 Installing System Software

Recent releases of operating systems from major vendors include setup programs which load automatically and guide you through hard disk preparation and operating system installation. The guidelines below will help you determine the steps necessary to install your operating system on the UTC-520 hard drive.

Note! *Some distributors and system integrators may have already pre-installed system software prior to shipment of your UTC-520.*



Installing software requires an installed HDD. Software can be loaded in the UTC-520 using any of four methods:

2.4.1 Method 1: Ethernet

You can use the Ethernet port to download software to the HDD.

2.4.2 Method 2: External USB CD-ROM

If required, insert your operating system's installation or setup diskette into the diskette drive until the release button pops out.

The BIOS of UTC-520 supports system boot-up directly from the CD-ROM drive. You may also insert your system installation CD-ROM into the CD-ROM drive.

Power on your UTC-520 or reset the system by pressing the "Ctrl+Alt+Del" keys simultaneously. The UTC-520 will automatically load the operating system from the diskette or CD-ROM.

If you are presented with the opening screen of a setup or installation program, follow the instructions on screen. The setup program will guide you through preparation of your hard drive, and installation of the operating system. If you are presented with an operating system command prompt, such as A:\>, then you must partition and format your hard drive, and manually copy the operating system files to it. Refer to your operating system user manual for instructions on partitioning and formatting a hard drive.

2.5 Installing the Drivers

After installing your system software, you will be able to set up the Ethernet, XGA, audio, and touchscreen functions. All drivers are stored in a CD-ROM disc entitled "Drivers and Utilities" which can be found in your accessory box.

The various drivers and utilities in the CD-ROM disc have their own text files which helps users install the drivers and understand their functions. These files are a very useful supplement to the information in this manual.

Note! *The drivers and utilities used for the UTC-520 are subject to change without notice.*



If in doubt, check Advantech's website or contact our application engineers for the latest information regarding drivers and utilities.

Chapter 3

Hardware Installation and Upgrading

This chapter details installing the UTC-520 hardware.

Sections include:

- Overview of Hardware Installation and Upgrading
- Installing the 2.5" Hard Disk Drive (HDD)
- Installing the Compact Flash

3.1 Introduction

The UTC-520 consists of a PC-based computer that is housed in an Aluminum extrusion. You can install a HDD, DRAM, and Compact Flash by removing the rear cover. Any maintenance or hardware upgrades can be easily completed after removing the rear cover.

Warning! *Do not remove the rear cover until you have verified that no power is flowing within the UTC-520. Power must be switched off and the power cord must be unplugged. Every time you service the UTC-520, you should be aware of this.*



3.2 Installing the 2.5" Hard Disk Drive (HDD)

You can attach one Serial Advanced Technology Attachment (SATA) hard disk drive to the UTC-520's internal controller. The SATA controller supports faster data transfer and allows the SATA hard drive to exceed 150 MB. The following are instructions for installation:

1. Detach and remove the rear cover.
2. Place the HDD in the metal bracket, and tighten the screws (see Figure 3.1).
3. The HDD cable (SATA 7P+1*5P-2.5/SATA(15+7)P) is next to the metal brace. Connect the HDD cable to the motherboard (CN3/CN5). Plug the other end of the cable into the SATA hard drive.
4. Put the rear cover on and tighten the screws.

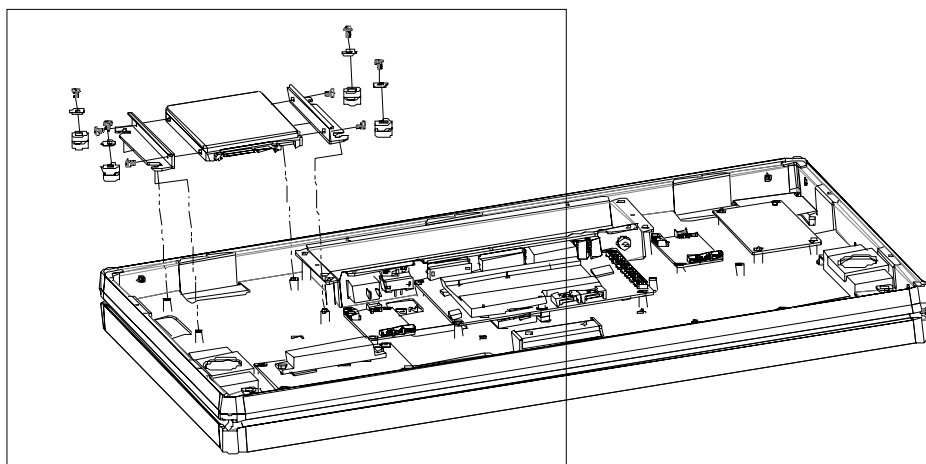
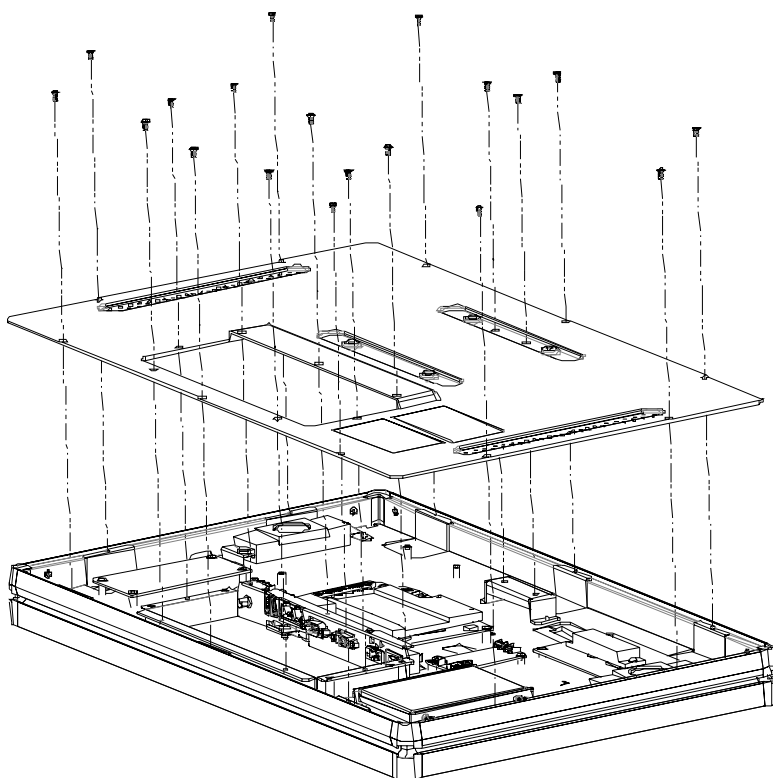

Figure 3.1 Installing primary 2.5" HDD

3.3 Installing the Compact Flash card

1. Please follow the Compact Flash card assembly as in the following diagram. (Please notice the direction of the CF Card)

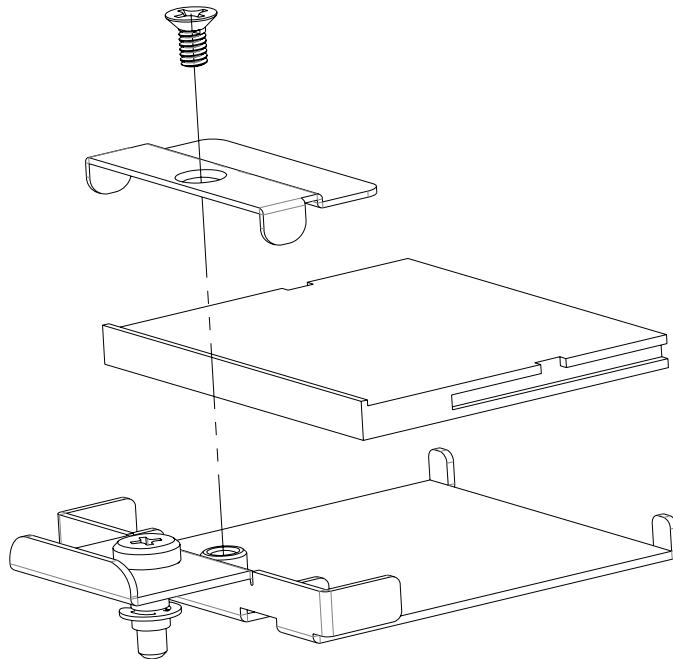

Figure 3.2 Installing the Compact Flash card

3.4 Installing the Wireless LAN card

1. Remove 19 pcs screws of back cover.



2. Remove connectors on M/B.

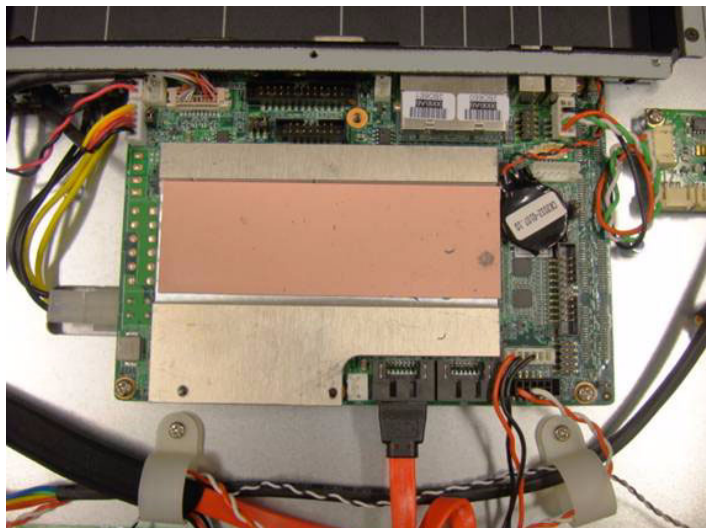

3. Remove 4 pcs screws on I/O bracket.

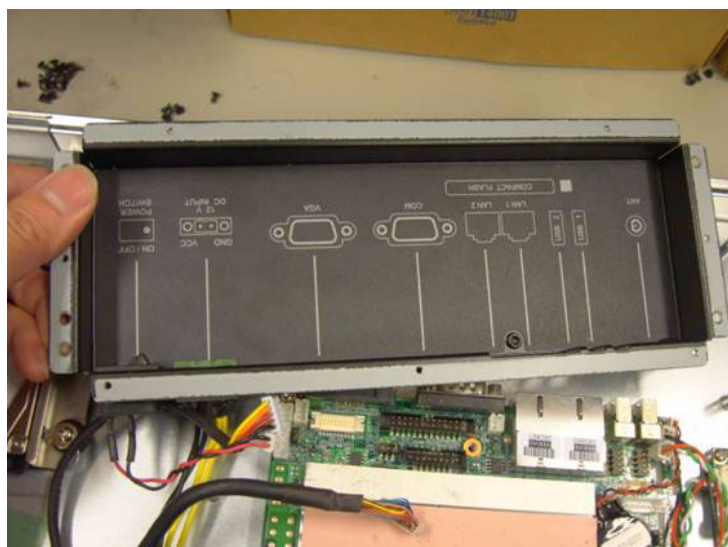
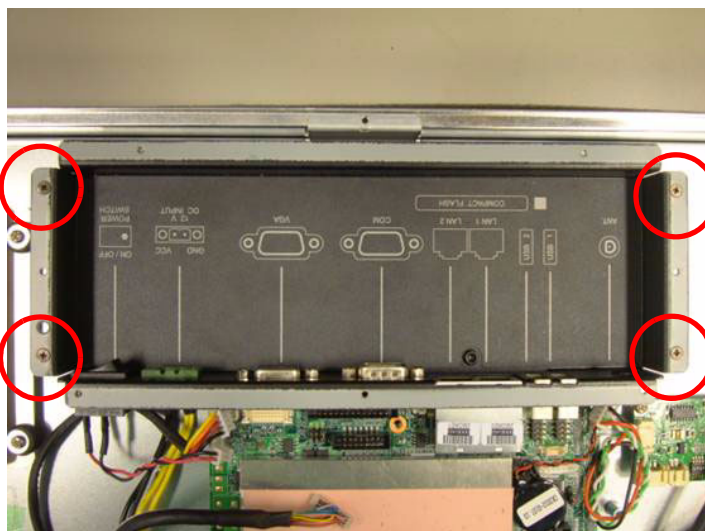

4. Remove 5 pcs screws on M/B.

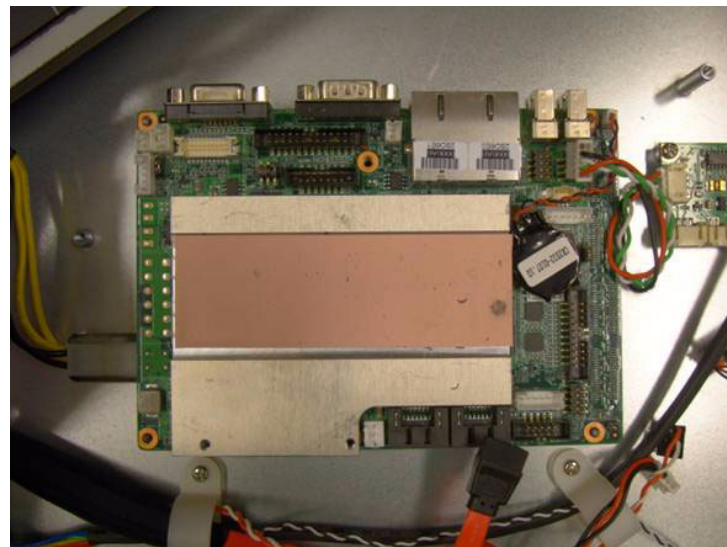
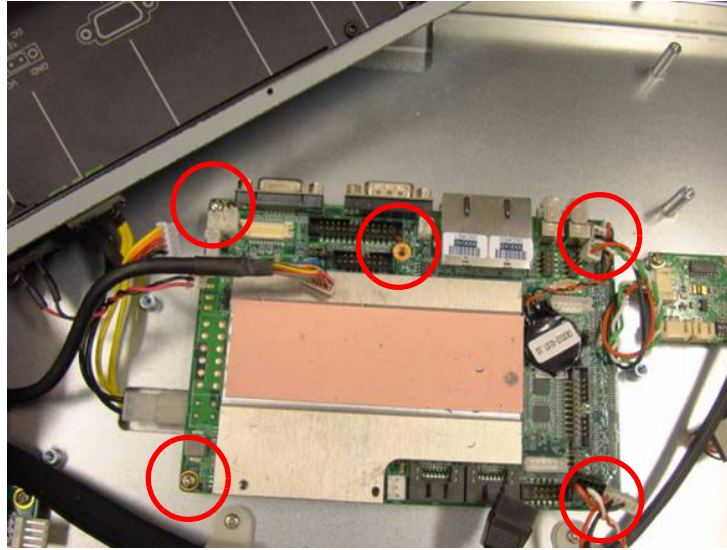

5. Take the M/B

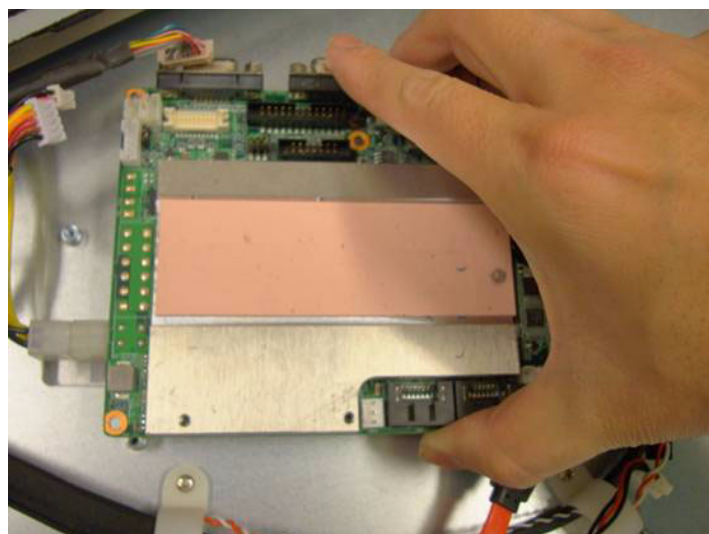

6. Remove the DC-in cable.

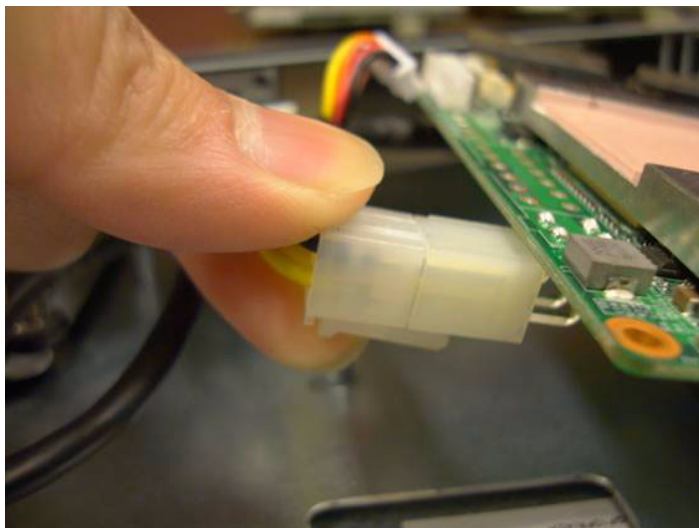

7. Install the WLAN card on M/B bottom side.

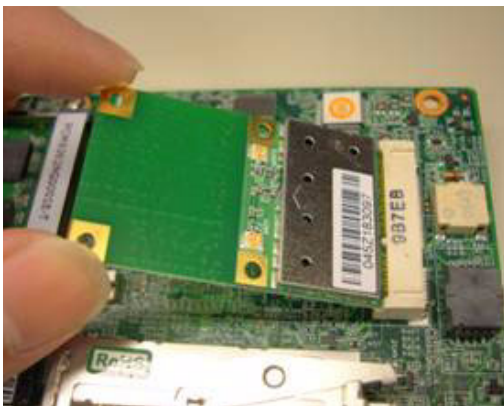

8. Remove the Antenna D-hole plug from I/O bracket.

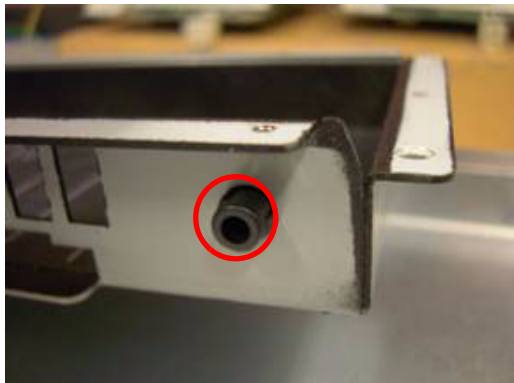
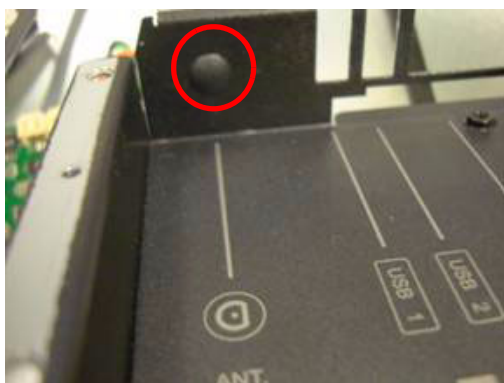

9. Coaxial cable.



10. Put the black rubber gasket in SMA side first.



11. Find out the smooth side of the circle.

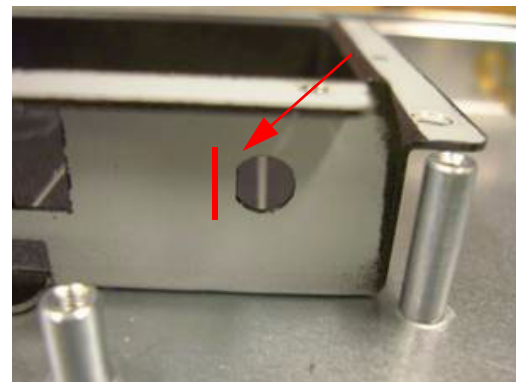
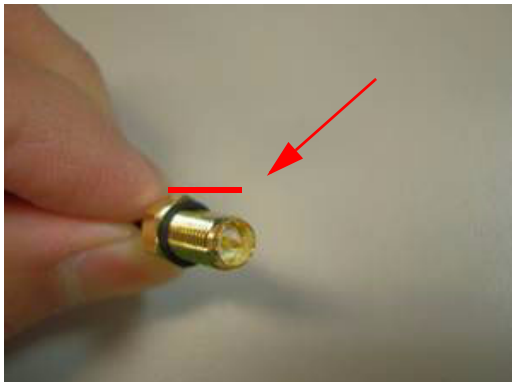

12. Install the cable into Antenna hole.

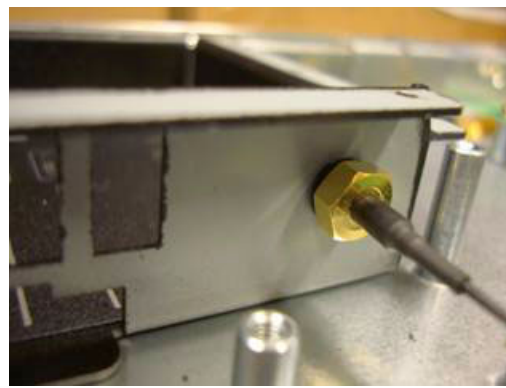
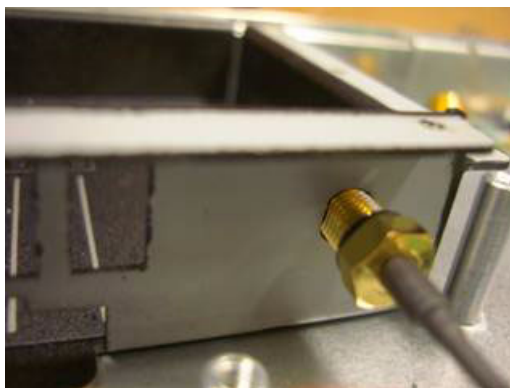

13. Install the Washer & Nut.

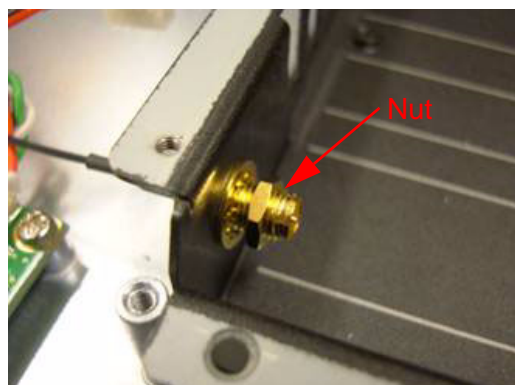
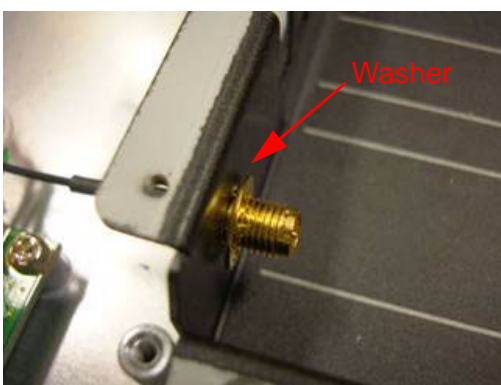

14. Connect the coaxial cable to "ANT1" on the WLAN card.



15. Put the M/B back and assembly back the 5 pcs screws on M/B.

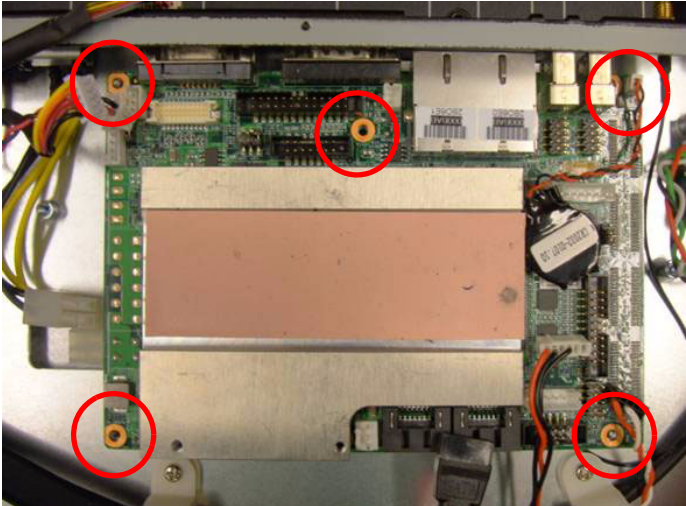

16. Put the I/O bracket back and assembly back the 4 pcs screws.

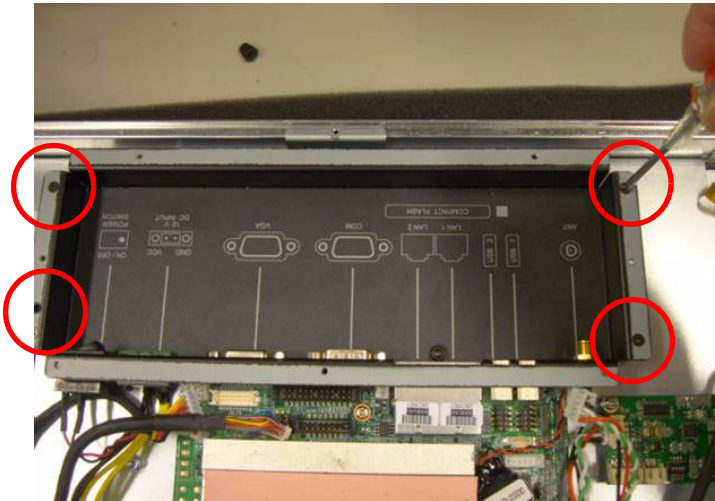

17. Assembly whole connectors back.

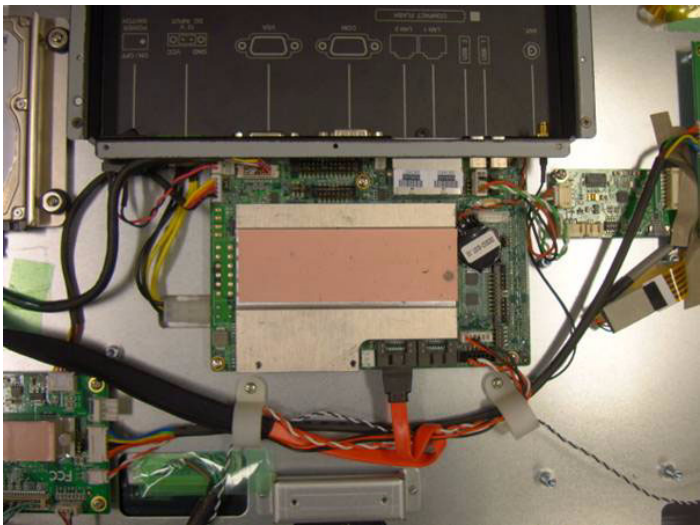

18. Assembly the 19 pcs screws on the back cover.



19. Assembly the Antenna.



20. Finished.

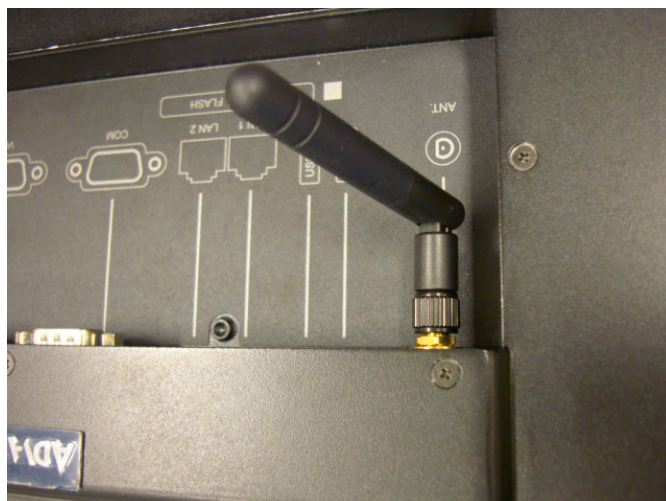

Chapter 4

Jumper Settings and Connectors

This chapter tells how to set up the UTC-520 hardware, including instructions on setting jumpers and connecting peripherals, switches and indicators. Be sure to read all the safety precautions before you begin the installation procedures.

Sections include:

- Jumpers and Connectors
- CMOS Clear for External RTC (J5)
- COM Port Interface
- VGA Interface
- Watchdog Timer Configuration

4.1 Jumpers and Connectors

4.1.1 Setting jumpers

You can configure your UTC-520 to match the needs of your application by setting jumpers. A jumper is the simplest kind of electrical switch. It consists of two metal pins and a small metal clip (often protected by a plastic cover) that slides over the pins to connect them. To 'close' a jumper, you connect the pins with the clip. To 'open' a jumper you remove the clip. Sometimes a jumper will have three pins, labeled 1, 2, and 3. In this case, you would connect either pins 1 and 2 or pins 2 and 3.

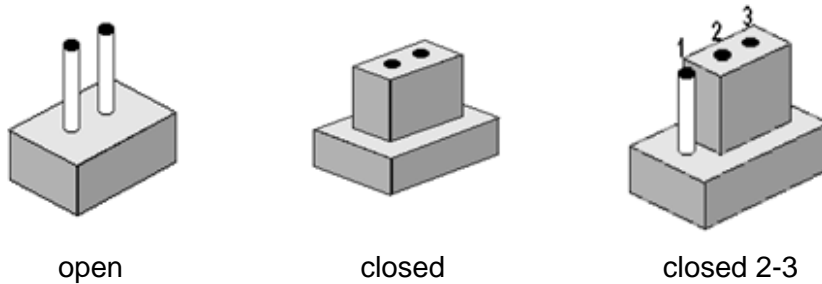

The jumper settings are schematically depicted in this manual as follows:.

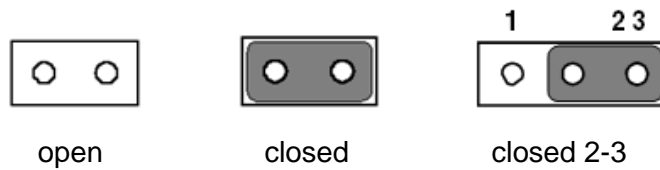

A pair of needle-nose pliers may be helpful when working with jumpers. If you have any doubts about the best hardware configuration for your application, contact your local distributor or sales representative before you make any changes.

4.1.2 Jumpers and connectors

The motherboard of the UTC-520 has a number of jumpers and connectors that allow you to configure your system to suit your applications. The table below lists the function of each of the board's jumpers.

Table 4.1: Jumpers and Connector functions

CN1	Audio
CN3	SATA (2.5" HDD)
CN4	GPIO
CN5	SATA HDD power connector (2.5" HDD)
CN6	12V Power Input
CN12	COM2
CN13	Inverter Power Output
CN14	Internal USB
CN15	Internal USB
CN16	18 bits LVDS Panel
CN18	LAN1
CN19	LAN2
CN20	Power Switch (Low Active)
CN22	Standby Power Input
CN23	Reset
CN24	External USB
CN25	External USB
CN26	COM1
CN27	VGA
CN28	Mini PCIE lock
CN30	DDR2 SODIMM
CN31	BIOS Socket
CN32	CF slot

4.1.3 Locating jumpers and connectors

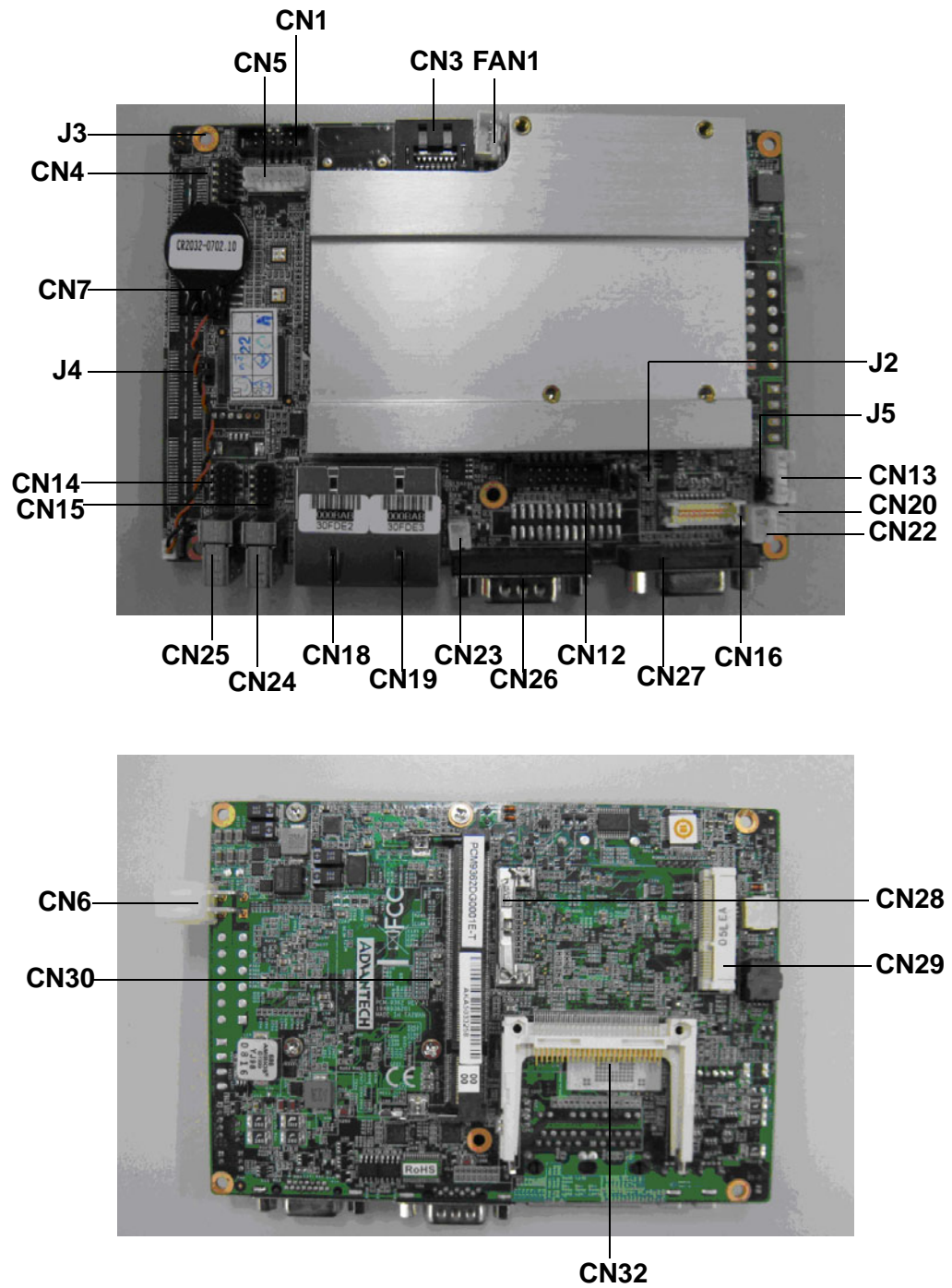

Figure 4.1 Jumpers and Connectors on the UTC-520 motherboard

4.2 Jumpers

4.2.1 Jumper list

Table 4.2: Jumper List

J2	COM2 Setting
J3	AT / ATX Power SEL
J4	Clear CMOS
J5	Panel Voltage SEL

4.2.2 Jumper Settings

Table 4.3: J2: COM2 Setting

Part Number	1653003260
Footprint	HD_3x2P_79
Description	PIN HEADER 3*2P 180D(M) 2.0mm SMD SQUARE PIN
Setting	Function
(1-2)	RS232
(3-4)	RS485
(5-6)	RS422

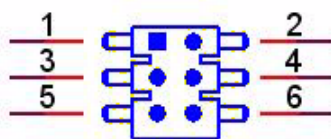

Table 4.4: J3: AT / ATX Power SEL

Part Number	1653002101
Footprint	HD_2x1P_79_D
Description	PIN HEADER 2*1P 180D(M)SQUARE 2.0mm DIP W/O Pb
Setting	Function
(1-2)	AT Power SEL
EMPTY	ATX Power

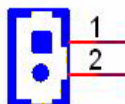

Table 4.5: J4: Clear COMS

Part Number	1653003101
Footprint	HD_3x1P_79_D
Description	PIN HEADER 3*1P 180D(M) 2.0mm DIP SQUARE W/O Pb
Setting	Function
(1-2)	Normal
(2-3)	Clear CMOS

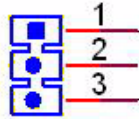
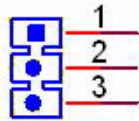

Table 4.6: J5: PAN VOL SEL

Part Number	1653003101
Footprint	HD_3x1P_79_D
Description	PIN HEADER 3*1P 180D(M) 2.0mm DIP SQUARE W/O Pb
Setting	Function
(1-2)	+5V
(2-3)	+3V



Appendix **A**

I/O Pin Assignments

A.1 PIN Assignments

Table A.1: CN1: Audio

Part Number	1653205260
Footprint	HD_5x2P_79_BOX
Description	BOX HEADER SMD 5*2 180D (M) 2.0mm
Pin	Pin Name
1	LOUTR
2	LINR
3	GND
4	GND
5	LOUTL
6	LINL
7	GND
8	GND
9	MIC1R
10	MIC1L

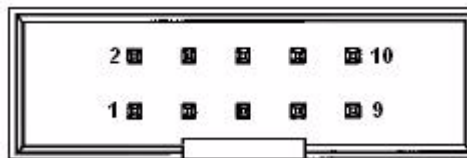

Matching Cable : 1703100152

Table A.2: CN3: SATA

Part Number	1654002320
Footprint	FOX_LD1107V-S33T5
Description	Serial ATA 7P 1.27 90D(M) SMD LD1107V-S33T5
Pin	Pin Name
1	GND
2	TX+
3	TX-
4	GND
5	RX-
6	RX+
7	GND

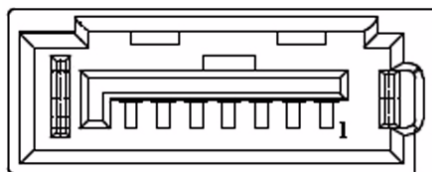
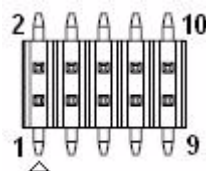

Table A.3: CN4: GPIO

Part Number	1653005261
Footprint	HD_5x2P_79
Description	PIN HEADER SMD 5*2P 180D(M) 2.0mm
Pin	Pin Name
1	+5V
2	GPIO4
3	GPIO0
4	GPIO5
5	GPIO1
6	GPIO6
7	GPIO2
8	GPIO7
9	GPIO3
10	GND

**Table A.4: CN5: HDD & PWR LED**

Part Number	1655306020
Footprint	WHL6V-2M
Description	WAFER BOX 2.0mm 6P 180D(M) W/LOCK
Pin	Pin Name
1	+5V
2	GND
3	Power LED+
4	Power LED-
5	HDD LED+
6	HDD LED-

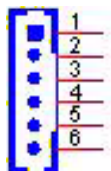

Table A.5: CN6: 12V AT Power Input

Part Number	1655404090
Footprint	ATXCON-2X2-42
Description	ATX PWR CONN. 2*2P 180D 4.2mm 24W4310-04S10-01T
Pin	Pin Name
1	GND
2	GND
3	+12V
4	+12V

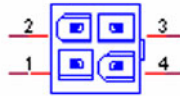
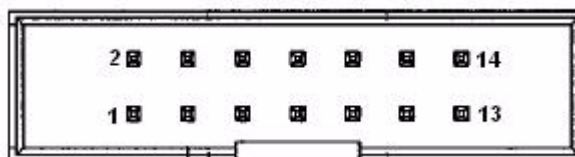

Table A.6: CN17: COM2

Part Number	1653207260
Footprint	HD_7x2P_79_BOX
Description	BOX HEADER SMD 7*2P 180D(M) 2.0mm
Pin	Pin Name
1	DCD#
2	DSR#
3	RXD
4	RTS#
5	TXD
6	CTS#
7	DTR#
8	RI#
9	GND
10	GND
11	422/485TX+
12	422/485TX-
13	422RX+
14	422RX-



Matching Cable : 1701140201

Table A.7: CN13: Inverter Power Output

Part Number	1655000453
Footprint	WHL5V-2M-24W1140
Description	WAFER BOX 2.0mm 5P 180D(M) DIP WO/pb JIH VEI
Pin	Pin Name
1	+12V
2	GND
3	ENABKL
4	VBR
5	+5V

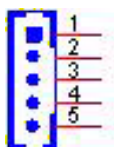
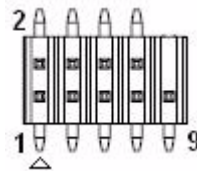

Table A.8: CN14: Internal USB

Part Number	1653005260
Footprint	HD_5x2P_79_N10
Description	PIN HEADER 2*5P 180D(M) 2.0mm SMD IDIOT-PROOF
Pin	Pin Name
1	+5V
2	+5V
3	A_D-
4	B_D-
5	A_D+
6	B_D+
7	GND
8	GND
9	GND



Matching Cable : 1703100121

Table A.9: CN15: Internal USB

Part Number	1653005260
Footprint	HD_5x2P_79_N10
Description	PIN HEADER 2*5P 180D(M) 2.0mm SMD IDIOT-PROOF
Pin	Pin Name
1	+5V
2	+5V
3	A_D-
4	B_D-
5	A_D+
6	B_D+
7	GND
8	GND
9	GND

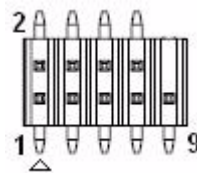

Matching Cable : 1703100121

Table A.10: CN16: 18 bits LVDS Panel	
Part Number	1653910261
Footprint	SPH10X2
Description	*CONN. SMD 10*2P 180D(M)DF13-20DP-1.25V(91) HRS
Pin	Pin Name
1	GND
2	GND
3	LVDS0_D0+
4	NC
5	LVDS0_D0-
6	NC
7	LVDS0_D1+
8	NC
9	LVDS0_D1-
10	NC
11	LVDS0_D2+
12	NC
13	LVDS0_D2-
14	NC
15	LVDS0_CLK+
16	NC
17	LVDS0_CLK-
18	NC
19	+5V or +3.3V
20	+5V or +3.3V

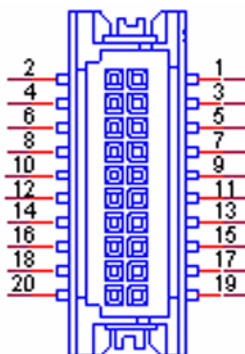

Table A.11: CN18: LAN1

Part Number	1652002996
Footprint	RJ45_14P_RTA-195AAK1A
Description	Phone Jack RJ45 14P 90D(M) DIP RTA-195AAK1A
Pin	Pin Name

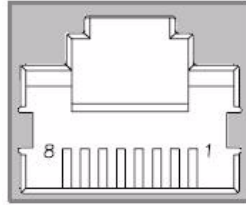

Table A.12: CN19: LAN2

Part Number	1652002996
Footprint	RJ45_14P_RTA-195AAK1A
Description	Phone Jack RJ45 14P 90D(M) DIP RTA-195AAK1A
Pin	Pin Name

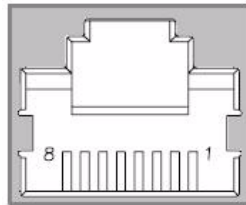

Table A.13: CN20: Power Switch (Low Active)

Part Number	1655302020
Footprint	WF_2P_79_BOX_R1_D
Description	WAFER BOX 2P 180D(M) 2.0mm W/Lock
Pin	Pin Name
1	PSIN
2	GND

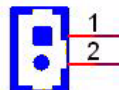

Table A.14: CN11: LPT

Part Number	1653213260
Footprint	HD_13x2P_79_BOX
Description	BOX HEADER 13*2P 180D(M) 2.0mm SMD
Pin	Pin Name
1	STROBE#
2	AUTOFEED#
3	D0
4	ERROR#
5	D1
6	INIT#
7	D2
8	SLCT IN#
9	D3
10	GND
11	D4
12	GND
13	D5
14	GND
15	D6

Table A.15: CN22: Standby Power Input

Part Number	1655303020
Footprint	WHL3V-2M
Description	WAFER BOX 2.0mm 3P 180D w/LOCK
Pin	Pin Name
1	+5VSB
2	GND
3	PSON#

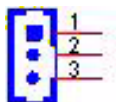

Table A.16: CN2: Reset

Part Number	1655302020
Footprint	WF_2P_79_BOX_R1_D
Description	WAFER BOX 2P 180D(M) 2.0mm W/Lock
Pin	Pin Name
1	RESET#
2	GND

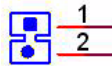

Table A.17: CN24: External USB

Part Number	1654904105
Footprint	USB-V-4A
Description	USB CON. 4P 90D(F) DIP A TYPE RoHS
Pin	Pin Name
1	+5V
2	D-
3	D+
4	GND



Table A.18: CN25: External USB

Part Number	1654904105
Footprint	USB-V-4A
Description	USB CON. 4P 90D(F) DIP A TYPE RoHS
Pin	Pin Name
1	+5V
2	D-
3	D+
4	GND

**Table A.19: CN26: COM1**

Part Number	1654000056
Footprint	DBCOM-VM5MS
Description	D-SUB CON. 9P 90D(M)DIP 070241MR009S200ZU SUYIN
Pin	Pin Name
1	DCD#
2	RXD
3	TXD
4	DTR#
5	GND
6	DSR#
7	RTS#
8	CTS#
9	RI#

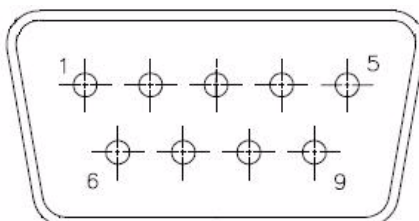

Table A.20: CN27: VGA

Part Number	1654000055
Footprint	DBVGA-VF5MS
Description	D-SUB Conn. 15P 90D(F) DIP 070242FR015S200ZU
Pin	Pin Name
1	RED
2	GREEN
3	BLUE
4	NC
5	GND
6	GND
7	GND
8	GND
9	NC
10	GND
11	NC
12	DDAT
13	HSYNC
14	VSYNC
15	DCLK

**Table A.21: CN28: Mini PCIE lock**

Part Number	1654002539
Footprint	FOX_AS0B226-S68K7F HOLDER
Description	MINI PCI Express LATCH 52P 90D SMD 6.8mm
Pin	Pin Name



Table A.22: CN29: Mini PCIE slot	
Part Number	1654002538
Footprint	FOX_AS0B226-S68K7F
Description	MINI PCI express 52P 90D SMD H=6.8mm
Pin	Pin Name
1	WAKE#
2	+3.3V or +3.3VSB
3	NC
4	GND
5	NC
6	+1.5V
7	CLKREQ#
8	NC
9	GND
10	NC
11	REFCLK-
12	NC
13	REFCLK+
14	NC
15	GND
16	NC
17	NC
18	GND
19	NC
20	NC
21	GND
22	PERST#
23	PERn0
24	+3.3VSB
25	PERp0
26	GND
27	GND
28	+1.5V
29	GND
30	SMB CLK
31	PETn0
32	SMB DAT
33	PETp0
34	GND
35	GND
36	USB D-
37	GND
38	USB D+
39	+3.3V or +3.3VSB
40	GND
41	+3.3V or +3.3VSB
42	NC

Table A.22: CN29: Mini PCIE slot

43	GND
44	NC
45	NC
46	NC
47	NC
48	+1.5V
49	NC
50	GND
51	NC
52	+3.3V or +3.3VSB
53	NC
54	NC
55	GND
56	GND

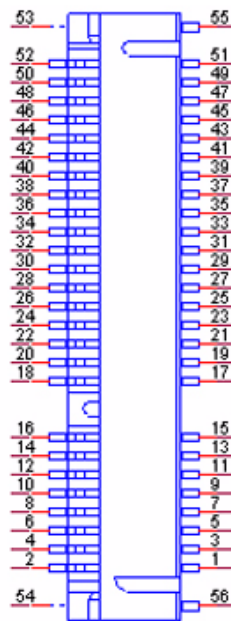

Table A.23: CN30: DDR2 SODIMM	
Part Number	1651000087
Footprint	DDR-SODIMM-STD65
Description	SKT DIMM 200P DDR2 H=6.5mm STD SMD WO/Pb
Pin	Pin Name
1	VREF
2	GND
3	GND
4	DQ59
5	DQ63
6	DQ58
7	DQ62
8	GND
9	GND
10	DM7
11	DQS#7
12	GND
13	DQS7
14	DQ57
15	GND
16	DQ56
17	DQ61
18	GND
19	DQ60
20	DQ51
21	GND
22	DQ50
23	DQ55
24	GND
25	DQ54
26	DM6
27	GND
28	GND
29	DQS#6
30	CK1
31	DQS6
32	CK1#
33	GND
34	GND
35	DQ53
36	DQ49
37	DQ52
38	DQ48
39	GND
40	GND
41	GND
42	GND

Table A.23: CN30: DDR2 SODIMM

43	DQ47
44	DQ43
45	DQ46
46	DQ42
47	GND
48	GND
49	DQS#5
50	NC
51	DQS5
52	DM5
53	GND
54	GND
55	DQ45
56	DQ41
57	DQ44
58	DQ40
59	GND
60	GND
61	DQ39
62	DQ35
63	DQ38
64	DQ34
65	GND
66	GND
67	DM4
68	DQS#4
69	NC
70	DQS4
71	GND
72	GND
73	DQ37
74	DQ33
75	DQ36
76	DQ32
77	GND
78	GND
79	CKE0
80	CKE1
81	+1.8V
82	+1.8V
83	NC
84	NC
85	BA2
86	A14
87	+1.8V
88	+1.8V
89	A12

Table A.23: CN30: DDR2 SODIMM	
90	A11
91	A9
92	A7
93	A8
94	A6
95	+1.8V
96	+1.8V
97	A5
98	A4
99	A3
100	A2
101	A1
102	A0
103	+1.8V
104	+1.8V
105	A10
106	BA1
107	BA0
108	RAS#
109	WE#
110	SCS#0
111	+1.8V
112	+1.8V
113	CAS#
114	ODT0
115	SCS#1
116	A13
117	+1.8V
118	+1.8V
119	ODT1
120	NC
121	GND
122	GND
123	DQ31
124	DQ27
125	DQ30
126	DQ26
127	GND
128	GND
129	DQS#3
130	DM3
131	DQS3
132	GND
133	GND
134	DQ25
135	DQ29
136	DQ24

Table A.23: CN30: DDR2 SODIMM

137	DQ28
138	GND
139	GND
140	DQ19
141	DQ23
142	DQ18
143	DQ22
144	GND
145	GND
146	DQS#2
147	DM2
148	DQS2
149	GND
150	GND
151	DQ21
152	DQ17
153	DQ20
154	DQ16
155	GND
156	GND
157	DQ15
158	DQ11
159	DQ14
160	DQ10
161	GND
162	GND
163	NC
164	CK0
165	GND
166	CK0#
167	DQS#1
168	GND
169	DQS1
170	DM1
171	GND
172	GND
173	DQ13
174	DQ9
175	DQ12
176	DQ8
177	GND
178	GND
179	DQ7
180	DQ3
181	DQ6
182	DQ2
183	GND

Table A.23: CN30: DDR2 SODIMM

184	GND
185	DM0
186	DQS#0
187	GND
188	DQS0
189	DQ5
190	GND
191	DQ4
192	DQ1
193	GND
194	DQ0
195	SDA
196	GND
197	SCL
198	SA0
199	+3.3V
200	SA1

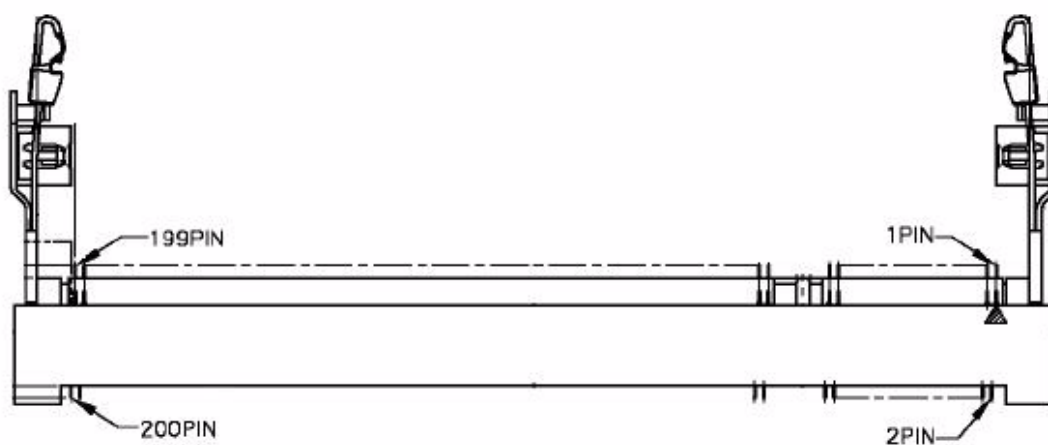
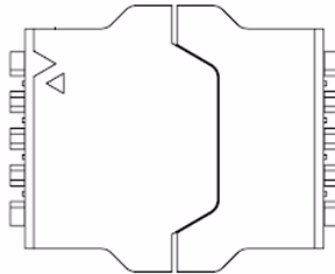

Table A.24: CN31: BIOS Socket

Part Number	1651000682
Footprint	SOCKET_8P_ACA-SPI-004-K01
Description	IC SKT 8P SMD WO/Pb C ACA-SPI-004-K01
Pin	Pin Name
1	CE#
2	SO
3	WP#
4	GND
5	SI
6	SCK
7	HOLD#
8	+3.3V

**Table A.25: CN32: CF**

Part Number	1653002919
Footprint	CF_50P_CFCMD-35T15W100
Description	CF Type2 Conn.50P 90D(M) SMD WO/Pb CFCMD-35T15W1
Pin	Pin Name
1	GND
2	D03
3	D04
4	D05
5	D06
6	D07
7	CS0#
8	GND
9	GND
10	GND
11	GND
12	GND
13	+5V
14	GND
15	GND
16	GND
17	GND
18	A02
19	A01

Table A.25: CN32: CF

20	A00
21	D00
22	D01
23	D02
24	NC
25	CD2#
26	CD1#

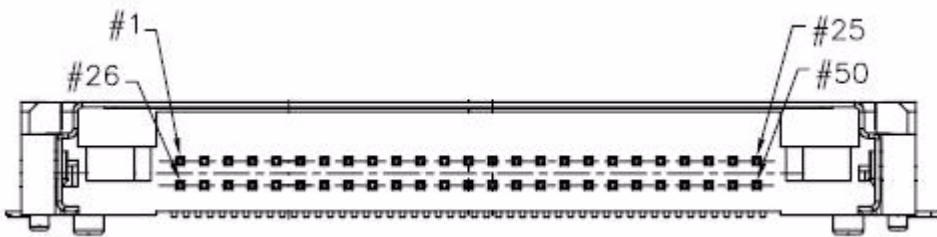
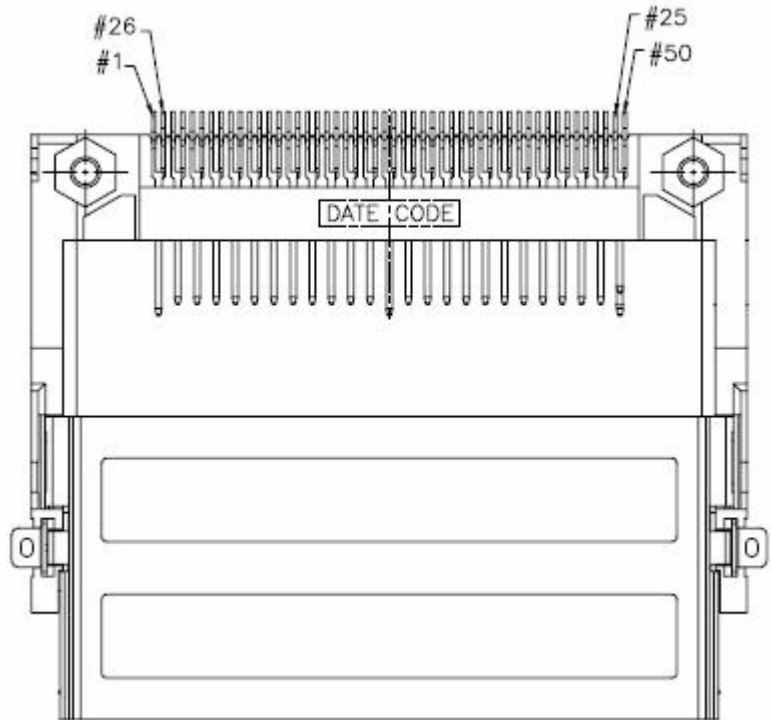

Appendix **B**

UTC-500 Peripherals
Series Installation
Guide

B.1 UTC-500 Peripherals Series Installation Guide

Model	Description
UTC-P01-A0E	2M Camera Module for UTC-500 Series
UTC-P02-A0E	Magnetic Stripe Card Reader for UTC-500 Series
UTC-P03-A0E	RFID Reader for UTC-500 Series
UTC-P06-A0E	Smart Card Reader for UTC-500 Series

Packing List

- UTC-PXX
- CD-Driver
- Cable Clamp x 2

Assemble the UTC-Peripherals

1. Attach the UTC-peripheral to the UTC 500 series side groove.
(The UTC-500's uniquely designed side groove creates an attachment area that runs all around the frame; customer's can easily attach peripherals to it for their applications.)



2. Fasten the 2 screws to fix the peripheral in place.



3. Connect the cable to an I/O port (USB).

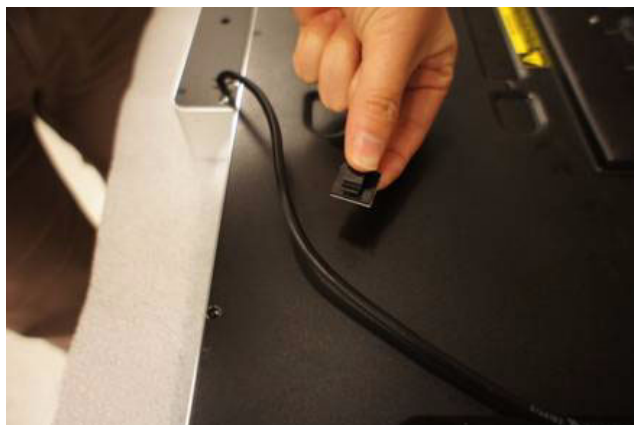

4. Choose a location to put the cable clamp and attach the cable to it.



Attaching a peripheral on the top of the unit



Attaching a peripheral on the bottom of the unit

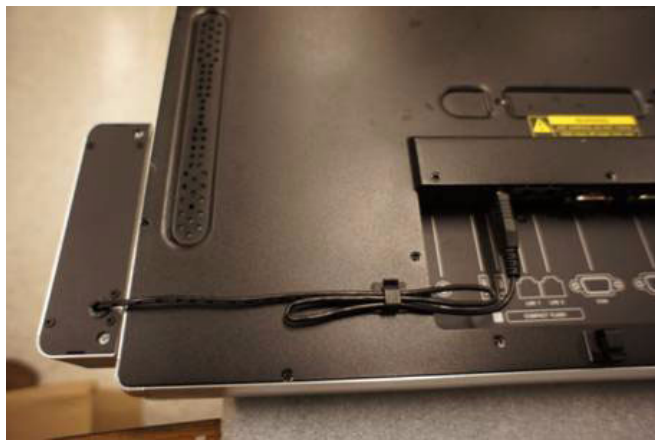

An attachment to the left side

Trusted ePlatform Services

ADVANTECH

www.advantech.com

Please verify specifications before quoting. This guide is intended for reference purposes only.

All product specifications are subject to change without notice.

No part of this publication may be reproduced in any form or by any means, electronic, photocopying, recording or otherwise, without prior written permission of the publisher.

All brand and product names are trademarks or registered trademarks of their respective companies.

© Advantech Co., Ltd. 2011

