

UNO-4683

**Intel Core i7 Dual Core Automation Computer with 6xLAN,
2xCOM, 3 expansion slots**

User Manual

Copyright

This document is copyrighted, © 2011. All rights are reserved. The original manufacturer reserves the right to make improvements to the products described in this manual at any time without notice.

No part of this manual may be reproduced, copied, translated or transmitted in any form or by any means without the prior written permission of the original manufacturer. Information provided in this manual is intended to be accurate and reliable. However, the original manufacturer assumes no responsibility for its use, nor for any infringements upon the rights of third parties that may result from such use.

Acknowledgements

Intel, Pentium and Celeron are registered trademarks of Intel Corp.

Microsoft Windows and MS-DOS are registered trademarks of Microsoft Corp.

All other product names or trademarks are properties of their respective owners.

Support

For more information on this and other Advantech products, please visit our websites at: **<http://www.advantech.com>**

For technical support and service, please visit our support website at: **<http://www.advantech.com/support/>**

This manual is for UNO-4683.

Part No. 2003468300

1st Edition

Printed in Taiwan

December 2011

Product Warranty (2 years)

Advantech warrants to you, the original purchaser, that each of its products will be free from defects in materials and workmanship for two years from the date of purchase.

This warranty does not apply to any products that have been repaired or altered by persons other than repair personnel authorized by Advantech, or which have been subject to misuse, abuse, accident or improper installation. Advantech assumes no liability under the terms of this warranty as a consequence of such events.

Because of Advantech high quality-control standards and rigorous testing, most of our customers never need to use our repair service. If an Advantech product is defective, it will be repaired or replaced at no charge during the warranty period. For out-of-warranty repairs, you will be billed according to the cost of replacement materials, service time and freight. Please consult your dealer for more details. If you think you have a defective product, follow these steps:

- Step 1. Collect all the information about the problem encountered. (For example, CPU speed, Advantech products used, other hardware and software used, etc.) Note anything abnormal and list any on-screen messages you get when the problem occurs.
- Step 2. Call your dealer and describe the problem. Please have your manual, product, and any helpful information readily available.
- Step 3. If your product is diagnosed as defective, obtain an RMA (return merchandise authorization) number from your dealer. This allows us to process your return more quickly.
- Step 4. Carefully pack the defective product, a fully completed Repair and Replacement Order Card and a photocopy proof of purchase date (such as your sales receipt) in a shippable container. A product returned without proof of the purchase date is not eligible for warranty service.
- Step 5. Write the RMA number visibly on the outside of the package and ship it prepaid to your dealer.

CE

This product has passed the CE test for environmental specifications. Test conditions for passing included the equipment being operated within an industrial enclosure. In order to protect the product from being damaged by ESD (Electrostatic Discharge) and EMI leakage, we strongly recommend the use of CE-compliant industrial enclosure products.

FCC Class A

This equipment has been tested and found to comply with the limits for a Class A digital device, pursuant to Part 15 of the FCC Rules. These limits are designed to provide reasonable protection against harmful interference when the equipment is operated in a commercial environment. This equipment generates, uses and can radiate radio frequency energy and, if not installed and used in accordance with the instruction manual, may cause harmful interference to radio communications. Operation of this equipment in a residential area is likely to cause harmful interference in which case the user will be required to correct the interference at his own expense.

Technical Support and Assistance

- Step 1. Visit the Advantech web site at **www.advantech.com/support** where you can find the latest information about the product.
- Step 2. Contact your distributor, sales representative, or Advantech's customer service center for technical support if you need additional assistance. Please have the following information ready before you call:
 - Product name and serial number
 - Description of your peripheral attachments
 - Description of your software (OS, version, software, etc.)
 - A complete description of the problem
 - The exact wording of any error messages

Safety Instructions

1. Read these safety instructions carefully.
2. Keep this User's Manual for later reference.
3. Disconnect this equipment from any AC outlet before cleaning. Use a damp cloth. Do not use liquid or spray detergents for cleaning.
4. For plug-in equipment, the power outlet socket must be located near the equipment and must be easily accessible.
5. Keep this equipment away from humidity.
6. Put this equipment on a reliable surface during installation. Dropping it or letting it fall may cause damage.
7. The openings on the enclosure are for air convection. Protect the equipment from overheating. **DO NOT COVER THE OPENINGS.**
8. Make sure the voltage of the power source is correct before connecting the equipment to the power outlet.
9. Position the power cord so that people cannot step on it. Do not place anything over the power cord.
10. All cautions and warnings on the equipment should be noted.
11. If the equipment is not used for a long time, disconnect it from the power source to avoid damage by transient overvoltage.
12. Never pour any liquid into an opening. This may cause fire or electrical shock.
13. Never open the equipment. For safety reasons, the equipment should be opened only by qualified service personnel.
14. If one of the following situations arises, get the equipment checked by service personnel:
 - a. The power cord or plug is damaged.
 - b. Liquid has penetrated into the equipment.
 - c. The equipment has been exposed to moisture.
 - d. The equipment does not work well, or you cannot get it to work according to the user's manual.
 - e. The equipment has been dropped and damaged.
 - f. The equipment has obvious signs of breakage.
15. **DO NOT LEAVE THIS EQUIPMENT IN AN ENVIRONMENT WHERE THE STORAGE TEMPERATURE MAY GO BELOW**

-20°C (-4°F) OR ABOVE 70°C (158°F). THIS COULD DAMAGE THE EQUIPMENT. THE EQUIPMENT SHOULD BE IN A CONTROLLED ENVIRONMENT.

16. CAUTION: DANGER OF EXPLOSION IF BATTERY IS INCORRECTLY REPLACED. REPLACE ONLY WITH THE SAME OR EQUIVALENT TYPE RECOMMENDED BY THE MANUFACTURER, DISCARD USED BATTERIES ACCORDING TO THE MANUFACTURER'S INSTRUCTIONS.
17. Due to the sensitive nature of the equipment it must be stored in a restricted access location, only accessible by qualified engineers.
18. When installing this equipment, ensure that the Earth cable is securely attached using a 3.5mm screw.
19. The equipment does not include a power cord and plug.

The sound pressure level at the operator's position according to IEC 704-1:1982 is no more than 70 dB (A).

DISCLAIMER: This set of instructions is given according to IEC 704-1. Advantech disclaims all responsibility for the accuracy of any statements contained herein.

Safety Precaution - Static Electricity

Follow these simple precautions to protect yourself from harm and the products from damage.

- To avoid electrical shock, always disconnect the power from your PC chassis before you work on it. Don't touch any components on the CPU card or other cards while the PC is on.
- Disconnect power before making any configuration changes. The sudden rush of power as you connect a jumper or install a card may damage sensitive electronic components.

For AC Power Supply

- The AC power supply cord shall be used with UL approved and one end is plug type and other end is terminal type (18 AWG min.)

For DC Power Supply

- The DC power supply cable shall be used with UL approved and suitable terminal (18 AWG min.).
- A readily accessible approved circuit breaker shall be incorporated in the field wiring.

Contents

Chapter 1	Overview	2
1.1	Introduction	2
1.2	Hardware Specifications	5
1.3	Safety Precautions	7
1.4	Chassis Dimensions.....	8
	Figure 1.1:Chassis Dimensions	8
1.5	Packing List.....	8
Chapter 2	Hardware Functionality	10
2.1	Overview	10
	Figure 2.1:UNO-4683 Front Panel	10
	Figure 2.2:UNO-4683 Rear Panel	10
2.2	LED Indicators	11
2.2.1	System Status Indicators	11
	Table 2.1:Definition of System Status Indicators	11
2.2.2	LAN Status Indicators	12
	Table 2.2:Definition of LAN Status Indicators	12
2.2.3	Serial Communication Status Indicators	13
	Table 2.3:Definition of Serial COM Status Indicators	13
2.2.4	Indicators for Expansion Slots	13
2.3	Power Input	14
	Table 2.4:AC/DC Power Input	14
	Table 2.5:AC/DC Power Input Function Introduction	14
2.4	RS-232/422/485 Interface (COM1, COM2)	15
2.4.1	OXuPCI952 UARTs with 128 bytes FIFO	15
2.4.2	RS-422/485 Detection	15
2.4.3	Automatic Data Flow Control Function for RS-485	15
2.4.4	Terminal Resistor (SW6,SW8)	16
	Table 2.6:Jumper setting of terminal resistor	16
	Table 2.7:Mapping table of Jumper/DIP for COM port ..	16
2.4.5	RS-232/422/485 Selection	17
	Figure 2.3:RS-422/485 Jumper Setting	17
	Figure 2.4:RS-232 Jumper Setting	17
2.4.6	RS-485 Auto Flow & RS-422 Master/Slave Modes	18
	Table 2.8:SW3 DIP Setting	18
2.4.7	Redundant RS-422 Matter	18
	Table 2.9:Mapping table of switches for COM port	18
2.5	LAN: Ethernet Connector	19
2.6	USB Ports.....	19
2.7	DVI-I Display.....	19
2.8	Battery Backup SRAM.....	20
2.8.1	Lithium Battery Specifications	20
2.9	Relay Output for Event	21
	Table 2.10:Definition of SW9 for events	21
2.10	Advanced Watchdog Timer	21

2.11	Expansion Slots.....	22
Chapter 3	Initial Setup.....	24
3.1	Configuration	24
	Figure 3.1:Location for Configuration	25
3.2	Install a USB Dongle.....	25
3.3	Install a Hard Disk.....	26
	Figure 3.2:Location of SATA connections	27
3.4	Installing in a Rack.....	28
3.5	BIOS Setup and System Assignments	29
Appendix A	System Settings & Pin Assignments	32
A.1	System I/O Address & Interrupt Assignments	32
	Table A.1: UNO-4683 System I/O Ports	32
	Table A.2: UNO-4683 Interrupt Assignment	33
A.2	RS-232/422/485 Serial Ports (COM1~COM2).....	34
	Table A.3:RS-232 Serial Ports COM1~2	34
A.3	USB Connectors.....	35
	Table A.4:USB Connector Pin Assignments	35
A.4	DVI-I Connector	35
	Table A.5:DVI Connector Pin Assignments	35
A.5	SATA Hard Drive RAID Support.....	37

Overview

This chapter provides an overview of UNO-4683's specifications.

Sections include:

- Introduction
- Hardware Specifications
- Safety Precautions
- Chassis Dimensions
- Packing List

Chapter 1 Overview

1.1 Introduction

UNO-4683 is an embedded Application Ready Platform (ARP) that can shorten development time and offers rich networking interfaces to fulfill extensive needs. UNO-4683 is designed to be a total solution for network enabled Application Ready Platforms.

Leveraging field-approved and worldwide approved real-time OS technology, Advantech UNO-4683 series provides a Windows XP Embedded ready solution, and supports several standard networking interfaces, such as Ethernet, RS-232/422/485 and more. Because of its openness, great expansion capability and reliable design (fanless and diskless), the UNO-4683 series are ideal embedded platforms for implementing custom applications for diverse applications.

Target on Data Server and Communication Gateway in Substations

Advantech UNO-4683 has been defined and designed to be compliant with IEC-61850-3, which has been defined as an international hardware standard of communication network and system in power substations. In modern power substation, this standard facilitate the management to large number of devices and enable the various devices to communicate with one another. UNO-4683 is a ready and certified platform to serve all these requirement.

3x Expansion Slots for Substation Domain IO

UNO-4683 offer 3 expansion slots for modularized domain IO plug-in card. With these expansion slots, UNO-4683 can optional equips isolated serial ports, IRIG-B, as well as fiber optical Ethernet interface.

If user need to plug in the ordinary plug-in card, UNO-4683 can also support the interface module to provide PCI, PCIe-mini card slot, mini-PCI and PCI-104.

Some of the application need to install 2nd HDD. UNO-4683 can also optional provide the HDD kit to install HDD in the expansion slot.

Open Architecture Designed for Automation

For applications demanding customized control, an UNO-4683 that uses more flexible, off-the-shelf technology is a better option. UNO-4683 uses off-the-shelf components such as an x86 processor, an Ethernet chipset, CompactFlash[®], and DRAM. At the same time, the UNO-4683 unit can broadcast the process data through the Ethernet and share the data with operators and managers. By using off-the-shelf components, machine builders can customize the control scheme they use for other machines that require multiple inputs, optimized control, or Ethernet communication. So, UNO-4683 offers the I/O connectivity of PCs with options like: 6 x Ethernet (2 x 10/100/1000 Base-T, 4 x 10/100 Base-T), 2 x Serial ports (2 x RS-232/422/485), 6 x USB ports (2 x Front, 3 x Rear, 1 x Internal), 1 x CompactFlash and DVI-I interface for display panels.

Robust IO Isolate System from Electrical Noise

UNO-4683 is designed for the applications in substation where is supposed to have certain electric interference. Equipping with isolated power and isolated communication ports, UNO-4683 has high resistance toward electrical noise. It has been proved not only can work well in substation but also suitable for any harsh applications

An Industry-Proven Design

Industrial applications require controllers with high-vibration specifications and a wide temperature range. Controllers in industrial environments require flexible and stable mounting, and many machine builders underestimate the need for rugged controllers because their applications are mounted in an industrial enclosure. UNO-4683 has a special design without the weaknesses of a standard PC. No fan, and no HDD prevent dust and vibration problems. With a smart mechanical design, UNO-4683 can meet 50 G shock (with CompactFlash), 2 G vibration (with CompactFlash), up to 70°C operating temperature (tested under 100% CPU loading) and almost anything an industrial environments demand.

Designed to Fit Comfortably Into Racks

In completely new packaging, UNO-4683 has standard 2U rack size as 440 x 280 x 88 mm (W x H x D) could fit your rack. The rear IO connection and indicator LEDs on the front panel for all ports and modes highly simplify monitoring for operation and maintenance in the rack. You could easily mount UNO-4683 on rack, manage all UNOs in one rack and easily develop your application on rack.

Popular Operating Systems and Rapid Application Development

The Advantech UNO-4683 supports the popular off-the-shelf Microsoft Windows 2000/NT/XP operating systems and the Linux operating system. UNO-4683 also features pre-built Microsoft Windows XP embedded solutions offering a pre-configured image with optimized onboard device drivers. Microsoft Windows CE and XP Embedded are compact, highly efficient, and real-time operating systems that are designed for embedded systems without a HDD. There is no need to waste time and energy on developing onboard device drivers or using the Platform Builder to build a custom Windows CE image, they have all been done for the Advantech UNO-4683 series! Through the built-in runtime library and Software Development Kit (SDK), the UNO-4683 series leverages your existing Windows-based programming skills to rapidly develop applications.

1.2 Hardware Specifications

General

Certifications	EC 61850-3, IEEE 1613, CE, FCC Class A, UL, CCC
Dimensions (W x D x H)	2U (440 x 280 x 88) mm (17.3" x 11" x 3.4") fits into standard 19 inch rack
Enclosure	SECC
Mounting	2U Rackmount
Power Consumption	60W (Typical, no added on card)
Power Requirements	AC: 90 ~ 250 V _{AC} DC: 106 ~ 250 V _{DC} With isolation protection, AT
Weight	6.0 kg
OS Support	WES, Windows XP Embedded, Windows 2000/XP, Windows CE 6.0, Linux, QNX
System Design	Fanless with no internal cabling
Remote Management	Built-in Advantech DiagAnywhere agent on Windows CE/XPe

System Hardware

CPU	Intel Dual Core i7 620LE 2.0GHz
Memory	4G DDR3 SDRAM
Indicators	LEDs for Power, IDE, Alarm for battery backup SRAM, Diagnosis (programmable), LAN (Active, Status) and Serial (Tx, Rx)
Keyboard/Mouse	2 x PS/2 connector for Keyboard & Mouse
Storage	CF - 1 x internal type I/II CompactFlash slot HDD - Built-in one 2.5" SATA HDD bracket
Display	DVI-I connector
HDD	SATA HDD extension kit (UNOP-1901-AE) for 2nd standard 2.5" HDDs RAID 0/1 function support

Watchdog Timer Programmable 7-tier event handler, from 1 to 255 seconds for each tier

Battery Backup SRAM 1 MB

I/O Interface

Serial Ports 2 x DB-9
Automatic RS-485 data flow control
2000 V_{DC} isolation

Serial Port Speed RS-232: 50 ~ 115.2 kbps
RS-422/485: 50 ~ 921.6 kbps (Max.)

LAN 2 x 10/100/1000 Base-T RJ-45 ports, teaming function supported

4 x 10/100Base-T RJ-45 ports

Audio Line-out

USB Ports 6 x USB, UHCI, Rev. 2.0 compliant
2 x Front, 3 x Rear and 1 x Internal ports

Expansion 3 x Domain I/O expansions (Only slot 1 supports PCIe resource)
Power support for each slot
5V@ 2A, 3.3V@1.5A, 12V@0.25A

Maximum 30 Watt for all slot @ condition of 50°C operation temperature

Environment

Humidity 95% @ 40°C (non-condensing)

Operating Temperature IEC 60068-2-2 with 100% CPU/ I/O loading, 48 hrs

-20 ~ 70°C (optional for -40°C)

Safety Cert. Temperature: -20~50°C (-4~122° F)

Operating Humidity 20 ~ 95% (non-condensing)

Shock Protection IEC 60068-2-27 CompactFlash 50 G half sine, 11 ms HDD: 20 G half sine, 11 ms

Vibration Protection EC 60068-2-64 (Random 1 Oct./min, 1hr/axis.) CompactFlash? 2 Grms @ 5 ~ 500 Hz,

HDD: 1 Grms @ 5 ~ 500 Hz

1.3 Safety Precautions

The following messages inform how to make each connection. In most cases, you will simply need to connect a standard cable.

Warning!



Always disconnect the power cord from your chassis whenever you are working on it. Do not connect while the power is on. A sudden rush of power can damage sensitive electronic components. Only experienced electronics personnel should open the chassis.

Caution!



Always ground yourself to remove any static electric charge before touching UNO-4683. Modern electronic devices are very sensitive to static electric charges. Use a grounding wrist strap at all times. Place all electronic components on a static-dissipative surface or in a static-shielded bag.

Attention!

If DC voltage is supplied by an external circuit, please put a protection device in the power supply input port.

1.4 Chassis Dimensions

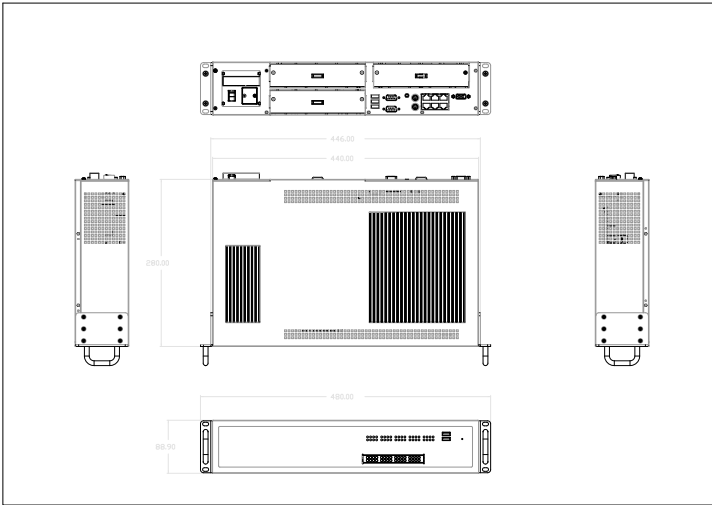

Figure 1.1: Chassis Dimensions

1.5 Packing List

The accessory package of UNO-4683 contains the following items:

- (A) UNO-4683
- (B) 2 x rack mounting kit
- (C) 12 x screw for rack mount kit
- (D) 2 x front handles
- (E) 4 x screws for front handles
- (F) 1 x SATA signal cable
- (G) 1 x SATA power cable
- (H) 4 x screws for SATA HDD installation
- (I) 1x clamp for USB dongle
- (J) 2x screws for USB clamp
- (K) UNO series Driver and Utility DISC
- (L) 1 x warranty card

Hardware Functionality

This chapter shows how to setup the UNO-4683's hardware functions, including connecting peripherals, setting switches and indicators.

Sections include:

- Overview
- LED Indicators
- Power Input
- RS-232 Interface
- RS-232/422/485 Interface
- LAN / Ethernet Connector
- USB Ports
- DVI-I Display
- Battery Backup SRAM
- Onboard Isolated Digital Input
- Onboard Isolated Digital Output
- Onboard Isolated Counter/Timer
- LED & Buzzer for System Diagnosis
- PC/104+

Chapter 2 Hardware Functionality

2.1 Overview

The following two figures show the indicators, connectors and expansion slots on the UNO-4683. The following sections give you detailed information about function of each peripheral.



Figure 2.1: UNO-4683 Front Panel



Figure 2.2: UNO-4683 Rear Panel

2.2 LED Indicators

The LEDs in the front panel can be divided into 4 groups.

2.2.1 System Status Indicators

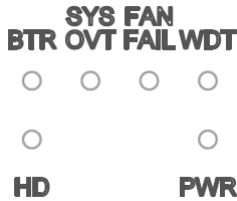

Table 2.1: Definition of System Status Indicators

Item	LED	Status	Description
1	PWR	Green	System power is on
		Off	System power is off
2	HD	Green	Data being received/ transmitted between on CF/SATA
		Off	No Data being received/ transmitted on CF/ SATA
3	WDT	Red	WDT trigger the LED for alarm
		Off	Default
4	BTR	Red	Battery for backup SRAM should be replaced
		Off	Status of battery for backup is OK
5	SYS OVT	Red	System over temperature alarm
		Off	Default
6	FAN FAIL (Optional)	Red	System fan fail
		Off	Default

2.2.2 LAN Status Indicators

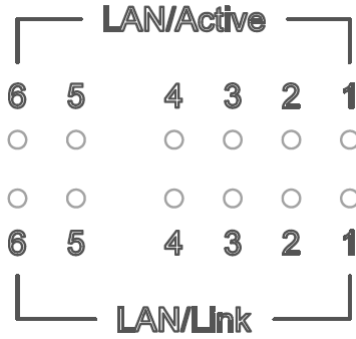

Table 2.2: Definition of LAN Status Indicators

Item	LED	Status	Description
1	LAN/Link (Port 1~2)	Green	1Gbps network link
		Orange	100Mbps network link
		Off	10Mbps network link or invalid network link
2	LAN/Link (Port 3~6)	Orange	100Mbps network link
		Off	10Mbps network link or invalid network link
3	LAN/Active (Port 1~6)	Green	Ethernet data being received/ transmitted
		Off	No Ethernet data being received/ transmitted

2.2.3 Serial Communication Status Indicators



Table 2.3: Definition of Serial COM Status Indicators

Item	LED	Status	Description
1	COM/Rx (Port 1,2)	Green	Serial port data being received
		Off	No data being received
2	COM/Tx (Port 1,2)	Orange	Serial port data being transmitted
		Off	No data being transmitted

2.2.4 Indicators for Expansion Slots

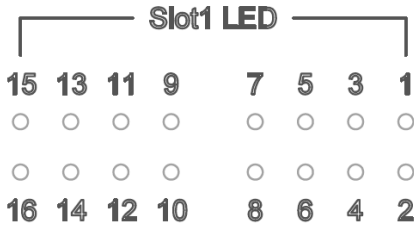

These LED indicators are defined by the UNOP series expansion modules, please refer to the related document for the definition.

2.3 Power Input

The UNO-4683 support AC/DC power input to fulfill the need of field site. Following table shows the specification of the power input.

Table 2.4: AC/DC Power Input

AC/DC	Volt. Range	Power Rating	Connector Type
AC	90-250V	2 - 0.8A, 47- 63Hz	3Pin Screw Terminal
DC	106-250V	2 - 0.8A	3Pin Screw Terminal

The function of each part is described as below:

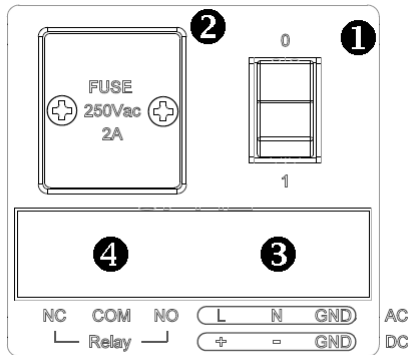

Table 2.5: AC/DC Power Input Function Introduction

Item	Function Description
1	AT power switch for AC/DC power input
2	Fuse for AC/DC power input
3	Screw terminal for AC/DC power input
4	Relay output by event

2.4 RS-232/422/485 Interface (COM1, COM2)

The UNO-4683 offers two RS-232/422/485 serial communication interface ports: COM1 and COM2. Please refer to Appendix A.2 for their pin assignments. The default setting of COM1 and COM2 are RS-232.

2.4.1 OXuPCI952 UARTs with 128 bytes FIFO

Advantech UNO-4683 comes with Oxford OXuPCI952 UARTs containing 128 bytes FIFOs.

2.4.2 RS-422/485 Detection

In RS-422/485 mode, UNO-4683 automatically detects signals to match RS-422 or RS-485 networks. (No jumper change required)

2.4.3 Automatic Data Flow Control Function for RS-485

In RS-485 mode, UNO-4683 automatically detects the direction of incoming data and switches its transmission direction accordingly. So no handshaking signal (e.g. RTS signal) is necessary. This lets you conveniently build an RS-485 network with just two wires. More importantly, application software previously written for half duplex RS-232 environments can be maintained without modification.

2.4.4 Terminal Resistor (SW6,SW8)

The onboard termination resistor (120 ohm) for COM1, COM2 can be used for long distance transmission or device matching. (Default Open.) Please also refer to Table 2.9 for the mapping table of Jumper and COM port.

Table 2.6: Jumper setting of terminal resistor

DIP	Status	Description
1	ON	Add terminal resistor on Tx+/Tx- of RS-422 or Data+/Data- of RS-485
	OFF	No terminal resistor (Default)
2	ON	Add terminal resistor on Rx+/Rx- of RS-422
	OFF	No terminal resistor (Default)

Table 2.7: Mapping table of Jumper/DIP for COM port

COM port	Jumper for RS-232 and RS-422/485 selection	SW3 DIP switch for Auto-flow control	Jumper for Terminal Resistor
COM1	CN12	DIP1	SW6
COM2	CN14	DIP2	SW8

2.4.5 RS-232/422/485 Selection

COM1, COM2 support RS-232, RS-422 and RS-485 interfaces. The system detects RS-422 or RS-485 signals automatically in RS-422/485 mode. To select between RS-422/485 and RS-232 for COM1, COM2, adjust CN12, CN14 and Table 2.9 shows the mapping table.

Jumper settings for RS-422/485 interface: (CN12, CN14)

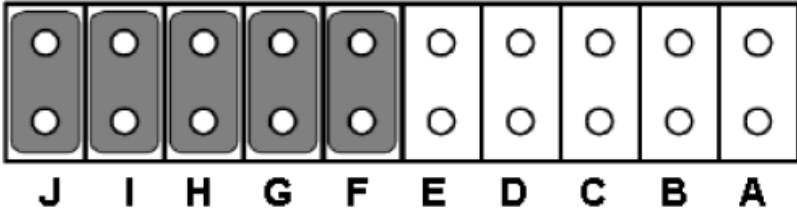

Figure 2.3: RS-422/485 Jumper Setting

Jumper settings for RS-232 interface: (Default setting) (CN12, CN14)

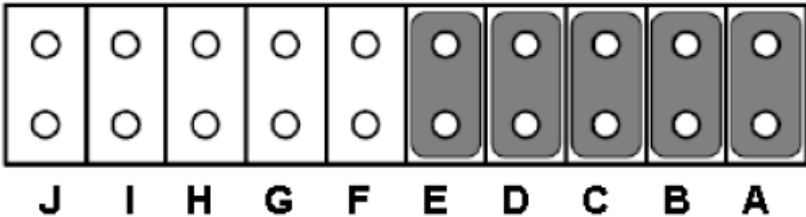

Figure 2.4: RS-232 Jumper Setting

2.4.6 RS-485 Auto Flow & RS-422 Master/Slave Modes

You can set the “Auto Flow Control” mode of RS-485 or “Master/Slave” mode of RS-422 by using the SW3 DIP switch for COM1, COM2. Please also refer to Table 2.9 for the COM port mapping with the DIP.

In RS-485, if the switch is set to “Off”, the driver automatically senses the direction of the data flow and switches the direction of transmission. No handshaking is necessary.

In RS-422, if DIP switch is set to “On,” the driver is always enabled, and always in high or low status. Please refer below for the default setting.

Table 2.8: SW3 DIP Setting

SW3 Status	Description
ON	RS-422: Master mode RS-485: N/A
OFF (Default)	RS-422: Slave mode RS-485: Auto flow control

2.4.7 Redundant RS-422 Matter

In the occasion that UNO-4683 RS-422 ports need to act as multi-master in parallel with other RS-422 master ports. Because of the auto detection function, the TX port will also receive data from other RS-422 master. To avoid this situation in this kind of application, user can use SW5 and SW7 to turn it off, then no data will be received from TX port. Please refer to the Table 2.11 for the COM port mapping and refer to Figure 2.3 for the location.

Table 2.9: Mapping table of switches for COM port

COM port	Switches	Status
COM1	SW5	ON: Normal (default)
COM2	SW7	OFF: RS-422 multi-master

2.5 LAN: Ethernet Connector

The UNO-4683 is equipped with 2 Intel 82574L Gigabit Ethernet Controller which are compliant with IEEE802.3 1000Base-T, 100Base-TX and 10Base-T (802.3, 802.3u and 802.3ab). And it is also equipped with 4 Realtek RTL8100CL Network controllers which are compliant with IEEE 802.3u 10/ 100Base-T CSMA/CD standards.

The Ethernet port provides a standard RJ-45 jack on board, and LED indicators on the front side to show its Link and Active status.

Please note these LAN controllers all use PCI resource, the bandwidth or throughput may be restricted by the PCI bandwidth.

2.6 USB Ports

The UNO-4683 provides six USB interface connectors, which provide complete Plug & Play and hot swapping for up to 127 external devices.

The USB interface complies with USB UHCI, Rev. 2.0 compliant. The USB interface can be disabled in the system BIOS setup.

UNO-4683 provides 2 USB port on the front panel, and 3 USB port on the rear panel. It also provides 1 USB port inside the chassis for USB dongle key.

2.7 DVI-I Display

UNO-4683 with Intel GMA integrated in Core i7.

The UNO-4683 provides DVI-I interface, powered by Intel Core i7 accelerator. It integrates both analog and digital video signal. This supports high-speed, high-resolution digital display and traditional analog display. You could link your DVI or VGA monitor through a DVI-I to DVI and VGA cable (Advantech P/N: 1700004713). For a detailed DVI-I pin assignment, please refer to A.4.

2.8 Battery Backup SRAM

UNO-4683 provides 1MB of battery backup SRAM. This ensures that you have a safe place to store critical data. You can now write software applications without being concerned that system crashes will erase critical data from the memory.

There is a BTR LED in the front panel of the UNO-4683, please replace the lithium battery with a new one if the BTR LED is activated.

2.8.1 Lithium Battery Specifications

- **Type:** BR2032 (Using CR2032 is NOT recommended)
- **Output voltage:** 3 V_{DC}
- **Location:** the backside of UNO-4683 board
(BH1 is for real time clock, BH2 is for SRAM)

2.9 Relay Output for Event

To reduce the down time of device or prevent the system fail, UNO-4683 provides the relay output function for some events. There is a OR gate to handle these events with the relay output.

The SW9 can enable or disable the linkage of each event with the relay output. Adjust the DIP switch ON to enable the linkage of the event with the relay output

Table 2.10: Definition of SW9 for events

DIP	Description of events	Remark
1	Fan Failed	Optional
2	System Over Temperature	Default 90°C
3	BBSRAM Failed	Change Battery
4	WDT Alarm	

By using the relay output, UNO-4683 can pass event notifications on to SCADA.

Some of the parameters can be setup in the BIOS, please check the related function in the BIOS.

2.10 Advanced Watchdog Timer

The UNO-4683 provides a 7-tier Watchdog Timer for users to have a chance to escalate system status before the forced system reset. Each tier has the same time interval from 1~255 seconds and users can have an event handling after the time-out of each tier. Install the driver from companion disc and refer to the software manual for details.

2.11 Expansion Slots

UNO-4683 offers 3 expansion slots for modularized domain IO plug-in card. Through the interface card, UNO-4683 can also adopt the standard PCI card, PCIe-mini card, mini-PCI card as well as the PCI-104 card.

Due to the UNO-4683 is an embedded system, the power providing for the expansion slot is limited. The maximum power support for each slot are:

- 5V@ 2A
- 3.3V@1.5A
- 12V@0.25A

And totally support maximum 30W (at 50°C condition) for all slots. Before you configure all the module and plug-in card, please note not to exceed the power limit.

All the expanding IO modules are design for embedded application, the power efficiency and thermal are well controlled. But if 3rd plug-in card is required to work in the UNO-4683, please check the related power consumption and working condition carefully. In the normal condition, the ambience temperature inside the chassis would be 15°C higher than the environment temperature of UNO-4683. To avoid the abnormal high internal temperature damage the plug-in card, UNO-4683 provide the system temperature alarm function, please refer to chapter 2.9 for detail.

UNO-4683 also support the optional fan for user to resolve the thermal issue of the 3rd party plug-in card which is with high power consumption or bad power efficiency. It is not recommended to use this kind of card in the embedded system, only while the plug-in card is mandatory, please contact Advantech for this optional support.

CHAPTER
3

Initial Setup

Chapter 3 Initial Setup

3.1 Configuration

To open the chassis, please follow the steps below:

1. Remove all power and signal connections
2. Place the unit with the heat-sink side down
3. Remove the plug-in module in the slot 3
4. Remove the screws on the cover

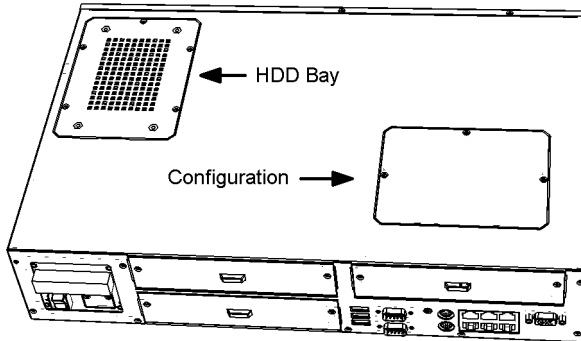

5. Install a Well-configured CompactFlash Card in this area
6. Install a USB device in this area
7. Refer to this manual to configure the COM ports

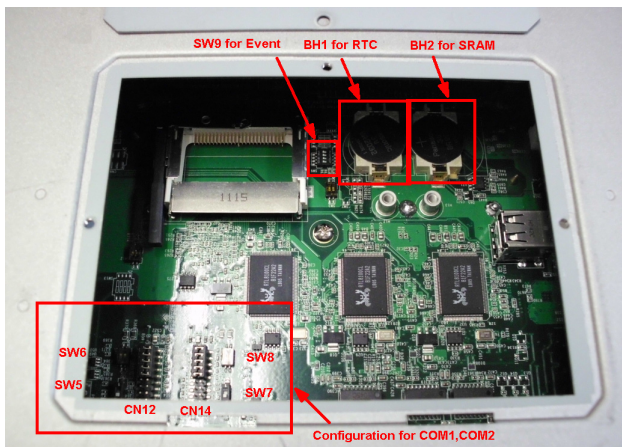
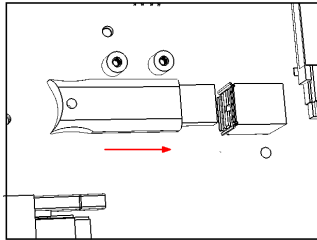

Figure 3.1: Location for Configuration

3.2 Install a USB Dongle

UNO-4683 provides a clamp to fix the USB dongle which can be installed inside the chassis. Please follow the steps to install the USB dongle and clamp:

1. Please follow 3.1 to open the cover for configuration.
2. Plug the USB Dongle in the upside port, please note the downside port is a dummy port.



Adjust the position of the kit to fasten the USB dongle, and then screw to fix the kit.

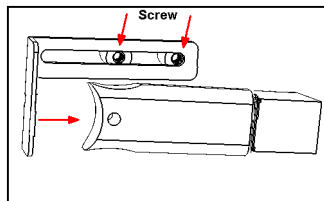

3.3 Install a Hard Disk

Please follow the steps below to install an HDD:

1. Turn the heat-sink side down.
2. Unscrew the screws and get the HDD bay apart.

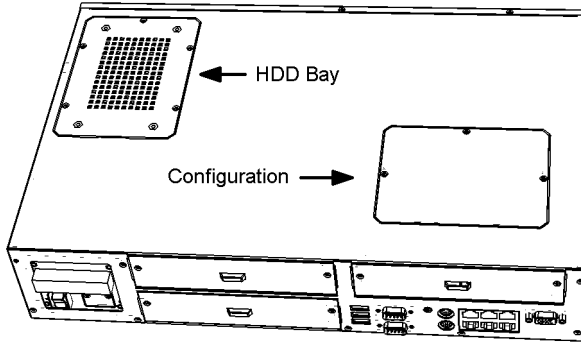

3. Insert the HDD into the HDD bay and screw it.

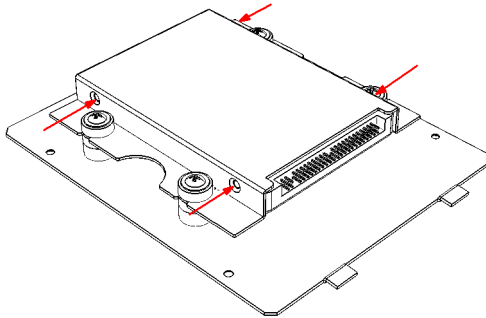

4. Connect the SATA cable between HDD and connector then assemble the HDD back to the chassis. The locations of the connectors are below HDD Bay.

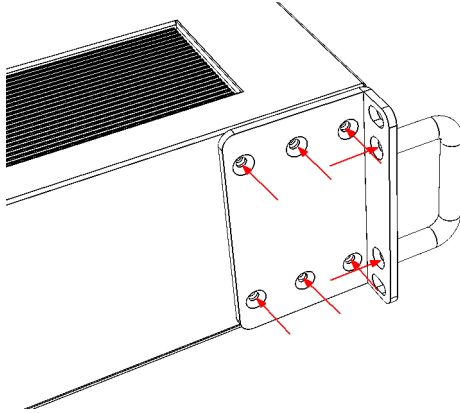

Figure 3.2: Location of SATA connections

3.4 Installing in a Rack

UNO-4683 provides the kits for Rack mounting in the accessory box

1. Please screw the ears and handles at the position indicated below.
The same on the other side.



2. Use the 4 screw holes to mount the UNO-4683 on the rack.

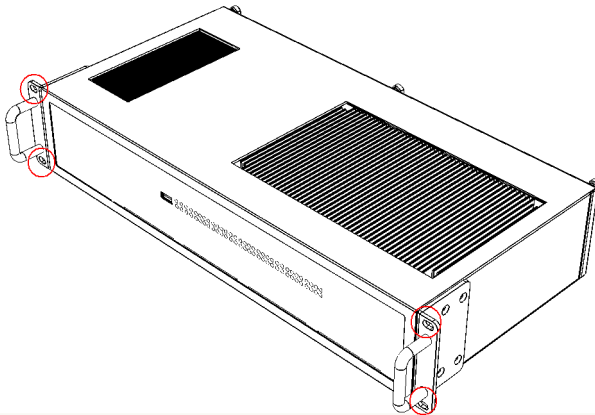

3. UNO-4683 equips the Aluminum Fins on the top of the unit as heat-sink. It can generate nature convection for better heat transmission. For optimal thermal performance, leave 2U (88.9mm) space height on the top of the unit.

3.5 BIOS Setup and System Assignments

UNO-4683 adopts Advantech's SOM-5788 CPU module.

Further information about the SOM module, can be found in SOM's user's manual. You can find this manual on the UNO-4683's companion DISC.

Please note that you can try to "LOAD BIOS DEFAULTS" from the BIOS Setup manual if the UNO-4683 does not work properly.

Appendix

A

System Settings and Pin Assignments

Appendix A System Settings & Pin Assignments

A.1 System I/O Address & Interrupt Assignments

Table A.1: UNO-4683 System I/O Ports

Address Range	Device
000-01F	DMA controller (slave)
020-03F	Interrupt controller 1, (master)
040-05F	8254 timer/counter
060-06F	8042 (keyboard controller)
070-07F	Real-time clock, non-maskable interrupt (NMI)mask
080-09F	DMA page register,
0A0-0BF	Interrupt controller 2 (slave)
0C0-0DF	DMA controller (master)
0F0	Clear math co-processor
0F1	Reset math co-processor
0F8-0FF	Math co-processor
1F0-1F8	1st fixed disk
200-218	Digital inputs, outputs and counter
278-27F	Reserved
2F8-2FF	Serial port 2 (reserved)
380-38F	SDLC, bisynchronous 2
3A0-3AF	Bisynchronous 1
3B0-3BF	Monochrome display
3C0-3CF	Reserved
3D0-3DF	Color/graphics monitor adapter
3F0-3F7	Diskette controller
3F8-3FF	Serial port 1 (reserved)

Table A.2: UNO-4683 Interrupt Assignment

Interrupt No.	Interrupt Source
NMI	Parity error detected
IRQ 0	Interval timer
IRQ 1	Keyboard
IRQ 2	Interrupt from controller 2 (cascade)
IRQ 8	Real-time clock
IRQ 11	Reserved for watchdog timer
IRQ 12	PS/2 mouse
IRQ 13	INT from co-processor
IRQ 14	Primary IDE

A.2 RS-232/422/485 Serial Ports (COM1~COM2)

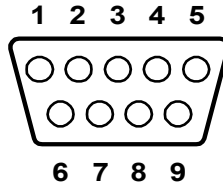

Table A.3: RS-232 Serial Ports COM1~2

Pin	RS-232	RS-422	RS-485
1	DCD	TX-	DATA-
2	RxD	TX+	DATA+
3	TxD	RX+	
4	DTR	RX-	
5	GND	GND	GND
6	DSR		
7	RTS		
8	CTS		
9	RI		

A.3 USB Connectors

Table A.4: USB Connector Pin Assignments

Pin	Signal name	Cable Color
1	VCC	Red
2	DATA-	White
3	DATA+	Green
4	GND	Black

A.4 DVI-I Connector

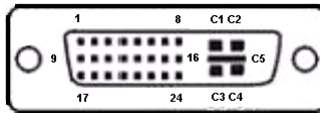

Table A.5: DVI Connector Pin Assignments

Pin	Signal Name
1	TMDS_C2#
2	TMDS_C2
3	GND
4	CRT_DDC_CLK
5	CRT_DDC_DATA
6	MDVI_CLK
7	MDVI_DATA
8	VGAVSY
9	TMDS_C1#
10	TMDS_C1
11	GND
12	-
13	-
14	VCC_DVI
15	VGA Detect
16	HP_DET

Table A.5: DVI Connector Pin Assignments

17	TMDS_C0#
18	TMDS_C0
19	GND
20	-
21	-
22	GND
23	TMDS_CK#
24	TMDS_CK
C1	VGAR
C2	VGAG
C3	VGAB
C4	VGHSY
C5	GND

A.5 SATA Hard Drive RAID Support

In order to install an operating system onto a RAID volume, the RAID option must be enabled in the system BIOS, a RAID volume must be created, and the F6 installation method must be used to load the Intel Rapid Storage Technology driver during operating system setup.

Before you start, please make sure that two SATA hard drives have been mounted in system. A USB floppy will be also required for some additional files.

Enable RAID in System BIOS

Use the instructions included with your motherboard to enable RAID in the system BIOS.

1. Click Del to enter the BIOS Setup program after the Power-On-Self-Test (POST) memory test begins.
2. Click the Integrated Peripherals menu.
3. Click the OnChip IED Device menu.
4. Switch the SATA Mode option to RAID to enable Intel? RAID Technology.
5. Click F10 to save the BIOS settings and exit the BIOS Setup program.

Create a RAID Volume

Use the following steps to create a RAID volume.

1. When the Intel Rapid Storage Technology option ROM status screen appears during POST, press Ctrl and i at the same time to enter the option ROM user interface.

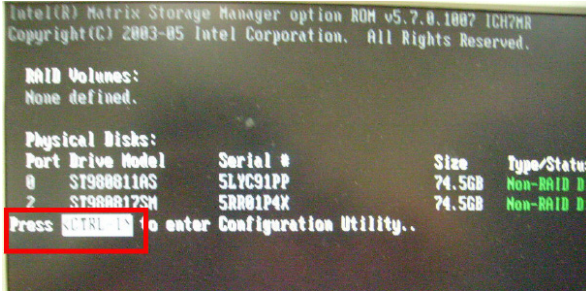

2. Select 1: Create RAID Volume and press Enter.

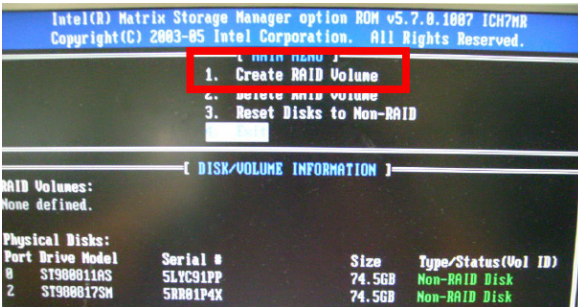

3. Use the up or down arrow keys to select the RAID level and press Enter.

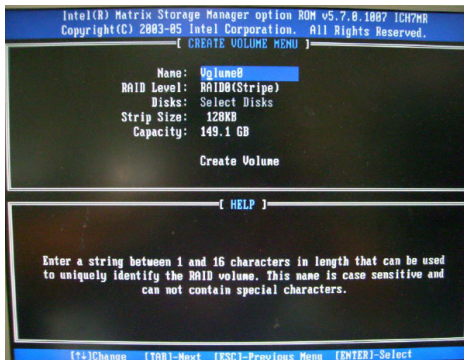

4. Unless you have selected RAID 1, use the up or down arrow keys to select the strip size and press Enter.
5. Press Enter to select the physical disks.
6. Select the appropriate number of hard drives by using the up or down arrow keys to scroll through the list of hard drives and press Space to select the drive. When finished press Enter.

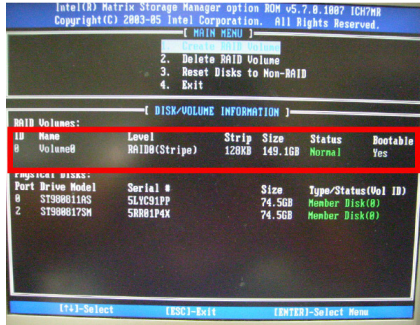

7. Select the volume size and press Enter.
8. Press Enter to create the volume.
9. At the prompt press Y to confirm volume creation.
10. Select 4: Exit and press Enter.
11. Press Y to confirm your exit.

Install the RAID Driver Using the F6 Installation Method

Perform the following steps to install the Intel Rapid Storage Technology driver during operating system setup:

1. Press F6 when you see a message in the status line that says, Press F6 if you need to install a third party SCSI or RAID driver. This message appears at the beginning of Windows XP* setup (during text-mode phase).

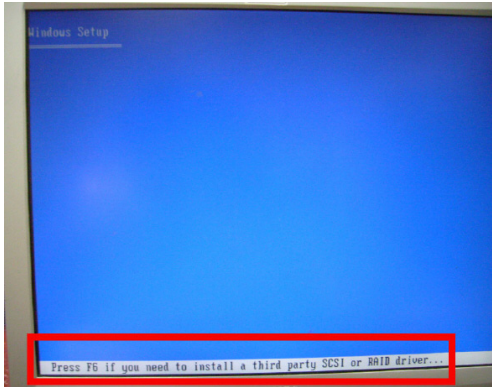

Note: Nothing will happen immediately after pressing F6. Setup will temporarily continue loading drivers. You will then be prompted with a screen asking you to load support for mass storage device(s).

2. Press S to Specify Additional Device.

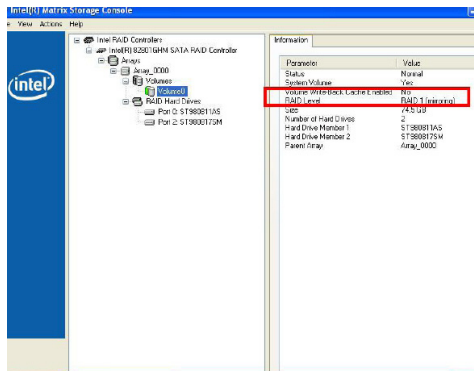

- When you see a prompt that says, Please insert the disk labeled Manufacturer-supplied hardware support disk into Drive A.; insert a floppy disk containing the following files: IAAHCI.INF, IAAHCI.CAT, IASTOR.INF, IASTOR.CAT, IASTOR.SYS, and TXTSETUP.OEM.

Note: Use the Floppy Configuration Utility to create a floppy disk with the necessary files or copy required file from driver folder.

- Press Enter.
- Select your controller from the list of available SCSI adapters. Use the up and down arrow keys to scroll through the list as all controllers may not be visible.
- Press Enter to confirm your controller and continue. At this point, you have successfully installed the driver and Windows setup should continue. Leave the floppy disk in the floppy drive until the system reboots. Windows setup will need to copy the files again from the floppy to the Windows installation folders. Once Windows setup has copied these files again, remove the floppy disk so that Windows setup can reboot as needed.
- During Windows setup, create a partition and file system on the RAID volume as you would on any physical disk.

Note: If you wish to use the Intel Rapid Storage Technology user interface in Windows, you will need to install Intel Rapid Storage Technology by running the Setup.exe process after these steps have been completed and the operating system has been successfully installed.

