

UNO-2059GL

**LX800 500MHz Automation Computer
with LAN, 2 x USB, 2 x RS-232/485,
2 x RS-232/422/485**

User Manual

Copyright

The documentation and the software included with this product are copyrighted 2010 by Advantech Co., Ltd. All rights are reserved. Advantech Co., Ltd. reserves the right to make improvements in the products described in this manual at any time without notice. No part of this manual may be reproduced, copied, translated or transmitted in any form or by any means without the prior written permission of Advantech Co., Ltd. Information provided in this manual is intended to be accurate and reliable. However, Advantech Co., Ltd. assumes no responsibility for its use, nor for any infringements of the rights of third parties, which may result from its use.

Acknowledgements

Intel and Pentium are trademarks of Intel Corporation.

Microsoft Windows and MS-DOS are registered trademarks of Microsoft Corp.

All other product names or trademarks are properties of their respective owners.

Part No. 2003205920

2nd Edition

Printed in Taiwan

October 2010

Product Warranty (2 years)

Advantech warrants to you, the original purchaser, that each of its products will be free from defects in materials and workmanship for two years from the date of purchase.

This warranty does not apply to any products which have been repaired or altered by persons other than repair personnel authorized by Advantech, or which have been subject to misuse, abuse, accident or improper installation. Advantech assumes no liability under the terms of this warranty as a consequence of such events.

Because of Advantech's high quality-control standards and rigorous testing, most of our customers never need to use our repair service. If an Advantech product is defective, it will be repaired or replaced at no charge during the warranty period. For out-of-warranty repairs, you will be billed according to the cost of replacement materials, service time and freight. Please consult your dealer for more details.

If you think you have a defective product, follow these steps:

1. Collect all the information about the problem encountered. (For example, CPU speed, Advantech products used, other hardware and software used, etc.) Note anything abnormal and list any onscreen messages you get when the problem occurs.
2. Call your dealer and describe the problem. Please have your manual, product, and any helpful information readily available.
3. If your product is diagnosed as defective, obtain an RMA (return merchandize authorization) number from your dealer. This allows us to process your return more quickly.
4. Carefully pack the defective product, a fully-completed Repair and Replacement Order Card and a photocopy proof of purchase date (such as your sales receipt) in a shippable container. A product returned without proof of the purchase date is not eligible for warranty service.
5. Write the RMA number visibly on the outside of the package and ship it prepaid to your dealer.

Declaration of Conformity

CE

This product has passed the CE test for environmental specifications when shielded cables are used for external wiring. We recommend the use of shielded cables. This kind of cable is available from Advantech. Please contact your local supplier for ordering information.

FCC Class A

Note: This equipment has been tested and found to comply with the limits for a Class A digital device, pursuant to part 15 of the FCC Rules. These limits are designed to provide reasonable protection against harmful interference when the equipment is operated in a commercial environment. This equipment generates, uses, and can radiate radio frequency energy and, if not installed and used in accordance with the instruction manual, may cause harmful interference to radio communications. Operation of this equipment in a residential area is likely to cause harmful interference in which case the user will be required to correct the interference at his own expense.

Technical Support and Assistance

Step 1. Visit the Advantech web site at **www.advantech.com/support** where you can find the latest information about the product.

Step 2. Contact your distributor, sales representative, or Advantech's customer service center for technical support if you need additional assistance. Please have the following information ready before you call:

- Product name and serial number
- Description of your peripheral attachments
- Description of your software (operating system, version, application software, etc.)
- A complete description of the problem
- The exact wording of any error messages

Contents

Chapter 1	Overview	2
1.1	Introduction	2
1.2	Hardware Specifications	2
1.3	Safety Precautions	4
1.4	Packing List	4
1.5	Chassis Dimensions	5
	Figure 1.1:Chassis Dimensions	5
Chapter 2	Hardware Functionality	8
2.1	UNO-2059GL Peripherals.....	8
	Figure 2.1:UNO-2059GL Front Panel	8
	Figure 2.2:UNO-2059GL Rear Panel	8
2.2	COM1~COM2: RS-232/485 Interfaces	8
	Table 2.1:COM1 & COM2 Default Settings	8
2.3	COM3~COM4: RS-232/422/485 Interfaces	9
	Table 2.2:COM3 & COM4 Default Settings	9
2.4	LAN: Ethernet Connector	10
2.5	Power Connector	10
2.6	LED Indicators	10
2.7	PS/2 Keyboard and Mouse Connector	10
2.8	USB1 & USB2: Universal Serial Bus Connectors.....	10
2.9	VGA: VGA Display Connector	11
2.10	Programmable LED & Buzzer	11
	Table 2.3:LED & Buzzer Control Register Bit Map ...	11
	Table 2.4:Programmable LED Control Bit	11
	Table 2.5:Programmable Buzzer Control Bit	12
2.11	Reset: Reset Button	12
Chapter 3	Initial Setup.....	14
3.1	Inserting CompactFlash Card	14
3.2	Chassis Grounding	14
	Figure 3.1:Chassis Grounding Connections	14
3.3	Connect the Power	15
3.4	BIOS Setup and System Assignments	15
Appendix A	Pin Assignments	18
A.1	Board Connectors & Jumpers	18
	Figure A.1:Connector & Jumper Locations (Top)	18
	Figure A.2:Connector & Jumper Locations (Bottom) ..	18
	Table A.1:UNO-2059GL Connectors & Jumpers	19
A.2	RS-232/485 Serial Port (CN13~CN14).....	20
	Table A.2:RS-232/485 Serial Port Pin Assigns	20
	Figure A.3:COM Port Terminator Resistor Locations ..	21
	Figure A.4:Terminator Resistor Installation	21
	Figure A.5:RS-485 Wiring Topology	22
	Table A.3:Jumpers to Select RS-232/485	22
	Figure A.6:RS-232 Jumper Settings	23

	Figure A.7:RS-485 Jumper Settings	23
A.3	RS-232/422/485 Serial Port (CN15~CN16)	23
	Table A.4:RS-232/422/485 Serial Port Pin Assigns	23
	Figure A.8:COM 3&4 Port Terminator Resistors	24
	Table A.5:RS-422 Terminal Resistors (COM3&4)	24
	Table A.6:RS-485 Terminal Resistors (COM3&4)	24
	Figure A.9:Terminator Installation	25
	Table A.7:Selecting RS-232/422/485 (COM3&4)	25
	Figure A.10:RS-422/485 Jumper Settings	25
	Figure A.11:RS-232 Jumper Settings	25
	Table A.8:Auto Flow Control & Master/Slave Mode ..	26
A.4	Ethernet RJ-45 Connector (LAN1)	27
	Table A.9:Ethernet RJ-45 Connector Pin Assigns	27
A.5	Phoenix Power Connector (CN1).....	27
	Table A.10:Phoenix Power Connector Pin Assigns	27
A.6	5V Power Output Connector (CN2).....	27
A.7	PS/2 Keyboard & Mouse Connector (CN10).....	28
	Table A.11:Keyboard & Mouse Pin Assigns	28
A.8	USB Connector (CN11, CN12).....	28
	Table A.12:USB Connector Pin Assigns	28
A.9	VGA Display Connector (CN7).....	29
	Table A.13:VGA Adaptor Cable Pin Assigns	29
A.10	CompactFlash Master/SlaveJumper Setting (JP1)	30
A.11	Enhanced IDE Connector (CN4).....	30

Overview

This chapter gives background information on the UNO-2059GL. It shows you the UNO-2059GL overview and specifications.

Sections include:

- Introduction
- Hardware Specifications
- Safety Precautions
- UNO-2059GL Series

Chapter 1 Overview

1.1 Introduction

Leveraging field-approved and worldwide-awareness real-time OS technology, Advantech UNO-2000 series provide Windows CE & XPe SP2 ready solution, and support several standard networking interfaces, such as Ethernet, Wireless LAN, RS-232/422/485 and so on. Because of its openness, great expansion capability and reliable design – fanless and diskless, Advantech UNO-2000 series are ideal embedded platforms to implement custom applications in diversified applications.

1.2 Hardware Specifications

- **CPU:** AMD Geode LX800 500MHz
- **Chipset:** AMD CS5536
- **BIOS:** AWARD 4Mbit FLASH BIOS
- **RAM:** 256MB DDR RAM on board
- **VGA:** Supports VGA and VESA
 - Display memory: 1 ~ 16 MB share memory, set in BIOS
 - CRT display mode: Non-interlaced CRT monitors resolutions up to 1280 x 1024 @ 256 colors or 1024 x 768 @ 24 bpp
 - DB-15 and Mini 6-pin VGA connector
- **Serial Port:** Two RS-232/485 ports (COM1 and COM2)
Two RS-232/422/485 ports (COM3 and COM4)
 - Controller: Oxford OX16PCI954 UARTs with 128 bytes FIFOs
 - IRQ: All ports use the same IRQ assigned by BIOS
 - Space reserved for termination resistors
 - Automatic RS-485 data flow control
 - RS-422/485 surge protection up to 2,000 V_{DC}
 - Data bits: 5, 6, 7, 8
 - Stop bits: 1, 1.5, 2
 - Parity: none, even, odd
 - RS-232 speed: 50 ~ 115.2 Kbps

- RS-422/485 speed: 50 ~ 921.6Kbps
- RS-232 data signals: TxD, RxD, RTS, CTS, DTR, DSR, DCD, RI, GND
- RS-422 data signals: TxD+, TxD-, RxD+, RxD-, GND
- RS-485 data signal: DATA+, DATA-, GND
- RS-232 max data distance: 50 feet (15.2 meters)
- RS-422/485 max data distance: 4000 feet (1220 meters)
- **USB Interface:** Two USB ports, USB EHCI, Rev. 2.0 compliant
- **Ethernet Port:** One 10/100Base-T Ethernet
 - LAN chip: Realtek 8100BL chipset supports
 - LED on the front side
- **SSD:** 1 Type I / Type II CompactFlash card slot inside the chassis
- **HDD:** Offers HDD extension kit for installation of 1 x 2.5" HDD.
- **LED:** One power LED, one IDE LED, one programmable LED and one programmable buzzer
- **Keyboard/Mouse Connector:** Mini-DIN connector supports PS/2 keyboard and a PS/2 mouse
- **Power Supply Voltage:** 18 ~ 48 V_{DC} , reversed wiring protection
- **Power Consumption:** 0.6A max under +24V power input or 1.2A max. under +12V power input
- **Power Requirement:** 1A typical under +24 V power input or 1.5 A typical under +12 V power input
- **Operating Temperature:** -10 ~ 55° C (14 ~ 131°F)
- **Chassis Size (WxLxH):** 164.8 x 106.5 x 35.5 mm (6.5" x 4.2" x 1.4")
- **Weight:** 0.8 kg

1.3 Safety Precautions

The following sections tell how to make each connection. In most cases, you will simply need to connect a standard cable. All of the connector pin assignments are shown in Appendix A.

Warning! *Always disconnect the power cord from your chassis whenever you are working on it. Do not connect while the power is on. A sudden rush of power can damage sensitive electronic components. Only experienced electronics personnel should open the chassis.*

Caution! *Always ground yourself to remove any static electric charge before touching UNO-2041. Modern electronic devices are very sensitive to static electric charges. Use a grounding wrist strap at all times. Place all electronic components on a static-dissipative surface or in a static-shielded bag.*

1.4 Packing List

Before installing, make sure that you have the following materials:

- **UNO-2059GL:** UNO-2059GL hardware platform
- Warranty certificate
- Software Supporting CD-ROM
- 6P-6P-6P 20cm KB and PS/2 Mouse Y cable (P/N: 1700060202)
- Plug-in Block 2P Female (P/N 1652002205)
- 6P-15P 10cm VGA cable (P/N: 1703150101)
- DIN-rail mounting accessory (1997001110, 1997001120, 1997001130, 1997001140)

If any of these items are missing or damaged, contact your distributor or sales representative immediately.

1.5 Chassis Dimensions

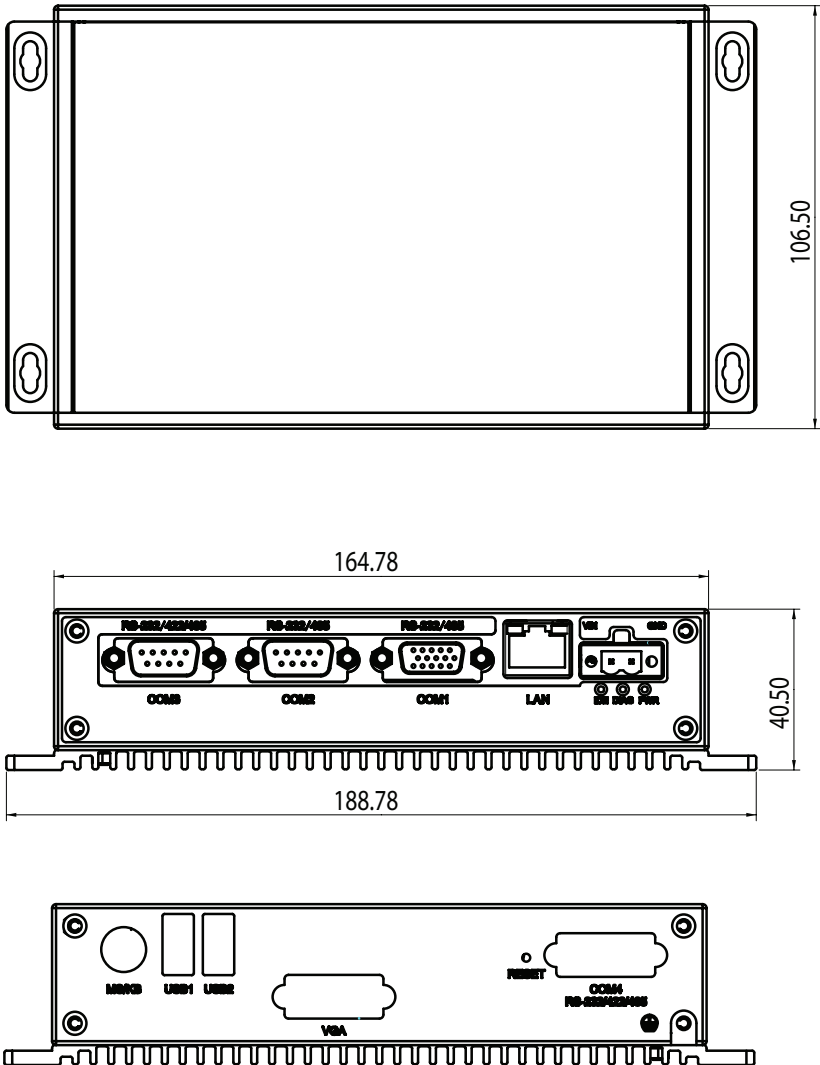

Figure 1.1: Chassis Dimensions

Hardware Functionality

This chapter shows how to set up the UNO-2059GL's hardware functions, including connecting peripherals, switches and indicators.

Sections include:

- UNO-2059GL Peripherals
- COM1&2: RS-232/485 Interfaces
- COM3&4: RS-232/422/485
- LAN: Ethernet Connector
- Power Connector
- LED Indicators
- PS/2 Keyboard and Mouse Connector
- USB1 & USB2
- VGA: VGA Display Connector
- Programmable LED and Buzzer
- RESET: Reset Button

Chapter 2 Hardware Functionality

2.1 UNO-2059GL Peripherals

The following two figures show the connectors on UNO-2059GL. The following sections give you detail information about function of each peripheral.

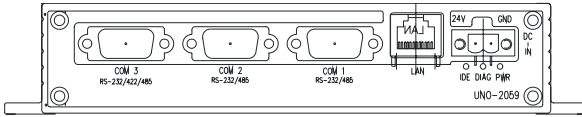

Figure 2.1: UNO-2059GL Front Panel

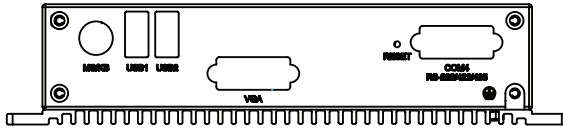

Figure 2.2: UNO-2059GL Rear Panel

2.2 COM1~COM2: RS-232/485 Interfaces

The UNO-2059GL offers two RS-232/485 serial communication interface ports, and they are COM1 and COM2. Each port can be configured individually to either RS-232 or RS-485 using on-board jumpers (see Appendix A.2), and Table 2-1 lists the default setting of serial ports.

Table 2.1: COM1 & COM2 Default Settings

COM Port	Default Setting
COM1	RS-232
COM2	RS-232

2.3 COM3~COM4: RS-232/422/485 Interfaces

The UNO-2059GL offers two RS-232/422/485 serial communication interface port, and they are COM3 and COM4. Each port can be configured individually to either RS-232, RS422/485 by using on-board jumpers. (See Appendix A.3) and Table 2-2 lists the default setting of each port.

Table 2.2: COM3 & COM4 Default Settings

COM Port	Default Setting
COM3	RS-422/485
COM4	RS-422/485

16C954 UARTs with 128-byte standard

Advantech UNO-2059GL comes standard with Oxford OX16PCI964 UARTs containing 128 bytes FIFOs. These upgraded FIFOs greatly reduce CPU overhead and are an ideal choice for heavy multitasking environments.

Jumpless for RS-422/485

In RS-422/485 mode, UNO-2059GL automatically sense signals to match RS-422 or RS-485 network.

Automatic Data Flow Control Function for RS-485

In RS-485 mode, UNO-2059GL automatically senses the direction of incoming data and switches its transmission direction accordingly. Therefore no handshaking signal (e.g. RTS signal) is necessary. This feature lets you simply and quickly build an RS-485 network with just two wires. More importantly, application software previously written for half duplex RS-232 environments can be maintained without need for modification.

IRQ and Address Setting

The IRQ and I/O address range are both assigned by BIOS, and four serial ports use the same IRQ.

2.4 LAN: Ethernet Connector

The UNO-2059GL is equipped with Realtek RTL8100BL Ethernet LAN controller that is fully compliant with IEEE 802.3u 10/100Base-T CSMA/CD standards. The Ethernet port provides a standard RJ-45 jack on board, and LED indicators on the front side to show its Link (Yellow LED) and Active (Green LED) status.

2.5 Power Connector

The UNO-2059GL comes with a Phoenix connector that carries 18~48 V_{DC} external power input, and features reversed wiring protection. Therefore, it will not cause any damage to the system by reversed wiring of ground line and power line.

2.6 LED Indicators

There are three LEDs on the UNO-2059GL front panel for indicating system status: PWR LED is for power status, DIAG LED is programmable by user's requirement and IDE LED is for IDE bus status.

2.7 PS/2 Keyboard and Mouse Connector

The UNO-2059GL provides a PS/2 keyboard and PS/2 mouse connector. A 6-pin mini-DIN connector is located on the rear panel of the UNO-2059GL. The UNO-2059GL comes with an adapter to convert from the 6-pin mini-DIN connector to two 6-pin mini-DIN connectors for PS/2 keyboard and PS/2 mouse connection. Please refer to Appendix A.6 for its pin assignments.

2.8 USB1 & USB2: Universal Serial Bus Connectors

The USB connector is used for connecting any device that conforms to the USB interface. Many recent digital devices conform to this standard. The USB interface supports Plug & Play, which enables you to connect or disconnect a device whenever you want without turning off the computer.

The UNO-2059GL provides two connectors of USB interfaces, which gives complete Plug & Play and hot swapping for up to 127 external devices. The USB interface complies with USB specification USB EHCI, Rev. 2.0. The USB interface can be disabled in the system BIOS setup.

2.9 VGA: VGA Display Connector

The UNO-2059GL provides a VGA controller for a high resolution VGA interface. It supports VGA and VESA, up to 1280 x 1024 @ 8 bpp and 1024 x 768 @ 24bpp resolution and up to 16 MB share memory. The VGA interface is reserved for system testing and debugging.

2.10 Programmable LED & Buzzer

In headless application (an application without monitor display), it is always a big problem to know the system status. Another PC may be needed to monitor headless device status via RS-232 or Ethernet. In order to solve this problem, UNO-2059GL offers a programmable LED indicator and buzzer. Hence, they can be programmed to show a system's status by LED indicator flickering and buzzer alarm.

Table 2.3: LED & Buzzer Control Register Bit Map

Base+62H	R/W	LED Control Register					
					LEDS1	LEDS0	LEDEn
Base+63H	R/W	Buzzer Control Register					
					SPKS1	SPKS0	SPKEn

LED and Buzzer Control Register

LEDEn: Enable LED flickering

LEDS0 and LEDS1: LED flickering speed setting bit

SPKEn: Enable buzzer alarming

SPKS0 & SPKS1: Buzzer alarming setting bit

Table 2.4: Programmable LED Control Bit

LED Flickering Status	LEDS1	LEDS2
Light on	0	0
Fast flicker	0	1
Normal flicker	1	0
Short flicker	1	1

Table 2.5: Programmable Buzzer Control Bit

Buzzer Alarm	SPKS1	SPKS0
Beep on	0	0
Short beep	0	1
Normal beep	1	0
Long beep	1	1

2.11 Reset: Reset Button

Press the "Reset" button to activate a reset function.

Initial Setup

This chapter shows how to initialize the UNO-2059GL, sections include:

Sections include:

- Inserting the CompactFlash Card
- Chassis grounding
- Connecting the Power
- BIOS Setup and System Assignments

Chapter 3 Initial Setup

3.1 Inserting CompactFlash Card

The procedure for installing a CompactFlash card into the UNO-2059GL is as follow, please follows these steps carefully.

Step 1: Remove the power cord.

Step 2: Unscrew four screws from the rear panel of the UNO-2059GL.

Step 3: Remove the rear panel.

Step 4: Plug a CompactFlash card with user’s OS and application program into a CompactFlash card slot on board.

Step 5: Screw back the rear panel with four screws.

3.2 Chassis Grounding

The aluminum made UNO-2059GL provides good EMI protection and stable system grounding base. There is an easy-to-connect chassis grounding point for you to connect to the “Earth.” Users can select if connecting power grounding with chassis grounding with an onboard jumper selection.

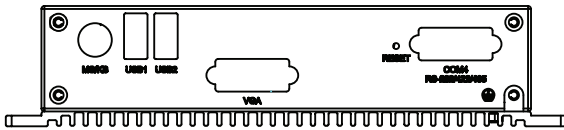
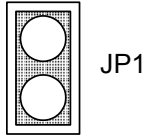

Figure 3.1: Chassis Grounding Connections

UNO-2059GL has onboard jumper JP1 to select if connecting chassis ground with system's power ground.

Connecting Chassis Ground with System Power Ground: (Default)



Not Connecting Chassis Ground with System Power Ground:

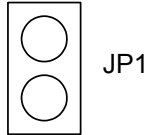

3.3 Connect the Power

Connect the UNO-2059GL to a 18~48 V_{DC} power source. The power source can either be from a power adapter or an in-house power source.

3.4 BIOS Setup and System Assignments

UNO-2059GL adopts Advantech SOM-2355 CPU module. For UNO-2059GL BIOS setup and system assignments, you can refer to SOM-2355 Chapter 4 “Award BIOS Setup” and Appendix A “System Assignments” for detailed information. The SOM-2355 user’s manual is located under “Manual” folder on the CD-ROM.”

Please note that you can try to “LOAD BIOS DEFAULTS” from BIOS Setup manual if the UNO-2059GL does not work properly.

Pin Assignments

This appendix gives the UNO-2059GL pin assignments

Sections include:

- Board Connectors & Jumpers
- RS-232/485 Serial Port
- RS-232/422/485 Serial Port
- Ethernet RJ-45 Connector
- Phoenix Power Connector
- 5V Power Output Connector
- PS/2 Keyboard and Mouse Connector
- USB Connector
- VGA Display Connector
- CompactFlash Master/Slave Jumper
- Enhanced IDE Connector

Appendix A Pin Assignments

A.1 Board Connectors & Jumpers

There are connectors and jumpers on the UNO-2059GL board. The following sections tell you how to configure the UNO-2059GL hardware setting. Figure A-1 and figure A-2 show the locations of UNO-2059GL connectors and jumpers.

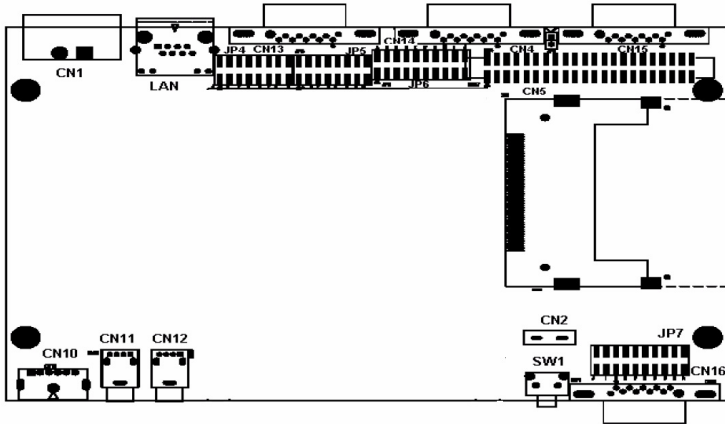

Figure A.1: Connector & Jumper Locations (Top)

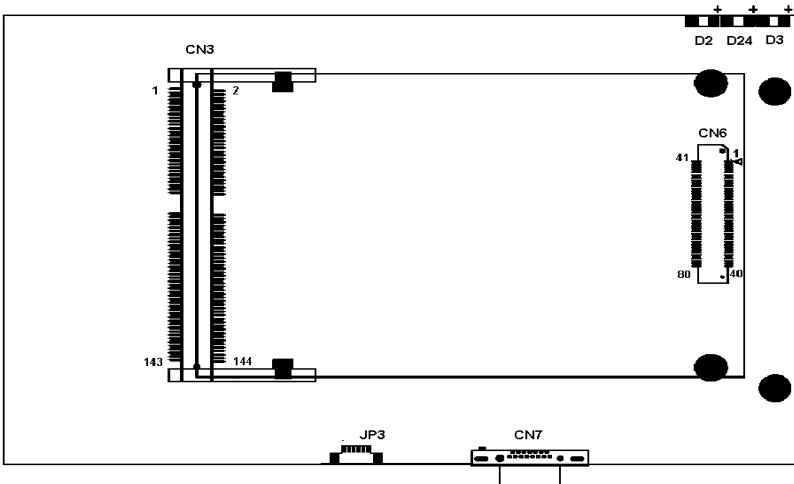

Figure A.2: Connector & Jumper Locations (Bottom)

Table A.1: UNO-2059GL Connectors & Jumpers

CN1	Phoenix power connector
CN2	5V power output connector
CN4	Internal IDE connector
CN5	Internal CompactFlash card slot
CN7	VGA DB15 display connector
CN8	RS-232 serial port (reserved)
CN9	RS-232 serial port (reserved)
CN10	PS/2 keyboard and mouse connector
CN11	USB1 connector
CN12	USB2 connector
CN13	COM1 RS-232/485 serial port
CN14	COM2 RS-232/485 serial port
CN15	COM3 RS-232/422/485 serial port
CN16	COM4 RS-232/422/485 serial port
D2	IDE LED
D3	Power LED
SW1	Reset button
JP1	CompactFlash(tm) IDE Primary Master/Slave jumper
JP2	System grounding jumper
JP4	COM1 RS-232/485 selection
JP5	COM2 RS-232/485 selection
JP6	COM3 RS-232/422/485 selection
JP7	COM4 RS-232/422/485 selection
LAN1	Ethernet RJ45 connector

A.2 RS-232/485 Serial Port (CN13~CN14)

Pin Assignments

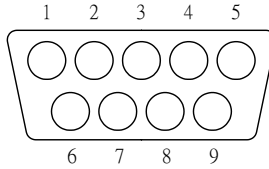

Table A.2: RS-232/485 Serial Port Pin Assigns

Pin	RS-232 Signal Name	RS-485 Signal Name
1	DCD	DATA-
2	RxD	DATA+
3	TxD	NC
4	DTR	NC
5	GND	GND
6	DSR	NC
7	RTS	NC
8	CTS	NC
9	RI	NC

Note: NC represents “No Connection.”

Terminator Resistors Setup for RS-485

The terminal resistors for impedance matching on the UNO-2059GL are not installed in the factory.

Users can install the resistors with the appropriate resistances according to the UNO-2059GL application. Each terminal resistor corresponds to a different channels for DATA+, DATA- lines. Usually, these resistors are needed for both ends of the communication wires and the value of the resistors should match the characteristic impedance of the wires used (approximately 120 Ω or 300 Ω). The TR1 and TR2 shown on Figure A-3 are prepared for COM1 and COM2 termination resistors respectively.

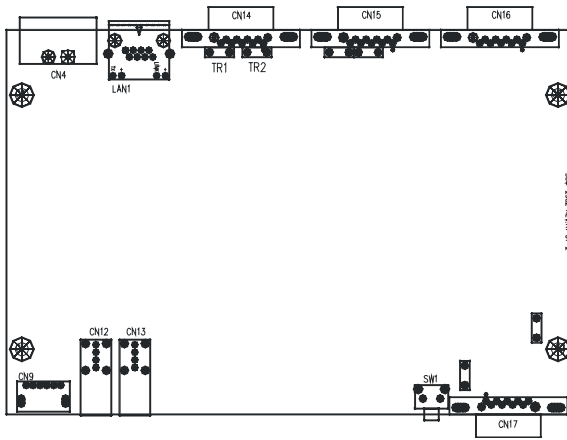

Figure A.3: COM Port Terminator Resistor Locations

An example of the installation of COM1 is as follows:

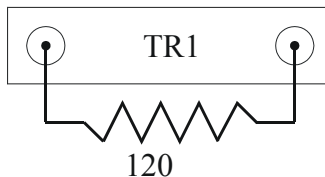

Figure A.4: Terminator Resistor Installation

RS-485 Signal Wiring

The RS-485 standard supports half-duplex communication. This means that just two wires are needed to both transmit and receive data. Handshaking signals (such as RTS, Request To Send) in RS-232 are normally used to control the direction of the data flow and to switch the transmission accordingly. In RS-485 mode, the UNO-2059GL automatically senses the direction of the data flow and switches the transmission direction - no handshaking is necessary. This means a user can build an RS-485 network with just two wires. This RS-485 control is completely transparent to the user. The software written for half duplex RS-232 works without the need for any modification.

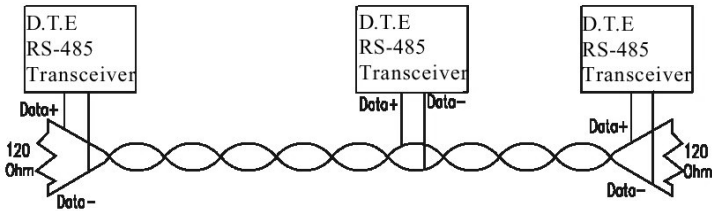

Figure A.5: RS-485 Wiring Topology

RS-232/485 Selection

COM1 and COM2 all support RS-232 and RS-485 interfaces, and you can set corresponding jumpers to select serial ports as RS-232 or RS-485 interfaces shown in Table A-3.

Table A.3: Jumpers to Select RS-232/485

Serial Port	Corresponding Jumper to Select RS-232/485
COM1	JP4
COM2	JP5

Jumper Setting for RS-232 Interface: (Default Setting)

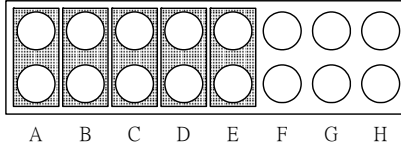

Figure A.6: RS-232 Jumper Settings

Jumper Setting for RS-485 Interface:

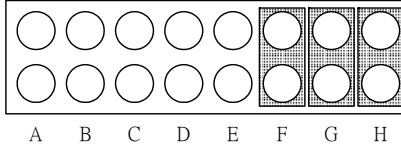

Figure A.7: RS-485 Jumper Settings

A.3 RS-232/422/485 Serial Port (CN15~CN16)

Pin Assignments

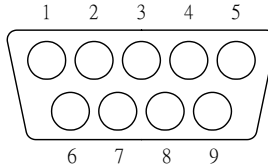

Table A.4: RS-232/422/485 Serial Port Pin Assigns

Pin	RS-232	RS-422	RS-485
1	DCD	Tx-	DATA-
2	RxD	Tx+	DATA+
3	TxD	Rx+	NC
4	DTR	Rx-	NC
5	GND	GND	GND
6	DSR	NC	NC
7	RTS	NC	NC
8	CTS	NC	NC
9	RI	NC	NC

Note: NC represents “No Connection”

Terminator Resistor Setup for RS-422/485

The terminal resistors for impedance matching on the UNO-2059GL are not installed in the factory. Users can install the resistors with the appropriate resistances according to the UNO-2059GL application. Each terminal resistor responds to different channels for RS-422/485 signal lines. Usually, these resistors are needed for both ends of the communication wires and the value of the resistors should match the characteristic impedance of the wires used (approximately 120 W or 300 W).

The TR3, TR4, TR5 and TR6 shown on Figure A-8 are prepared for COM3 and COM4 termination resistors respectively.

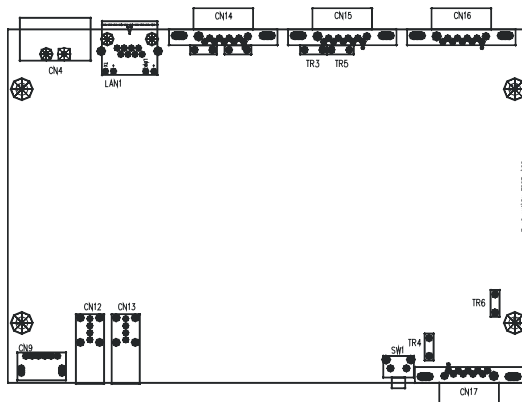

Figure A.8: COM 3&4 Port Terminator Resistors

Table A.5: RS-422 Terminal Resistors (COM3&4)

Serial Port	Terminal Resistor
COM3	TR3 (Tx+, Tx-)
COM3	TR5 (Rx+, Rx-)
COM4	TR4 (Tx+, Tx-)
COM4	TR6 (Rx+, Rx-)

Table A.6: RS-485 Terminal Resistors (COM3&4)

Serial Port	Terminal Resistor
COM3	TR3 (Data+, Data-)
COM4	TR4 (Data+, Data-)

An example of the installation of COM3 is as follows:

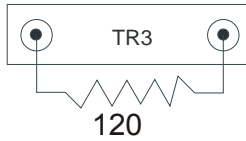

Figure A.9: Terminator Installation

RS-232/422/485 Selection

COM3 and COM4 support 9-wire RS-232, RS-422 or RS-485 interfaces, and you can set corresponding jumpers to select serial ports as RS-232 or RS-422/485 interfaces shown in Table A-7.

The system detects RS-422 or RS-485 signals automatically in RS-422/485 mode.

Table A.7: Selecting RS-232/422/485 (COM3&4)

Serial Port	Corresponding Jumper to Select RS-232/422/485
COM3	JP6
COM4	JP7

Jumper Setting for RS-422/485 Interface: (Default Setting)

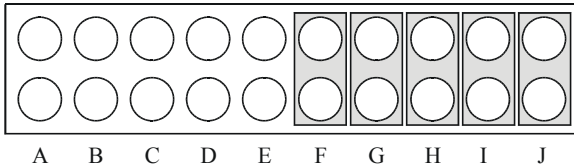

Figure A.10: RS-422/485 Jumper Settings

Jumper Setting for RS-232 Interfaces:

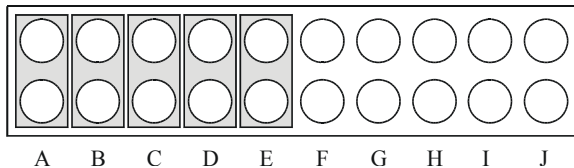

Figure A.11: RS-232 Jumper Settings

RS-485 Auto Flow Control and RS-422 Master/Slave Mode Selection

You set the “Auto Flow Control” mode of RS-485 or “Master/Slave” mode of RS-422 by using SW2 DIP switches for each RS-422/485 port.

In RS-485, if the switch is set to “Auto”, the driver automatically senses the direction of the data flow and switches the direction of transmission. No handshaking is necessary.

In RS-422, if DIP switch is set to “On,” the driver is always enabled, and always in high or low status.

Table A.8: Auto Flow Control & Master/Slave Mode

SW2 DIP Switch Setting	Description
<div style="border: 1px solid black; padding: 5px;"> 1 <input type="checkbox"/> On 2 <input type="checkbox"/> </div>	COM3 RS-485: Auto flow control; RS-422: Slave mode
	COM4 RS-485: Auto flow control; RS-422: Slave mode
<div style="border: 1px solid black; padding: 5px;"> 1 <input type="checkbox"/> On 2 <input type="checkbox"/> </div>	COM3 RS-485: N/A; RS-422: Master mode
	COM4 RS-485: Auto flow control; RS-422: Slave mode
<div style="border: 1px solid black; padding: 5px;"> 1 <input type="checkbox"/> On 2 <input type="checkbox"/> </div>	COM3 RS-485: Auto flow control; RS-422: Slave mode
	COM4 RS-485: N/A; RS-422: Master mode
<div style="border: 1px solid black; padding: 5px;"> 1 <input type="checkbox"/> On 2 <input type="checkbox"/> </div>	COM3 RS-485: N/A; RS-422: Master mode
	COM4 RS-485: N/A; RS-422: Master mode

A.4 Ethernet RJ-45 Connector (LAN1)

Ethernet RJ-45 Connector Pin Assignments

Table A.9: Ethernet RJ-45 Connector Pin Assigns

Pin	10/100Base-T Signal Name
1	XMT+
2	XMT-
3	RCV+
4	NC
5	NC
6	RCV-
7	NC
8	NC

A.5 Phoenix Power Connector (CN1)

Phoenix Power Connector Pin Assignments

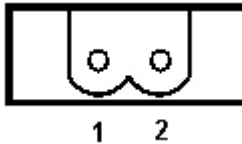

Table A.10: Phoenix Power Connector Pin Assigns

Pin	Signal Name
1	18 ~ 48 V _{DC}
2	GND

A.6 5V Power Output Connector (CN2)

This connector is used to output power for a specific device:

- Pin 1: 5V
- Pin 2: GND

A.7 PS/2 Keyboard & Mouse Connector (CN10)

PS/2 KB/MS Connector Pin Assignments

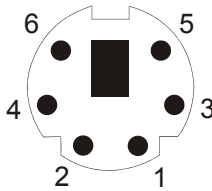

Table A.11: Keyboard & Mouse Pin Assigns

Pin	Signal Name
1	KB DATA
2	MS DATA
3	GND
4	VCC
5	KB CLOCK
6	MS CLOCK

A.8 USB Connector (CN11, CN12)

USB Connector Pin Assignments

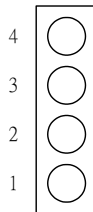

Table A.12: USB Connector Pin Assigns

Pin	Signal Name	Cable Color
1	VCC	Red
2	DATA-	White
3	DATA+	Green
5	GND	Black

A.9 VGA Display Connector (CN7)

VGA Adaptor Cable Pin Assignments

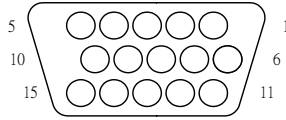

Table A.13: VGA Adaptor Cable Pin Assigns

Pin	Signal Name	Pin	Signal Name
1	RED	9	NC
2	GREEN	10	GND
3	BLUE	11	NC
4	NC	12	NC
5	GND	13	H-SYNC
6	GND	14	V-SYNC
7	GND	15	NC
8	GND		

Chipset

The UNO-2059GL uses a AMD CS5536 chipset for its SVGA controller. It supports interlaced and non-interlaced analog monitors (color and monochrome VGA) in high-resolution modes while maintaining complete IBM VGA compatibility. Digital monitors (i.e. MDA, CGA and EGA) are NOT supported. Multiple frequency (multisync) monitors are handled as if they were analog monitors.

Display memory

With 1 ~ 16 MB share memory, the VGA controller can drive CRT displays or color panel displays with resolutions up to 1024 x 768 at 24 bit. For 1024 x 768 color resolution, the display is expanded to 16 MB in BIOS.

A.10 CompactFlash Master/SlaveJumper Setting (JP1)

The CompactFlash interface uses a primary IDE channel, which could be set as the master or slave device by changing the setting of JP1.

Master Device: (Default)

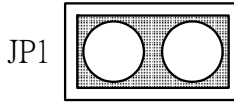

Slave Device:

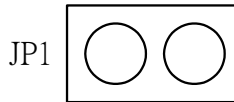

UNO-2059GL has one CompactFlash card slot in the chassis. It supports CompactFlash type I (3mm thick) and type II (5mm thick) cards. A 32 MB CompactFlash card is equipped in the UNO-2059GL. For UNO-2059GL, there is no CompactFlash card on the slot. UNO-2059GL also supports IBM Microdrive storage device, which is an ultra-miniature hard disk from IBM that was introduced in 1998. The Microdrive is built into a Type II CompactFlash form factor.

A.11 Enhanced IDE Connector (CN4)

You can attach two IDE (Integrated Device Electronics) drives to the UNO-2059GL for software installation or system testing. The UNO-2059GL has an EIDE connector, designated CN1. Wire number 1 on the cable is red or blue, and the other wires are gray. Connect one end to connector CN1 on the board. Make sure that the red (or blue) wire corresponds to pin 1 on the connector (on the right side). See “A.1 Board Connectors and Jumpers” earlier in this chapter for help in finding the connector. Unlike floppy drives, IDE hard drives can connect in either position on the cable. If you install two drives, you will need to set one as the master and one as the slave. You do this by setting the jumpers on the drives. If you use just one drive, you should set it as the master. See the documentation that came with your drive for more information. Connect the first hard drive to the other end of the cable. Wire 1 on the cable should also connect to pin 1 on the hard drive connector, which is labeled on the drive circuit board. Check the documentation that came with the drive for more information.