

SPC-1840WP

18.5" WXGA TFT LCD stationary
Multi-Touch Panel Computer
with AMD dual-core processor



product
design award

2013

NEW

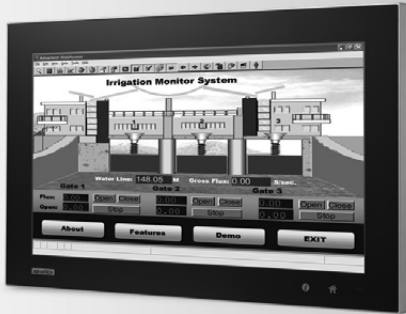

Features

- 18.5" WXGA TFT LED LCD display
- AMD dual-core 1.65GHz processor with independent GPU, advanced graphical performance
- 16:9 wide screen with PCT multi-touch
- Built-in function and home key button used for intuitive UI
- Anti-scratch touch surface: 7H hardness
- All around IP65 with waterproof M12 connector
- Support Mini-PCIe expansion slot
- Front LED indicator to show operating status
- Fanless cooling system
- Winner of the 2013 iF product design award

Introduction

With brand-new ID design, the SPC-1840WP series provide high resolution 18.5" display and PCT multi-touch in 16:9 wide format. By embedding an AMD T56N 1.65GHz processor with independent GPU, the SPC-1840WP can support advanced graphical performance in more complex applications. Built-in function and home key button for greater user usability and operating safety. The SPC-1840WP also supports Mini-PCIe slot for communication function expansion. Moreover, the SPC-1840WP includes an all around waterproof design with M12 connectors. With this vertical I/O connector, cable routing can be an easy job in stationary / VESA Arm applications.

Specifications

General

- **Certification** BSMI, CCC, CE, FCC Class A, UL
- **Cooling System** Fanless design
- **Dimensions (W x H x D)** 488 x 309 x 65mm (19.2" x 21.2" x 2.6")
- **Enclosure** Front bezel: Die-cast Aluminium alloy
Back housing: Die-cast Aluminium alloy
- **Mounting** VESA Arm
- **OS Support** Microsoft® Win8/WES7P/XP/WES2009/Linux
- **Power Consumption** 35 W Typical
- **Power Input** 24 V_{DC}
- **Weight (Net)** 8 kg (17.64 lbs)

System Hardware

- **CPU** AMD G-series T56N 1.65GHz
- **Chipset** AMD A50M FCH
- **Memory** 4GB SO-DIMM DDR3 SDRAM
- **LAN** 10/100/1000Base-T x 2 (connection:M12 A-coding, 8-pin female)
- **Expansion Slots** Full-sized Mini PCI-E x 1 (optional)
- **Storage** 2.5" SATA HDD
- **I/O** RS-232 x1 (connection:M12 A-coding, 8-pin male)
USB 2.0 x1 (connection:M12 A-coding, 8-pin female)
24 V_{DC} power input (connection:M12 A-coding, 5-pin male)

LCD Display

- **Display Type** WXGA TFT LED LCD
- **Display Size** 18.5"
- **Max. Resolution** 1366 x 768
- **Max. Colors** 16.7 M
- **Luminance cd/m²** 300
- **Viewing Angle (H/V°)** 170/160
- **Backlight Life** 50,000 hrs

Touchscreen

- **Light Transmission** ≥88%
- **Resolution** 4096*4096 dot
- **Type** Projected capacitive

Environment

- **Humidity** 10 ~ 95% RH @ 40°C, non-condensing
Note: Tested for 48hrs
- **Ingress Protection** All around IP65
- **Operating Temperature** 0 ~ 50°C (32 ~ 122°F)
- **Storage Temperature** -20 ~ 60°C (-4 ~ 140°F)
- **Vibration Protection** With HDD: 1 Grms (5 ~ 500 Hz)
(Operating, random vibration)

Dimensions

Unit: mm

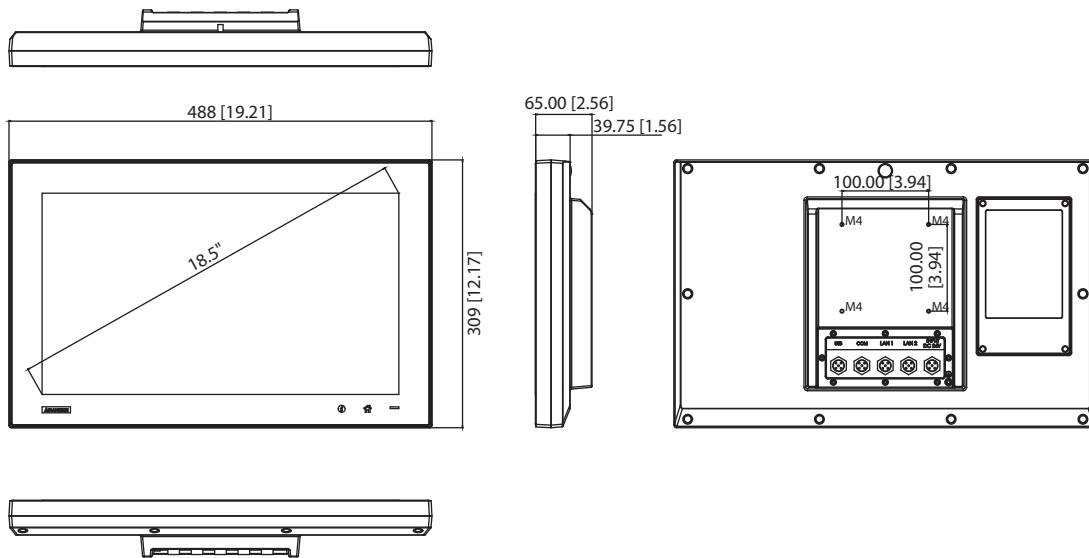

Ordering Information

- **SPC-1840WP-T3AE** 18.5" WXGA stationary Multi-Touch Panel PC, 4GB

Accessories

- **PWR-247-AE** 50W DC 24V/2.3A Output Power Supply
- **1702002605** Power cable EU Plug 1.8M
- **1702031801** Power cable UK Plug 1.8M
- **1702031836** Power cable China/Australia Plug 1.8M
- **EWM-W139F01E** 802.11 b/g/n, RT5390, 1T1R, Full-size Mini-PCle
- **1750000318** EMI Antenna 2DBI 2.4GHz SMA CONN for ARK-3384
- **1750003222** 802.11b/g 5dBi Dipole Antenna
- **1750003418** Wireless Antenna AN2400-5901RS R/P SMA.M9dB

Rear View

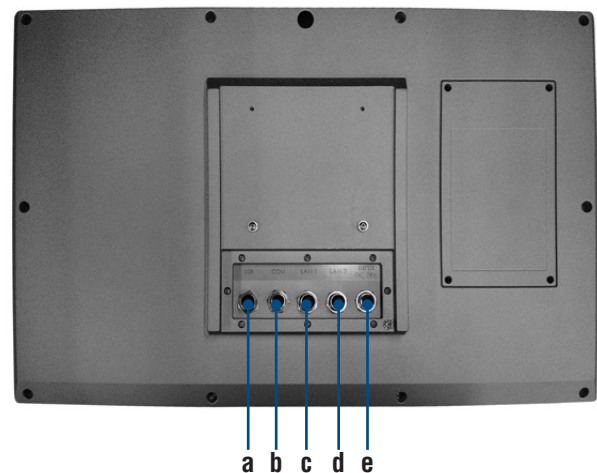

- a. USB 2.0 with M12 connector
- b. COM (RS-232) with M12 connector
- c. LAN 1 with M12 connector
- d. LAN 2 with M12 connector
- e. 24 V_{DC} input with M12 connector