

User Manual

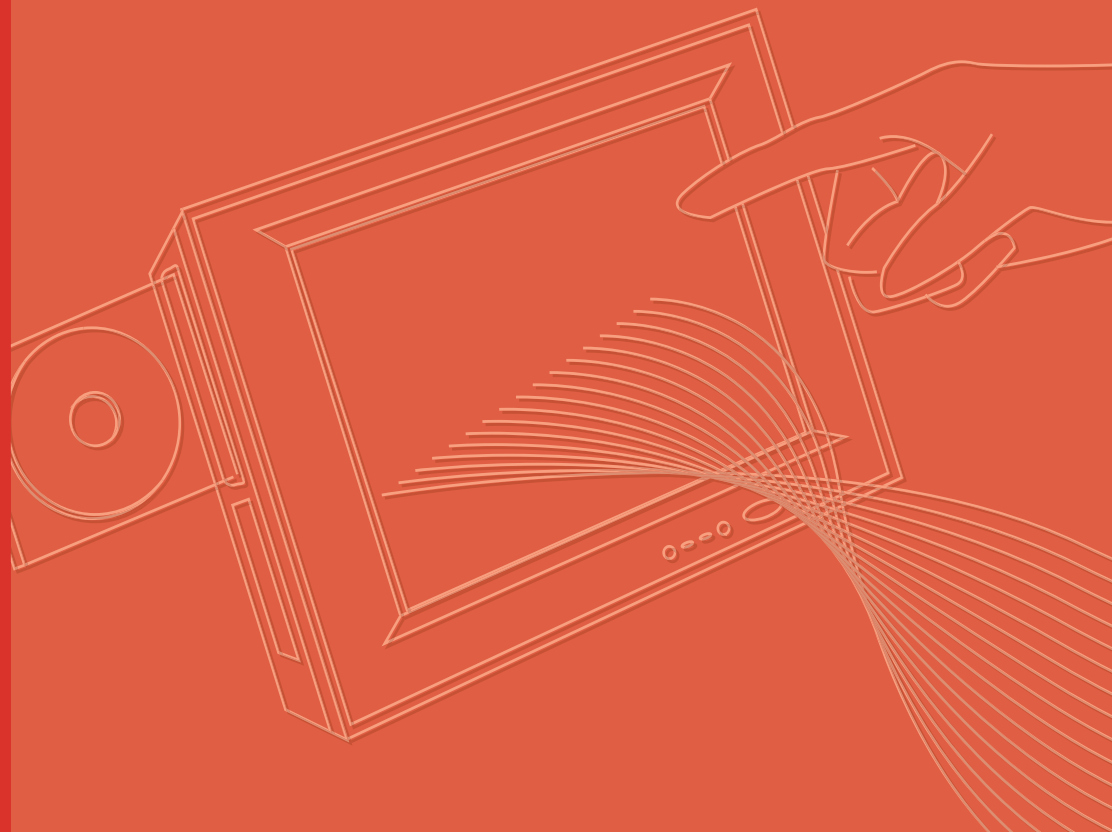

PPC-177T

**Intel® Core 2 Duo Processor-
Based Panel PC with 17" Color
TFT LCD Display**

Trusted ePlatform Services

ADVANTECH

Copyright

The documentation and the software included with this product are copyrighted 2009 by Advantech Co., Ltd. All rights are reserved. Advantech Co., Ltd. reserves the right to make improvements in the products described in this manual at any time without notice. No part of this manual may be reproduced, copied, translated or transmitted in any form or by any means without the prior written permission of Advantech Co., Ltd. Information provided in this manual is intended to be accurate and reliable. However, Advantech Co., Ltd. assumes no responsibility for its use, nor for any infringements of the rights of third parties, which may result from its use.

Acknowledgements

Intel and Pentium are trademarks of Intel Corporation.

Microsoft Windows and MS-DOS are registered trademarks of Microsoft Corp.

All other product names or trademarks are properties of their respective owners.

Product Warranty (2 years)

Advantech warrants to you, the original purchaser, that each of its products will be free from defects in materials and workmanship for two years from the date of purchase.

This warranty does not apply to any products which have been repaired or altered by persons other than repair personnel authorized by Advantech, or which have been subject to misuse, abuse, accident or improper installation. Advantech assumes no liability under the terms of this warranty as a consequence of such events.

Because of Advantech's high quality-control standards and rigorous testing, most of our customers never need to use our repair service. If an Advantech product is defective, it will be repaired or replaced at no charge during the warranty period. For out-of-warranty repairs, you will be billed according to the cost of replacement materials, service time and freight. Please consult your dealer for more details.

If you think you have a defective product, follow these steps:

1. Collect all the information about the problem encountered. (For example, CPU speed, Advantech products used, other hardware and software used, etc.) Note anything abnormal and list any onscreen messages you get when the problem occurs.
2. Call your dealer and describe the problem. Please have your manual, product, and any helpful information readily available.
3. If your product is diagnosed as defective, obtain an RMA (return merchandise authorization) number from your dealer. This allows us to process your return more quickly.
4. Carefully pack the defective product, a fully-completed Repair and Replacement Order Card and a photocopy proof of purchase date (such as your sales receipt) in a shippable container. A product returned without proof of the purchase date is not eligible for warranty service.
5. Write the RMA number visibly on the outside of the package and ship it prepaid to your dealer.

Declaration of Conformity

CE

This product has passed the CE test for environmental specifications when shielded cables are used for external wiring. We recommend the use of shielded cables. This kind of cable is available from Advantech. Please contact your local supplier for ordering information.

CE

This product has passed the CE test for environmental specifications. Test conditions for passing included the equipment being operated within an industrial enclosure. In order to protect the product from being damaged by ESD (Electrostatic Discharge) and EMI leakage, we strongly recommend the use of CE-compliant industrial enclosure products.

FCC Class B

Note: This equipment has been tested and found to comply with the limits for a Class B digital device, pursuant to part 15 of the FCC Rules. These limits are designed to provide reasonable protection against harmful interference when the equipment is operated in a commercial environment. This equipment generates, uses, and can radiate radio frequency energy and, if not installed and used in accordance with the instruction manual, may cause harmful interference to radio communications. Operation of this equipment in a residential area is likely to cause harmful interference in which case the user will be required to correct the interference at his own expense.

Technical Support and Assistance

1. Visit the Advantech web site at www.advantech.com/support where you can find the latest information about the product.
2. Contact your distributor, sales representative, or Advantech's customer service center for technical support if you need additional assistance. Please have the following information ready before you call:
 - Product name and serial number
 - Description of your peripheral attachments
 - Description of your software (operating system, version, application software, etc.)
 - A complete description of the problem
 - The exact wording of any error messages

Safety Instructions

1. Read these safety instructions carefully.
2. Keep this User Manual for later reference.
3. Disconnect this equipment from any AC outlet before cleaning. Use a damp cloth. Do not use liquid or spray detergents for cleaning.
4. For plug-in equipment, the power outlet socket must be located near the equipment and must be easily accessible.
5. Keep this equipment away from humidity.
6. Put this equipment on a reliable surface during installation. Dropping it or letting it fall may cause damage.
7. The openings on the enclosure are for air convection. Protect the equipment from overheating. **DO NOT COVER THE OPENINGS.**
8. Make sure the voltage of the power source is correct before connecting the equipment to the power outlet.
9. Position the power cord so that people cannot step on it. Do not place anything over the power cord.
10. All cautions and warnings on the equipment should be noted.
11. If the equipment is not used for a long time, disconnect it from the power source to avoid damage by transient overvoltage.
12. Never pour any liquid into an opening. This may cause fire or electrical shock.
13. Never open the equipment. For safety reasons, the equipment should be opened only by qualified service personnel.
14. If one of the following situations arises, get the equipment checked by service personnel:
 15. The power cord or plug is damaged.
 16. Liquid has penetrated into the equipment.
 17. The equipment has been exposed to moisture.
 18. The equipment does not work well, or you cannot get it to work according to the user's manual.
 19. The equipment has been dropped and damaged.
 20. The equipment has obvious signs of breakage.
21. **DO NOT LEAVE THIS EQUIPMENT IN AN ENVIRONMENT WHERE THE STORAGE TEMPERATURE MAY GO BELOW -20° C (-4° F) OR ABOVE 60° C (140° F). THIS COULD DAMAGE THE EQUIPMENT. THE EQUIPMENT SHOULD BE IN A CONTROLLED ENVIRONMENT.**
22. **CAUTION: DANGER OF EXPLOSION IF BATTERY IS INCORRECTLY REPLACED. REPLACE ONLY WITH THE SAME OR EQUIVALENT TYPE RECOMMENDED BY THE MANUFACTURER, DISCARD USED BATTERIES ACCORDING TO THE MANUFACTURER'S INSTRUCTIONS.**
23. The sound pressure level at the operator's position according to IEC 704-1:1982 is no more than 70 dB (A).

DISCLAIMER: This set of instructions is given according to IEC 704-1. Advantech disclaims all responsibility for the accuracy of any statements contained herein.

Safety Precaution - Static Electricity

Follow these simple precautions to protect yourself from harm and the products from damage.

- To avoid electrical shock, always disconnect the power from your PC chassis before you work on it. Don't touch any components on the CPU card or other cards while the PC is on.
- Disconnect power before making any configuration changes. The sudden rush of power as you connect a jumper or install a card may damage sensitive electronic components.

Contents

Chapter 1	General Information	1
1.1	Introduction	2
1.2	Specifications	2
1.2.1	General Specifications	2
1.2.2	Standard PC Functions	2
1.2.3	Internal Graphics Specification	2
1.2.4	Audio Function	2
1.2.5	Ethernet Interface	3
1.2.6	Touchscreen Specifications (Optional)	3
	Table 1.1: Touchscreen Specifications	3
1.2.7	Optional Module	3
1.2.8	Environment	3
1.2.9	Certifications:	3
1.3	Dimensions	4
	Figure 1.1 Dimensions of PPC-177T	4
Chapter 2	System Setup	5
2.1	A Quick Tour of the Panel PC	6
	Figure 2.1 Front Panel of PPC-177T	6
	Figure 2.2 Side View of the Panel PC	6
	Figure 2.3 I/O Peripheral Connectors Panel	7
	Figure 2.4 Rear View of the Panel PC	7
2.2	Preparing for First-time Use	8
2.3	Installation Procedures	8
2.3.1	Connecting the power cord	8
2.3.2	Connecting the keyboard and mouse	8
2.3.3	Switching on the power	8
2.4	Running the BIOS Setup Program	8
2.5	Installing System Software	9
2.6	Installing the Drivers	9
	Figure 2.5 Drivers and Utilities on the CD-ROM	9
Chapter 3	Using the Panel PC	11
3.1	Introduction	12
3.2	CD-ROM Drive (Optional)	12
	Figure 3.1 Inserting and ejecting a CD-ROM	12
3.3	PS/2 Mouse and Keyboard	12
3.4	PCI or PCI-E Bus Expansion	13
	Figure 3.2 PCI & PCI-E Bus Expansion	13
3.5	Serial COM Ports	14
	Figure 3.3 I/O Ports	14
3.6	VGA Port	14
3.7	USB Ports	15
3.8	Audio Interface	15
3.9	Ethernet	15
3.10	Touchscreen (Optional)	15
Chapter 4	Hardware Installation	17
4.1	Jumpers and Connectors	18

4.2	Disassembling the Panel PC	18
	Figure 4.1 Unfastening the Rear Cover	18
	Figure 4.2 Disconnecting the Fan Connector	19
	Figure 4.3 The PPC without the Rear Cover	19
4.3	Installing the 2.5" Hard Disk Drive	20
	Figure 4.4 The PPC Side Cover	20
	Figure 4.5 The PPC HDD	20
	Figure 4.6 Plugging in the SATA Cable	21
4.4	Installing the Central Processing Unit (CPU)	21
	Figure 4.7 Placing the CPU in the Socket	22
	Figure 4.8 Tightening the Screws on the CPU	22
	Figure 4.9 Placing the Heatsink and Fan on the CPU and then Fastening.....	23
4.5	Installing the DDR2 SDRAM Memory Module	23
	Figure 4.10 Placing the Memory Module in the SODIMM Socket	23
4.6	Installing the Optical Device Drive	24
	Figure 4.11 Rear Cover Photo.....	24
	Figure 4.12 Rear Cover Photo with ODD Bracket	24
	Figure 4.13 IO shielding	25
	Figure 4.14 SATA CD-ROM cable.....	25

Chapter 5 Jumpers and Connectors..... 27

5.1	Jumpers and Connectors.....	28
5.1.1	Setting Jumpers.....	28
5.1.2	Jumpers.....	29
5.1.3	Jumper and Connector Locations.....	30
	Figure 5.1 Jumpers & Connectors on PPC-177T Motherboard.	30
5.1.4	Connectors	30
	Table 5.1: CN1 (USB Port 7/8).....	31
	Table 5.2: CN2 (CPU FAN Connector)	32
	Table 5.3: CN3 (LVDS2 Connector).....	32
	Table 5.4: CN4 (LVDS1 Connector).....	33
	Table 5.5: CN5 (System FAN Connector)	33
	Table 5.6: CN8 (SATA HDD Power Connector).....	33
	Table 5.7: CN9 (SATA HDD Connector)	33
	Table 5.8: CN10 (+V12 Power Connector)	34
	Table 5.9: CN12 (ATX Power Input Connector)	34
	Table 5.10: CN13 (USB Port 5/6).....	34
	Table 5.11: CN15 (SPI Reflash Connector)	34
	Table 5.12: CN17 (SATA ODD Connector).....	35
	Table 5.13: CN18 (SATA ODD Power Connector).....	35
	Table 5.14: CN19 (Multi Function PCI Express by1 Connector) .	35
	Table 5.15: CN21 (Printer Port Connector)	36
	Table 5.16: CN22 (LCD Light Sense Connector)	36
	Table 5.17: CN24 (COM4 Connector).....	36
	Table 5.18: CN25 (Front Panel LED Connector).....	36
	Table 5.19: CN26 (COM1 RI Function Selection Connector).....	37
	Table 5.20: CN28 (LCD Back Light Connector)	37
	Table 5.21: CN29 (Power Button Connector).....	37
	Table 5.22: CN35 (Internal Speaker Connector).....	37
	Table 5.23: CN37 (MINIDIN PS2 Connector).....	37
	Table 5.24: CN41 (Clear CMOS Connector (Reserved))	38
	Table 5.25: CN42 (COM2 RI Function Selection Connector).....	38
	Table 5.26: CN43 (COM3 RI Function Selection Connector).....	38
	Table 5.27: CN44 (COM4 RI Function Selection Connector).....	38
	Table 5.28: CN45 (AT Power Solution Connector)	38
5.1.5	Jumper Settings.....	39
	Table 5.29: CN26 (COM1 RI Function Selection Connector).....	39

Table 5.30: CN42 (COM3 RI Function Selection Connector)	39
Table 5.31: CN43 (COM4 RI Function Selection Connector)	39
Table 5.32: CN44 (COM2 RI Function Selection Connector)	39
Table 5.33: CN45 (AT Power Selection)	39

Chapter 6 Driver Installation41

6.1 Introduction	42
6.1.1 Driver Installation	42
6.2 Updating Driver Search on the Advantech Website	42

Appendix A PCI Card and PCI-E Size Limits.....43

A.1 PCI Interface Card	44
A.2 PCI-E Interface Card	44

Chapter 1

General Information

This chapter gives background information on the PPC-177T.

Sections include:

- Specifications
- Dimensions

1.1 Introduction

Advantech PPC-177T is an Intel Core 2 Duo processor based Panel PC with a bright 17" LCD display. The powerful Core 2 Duo CPU and Intel 945GME chipsets bring the most dynamic applications to life without sacrifices to any industrial reliability. The Internal CF card interface can serve as an alternative HDD solution for OS booting and the Mini PCI interface can be used by many expansion cards such as a wireless LAN card to extend device mobility. In order to satisfy customers security concerns, PPC-177T is also offered in a two Gigabit LAN port configuration. Four serial ports and four USB V2.0 ports give the PPC-177 advanced versatile applications.

1.2 Specifications

1.2.1 General Specifications

- **Dimensions (W X H X D):** 442 x 362 x 111.5 mm (17.40" x 14.25" x 4.39")
- **Weight:** 7.5 kg (16.52 lb)
- **Power:**
 - -AC Model: 150 W (max.)
 - -Input voltage: 100-240 Vac, 50-60 Hz, 2-4 A
 - -Output Voltage: +3.3 V @ 4.5 A, +5 V @ 8.5 A, +12 V @ 7.0 A, +5 Vsb @ 1.5 A, -12 V @ 0.3 A
 - -DC Model: 100 W (max.)
 - -Input voltage: 16-32 Vdc
 - -Output voltage: +3.3 V @ 5 A, +5 Vdc @ 8 A, +12 Vdc @ 5 A, +5 Vsb @ 1 A, -12 V @ 0.1 A

1.2.2 Standard PC Functions

- **CPU:** Supports Intel® Core® 2 Duo processor up to 2.16 GHz
- **BIOS:** Award 4 MB Flash BIOS, supports plug and play, ACPI (advanced configuration and power interface)
- **Chipset:** Intel 945GME / ICH7M
- **RAM:** Two 200-pin sockets up to 4 GB DDR2 SDRAM
- **Serial ports:** Four serial ports, COM1, 3 and 4 are RS-232, COM2 is RS-232/422/485
- **Universal serial bus (USB) port:** Supports up to four USB V2.0 ports
- **Bus Expansion:** One PCI-e expansion slot
- **Battery:** 3.0 V @ 195 mA lithium battery

1.2.3 Internal Graphics Specification

- Intel Gen. 3.5 integrated graphics Engine
- 250 MHz core render clock and 200 MHz core display at 1.05 V core voltage
- Dynamic video memory technology 2.0 (Intel DPST 2.0)
- Intel smart 2D display Technology (Intel S2DDT)
- Microsoft DirectX* 9.1

1.2.4 Audio Function

- **Chipset:** Realtek ALC888
- **Audio controller:** Supports host/soft audio from the Intel ICH series chipset and also from any other HDA compatible audio controller

- **Stereo sound:** Two stereo ADCs support 16/20/24-bit PCM format, one for stereo microphone, one for legacy mixer recording

1.2.5 Ethernet Interface

- Compliant to 802.3x flow control support
- IEEE 802.1p and 802.1q support
- 10/100/1000 IEEE 802.3 compliant
- Automatic MDI/MDIX crossover at all speeds

1.2.6 Touchscreen Specifications (Optional)

Table 1.1: Touchscreen Specifications

Type	Analog Resistive	Capacitive	Surface Acoustic Wave (SAW)
Resolution	Continuous	1024 x 1024	4096 x 4096
Light Transmission	75%	85%	91%
Controller	RS-232 Interface (COM4)		
Power Consumption	+5 V @ 200 mA	+5 V @ 100 mA	+5 V @ 150 mA
Software Driver	Supports both DOS and Windows		
Durability (touches in a life- time)	35 million	225 million	50 million

1.2.7 Optional Module

- **CPU:** Supports Intel® Core® 2 Duo processor up to 2.16 GHz
- **Memory:** Supports up to 4 GB DDR2 SDRAM [200pin SODIMM socket x 2]
- **HDD:** Supports 2.5" SATA HDD
- **Touchscreen:** Analog resistive, capacitive, or Surface acoustic Wave
- **DVD+/-RW Drive:** SATA Slim 8X or above
- **Combo Drive:** SATA Slim DVD/CD-RW 8D/24W/24E/24R or above
- **CF:** One type II CF slot
- **PCMCIA interface:** Complies wit 1995 PCMCIA card standard

1.2.8 Environment

- **Temperature:** 0~50° C (32~122° F)
- **Relative humidity:** 10~95% @ 40° C (non-condensing)
- **Shock:** 10 G peak acceleration (11 msec duration)

1.2.9 Certifications:

- **EMC:** CE, FCC, BSMI, CCC
- **BSMI approved Safety:** CE, UL, CB

1.3 Dimensions

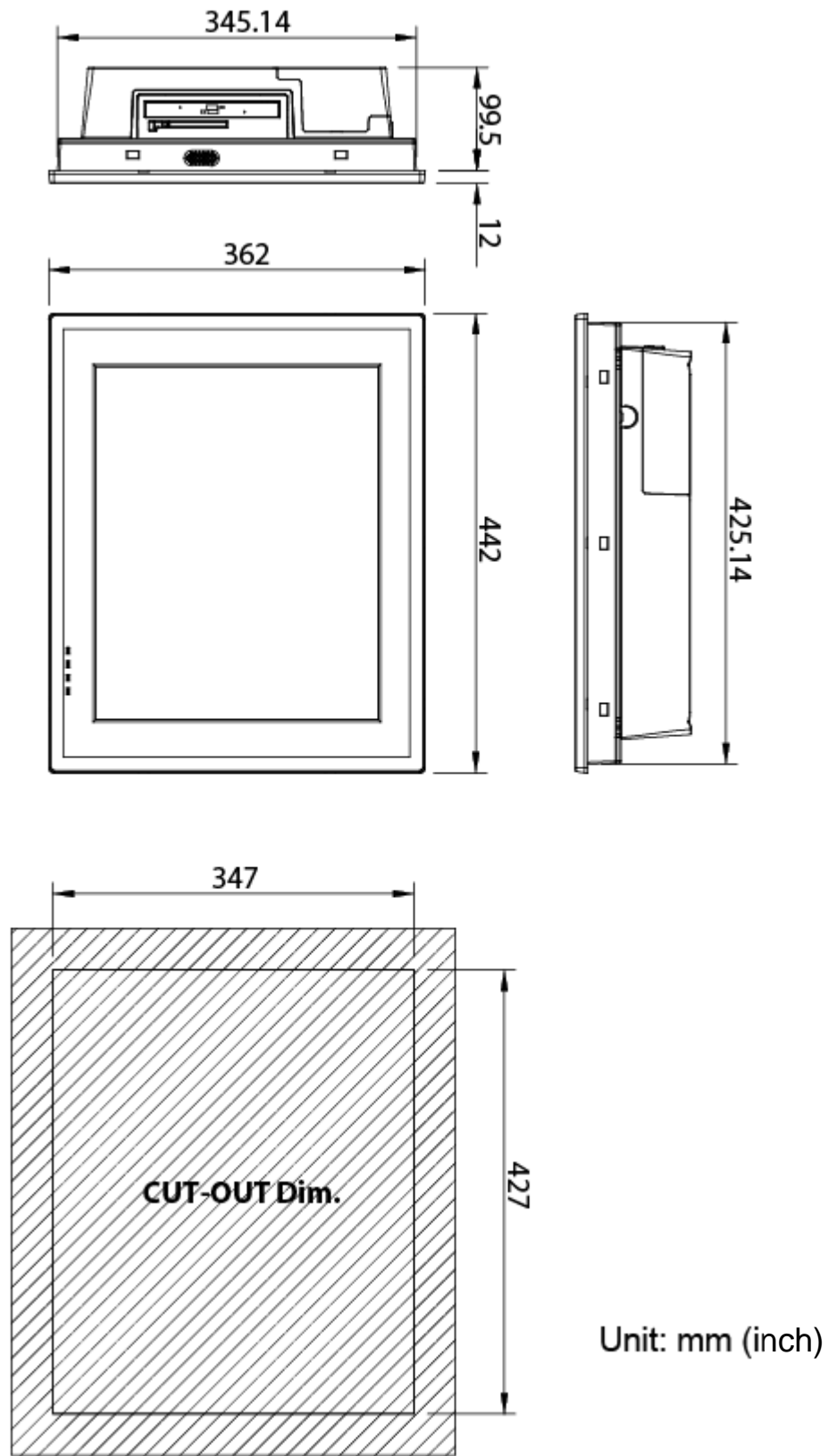

Figure 1.1 Dimensions of PPC-177T

Chapter 2

System Setup

This chapter gives system setup information for the PPC-177T.

Sections include:

- A Quick Tour
- Installation Procedures
- Running the BIOS Setup
- Installing System software

2.1 A Quick Tour of the Panel PC

Before starting to set up the panel PC, take a moment to become familiar with the locations and purposes of controls, drives, connectors and ports, which are illustrated in the figures below.

When placed upright on the desktop, the front panel of the panel PC appears as shown in Figure 2.1.

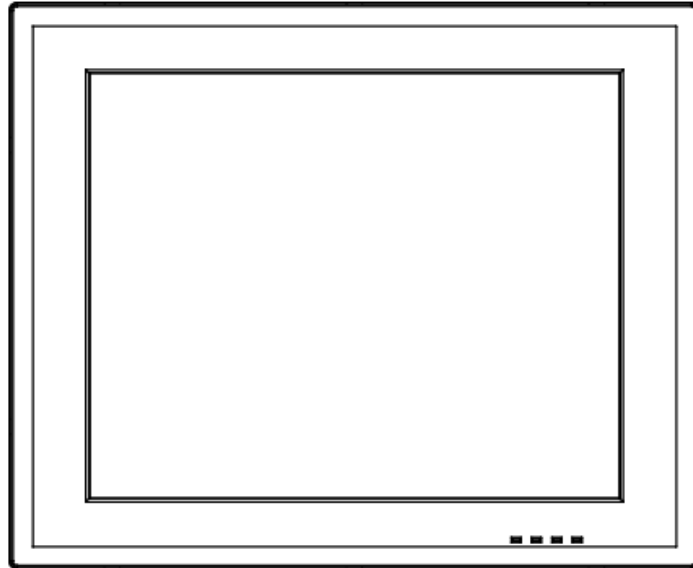

Figure 2.1 Front Panel of PPC-177T

When viewed from the left side of the panel PC, the optical device drive, USB ports and PCMCIA expansion sockets are visible, as shown in Figure 2.2.

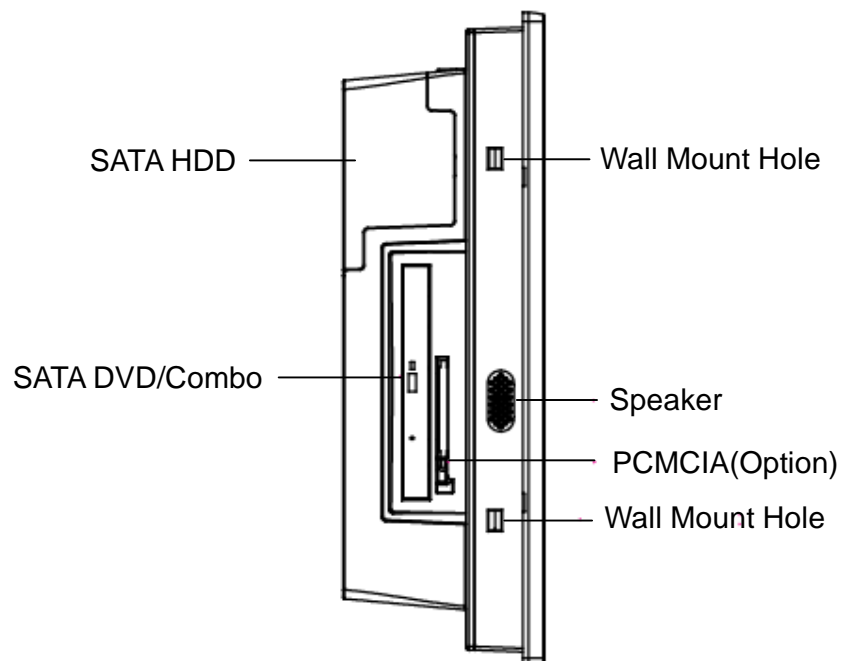
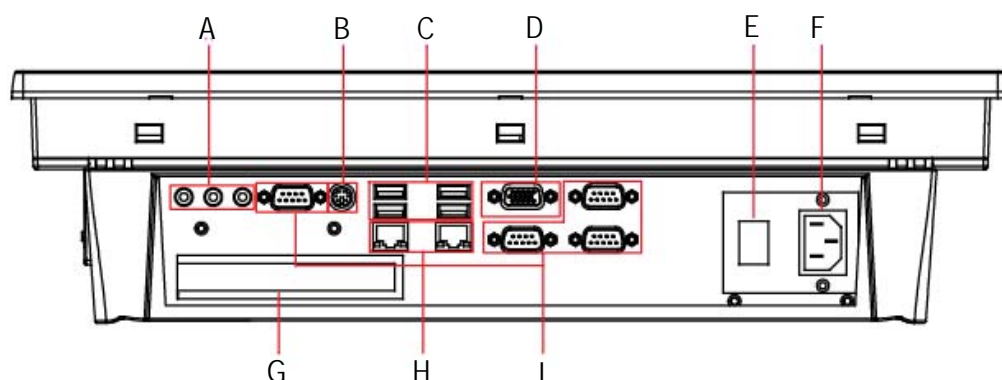

Figure 2.2 Side View of the Panel PC

Viewed from the bottom. Please note that the expansion slot is optional for either one PCI slot or one PCI Express. It is located on the back of the Panel PC as shown in Figure 2.3. (The I/O section includes various I/O ports, including serial ports, USB ports, the Ethernet ports, KB/MS, the audio jacks, and so on.)



- | | |
|----------------------------|---------------------------------|
| A: Line in/Line out/Mic in | F: AC Inlet |
| B: PS2 Mouse&Keyboard | G: PCI-e Slot x 1 |
| C: USB 2.0 x 4 | H: 10/100/1000 Base-T Ether |
| D: VGA Port | I: RS232 x 3, RS232/422/485 x 1 |
| E: Power Switch | |

Figure 2.3 I/O Peripheral Connectors Panel

VESA standard both 100 x 100 mm and 75 x 75 mm mounting size.

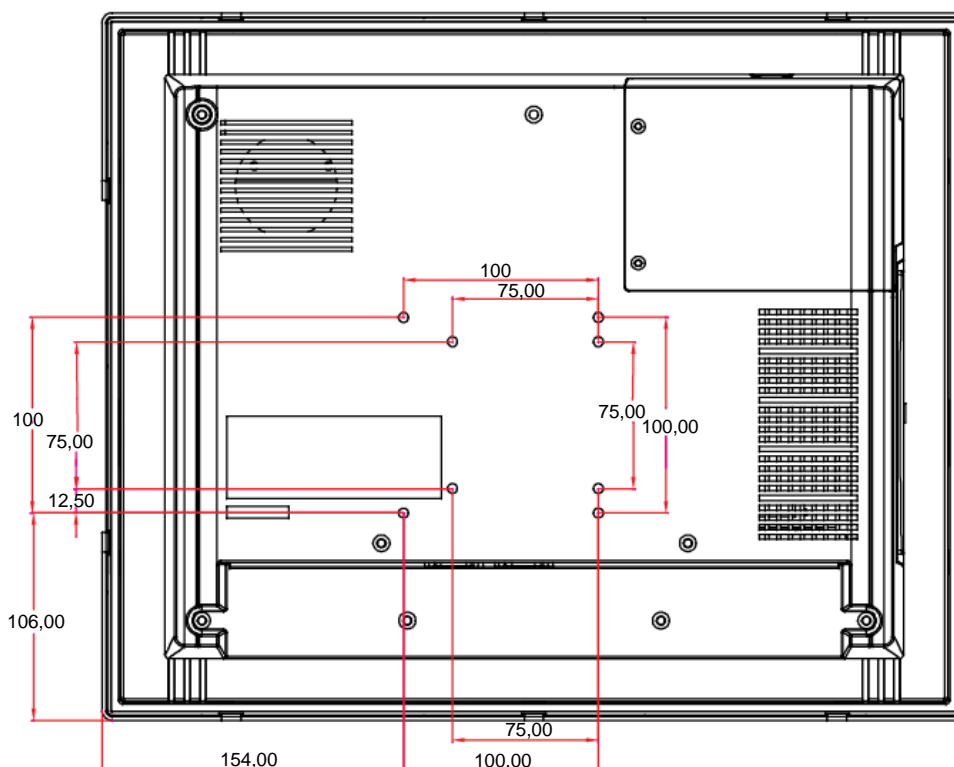

Figure 2.4 Rear View of the Panel PC

2.2 Preparing for First-time Use

Before commencing set up of the panel PC system, the following items should be available:

- Keyboard
- Mouse (for system software installation)

2.3 Installation Procedures

2.3.1 Connecting the power cord

The panel PC can only be powered through an AC electrical outlet (100 ~ 250 volts, 50 ~ 60 Hz). Be sure to handle the power cords by holding the plug ends only. Follow these procedures in order:

1. Connect the female end of the power cord to the AC inlet of the panel PC.
2. Connect the 3-pin male plug of the power cord to an electrical outlet.

Note! DC model is 100 W (max.), input voltage: 16-32 VDC.



2.3.2 Connecting the keyboard and mouse

Connect the PS/2 mouse and keyboard to the I/O section of PPC.

If using a serial mouse and the panel PC has a touchscreen, it is possible to connect the mouse to any COM port.

2.3.3 Switching on the power

Switch on the power switch, which is located inside the bottom side cover.

2.4 Running the BIOS Setup Program

The panel PC will be properly set up and configured by the dealer prior to delivery. However, it may be necessary to use the panel PC's BIOS (Basic Input-Output System) setup program to change the system configuration information, such as the current date and time, or the type of hard drive. The setup program is stored in read-only memory (ROM). It can be accessed either when you turn on or reset the panel PC, by pressing the 'Del' key on your keyboard immediately after powering on the computer. The settings specified with the setup program are recorded in a special area of memory called "CMOS RAM". This memory is backed up by a battery so that it will not be erased after turning off or resetting the system. Whenever the power is turned on, the system reads the settings stored in CMOS RAM and compares them to the equipment check conducted during the power on self-test (POST). If a problem occurs, an error message will be displayed on screen, and the computer prompts the user to run the setup program.

2.5 Installing System Software

Recent releases of operating systems from major vendors include setup programs which load automatically and guide you through hard disk formatting and operating system installation. The guidelines below will help determine the steps necessary to install the operating system onto the panel PC hard drive.

Note! *Some distributors and system integrators may have already pre installed system software prior to shipment.*



2.6 Installing the Drivers

After installing your system software, you will be able to set up the Chipset, Ethernet, VGA, audio, PCMCIA, and touchscreen functions. All the drivers are stored in a CD-ROM disc entitled "Drivers and Utilities". The CD-ROM can be found in your accessory box.



Figure 2.5 Drivers and Utilities on the CD-ROM

The various drivers and utilities in the CD-ROM disc which help users install the drivers and understand their functions. These files are a very useful supplement to the information in this manual.

Note! *The drivers and utilities used for the PPC-177 panel PCs are subject to change without notice. If in doubt, check Advantech's website or contact our application engineers for the latest information regarding drivers utilities.*



Chapter 3

Using the Panel PC

This chapter explains onboard devices and peripheral I/O ports available on the PPC-177T.

Sections include:

- CD-ROM Drive
- PS/2 Mouse and Keyboard
- PCI or PCI-E Bus Expansion
- Serial COM Ports
- VGA Port
- USB Ports
- Audio Interface
- Ethernet
- Touchscreen (Optional)

3.1 Introduction

This chapter describes basic features and procedures for using the panel PC. Topics covered include: the CD-ROM drive, I/O ports and the touchscreen.

3.2 CD-ROM Drive (Optional)

It is possible to use the USB external optical device.

To insert a CD-ROM disc, press the eject button on the CD-ROM drive.

To eject a CD-ROM disc, first ensure that the drive activity light is not active. Then press the eject button on the drive.



Figure 3.1 Inserting and ejecting a CD-ROM

3.3 PS/2 Mouse and Keyboard

1. To install a full-size desktop PS/2 keyboard and mouse with the panel PC, follow these instructions:
2. Be sure the panel PC is turned off.
3. Attach the keyboard to the purple colored 5-pin PS/2 port.
4. Attach the PS/2 mouse to the green colored port.
5. Turn on the panel PC.

3.4 PCI or PCI-E Bus Expansion

The panel PC supports either one PCI or one PCI-E bus expansion card. To integrate a new expansion bus card into the system, follow these instructions:

1. Turn off the panel PC.
2. Unscrew the screws on the top of the rear cover, and remove them.
3. Remove the metal plate by unscrewing the attaching screw.
4. Insert the PCI or PCI-e into the PCI-e slot of the riser card. (See Figure 3.2)
5. Run the setup program within the OS to configure the system.

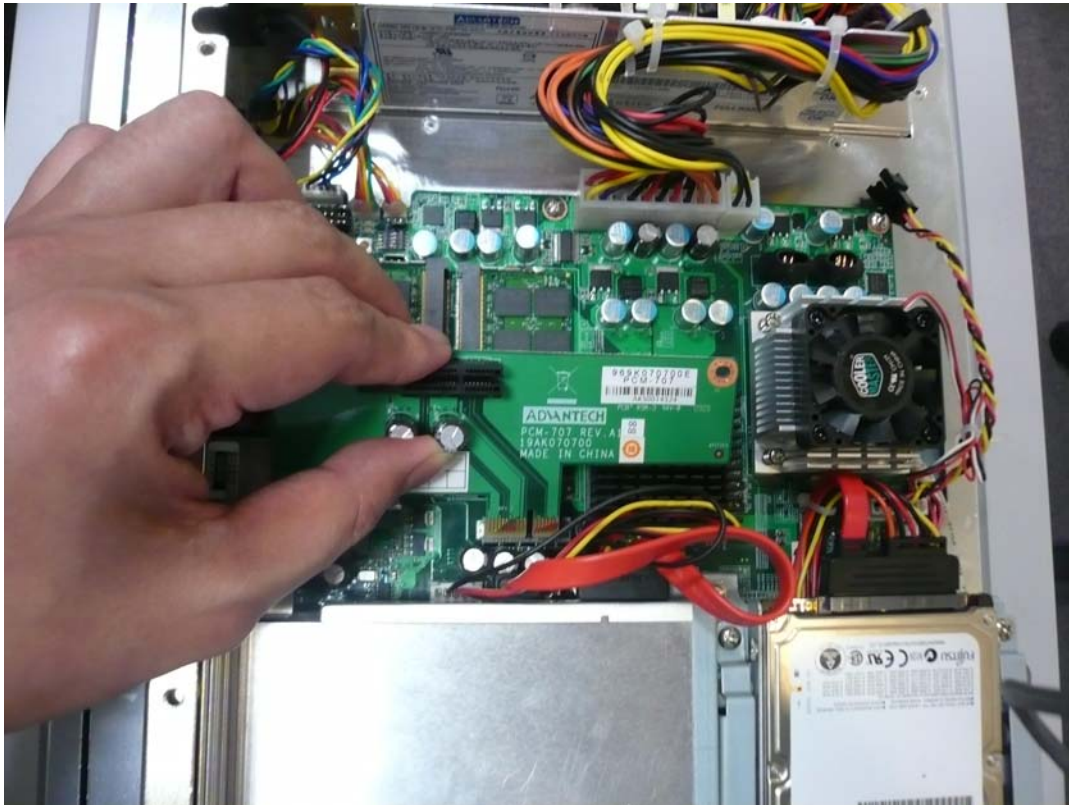
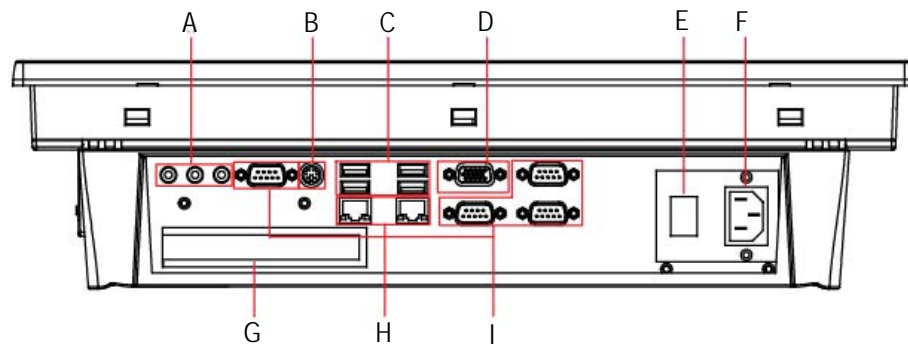

Figure 3.2 PCI & PCI-E Bus Expansion

3.5 Serial COM Ports

There are four serial COM ports on the bottom. It is simple to attach a serial device to the panel PC, like an external modem or mouse. Follow these instructions:

1. Be sure the panel PC and any other peripheral devices that are connected to the panel PC are turned off.
2. Attach the interface cable of the serial device to the panel PC's serial port. (See Figure 3.3.) If necessary, attach the other end of the interface cable to the serial device. Fasten any retaining screws.
3. Turn on any other peripheral devices which are connected to the panel PC, and then turn on the panel PC.
4. Refer to the manual(s) which accompanied any serial device(s) for instructions on configuring the operating environment to recognize the device(s).
5. Run the BIOS setup program and configure the jumper settings to change the mode of the COM ports.



A: Line in/Line out/Mic in	F: AC Inlet
B: PS2 Mouse&Keyboard	G: PCI-e Slot x 1
C: USB 2.0 x 4	H: 10/100/1000 Base-T Ether
D: VGA Port	I: RS232 x 3, RS232/422/485 x 1
E: Power Switch	

Figure 3.3 I/O Ports

3.6 VGA Port

An external VGA-compatible device may be connected to the system through the 15-pin external port located on the bottom of the system unit.

The panel PC simultaneously supports an external CRT monitor in addition to the built-in LCD display.

1. Be sure the panel PC is turned off.
2. Connect the external monitor to the system. (See Figure 3.3.)
3. Turn on the panel PC and the external monitor.

3.7 USB Ports

An external USB device may be connected to the system through the 4-pin USB ports located on the rear side and left side of the system unit.

1. Connect the external device to the system. (See Figure 3.3)
2. The USB ports support hot plug-in connections. Install the device driver before using the device.

3.8 Audio Interface

The audio interface includes three jacks: Microphone in, Line out and Line in. (See Figure 3.3) Their functions are:

- Microphone in: Use an external microphone to record voice and sound.
 - Line out: Output audio to external devices such as speakers or earphones.
 - Line in: Input audio from an external CD player or radio.
1. Connect the audio device to the system. (See Figure 3.3)
 2. Install the driver before using the device.

3.9 Ethernet

External devices on the network may be connected to the system through the external Ethernet port located on the bottom of the system unit.

1. Be sure the panel PC is turned off.
2. Connect the external device(s) to the panel PC.
3. Turn on the panel PC and the external device(s).

3.10 Touchscreen (Optional)

The touchscreen is connected to the internal USB port. Its function is similar to that of a mouse. There are 3 kinds of touchscreens that support the PPC-177T: Resistive, capacitive and SAW type.

It is necessary to install the touchscreen driver before it will function. The touchscreen drivers for various operating systems are stored on the CD-ROM disc inside the accessory box.

Chapter 4

Hardware Installation

This chapter gives instructions for installing hardware devices on the PPC-177T.

Sections include:

- Jumpers and Connectors
- Disassembling the Panel PC
- Installing the Central
- Processing Unit (CPU)
- Installing the DDR SDRAM Memory Module

4.1 Jumpers and Connectors

The panel PC consists of a PC-based computer that is housed in a metal shielding case with a plastic cover on the rear and bottom. All the computer devices, like the CPU, HDD, SDRAM, and power supply are all readily accessible after removing the rear panel or the HDD cover. Any maintenance or hardware upgrades can be easily completed after removing the rear panel and/or HDD cover.

For information about complete disassembly of the panel PC, refer to Appendix B.

Warning! Do not remove the plastic rear cover until verifying that no power is flowing within the panel PC. Power must be switched off and the power cord must be unplugged. Each time the panel PC is serviced, users should be aware of this condition.



4.2 Disassembling the Panel PC

The following are standard procedures for disassembling the panel PC before upgrading the system. All procedures are illustrated in Figure 4.1, 4.2, 4.3.

1. Unfasten the screws securing the rear plastic cover and remove it.



Figure 4.1 Unfastening the Rear Cover

2. Before removing the rear cover, disconnect the system fan connector.



Figure 4.2 Disconnecting the Fan Connector



Figure 4.3 The PPC without the Rear Cover

4.3 Installing the 2.5" Hard Disk Drive

One enhanced Serial ATA (SATA) hard disk drive may be attached to the panel PC. The following instructions are for installing the HDD:

1. Remove the two screws on side cover first. (See Figure 4.4)

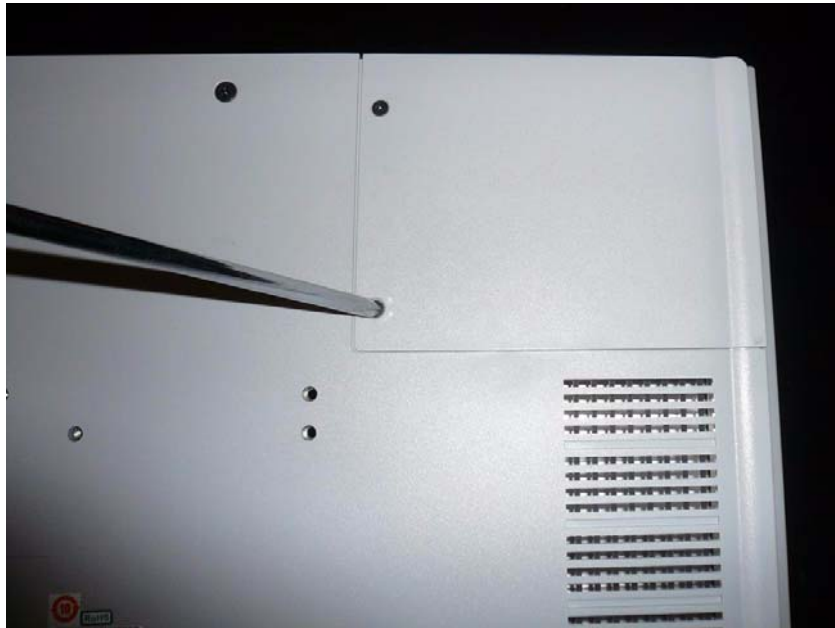

Figure 4.4 The PPC Side Cover

2. Remove the four screws on the metal plate of two side of HDD. (See Figure 4.6)



Figure 4.5 The PPC HDD

3. Connect SATA cable from main board.



Figure 4.6 Plugging in the SATA Cable

4.4 Installing the Central Processing Unit (CPU)

The panel PC is equipped with a central processing unit (CPU) that can be upgraded to improve system performance. The panel PC provides one 478-pin ZIF (Zero Insertion Force) socket, or “Socket 478”. The CPU must be fitted with an appropriate heat-sink and CPU fan to prevent overheating.

Warning! *The CPU may be damaged if operated without a heat sink, and if the fan is not connected to the CPU fan power connector.*



Caution! *Always disconnect the power cord from your panel PC when you are working on it. Do not make connections while the power is on as sensitive electronic components can be damaged by the sudden rush of power. Only experienced electronics personnel should open the panel PC.*



Follow these instructions to install a CPU:

1. Place the CPU carefully into the socket, taking care to align it properly.

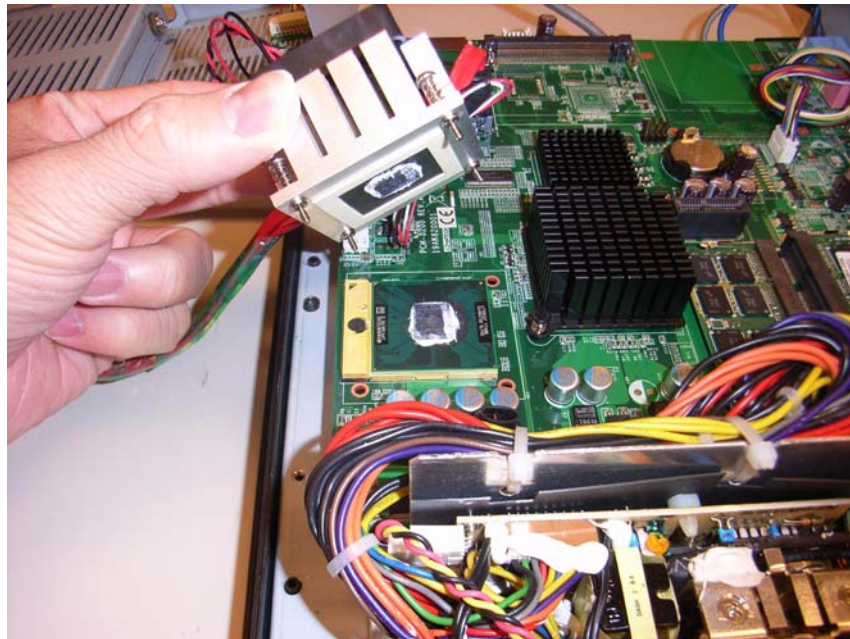

Figure 4.7 Placing the CPU in the Socket

2. Fasten the screw on the CPU socket mounting plate.

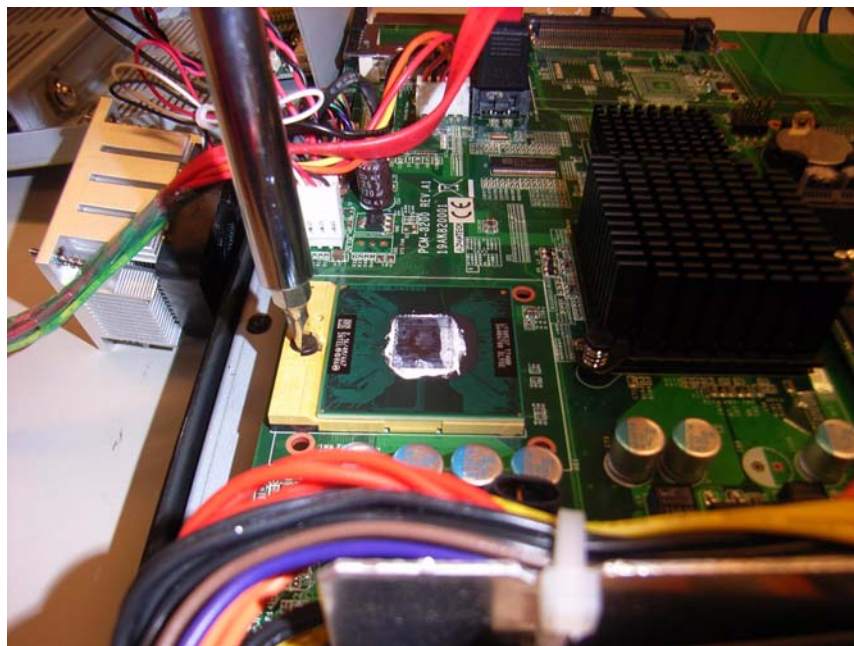

Figure 4.8 Tightening the Screws on the CPU

3. Place the heatsink and fan on top of the CPU, and fasten them with the retention bracket.

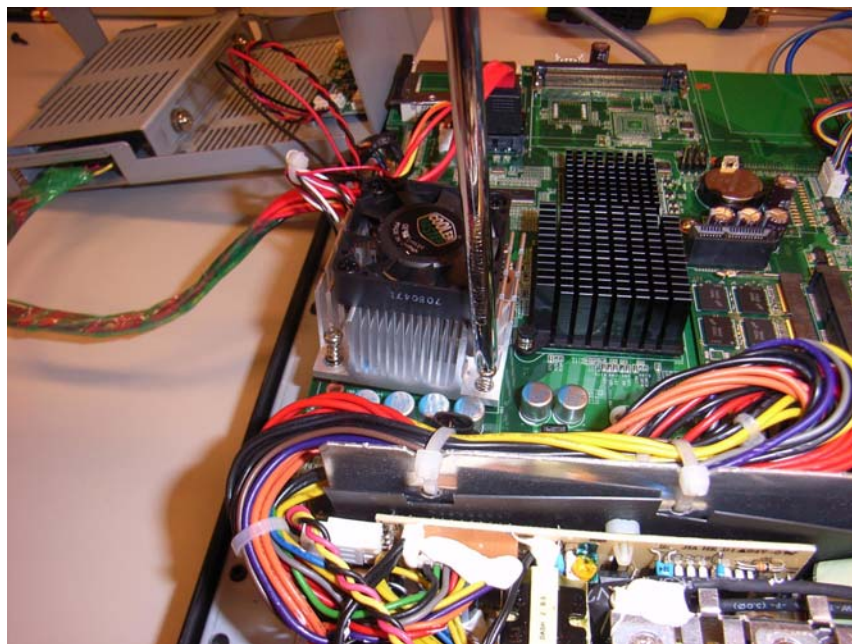

Figure 4.9 Placing the Heatsink and Fan on the CPU and then Fastening

4.5 Installing the DDR2 SDRAM Memory Module

The panel PC system provides two 200-pin SODIMM sockets and it is possible to install from 512 MB to 4 GB of DDR2 SDRAM memory.

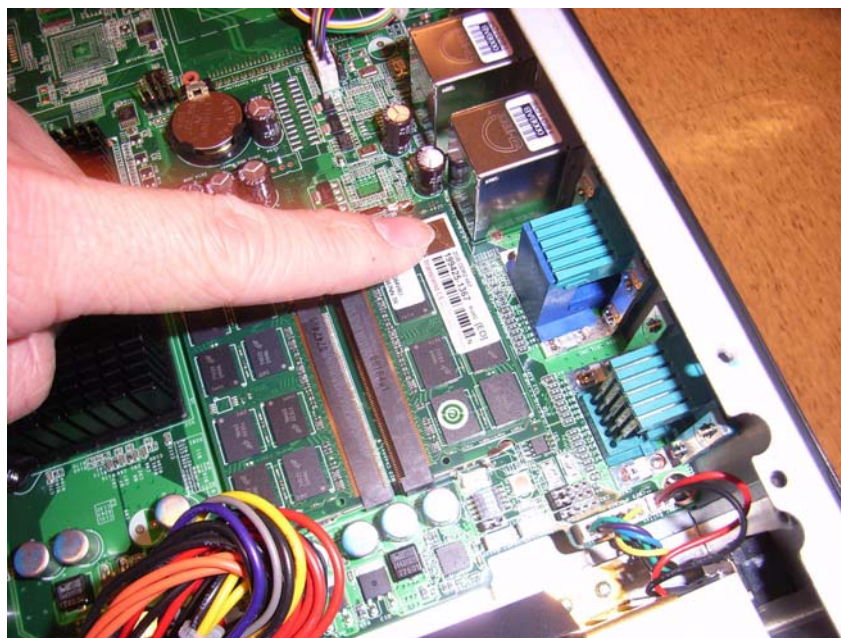

Figure 4.10 Placing the Memory Module in the SODIMM Socket

4.6 Installing the Optical Device Drive

1. Remove all the screws on the rear cover.



Figure 4.11 Rear Cover Photo

2. To loosen the screws on the CD-ROM module.

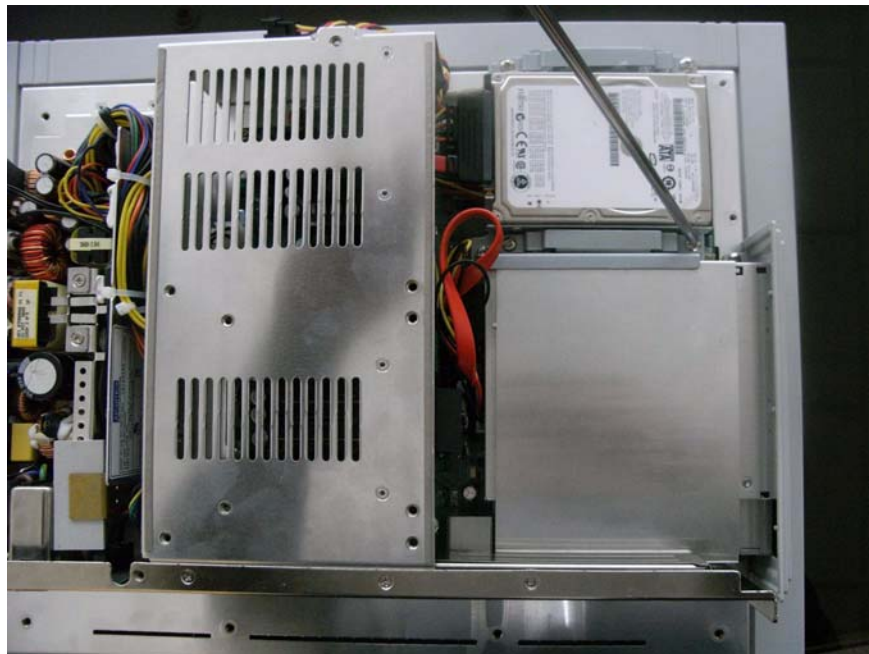

Figure 4.12 Rear Cover Photo with ODD Bracket

3. To loosen the screws on the IO shielding.



Figure 4.13 IO shielding

4. To remove the SATA cable from CD-ROM.



Figure 4.14 SATA CD-ROM cable

Chapter 5

Jumpers and Connectors

This chapter gives information on setting jumpers and using the connectors on the PPC-177T motherboard.

Sections include:

- Setting Jumpers
- Jumpers and Connectors locations
- Connectors

5.1 Jumpers and Connectors

This chapter supplies more detailed information about the internal jumper settings and an outline of the I/O ports available on the PPC-177T.

5.1.1 Setting Jumpers

The Panel PC can be configured to match the needs of each application by setting the jumpers. A jumper is the simplest kind of electrical switch. It consists of two metal pins and a small metal clip (often protected by a plastic cover), which slides over the pins to close the circuit and connect them. To "close" a jumper, connect the pins with the clip. To "open" a jumper, remove the clip. Sometimes a jumper has three pins, labeled 1, 2, and 3. In this case, it is possible to connect either pins 1 and 2 or pins 2 and 3 to each other.

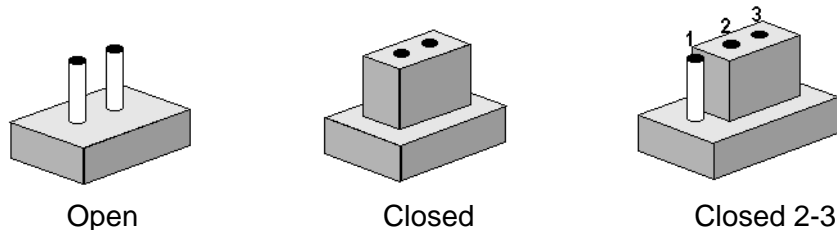

The jumper settings are schematically depicted in this manual as follows:

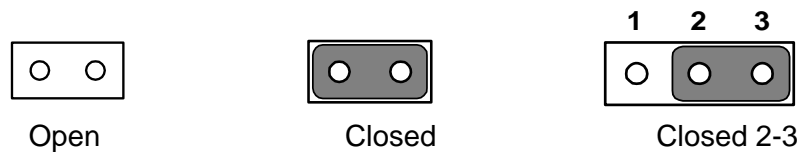

A pair of needle-nose pliers may be helpful when working with jumpers. If there are any doubts about the best hardware configuration for a particular application, contact the local distributor or sales representative before making any changes.

An arrow is printed on the motherboard to indicate the first pin of each jumper.

5.1.2 Jumpers

The motherboard of the Vehicle Mounted Computer has a number of jumpers that help configure the system. It also has LED indicator lamps that display the system operation status. The table below lists the function of each jumper and LED.

The motherboard of the PPC-177T has a number of jumpers that allow you to configure your system to suit your applications.

CN45: Power Type Selection

Default ATX Power input

ATX Power input (1-2) AT Power input (2-3)



CN26: COM1 PIN9 Function Selection

Default Ring function

Ring function (1-2)

Output 5 V(3-4)

Output 12 V(4-5)

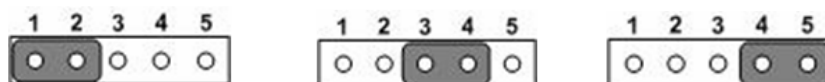

CN44: COM2 PIN9 Function Selection

Default Ring function

Ring function (1-2)

Output 5 V(3-4)

Output 12 V(4-5)

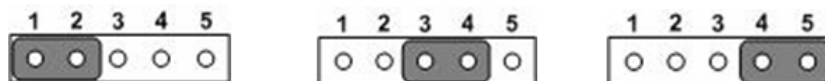

CN42: COM3 PIN9 Function Selection

Default Ring function

Ring function (1-2)

Output 5 V(3-4)

Output 12 V(4-5)

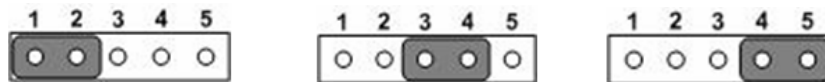

CN43: COM4 PIN9 Function Selection

Default Ring function

Ring function (1-2)

Output 5 V(3-4)

Output 12 V(4-5)

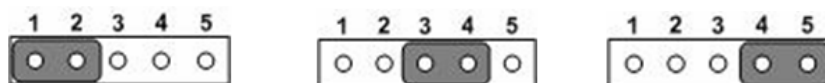

5.1.3 Jumper and Connector Locations

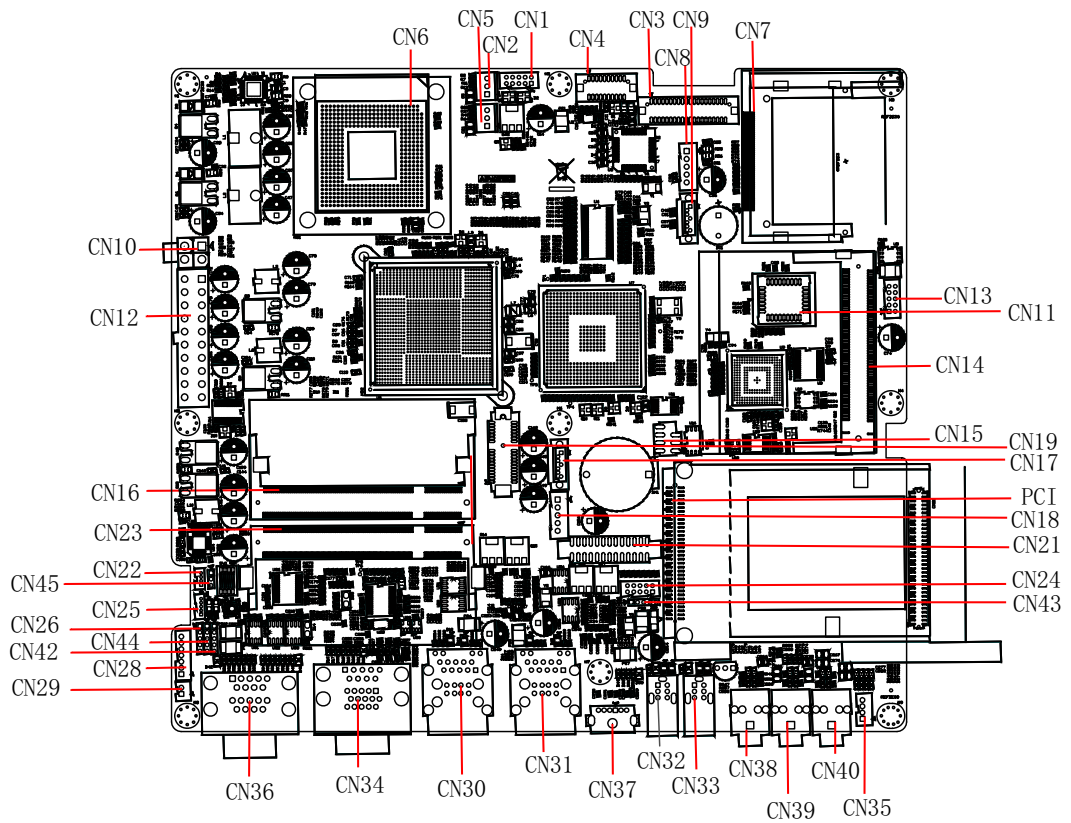

Figure 5.1 Jumpers & Connectors on PPC-177T Motherboard

5.1.4 Connectors

Onboard connectors link the panel PC to external devices such as hard disk drives. The table below lists the function of each of connectors.

CN1	USB port 7/8 connector
CN2	CPU FAN connector
CN3	LVDS2 connector (Reserved)
CN4	LVDS1 connector
CN5	System FAN connector (Reserved)
CN6	CPU Socket
CN7	CompactFlash connector
CN8	SATA HDD Power connector
CN9	SATA HDD connector
CN10	+V12 power connector
CN11	BIOS Socket connector (Reserved)
CN12	ATX Power Input connector
CN13	USB port 5/6 connector
CN14	MINI PCI connector
CN15	SPI Reflash connector
CN16	Memory Channel A connector
CN17	SATA ODD connector (Reserved)
CN18	SATA ODD Power connector (Reserved)
CN19	Multi Function PCI Express by1 connector
PC1	PCMCIA Slot
CN21	Printer port connector (Reserved)
CN22	LCD Light Sense connector
CN23	Memory Channel B connector
CN24	COM4 connector
CN25	Front Panel LED connector
CN26	COM1 RI Function Selection connector
CN28	LCD Back Light connector
CN29	Power Button connector
CN30	LAN1 RJ45 + USB1/2 connector
CN31	LAN2 RJ45 + USB3/4 connector
CN32	1394 connector (Reserved)
CN33	1394 connector (Reserved)
CN34	VGA D SUB15+ COM3 DSUB9 connector
CN35	Internal Speaker connector
CN36	COM1/2 DSUB9 connector
CN37	MINIDIN PS2 connector
CN38	MIC IN connector
CN39	Line OUT connector
CN40	Line IN connector
CN42	COM2 RI Function Selection connector
CN43	COM3 RI Function Selection connector
CN44	COM4 RI Function Selection connector
CN45	AT Power Solution connector

Table 5.1: CN1 (USB Port 7/8)

Signal	Pin	Pin	Signal
--------	-----	-----	--------

Table 5.1: CN1 (USB Port 7/8)

+V5_USB	1	2	+V5_USB
DAT-	3	4	DAT-
DAT+	5	6	DAT+
GND	7	8	GND
GND	9	10	GND

Table 5.2: CN2 (CPU FAN Connector)

Pin	Signal
1	GND
2	+V12
3	FAN Speed Detection

Table 5.3: CN3 (LVDS2 Connector)

Signal	Pin	Pin	Signal
+5_LVDS0	1	2	+V5_LVDS0
GND	3	4	GND
+V5_LVDS0	5	6	+V5_LVDS0
LVDS2_D0-	7	8	LVDS3_D0-
LVDS2_D0+	9	10	LVDS3_D0+
GND	11	12	GND
LVDS2_D1-	13	14	LVDS3_D1-
LVDS2_D1+	15	16	LVDS3_D1+
GND	17	18	GND
LVDS2_D2-	19	20	LVDS3_D2-
LVDS2_D2+	21	22	LVDS3_D2+
GND	23	24	GND
LVDS2_CLK-	25	26	LVDS3_CLK-
LVDS2_CLK+	27	28	LVDS3_CLK+
GND	29	30	GND
LVDS2_DCLK	31	32	LVDS2_DDCLK
GND	33	34	GND
LVDS2_D3-	35	36	LVDS3_D3-
LVDS2_D3+	37	38	LVDS3_D3+
LVDS2_BKLTEN	39	40	NC

Table 5.4: CN4 (LVDS1 Connector)

Signal	Pin	Pin	Signal
GND	1	2	GND
LVDS0_D0-	3	4	GND
LVDS0_D0+	5	6	GND
LVDS0_D1-	7	8	GND
LVDS0_D1+	9	10	LVDS0_DDAT
LVDS0_D2-	11	12	GND
LVDS0_D2+	13	14	LVDS0_DCLK
LVDS0_CLK-	15	16	GND
LVDS0_CLK+	17	18	NC
+V3.3_LVDS	19	20	+V3.3_LVDS

Table 5.5: CN5 (System FAN Connector)

Pin	Signal
1	GND
2	+V12
3	FAN Speed Detection

Table 5.6: CN8 (SATA HDD Power Connector)

Pin	Signal
1	+V3.3
2	GND
3	+V5
4	GND
5	+V12

Table 5.7: CN9 (SATA HDD Connector)

Pin	Signal
1	GND
2	TX+
3	TX-
4	GND
5	RX-
6	RX+
7	GND

Table 5.8: CN10 (+V12 Power Connector)

Pin	Signal
1	GND
2	GND
3	+V12V
4	+V12V

Table 5.9: CN12 (ATX Power Input Connector)

Signal	Pin	Pin	Signal
+V3.3	1	11	+V3.3
+V3.3	2	12	-V12
GND	3	13	GND
+V5	4	14	PS_ON#
GND	5	15	GND
+V5	6	16	GND
GND	7	17	GND
NC	8	18	NC
+V5SB	9	19	+V5
+V12	10	20	+V5

Table 5.10: CN13 (USB Port 5/6)

Signal	Pin	Pin	Signal
+V5_USB	1	2	+V5_USB
DAT-	3	4	DAT-
DAT+	5	6	DAT+
GND	7	8	GND
GND	9	10	GND

Table 5.11: CN15 (SPI Reflash Connector)

Signal	Pin	Pin	Signal
+V3.3	1	2	GND
CS#	3	4	CLK
MISO#	5	6	MOSI
Key		8	NC

Table 5.12: CN17 (SATA ODD Connector)

Pin	Signal
1	GND
2	TX+
3	TX-
4	GND
5	RX-
6	RX+
7	GND

Table 5.13: CN18 (SATA ODD Power Connector)

Pin	Signal
1	+V3.3
2	GND
3	+V5
4	GND
5	+V12

Table 5.14: CN19 (Multi Function PCI Express by1 Connector)

Signal	Pin	Pin	Signal
+V5	A1	B1	+V12
+V12	A2	B2	+V12
+V12	A3	B3	+V12
GND	A4	B4	GND
SATA1_TX+	A5	B5	SMB_CLK
SATA1_TX-	A6	B6	SMB_DATA
SATA1_RX-	A7	B7	GND
SATA1_RX+	A8	B8	+V3.3
+V3.3	A9	B9	+V5
+V3.3	A10	B10	+V3.3SB
PLTRST#	A11	B11	PCIE_WAKE#
GND	A12	B12	-V12
CLK_PCIE+	A13	B13	GND
CLK_PCIE-	A14	B14	PCIE_TX+
GND	A15	B15	PCIE_TX-
PCIE_RX+	A16	B16	GND
PCIE_RX-	A17	B17	+V5
GND	A18	B18	GND

Table 5.15: CN21 (Printer Port Connector)

Signal	Pin	Pin	Signal
STB	1	2	AFD#
PD0	3	4	ERR#
PD1	5	6	INIT#
PD2	7	8	SLIN#
PD3	9	10	GND
PD4	11	12	GND
PD5	13	14	GND
PD6	15	16	GND
PD7	17	18	GND
ACK#	19	20	GND
BUSY	21	22	GND
PE	23	24	GND
SLCT	25	26	NC

Table 5.16: CN22 (LCD Light Sense Connector)

Pin	Signal
1	+V5
2	SMB_CLK
3	SMB_DATA
4	GND

Table 5.17: CN24 (COM4 Connector)

Signal	Pin	Pin	Signal
DCD#	1	2	RX
TX	3	4	DTR#
GND	5	6	DSR#
RTS#	7	8	CTS#
RI#	9	10	+V5

Table 5.18: CN25 (Front Panel LED Connector)

Pin	Signal
1	+V5
2	HDD_LED
3	LAN1_ACT#
4	LAN2_ACT#
5	GND

Table 5.19: CN26 (COM1 RI Function Selection Connector)

Pin	Signal
1	COM1_RI
2	COM1_RI_Selection
3	+V5
4	COM1_RI_Selection
5	+V12

Table 5.20: CN28 (LCD Back Light Connector)

Pin	Signal
1	+V12
2	+V12
3	GND
4	GND
5	LCD_BKLTEN
6	LCD_VBR
7	LCD_DET

Table 5.21: CN29 (Power Button Connector)

Pin	Signal
1	PANSWIN
2	GND

Table 5.22: CN35 (Internal Speaker Connector)

Pin	Signal
1	OUTA-
2	OUTA+
3	OUTB+
4	OUTB-

Table 5.23: CN37 (MINIDIN PS2 Connector)

Pin	Signal
1	KB_DATA
2	MS_DATA
3	GND
4	+V5
5	KB_CLK
6	MS_CLK

Table 5.24: CN41 (Clear CMOS Connector (Reserved))

Pin	Signal
1	NC
2	RTC_RST#
3	GND

Table 5.25: CN42 (COM2 RI Function Selection Connector)

Pin	Signal
1	COM2_RI
2	COM2_RI_Selection
3	+V5
4	COM2_RI_Selection
5	+V12

Table 5.26: CN43 (COM3 RI Function Selection Connector)

Pin	Signal
1	COM3_RI
2	COM3_RI_Selection
3	+V5
4	COM3_RI_Selection
5	+V12

Table 5.27: CN44 (COM4 RI Function Selection Connector)

Pin	Signal
1	COM4_RI
2	COM4_RI_Selection
3	+V5
4	COM4_RI_Selection
5	+V12

Table 5.28: CN45 (AT Power Solution Connector)

Pin	Signal
1	NC
2	But_PANSWIN
3	PANSWIN

5.1.5 Jumper Settings

Table 5.29: CN26 (COM1 RI Function Selection Connector)

(1-2)	Ring Function (default)
(3-4)	Ring output 5V
(4-5)	Ring output 12V

Table 5.30: CN42 (COM3 RI Function Selection Connector)

(1-2)	Ring Function (default)
(3-4)	Ring output 5 V
(4-5)	Ring output 12 V

Table 5.31: CN43 (COM4 RI Function Selection Connector)

(1-2)	Ring Function (default)
(3-4)	Ring output 5 V
(4-5)	Ring output 12 V

Table 5.32: CN44 (COM2 RI Function Selection Connector)

(1-2)	Ring Function (default)
(3-4)	Ring output 5 V
(4-5)	Ring output 12 V

Table 5.33: CN45 (AT Power Selection)

(1-2)	ATX power supply (default)
(2-3)	AT power supply

Chapter 6

Driver Installation

This chapter gives information on installing drivers for the PPC-177T.

Sections include:

- Driver Installation
- Updating Drivers

6.1 Introduction

A Driver CD is supplied inside the accessory box. Customers may need to use an external USB CD-ROM related device to load the CD and install the drivers for the PPC-177T.

6.1.1 Driver Installation

Before installing the Ethernet driver, note the procedures below. It is necessary to know which operating system is installed on the PPC-177T. Then refer to the corresponding installation flow chart. Follow the steps described in the flow chart to complete the installation quickly. Drivers and documents included on the CD are for the chipset, LAN, Audio, Touchscreen, VGA, USB and a PDF copy of this user manual.

- Note!**
1. *The CD-ROM drive is designated as "D" throughout this chapter.*
 2. *<Enter> means pressing the "Enter" key on the keyboard.*



6.2 Updating Driver Search on the Advantech Website

For further information about installing drivers on the PPC-177T, and to access driver updates, troubleshooting guides and FAQ lists, visit the following web resources:

Advantech websites:

www.advantech.com

www.advantech.com.tw

Appendix **A**

PCI Card and PCI-E Size Limits

This chapter details the size limits for PCI and PCI-E cards that may be installed on the Panel PC motherboard.

A.1 PCI Interface Card

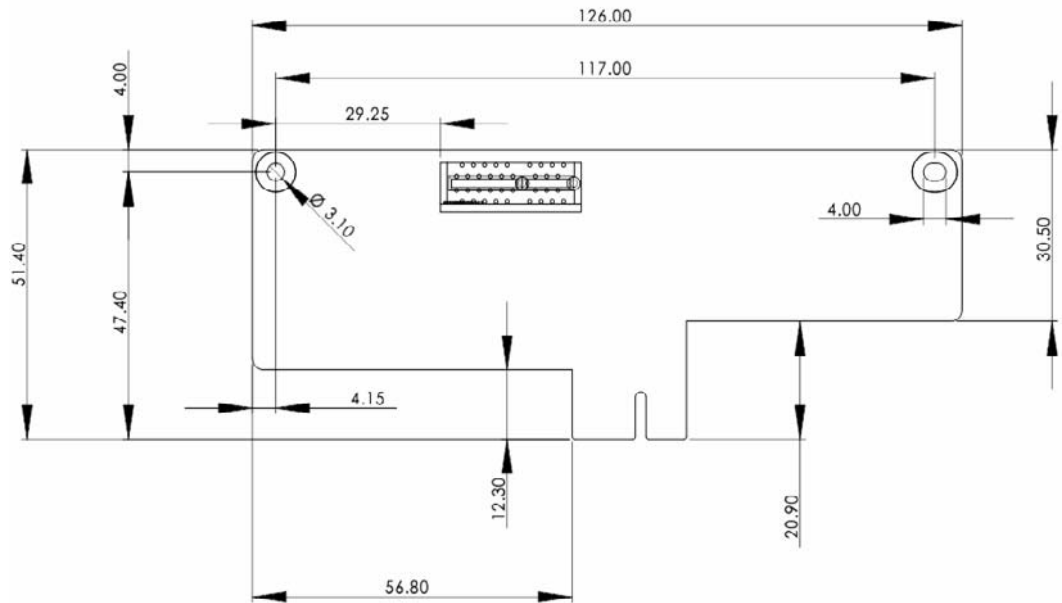

A.2 PCI-E Interface Card

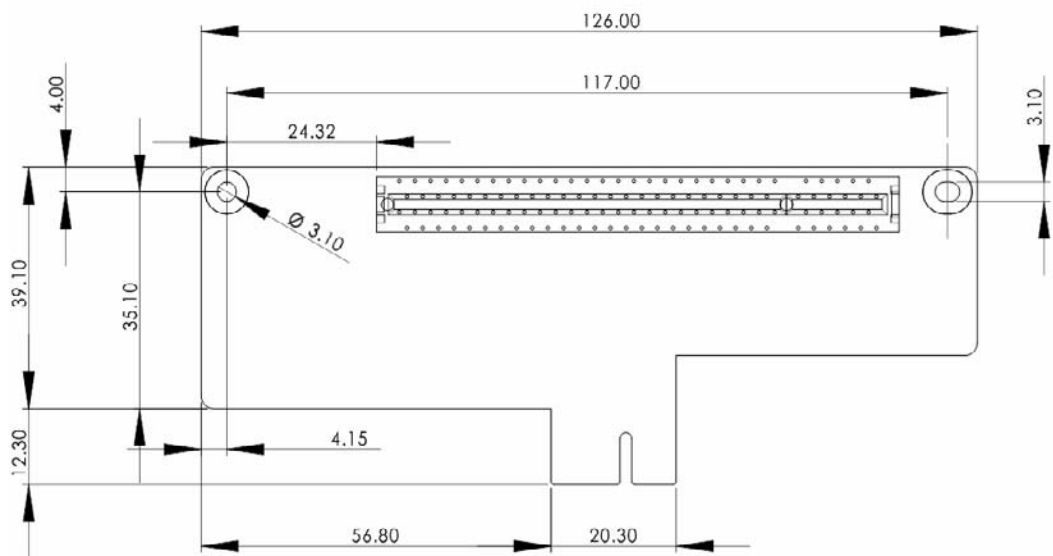

Trusted ePlatform Services

ADVANTECH

www.advantech.com

Please verify specifications before quoting. This guide is intended for reference purposes only.

All product specifications are subject to change without notice.

No part of this publication may be reproduced in any form or by any means, electronic, photocopying, recording or otherwise, without prior written permission of the publisher.

All brand and product names are trademarks or registered trademarks of their respective companies.

© Advantech Co., Ltd. 2009