

## **PPC-103**

Celeron®/Pentium™III Panel PC  
with 10.4" LCD flat panel display

## **Copyright Notice**

This document is copyrighted 2000 by Advantech Co. Ltd. All rights are reserved. Advantech Co., Ltd. reserves the right to make improvements to the products described in this manual at any time without notice.

No part of this manual may be reproduced, copied, translated or transmitted in any form or by any means without the prior written permission of Advantech. Information provided in this manual is intended to be accurate and reliable. However, Advantech assumes no responsibility for its use, nor for any infringements upon the rights of third parties which may result from its use.

All brand and product names mentioned herein are trademarks or registered trademarks of their respective holders.

Part No. 2002010300, 1st Edition  
Printed in Taiwan  
December 2000

## **FCC Class B**

This equipment has been tested and found to comply with the limits for a Class B digital device, pursuant to Part 15 of the FCC Rules. These limits are designed to provide reasonable protection against harmful interference when the equipment is operated in a residential environment. This equipment generates, uses and can radiate radio frequency energy. If not installed and used in accordance with this user's manual, it may cause harmful interference to radio communications. Note that even when this equipment is installed and used in accordance with this user's manual, there is still no guarantee that interference will not occur. If this equipment is believed to be causing harmful interference to radio or television reception, this can be determined by turning the equipment on and off. If the interference is occurring, the user is encouraged to try to correct the interference by one or more of the following measures:

- Reorient or relocate the receiving antenna
- Increase the separation between the equipment and the receiver
- Connect the equipment to a power outlet on a circuit different from that to which the receiver is connected
- Consult the dealer or an experienced radio/TV technician for help

***Warning: Any changes or modifications made to the equipment which are not expressly approved by the relevant standards authority could void your authority to operate the equipment.***

# Packing List

---

Before installing your panel PC, ensure that the following materials have been received:

- PPC-103 series panel PC
- User's manual
- Accessories for PPC-103
  - Power cable for both FDD and HDD/CD-ROM
  - FDD flat cable (35 cm)
  - Keyboard extension cable (5-pin DIN female to 6-pin PS/2 male)
  - FDD power cable
  - HDD flat cable (44-pin) (5 cm)
  - IDE flat cable (40-pin) (46 cm)
  - Audio line-in cable
  - Power cord (1.8 m) - USA type
  - Mounting kits and packet of screws
  - Heat sink
  - HDD bracket
  - Driver/Utility CD-ROM disk
  - Screws
  - Silicon heat sink paste
  - CPU push cover
  - CPU push screw driver
  - Warranty card
  - CPU top plate for FPCGA type CPU

If any of these items are missing or damaged, contact your distributor or sales representative immediately.

**Note:**

1. Customers may buy the CPU separately. Do not buy a CPU that already has a fan attached with adhesive, because it is not easy to remove such fan.

If you install or upgrade a CPU yourself, you must install the heat sink assembly from Advantech above the CPU in order to avoid heat damage to the CPU. The CPU and the heat sink are normally sold

together with the fan attached to the CPU. Due to tight constraints within the PPC-103's housing, care must be taken to use the heat sink in the accessory box which will both cool the CPU and fit within the PPC-103. Thus you must buy a CPU without a fan attached.

## **Additional Information and Assistance**

---

1. Visit the Advantech Web site at **[www.advantech.com](http://www.advantech.com)** where you can find the latest information about the product.
2. Contact your distributor, sales representative, or Advantech's customer service center for technical support if you need additional assistance. Please have the following information ready:
  - Product name and serial number
  - Description of your peripheral attachments
  - Description of your software (operating system, version, application software, etc.)
  - A complete description of the problem
  - The exact wording of any error messages

# Safety Instructions

---

1. Please read these safety instructions carefully.
2. Please keep this User's Manual for later reference.
3. Please disconnect this equipment from any AC outlet before cleaning. Do not use liquid or spray detergents for cleaning. Use a damp cloth.
4. For pluggable equipment, the socket-outlet must be installed near the equipment and must be easily accessible.
5. Please keep this equipment away from humidity.
6. Put this equipment on a reliable surface during installation. Dropping it or letting it fall could cause damage.
7. The openings on the enclosure are for air convection. Protect the equipment from overheating. **DO NOT COVER THE OPENINGS.**
8. Make sure the voltage of the power source is correct before connecting the equipment to the power outlet.
9. Position the power cord so that people cannot step on it. Do not place anything over the power cord.
10. All cautions and warnings on the equipment should be noted.
11. If the equipment is not used for a long time, disconnect it from the power source to avoid damage by transient overvoltage.
12. Never pour any liquid into an opening. This could cause fire or electrical shock.
13. Never open the equipment. For safety reasons, the equipment should be opened only by qualified service personnel.
14. If one of the following situations arises, get the equipment checked by service personnel:
  - a. The power cord or plug is damaged.
  - b. Liquid has penetrated into the equipment.
  - c. The equipment has been exposed to moisture.
  - d. The equipment does not work well, or you cannot get it to work according to the user's manual.
  - e. The equipment has been dropped and damaged.
  - f. The equipment has obvious signs of breakage.
15. **DO NOT LEAVE THIS EQUIPMENT IN AN UNCONTROLLED ENVIRONMENT WHERE THE STORAGE TEMPERATURE IS BELOW -20° C (-4° F) OR ABOVE 60° C (140° F). IT MAY DAMAGE THE EQUIPMENT.**

The sound pressure level at the operator's position according to IEC 704-1:1982 is equal to or less than 70 dB(A).

**DISCLAIMER:** This set of instructions is given according to IEC 704-1. Advantech disclaims all responsibility for the accuracy of any statements contained herein.

# Wichtige Sicherheitshinweise

---

1. Bitte lesen Sie sich diese Hinweise sorgfältig durch.
2. Heben Sie diese Anleitung für den späteren Gebrauch auf.
3. Vor jedem Reinigen ist das Gerät vom Stromnetz zu trennen. Verwenden Sie keine Flüssig- oder Aerosolreiniger. Am besten dient ein angefeuchtetes Tuch zur Reinigung.
4. Die Netzanschlusstekdose soll nahe dem Gerät angebracht und leicht zugänglich sein.
5. Das Gerät ist vor Feuchtigkeit zu schützen.
6. Bei der Aufstellung des Gerätes ist auf sicheren Stand zu achten. Ein Kippen oder Fallen könnte Verletzungen hervorrufen.
7. Die Belüftungsöffnungen dienen zur Luftzirkulation die das Gerät vor Überhitzung schützt. Sorgen Sie dafür, daß diese Öffnungen nicht abgedeckt werden.
8. Beachten Sie beim Anschluß an das Stromnetz die Anschlußwerte.
9. Verlegen Sie die Netzanschlußleitung so, daß niemand darüber fallen kann. Es sollte auch nichts auf der Leitung abgestellt werden.
10. Alle Hinweise und Warnungen die sich an Geräten befinden sind zu beachten.
11. Wird das Gerät über einen längeren Zeitraum nicht benutzt, sollten Sie es vom Stromnetz trennen. Somit wird im Falle einer Überspannung eine Beschädigung vermieden.
12. Durch die Lüftungsöffnungen dürfen niemals Gegenstände oder Flüssigkeiten in das Gerät gelangen. Dies könnte einen Brand bzw. elektrischen Schlag auslösen.
13. Öffnen Sie niemals das Gerät. Das Gerät darf aus Gründen der elektrischen Sicherheit nur von autorisiertem Servicepersonal geöffnet werden.
14. Wenn folgende Situationen auftreten ist das Gerät vom Stromnetz zu trennen und von einer qualifizierten Servicestelle zu überprüfen:
  - a - Netzkabel oder Netzstecker sind beschädigt.
  - b - Flüssigkeit ist in das Gerät eingedrungen.
  - c - Das Gerät war Feuchtigkeit ausgesetzt.
  - d - Wenn das Gerät nicht der Bedienungsanleitung entsprechend funktioniert oder Sie mit Hilfe dieser Anleitung keine Verbesserung erzielen.
  - e - Das Gerät ist gefallen und/oder das Gehäuse ist beschädigt.
  - f - Wenn das Gerät deutliche Anzeichen eines Defektes aufweist.

Der arbeitsplatzbezogene Schalldruckpegel nach DIN 45 635 Teil 1000 beträgt 70 dB(A) oder weniger.

DISCLAIMER: This set of instructions is given according to IEC704-1. Advantech disclaims all responsibility for the accuracy of any statements contained herein.

# Contents

<b>Chapter 1 General Information</b> .....	<b>1</b>
<b>1.1 Introduction</b> .....	<b>2</b>
<b>1.2 Specifications</b> .....	<b>3</b>
<b>1.3 General</b> .....	<b>3</b>
<b>1.4 Interface Standard PC functions</b> .....	<b>3</b>
<b>1.5 I/O Arrangement</b> .....	<b>8</b>
<b>1.6 Cutout (Suggestion)</b> .....	<b>9</b>
<b>1.7 Mounting</b> .....	<b>10</b>
1.7.1 Panel mounting .....	10
1.7.2 Desktop stand (optional) .....	11
1.7.3 Wall-mounting (optional) .....	12
<b>Chapter 2 System Setup</b> .....	<b>13</b>
<b>2.1 General</b> .....	<b>14</b>
<b>2.2 Removing Rear Panel</b> .....	<b>15</b>
<b>2.3 Installing Options</b> .....	<b>16</b>
2.3.1 Installing CPU and heat sink assembly .....	16
2.3.2 Installing a primary 2.5" HDD (internal) .....	19
2.3.3 Installing the SDRAM Memory Module .....	24
2.3.4 Installing an FDD .....	26
<b>2.4 Installing I/O Equipment</b> .....	<b>26</b>
2.4.1 Installing one secondary HDD/CD-ROM device (external) ..	26
2.4.3 Parallel port connection .....	27
2.4.4 PS/2 keyboard and PS/2 mouse .....	27
2.4.5 Mic-in, line-out .....	28
2.4.6 External VGA .....	29
2.4.7 Four serial COM ports .....	29
2.4.8 Ethernet .....	29

<b>2.5 Installing Software to the HDD .....</b>	<b>30</b>
2.5.1 Method 1: Use the Ethernet .....	30
2.5.2 Method 2: Use an FDD .....	30
2.5.3 Method 3: Use the COM or parallel port .....	30
2.5.4 Method 4: Use a 3.5" HDD or CD-ROM .....	30
<b>2.6 Exploded Diagram .....</b>	<b>31</b>
<b>2.7 PCM-9573 and I/O Adapter Replacement .....</b>	<b>33</b>
<b>2.8 Power Supply and Cooling Fan Replacement .....</b>	<b>34</b>

**Chapter 3 Jumper Settings and Connectors .....** **37**

<b>3.1 Jumpers and Connectors .....</b>	<b>38</b>
3.1.1 Setting jumpers .....	38
3.1.2 Jumpers and switch .....	39
3.1.3 Locating jumpers and switch .....	40
3.1.4 Connectors .....	41
3.1.5 Locating connectors .....	42
<b>3.3 CMOS Clear for External RTC (JP7) .....</b>	<b>43</b>
<b>3.4 COM-port Interface .....</b>	<b>43</b>
3.4.1 COM2 RS-232/422/485 setting (JP2, JP3, JP4) .....	43
3.4.2 COM3 / COM4 pin 9 output type setting (JP5) .....	45
<b>3.5 VGA Interface .....</b>	<b>45</b>
3.5.1 LCD panel power setting .....	45
3.5.2 Panel type select (SW1) .....	45
<b>3.6 Watchdog Timer Configuration .....</b>	<b>46</b>
3.6.1 Watchdog activity selection (JP6) .....	46

**Chapter 4 Award BIOS Setup .....** **47**

<b>4.1 Award BIOS Setup .....</b>	<b>48</b>
-----------------------------------	-----------

<b>4.2 CMOS Setup Utility .....</b>	<b>48</b>
<b>4.3 Standard CMOS Setup .....</b>	<b>49</b>
4.3.1 Hard disk configurations .....	49
<b>4.4 BIOS Features Setup .....</b>	<b>51</b>
<b>4.5 Chipset Features Setup .....</b>	<b>54</b>
<b>4.6 Power Management Setup .....</b>	<b>57</b>
<b>4.7 PNP/PCI Configuration Setup.....</b>	<b>59</b>
<b>4.8 Load BIOS Defaults .....</b>	<b>60</b>
<b>4.9 Load Setup Defaults .....</b>	<b>61</b>
<b>4.10 Integrated Peripherals .....</b>	<b>61</b>
<b>4.11 Password Setting .....</b>	<b>63</b>
<b>4.12 IDE HDD Auto Detection .....</b>	<b>64</b>
<b>4.13 Save and Exit Setup .....</b>	<b>65</b>
<b>4.14 Exit Without Saving.....</b>	<b>65</b>
<b>CHAPTER 5 PCI Bus Ethernet Interface.....</b>	<b>67</b>
<b>5.1 Introduction .....</b>	<b>68</b>
<b>5.2 Installation of Ethernet Driver .....</b>	<b>68</b>
5.2.1 Installation for Windows 95 .....	69
5.2.2 Installation for Windows 98 .....	72
5.2.3 Installation for Windows NT .....	76
<b>5.3 Further Information .....</b>	<b>78</b>
<b>Chapter 6 PCI SVGA Setup .....</b>	<b>79</b>
<b>6.1 Introduction .....</b>	<b>80</b>
6.1.1 Chipset .....	80
6.1.2 Display memory .....	80
6.1.3 Display types .....	80
<b>6.2 Installation of SVGA Driver .....</b>	<b>80</b>

6.2.1 Installation for Windows 95 .....	82
6.2.2 Installation for Windows 98 .....	83
6.2.3 Installation for Windows NT .....	84
6.2.4 Installation for Windows 2000 .....	85
<b>6.3 Further Information .....</b>	<b>86</b>

<b>Chapter 7 Audio .....</b>	<b>87</b>
<b>7.1 Introduction .....</b>	<b>88</b>
<b>7.2 Installation of Audio Driver .....</b>	<b>88</b>
7.2.1 Installation for Windows 95/98 .....	89
7.2.2 Installation for Windows NT .....	91
7.2.3 Installation for Windows 2000 .....	94

<b>CHAPTER 8 Touchscreen .....</b>	<b>97</b>
<b>8.1 Introduction .....</b>	<b>98</b>
<b>8.1.1 General information .....</b>	<b>98</b>
8.1.2 General specifications .....	98
8.1.3 Environmental specifications .....	98
<b>8.2 Installation of Driver for Resistive or SAW Touchscreen .....</b>	<b>99</b>
8.2.1 Installation for Windows 95 .....	100
8.2.2 Installation for Windows 98 .....	102
8.2.3 Installation for Windows NT .....	104
8.2.4 Installation for Windows 2000 .....	107

<b>Appendix A Programming the Watchdog Timer .....</b>	<b>111</b>
<b>A.1 Programming the Watchdog Timer .....</b>	<b>112</b>

<b>Appendix B Power Supply Specifications .....</b>	<b>113</b>
---	------------

**B.1 Introduction ..... 114**  
**B.2 Input Specifications ..... 114**  
**B.3 Output Specifications ..... 114**  
**B.4 Mechanical Specifications ..... 115**  
**B.5 Environmental Specifications ..... 116**  
**B.6 Features ..... 116**  
International standards ..... 116

**APPENDIX C I/O Pin Assignments ..... 119**  
Keyboard connector (CN5-1) ..... 120  
Mouse connector (CN5-2) ..... 120  
VGA connector (CN6) ..... 121  
COM1 RS-232 serial port (CN1-2) ..... 121  
COM3 RS-232 serial port (CN2-1) ..... 122  
COM4 RS-232 serial port (CN2-2) ..... 122  
Parallel port connector (CN1-1) ..... 124

# Figures

<i>Figure 1-1: PPC-103 panel PC dimensions</i> .....	7
<i>Figure 1-2: PPC-103 back panel I/O arrangement and cable connections</i> .....	89
<i>Figure 1-3: PPC-103 panel mounting cutout dimensions</i> .....	9
<i>Figure 1-4: PPC-103 rear panel mounting brackets</i> .....	
<i>Figure 1-5: PPC-103 rear panel mounting brackets</i> .....	10
<i>Figure 1-6: PPC-103 desktop stand</i> .....	11
<i>Figure 1-7: PPC-103 wall mounting configuration</i> .....	12
<i>Figure 2-1: Removing the PPC-103's rear panel</i> .....	156
<i>Figure 2-2: Fan cooling with heatsink assembly installation</i> .....	17
<i>Figure 2-3: Place CPU push cover over CPU</i> .....	19
<i>Figure 2-4: Insert screw driver into the hole</i> .....	19
<i>Figure 2-5: Push CPU in position</i> .....	19
<i>Figure 2-6: CPU installation</i> .....	20
<i>Figure 2-7: HDD Assembly</i> .....	21
<i>Figure 2-8: Rubber screwed onto the hard disk</i> .....	22
<i>Figure 2-9: Connect flat cable to the HDD</i> .....	22
<i>Figure 2-10: Assemble HDD brackets</i> .....	24
<i>Figure 2-11: PPC-103 exploded diagram</i> .....	31
<i>Figure 2-12: Installing/removing the PCM-9573 in the PPC-103</i> .....	33
<i>Figure 2-13: Installing/removing the I/O adapter in the PPC-103</i> .....	32
<i>Figure 2-14: Replacing the power supply</i> .....	34
<i>Figure 2-15: Replacing the cooling fan</i> .....	35
<i>Figure 3-1: Jumpers on the PPC-103 motherboard</i> .....	40
<i>Figure 3-2: Locating connectors on the PPC-103 motherboard</i> .....	42
<i>Figure 4-1: Setup program initial screen</i> .....	48
<i>Figure 4-2: CMOS setup screen</i> .....	49
<i>Figure 4-3: BIOS features setup screen</i> .....	51
<i>Figure 4-4: Chipset features setup screen</i> .....	55
<i>Figure 4-5: Power management setup screen</i> .....	57
<i>Figure 4-6: PNP/PCI configuration setup screen</i> .....	59
<i>Figure 4-7: Load BIOS defaults screen</i> .....	60
<i>Figure 4-8: Integrated peripherals screen</i> .....	61

*Figure 4-9: IDE HDD auto detection screen ..... 64*  
*Figure 4-10: Save and exit setup screen ..... 65*  
*Figure B-a: PPC-103 dimensions diagram ..... 115*

# Tables

<i>Table 1-1: PPC-103 series LCD specifications</i> .....	6
<i>Table 3-1: Jumpers and their functions</i> .....	39
<i>Table 3-2: Connectors on the PPC-103 motherboard</i> .....	41
<i>Table 3-3: Clear CMOS / External RTC (JP7)</i> .....	43
<i>Table 3-4: COM2 RS-232/422/485 setting (JP2, JP3)</i> .....	43
<i>Table 3-5: COM2 RS-232/422/485 setting (JP4)</i> .....	44
<i>Table 3-6: Serial port default settings</i> .....	44
<i>Table 3-7: COM3/COM4 pin 9 setting (JP5)</i> .....	45
<i>Table 3-10: Panel type select (SW1)</i> .....	46
<i>Table 3-11: Watchdog activity selection (JP6)</i> .....	46



# CHAPTER 1

## **General Information**

This chapter gives background information on the PPC-103.

Sections include:

- Introduction
- Specifications
- LCD Specifications
- Dimensions
- I/O Arrangement
- Cutout (Suggestion)
- Mounting

## 1.1 Introduction

The PPC-103 panel PC is a multimedia Celeron™/Pentium® III processor-based industrial computer that is designed to serve as a human machine interface (HMI). It is a PC-based system with 10.4" color TFT or DSTN LCD display, on-board PCI Ethernet, multi-COM port interfaces, and a 16-bit audio controller. This simple, complete, compact and highly integrated multimedia system lets you easily build a panel PC into your applications. By incorporating the PPC-103 into your project, your product development time will be shortened.

The PPC-103 is a compact, network-compatible PC with extensive features to control a dedicated system in a wide variety of applications. Common industrial applications include factory automation systems, precision machinery, and production process control. It is also suitable for many nonindustrial applications, including terminal information systems, entertainment management systems, and car park automation systems. Our panel PC is a reliable, cost-effective solution to your application's processing requirements.

## 1.2 Specifications

### General

- **Dimensions (W x H x D):** 342 x 265 x 61.5 mm (13.5"x10.4"x2.4")
- **Weight:** 3.5 kg (7.7 lbs)
- **Power supply:** 60 watts  
Input voltage: 100 V<sub>AC</sub>/2 A  
250 V<sub>AC</sub>/1A @ 50 ~ 60 Hz  
Output voltage: +5 V @ 6 A, +12 V @ 3 A
- **MTBF:** 50,000 hrs
- **Safety:** UL/CSA/TUV approved
- **Disk drive housing:** Space for one internal 2.5" HDD
- **Front panel:** IP65 protection

### Standard PC functions

- **CPU:** Intel Celeron™ or Pentium® III (PGA 370 socket)

- **BIOS:** AWARD 256KB Flash BIOS, supports Plug & Play, APM v1.2
- **Chipset:** Intel 82443BX/82371EB
- **2nd level cache:** 128 KB on CPU
- **RAM:** Two 144-pin SODIMM sockets accept 16~256MB SDRAM
- **PCI Bus Master IDE interface:** Supports two connectors (one internal, one external extension). Each connector supports two IDE devices on two channels (PIO modes 3/4). BIOS supports IDE CD-ROM boot-up and enable/disable
- **Floppy disk drive interface:** Supports one external FDD  
(360K/1.2MB/720K/1.44MB/2.88 MB)
- **Parallel port:** One parallel port, supports SPP/EPP/ECP parallel mode.
- **Serial ports:** Four serial ports with three RS-232 ports (COM1, 3, and 4), one RS-232/422/485 port (COM2). All ports with 16C550 compatible UARTs.
- **USB:** Supports two UHCI USB
- **Watchdog timer:** 62-level interval from 1 to 62 seconds. Automatically generates system reset or IRQ11 when the system stops due to a program error or EMI. Jumperless selection and software enabled/disabled.
- **Battery:** 3.6 V @ 600 mA lithium battery

### **Solid State Disk (SSD)**

- **One 50-pin socket:** For one CompactFlash™ card, shared with one IDE channel.

### **PCI SVGA/flat panel interface**

- **Chipset:** SMI Lynx EM4+
- **Display memory:** 4MB on-die
- **Display type:** Simultaneously supports CRT and flat panel (EL, LCD and gas plasma) displays
- **Display resolution:** Supports non-interlaced CRT and LCD displays up to 1024 x 768 @ 16M colors with 4 MB on-board display memory

### **Audio function:**

- **Chipset:** ESS 1938 (PCI)
- **Audio controller:** 16-bit codec, Sound Blaster Pro compatible
- **Stereo sound:** Full-duplex monophonic mode, half-duplex stereo mode
- **Audio interface:** Microphone-in, Line out

### **PCI bus Ethernet interface**

- **Chipset:** REALTEK RTL 8139 PCI local bus Ethernet controller
- **Ethernet interface:** Full compliance with IEEE 802.3u 100Base-T and 10Base-T specifications. Includes software drivers and boot ROM

### **Touchscreen (optional)**

- **Type:** Analog resistive
- **Resolution:** Continuous
- **Light transmission:** 75% (Surface meets ASTM-D-1044 standard, Taber Abrasion Test)
- **Controller:** RS-232 interface (uses COM4)
- **Power consumption:** +5 V @ 200 mA
- **Software driver:** Supports DOS, Windows 95/98, Windows NT and Windows 2000
- **Durability:** 30 million touch lifetime

\*\*Note: The PPC-103 with the optionally installed touchscreen will share COM4.

### **Optional modules**

- **CPU:** Intel Celeron or Pentium III
- **Memory:** 16/32/64/128/256 MB SODRAM
- **HDD:** 2.5" HDD
- **Operating system:** Windows 95/98, Windows NT, DOS, Windows 2000
- **Touchscreen:** Analog resistive

### **Environment**

- **Temperature:** 0° ~ 45° C (32° ~ 113° F)
- **Relative humidity:** 10 ~ 95% @ 40 °C, non-condensing
- **Shock:** 10G peak acceleration (11 msec duration)
- **Power MTBF:** 50,000 hrs
- **Certification:** Passed CE, FCC Class B, VCCI certification

### 1.3 LCD Specifications

*Table 1-1: PPC-103 series LCD specifications*

Model	PPC-103T	PPC-103S
Display type (LCD)	10.4" SVGA TFT	10.4" VGA DSTN
LCD model	Toshiba LTM10C273 or compatibles	Kyocera KCB104VG2C-A43 or compatibles
Max. resolution	800 x 600	640 x 480
Colors	256 K colors	256 K colors
Dot size (mm)	0.33 x 0.33	0.33 x 0.33
View angle	120	90
Luminance	250 cd/m†	130 cd/m†
Temperature	0 ~ 50 C	0 ~ 45 C
VR controls	N/A	Contrast
Simultaneous mode	Yes	Yes
LCD MTBF	50,000 hours	50,000 hours
Backlight MTBF	20,000 hours	25,000 hours

# 1.4 Dimensions

Unit: mm

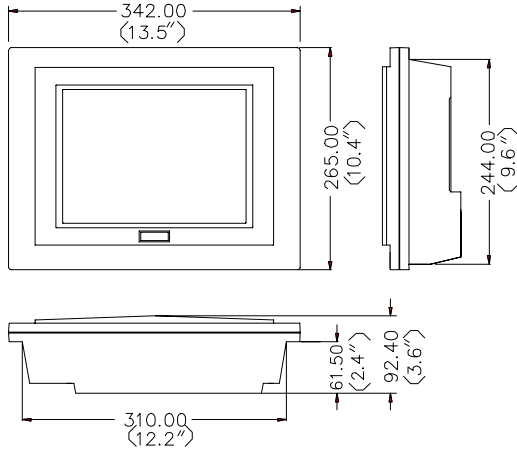
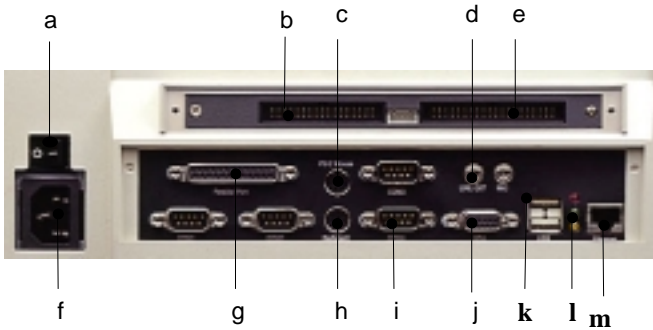

Figure 1-1: PPC-103 panel PC dimensions

## 1.5 I/O Arrangement



- |                         |                       |
|-------------------------|-----------------------|
| a. Power switch         | h. Keyboard connector |
| b. FDD port             | i. COM port           |
| c. PS/2 mouse connector | j. VGA port           |
| d. Line out port        | k. USB port           |
| e. External IDE port    | l. Light indicator    |
| f. AC inlet             | m. Ethernet port      |
| g. Parallel port        |                       |

\* Three RS-232 (COM1, 3, 4) and one RS-232/422/485 (COM2)

*Figure 1-2: PPC-103 back panel I/O arrangement and cable connections*

## 1.6 Cutout (Suggestion)

The PPC-103 will stand on a shelf or a table, or you can mount it into a panel. Cutout panel dimensions are as follows:

### Cutout for panel mount

*Unit: mm*

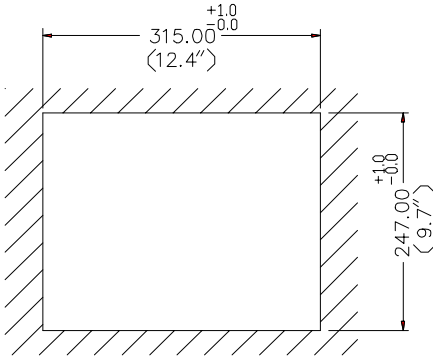

*Figure 1-3: PPC-103 panel mounting cutout dimensions*

## 1.7 Mounting

### 1.7.1 Panel mounting

If you decide to use a cutout within a panel to mount your PPC-103, we have included two panel-mount brackets. The brackets have two screws that fit in the keyhole slots on the panel PC.

Slide the PPC-103 backwards into the panel opening. Attach the two mounting brackets by sliding the two screw heads into the keyhole slots on the rear cover. Secure the PPC-103 against the back of the panel opening.

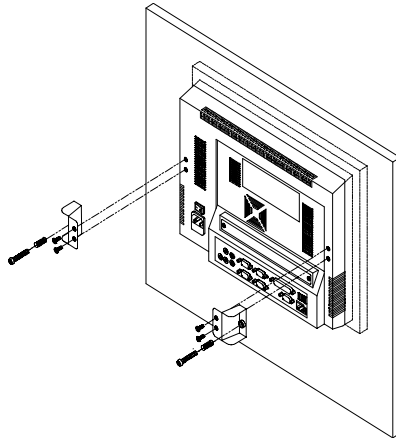

*Figure 1-5: PPC-103 rear panel mounting brackets*

## 1.7.2 Desktop stand (optional)

An optional stand is available for mounting the PPC as a desktop PC. The PPC-103 slides into the stand and is held in place by the screws provided. The compactness of the desktop-mounted PPC-103 saves desk space.



*Figure 1-6: PPC-103 desktop stand*

### 1.7.3 Wall-mounting (optional)

An optional wall-mounting attachment is also available for mounting the PPC at approximately 45° to a flat surface. Installation instructions follow:

1. The wall-mounting attachment is comprised of three parts: one back bracket, one support bracket, and one mounting bracket.
2. First attach the back bracket to the rear cover of the PPC-103, securing it in place with four of the philips-head screws provided.
3. Using a flat-head screwdriver, attach the support bracket to the back bracket using four of the flat-head screws provided, two on either side of the support bracket. The sides of the support bracket should overlap the sides of the back bracket, and the screws should secure one bracket to the other through the existing holes drilled into each bracket.
4. Mount the mounting bracket on the wall or other flat surface. The support bracket slides vertically from the top into the mounting bracket. It can then be secured to the mounting bracket by screwing one of the philips-head screws provided through the corresponding holes at the tops of the mounting bracket and the support bracket.



*Figure 1-7: PPC-103 wall mounting configuration*



# CHAPTER 2

## **System Setup**

- General
- Removing Rear Panel
- Installing Options
- Installing I/O Equipment
- Installing Software to the HDD
- Exploded Diagram
- PCM-9573 and I/O Adapter Replacement
- Power Supply and Cooling Fan Replacement

## 2.1 General

The PPC-103 consists of a PC-based industrial computer that is housed in a protective cover. Your HDD, SDRAM, power supply and CPU are all readily accessible by removing the rear panel. Any maintenance or hardware upgrades can be carried out easily after removing the rear panel.

*Warning! Do not remove the rear cover until you have verified that no power is flowing within the PPC-103. Power must be switched off, and the power cord must be disconnected. Every time you service the PPC-103, you should be aware of this.*



## 2.2 Removing Rear Panel

Unscrew the eleven screws that secure the rear cover, then remove the cover.

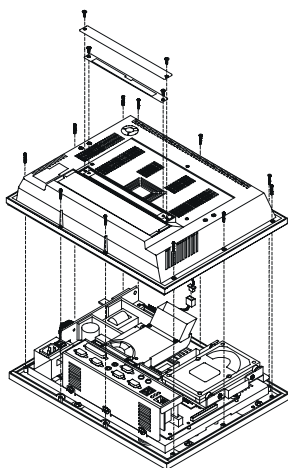

*Figure 2-1: Removing the PPC-103's rear panel*

Because the CPU socket is fragile, only qualified engineers can install the CPU. If the customer breaks the CPU socket, Advantech is not responsible for the failure of this assembly,

## 2.3 Installing Options

### 2.3.1 Installing CPU and heat sink assembly

The PPC-103's CPU (Central Processing Unit) can be upgraded to improve system performance. The PPC-103 provide one 370 socket. The heat sink assembly which comes with the machine must be installed to prevent overheating. If the CPU is type FC-PGA, the CPU metal plate which comes in the accessory box must be installed on the top of the CPU as shown in Figure 2-2.

*Warning! The CPU may be damaged if operated without the heat sink assembly*



**Caution!** When buying a CPU, do not include a fan and do not apply thermal jelly to the CPU for fan installation. The compact size of the PPC-103 prevents using a fan.

*Warning! Always disconnect the power cord from your PPC-103 when you are working on it. DO not make connections while the power is on as sensitive electronic components can be damaged by the sudden rush of power. Only experienced electronics personnel should open the PPC-103.*



1. Turn off the PPC-103 and remove the rear cover.
2. Remove the heat sink assembly by removing four screws.
3. Insert the CPU in the correct orientation and gently slide the CPU in. It should insert easily. Make sure the pin of the CPU corresponds with the hole of the socket. Do not use excessive force !
4. Place the metal CPU push cover on the top of the CPU as

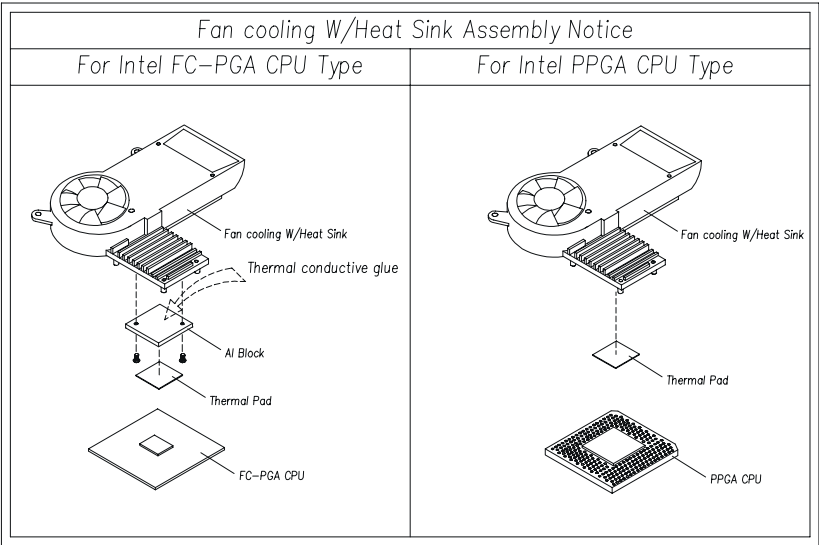
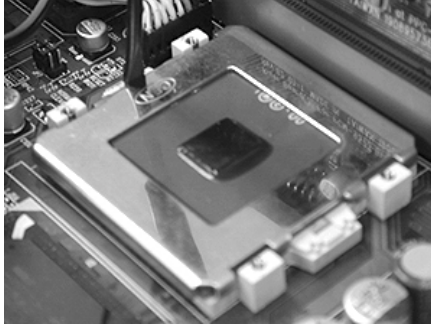

Figure 2-2: Fan cooling with heatsink assembly installation

shown in Figure 2-3.



*Figure 2-3: Place CPU push cover over CPU*

5. Insert the flat-headed screwdriver into the side hole of the CPU upward perpendicular to the CPU as shown in Figure 2-4. Make sure the slightly bent screw driver head is pointing outward.



*Figure 2-4: Insert screw driver into the hole*

6. Gently levering at the CPU push cover by pushing the top end of the screwdriver away from the CPU (Figure 2-5, 2-6). After the CPU has been secured in the right position, remove the screw driver and the CPU push cover.

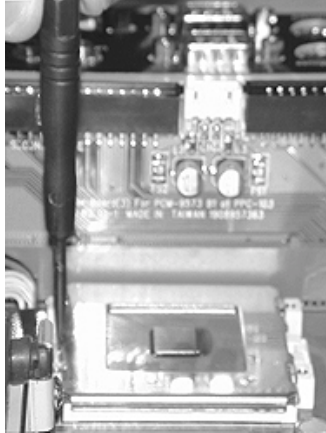
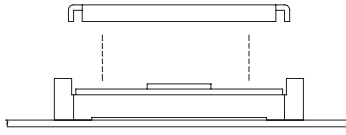

*Figure 2-5: Push CPU in position*

7. If the CPU to be installed is Type FC-PGA. A CPU metal plate must be installed. First apply a even thickness of the silicone heat sink paste on the top of the CPU. The CPU metal top plate is then placed on the top of the paste (Figure 2-2).
8. Put the heat sink assembly back and tighten the screws.

### **2.3.2 Installing a primary 2.5” HDD (internal)**

You can attach one enhanced Integrated Device Electronics (IDE) hard disk drive to the PPC-103’s internal controller which uses a PCI local bus interface. The advanced IDE controller supports faster data transfer rates and allows the IDE hard disk drive to exceed 528 1. Use the four screws in



Put the CPU push cover on CPU socket.

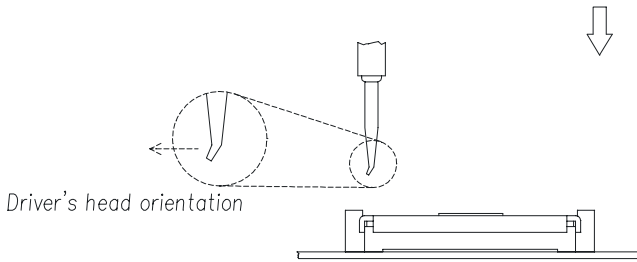

Please notice the driver's orientation, no matter locking or unlocking CPU, the driver head always orient to outside of CPU socket.

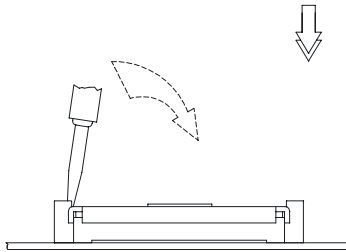

The force-used oriented.

*Figure 2-6: CPU installation*

MB. The following are instructions for installation (Figure 2-7).

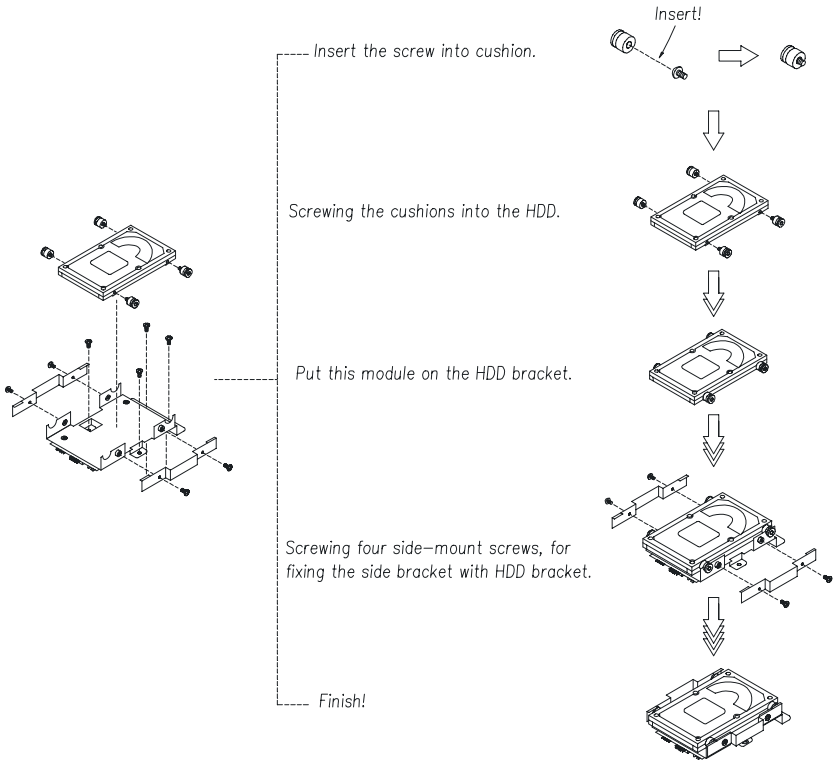

Figure 2-7: HDD Assembly

the accessory box to screw the rubber onto the hard disk. The finished hard disk assembly is shown in Figure 2-8.



*Figure 2-8: Rubber screwed onto the hard disk*

2. Turn off the PPC-103 and remove the rear cover.
3. Connect the HDD flat cable (44-pin to 44-pin) from the hard disk to the PC board, as shown in Figure 2-9. Make sure that the red wire corresponds to pin 1 on the connector, which is labeled on the board. Plug the other end of the cable into the enhanced IDE hard disk, with pin 1 on the cable corresponding to pin 1 on the hard disk. The HDD flat

cable should be folded as in Figure 2-6 to facilitate the installation.



*Figure 2-9: Connect flat cable to the HDD*

**Warning!** Plug the other end of the HDD cable into the HDD, with pin 1 on the cabel corresponding to pin 1 on the hard drive. Improper connection will damage the HDD.

4. Place the hard disk on the top of the hard disk base. The four rubber screws should fit into the side holes as shown in Figure 2-10.
5. Put the two HDD brackets comes in the accessory box on both sides of the hard disk as shown in Fig 2-10.
6. Secure the HDD brackets in position using the four screws in the accessory box.

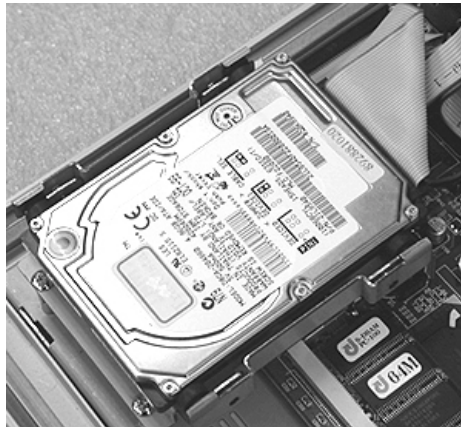

Figure 2-10: Assemble HDD brackets

### 2.3.3 Installing the SDRAM Memory Module

You can install from 16 MB to 256 MB of SDRAM memory. The PCM-9573 provides two 144-pin SODIMM (Dynamic Inline Memory Module) sockets.

**Note:**

The module can only fit into a socket one way. Pin 1 of the

SODIMM module must line up with the small arrowhead printed on the PCM-9573 next to the SODIMM socket. The golden pins of the module must point down into the SODIMM socket.

1. Ensure that all power sources are disconnected.
2. Slip the memory module into the socket at a 45 degree angle.
3. Push the module toward the Horizontal posts at both ends of the socket until the module is upright and the retaining clips at both ends of the module click into place. When positioned correctly, the pins on top of the vertical posts should correspond to the circular holes on the ends of the module.
4. Repeat steps 2 and 3 for each module you install.

### **2.3.4 Installing an FDD**

Up to two floppy drives can be attached to the PPC-103's I/O controller. Any combination of 5¼" (360 KB and 1.2 MB) and/or 3½" (720 KB, 1.44 MB, and 2.88 MB) drives can be attached.

A 34-pin FDD connector is located on the rear panel of the PPC-103. Unscrew the two attachment screws and detach the metal cover. Connect one end of a 34-pin daisy-chain drive connector cable and one end of a power signal cable (one each of these is included in the accessory box) to the FDD connector on the rear panel, and connect each of the other ends to an FDD.

Notes!

(1) Installation of two FDDs requires a flat ribbon connector with two plugs and a y-splitter for the power cable. The flat ribbon cable in the accessory kit has the required plugs. Users will have to procure an appropriate y-splitter for the power cable themselves.

(2) We recommend that only one FDD be installed on your PPC-103. The requisite power connector cable is included in the PPC-103 accessory box.

## **2.4 Installing I/O Equipment**

### **2.4.1 Installing one secondary HDD/CD-ROM device (external)**

Two connectors are located on the rear panel above the PPC-103's I/O output connectors. The 40-pin connector is for an external set of master and slave hard disks/CD-ROM. Connect the single end of the appropriate cable to the PPC-103, and connect the two remaining ends to your hard disk(s)/CD-ROM.

*Warning! All warnings in Section 2.3.1 apply here.*

Notes: (1) The 40-pin connector is a secondary channel.

(2) That part of the secondary IDE's cable which is below 45 cm in length is incorporated in the accessory box.

*Warning! Make sure that the red wire corresponds to pin 1 on the connectors.*

### **2.4.3 Parallel port connection**

Normally a parallel port is used to connect a printer to a system. The PPC-103 includes one multimode (ECP/EPP/SPP) parallel port with a 25-pin D-sub connector.

The parallel port is designated as LPT1 and can be disabled.

The parallel port interrupt channel is designated to be IRQ7 or IRQ5. The BIOS standard setup menu allows selection of "378H/IRQ7".

ECP/EPP DMA channels (DMA1 and DMA3) can be selected via the BIOS setup.

### **2.4.4 PS/2 keyboard and PS/2 mouse**

The PPC-103 provides a PS/2 keyboard connector that supports a PS/2 style keyboard and a 5-pin DIN keyboard extension cable. In most cases, especially in embedded applications, a keyboard is not used. The standard PC/AT BIOS will report an error or failure during power-on self-test (POST) after a reset if the keyboard is not present. The BIOS standard setup menu allows you to select\* "All , But Keyboard" under the "Halt On" selection. This allows no-keyboard operation in embedded system applications without the system halting under POST. Note that the mouse port on the PPC-103 is a PS/2 mouse port.

\* Note: "All, But keyboard" is the default setting.

### **2.4.5 Mic-in, line-out**

The PPC-103 contains an ESS 1938 chipset, which is a single, mixed-signal audio chip designed into the PPC-103. It provides high-quality stereo sound and FM music synthesis, and is compatible with Sound Blaster Pro version 3.01 voice and music functions. The PPC-103 includes Mic-in and Line-out and capabilities as part of its I/O adapter capabilities. These capabilities are provided under the Plug and Play (PnP) standard, which allows PnP configuration for your equipment.

To use the PPC-103's audio function:

1. Turn off the PPC-103.
2. Use speaker cables included in the accessory box to connect the speakers to the Line-out port.
3. Plug in the microphone's cable to the Mic-in port.
4. Connect the Line-in cable (included in the PPC-103 accessory box) between the Lin-in port and a CD-ROM or other audio source.
5. When installing a CD-ROM, please refer to Section 2.4.1 "Installing one secondary HDD/CD-ROM device (external)".

## 2.4.6 External VGA

The PPC-103 can be connected to an external CRT monitor. To connect an external CRT monitor, connect the monitor's VGA cable to the PPC-103's VGA port and connect the monitor's power cable to an AC outlet. The PPC-103's external CRT display (VGA) connector is a standard 15-pin D-SUB connector commonly used for VGA.

## 2.4.7 Four serial COM ports

Many available peripherals, such as a serial mouse or an optional touchscreen, require connection to a serial COM port. **When an optional touchscreen is ordered with a PPC-103, it shares COM4, and COM4 is not available as a serial port.**

## 2.4.8 Ethernet

The PPC-103 is equipped with a high performance 32-bit Ethernet chipset which is fully compliant with the IEEE 802.3 100 Mbps CSMA/CD standards. It is supported by major network operating systems. It is also both 100Base-T and 10Base-T compatible. The medium type can be configured via the RSET8139.EXE program included on the utility disk. (See Chapter 4 "Software Configuration" for detailed information.)

The Ethernet port provides a standard RJ-45 jack. The network boot feature can be utilized by incorporating the boot ROM image files for the appropriate network operating system. The boot ROM BIOS files are combined with system BIOS, which can be enabled/disabled in the BIOS setup.

## **2.5 Installing Software to the HDD**

Installing software requires an installed HDD. Software can be loaded in the PPC-103 using any of four methods:

### **2.5.1 Method 1: Use the Ethernet**

You can use the Ethernet port to download software to the HDD.

### **2.5.2 Method 2: Use an FDD**

The FDD port is located on the rear panel. Unscrew the two screws and detach the metal plate. Attach a communication cable and a power cable to the FDD port, then attach them to an FDD. Insert a disk containing the software and consult your software manual for installation procedures.

### **2.5.3 Method 3: Use the COM or parallel port**

You can use Lap Link 6 or similar transmission software. Connect another PC to the PPC-103 with an appropriate cable and transmit the software to the PPC-103.

### **2.5.4 Method 4: Use a 3.5" HDD or CD-ROM**

Please refer to Section 2.4.1 "Installing one secondary HDD/CD-ROM device (external)".

## 2.6 Exploded Diagram

Figure 2-11 shows all the components and parts that make up the PPC-103. Use it as a guide when assembling and disassembling your system.

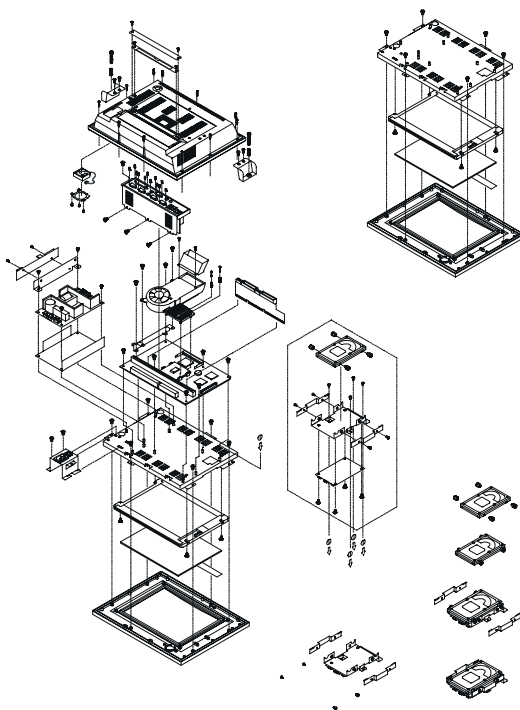
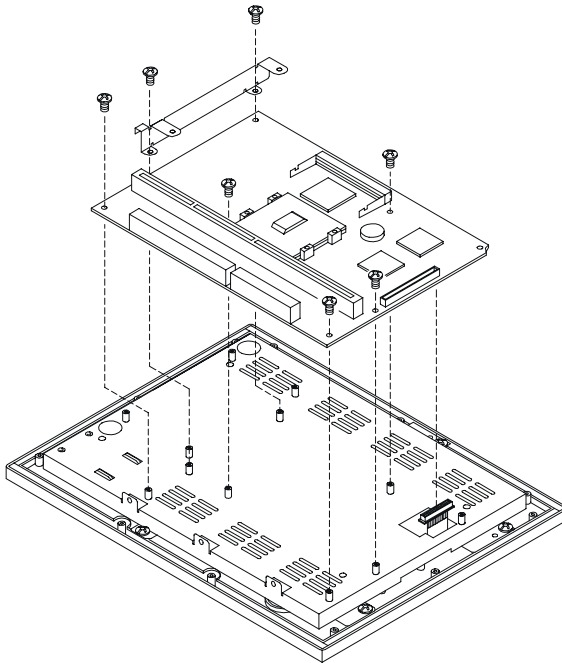

*Figure 2-11: PPC-103 exploded diagram*

## 2.7 PCM-9573 and I/O Adapter Replacement

To replace or service the PCM-9573 (the all-in-one CPU board) and I/O adapter, complete the following steps:

1. Power off the PPC-103.
2. Remove the rear protective cover.
3. Install the PCM-9573 in the panel and screw in the four screws (see Figure 2-12).
4. When the PCM-9573 is mounted in the panel, plug and press the adapter into the socket (see Figure 2-13).
5. Some screws on your left hand side connect the I/O adapter to the PC, and also connect the adapter to the PCM-9573. Screw the screws into the panel.



*Figure 2-12: Installing/removing the PCM-9573 in the PPC-103*

You may change the jumper settings for RS-232/422/485 before installing the I/O adapter.

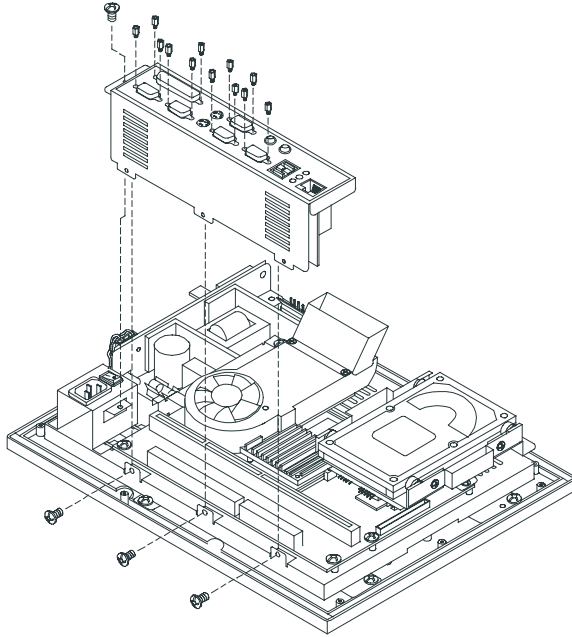

*Figure 2-13: Installing/removing the I/O adapter in the PPC-103*

## 2.8 Power Supply and Cooling Fan Replacement

To service or replace the power supply and/or the cooling fan, the back cover must first be removed.

**Warning:** *Power cables must be detached before you attempt to repair the power supply.*



1. Disconnect the power cables and remove the four screws to detach the power supply from the panel PC (Figure 2-14).
2. Refer to Appendix B for detailed power supply specifications. Ensure that any replacement power supply matches the system's specifications.
3. The cooling fan is located inside the rear panel. You can remove the cooling fan by first removing the four screws (Figure 2-15).

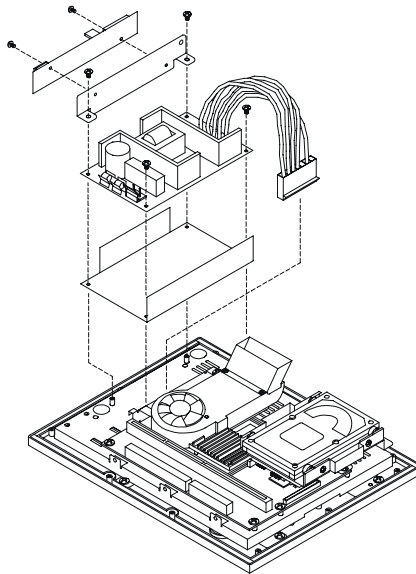

*Figure 2-14: Replacing the power supply*

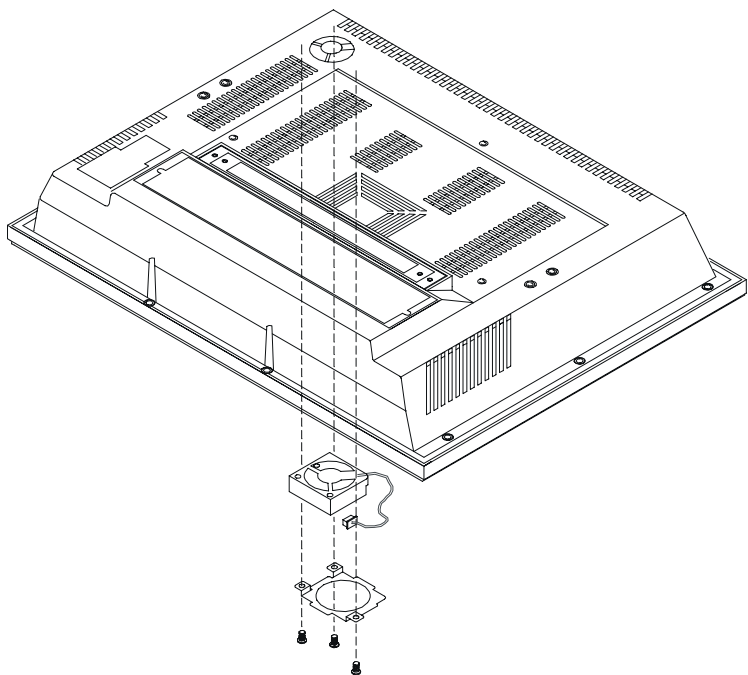

*Figure 2-15: Replacing the cooling fan*



# CHAPTER 3

## **Jumper Settings and Connectors**

This chapter tells how to set up the panel PC hardware, including instructions on setting jumpers and connecting peripherals, switches and indicators. Be sure to read all the safety precautions before you begin the installation procedures.

- Jumpers and Connectors
- CMOS Clear for External RTC (JP7)
- COM-port Interface
- VGA Interface
- Watchdog Timer Configuration

## 3.1 Jumpers and Connectors

---

### 3.1.1 Setting jumpers

You can configure your panel PC to match the needs of your application by setting jumpers. A jumper is the simplest kind of electrical switch. It consists of two metal pins and a small metal clip (often protected by a plastic cover) that slides over the pins to connect them. To “close” a jumper, you connect the pins with the clip. To “open” a jumper you remove the clip. Sometimes a jumper will have three pins, labeled 1, 2, and 3. In this case, you would connect either pins 1 and 2 or pins 2 and 3.

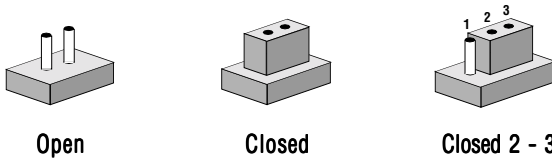

The jumper settings are schematically depicted in this manual as follows:

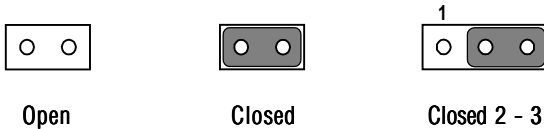

A pair of needle-nose pliers may be helpful when working with jumpers.

If you have any doubts about the best hardware configuration for your application, contact your local distributor or sales representative before you make any changes.

### 3.1.2 Jumpers and switch

The motherboard of the PPC-103 has a number of jumpers that allow you to configure your system to suit your applications. The table below lists the function of each of the board's jumpers.

Table 3-1: Jumpers and their functions

<b>Label</b>	<b>Function</b>
JP2	COM2 RS-232/422/485 setting
JP3	COM2 RS-232/422/485 setting
JP4	COM2 RS-232/422/485 setting
JP5	COM3 / COM4 Pin 9 output type setting
JP6	Watchdog timer configuration
JP7	CMOS clear for external RTC

### 3.1.3 Locating jumpers and switch

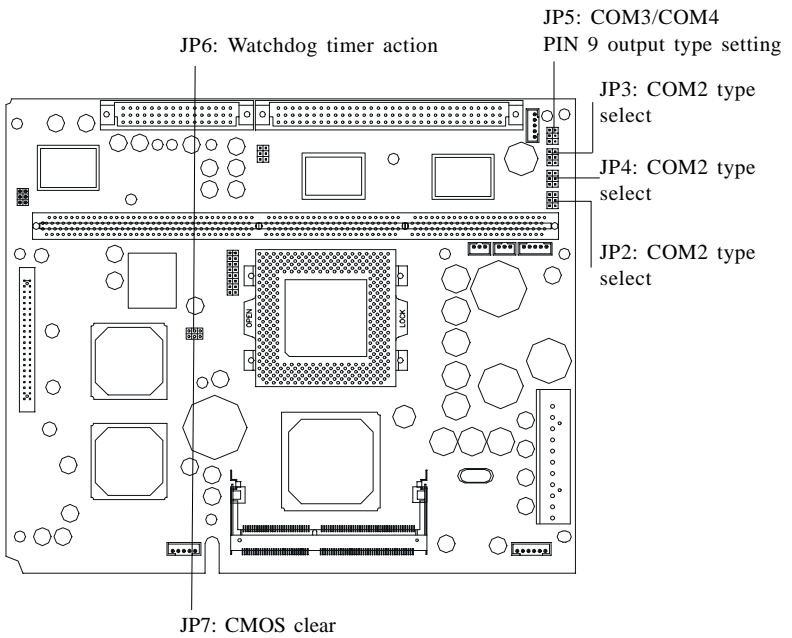

**Figure 3-1: Jumpers on the PPC-103 motherboard**

### 3.1.4 Connectors

Onboard connectors link the PPC-103 to external devices such as external hard disk drives or floppy drives. The table below lists the function of each of the board's connectors.

Table 3-2: Connectors on the PPC-103 motherboard

<b>Label</b>	<b>Function</b>
J1	AT power connector
J2	TV connector
J3	Inverter power connector
J4	Speaker connector
J5	Front panel display connector
J6	Touch screen control connector
J7	SIR connector
FAN1	CPU fan power connector
FAN2	System fan power connector
DIMM2	for 144P SO-DIMM (3.3V SDRAM)
SL1	AGP expansion connector

### 3.1.5 Locating connectors

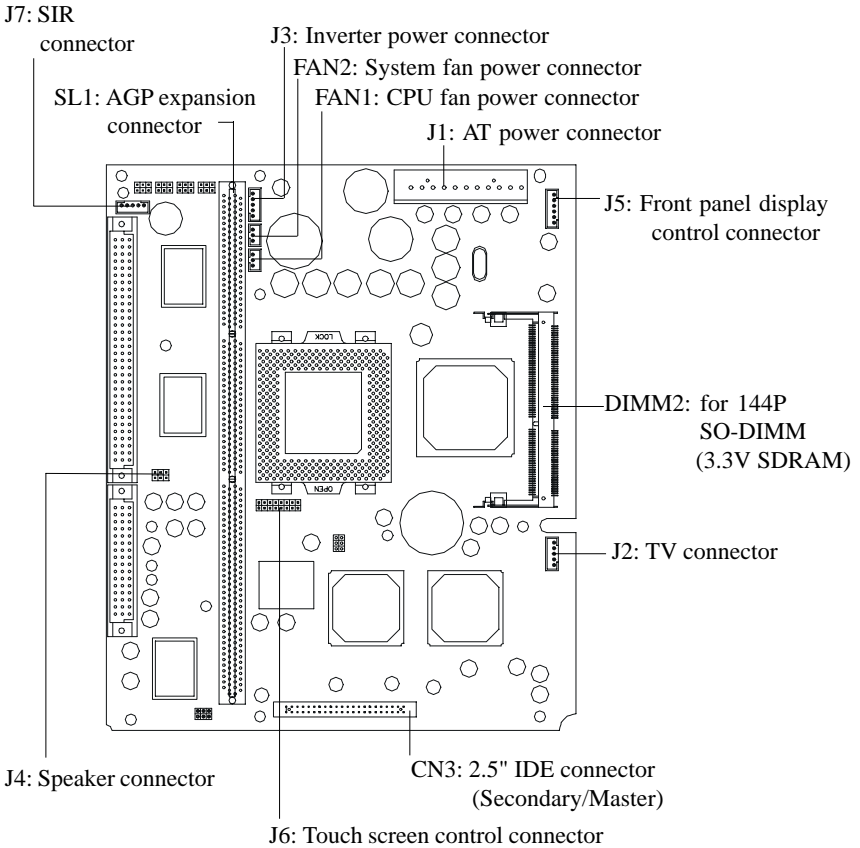
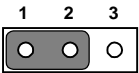
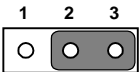

**Figure 5-2: Locating connectors on the PPC-103 motherboard**

### 3.3 CMOS Clear for External RTC (JP7)

**Warning:** To avoid damaging the computer, always turn off the power supply before setting “Clear CMOS”. Set the jumper back to “Normal operation” before turning on the power supply.

Table 3-3: Clear CMOS / External RTC (JP7)

*Normal operation	Clear CMOS
	

\* default setting









### 3.4 COM-port Interface

The panel PC provides four serial ports (COM1, 3, 4: RS-232; COM2: RS-232/422/485) in one COM port connector.

#### 3.4.1 COM2 RS-232/422/485 setting (JP2, JP3, JP4)

COM2 can be configured to operate in RS-232, RS-422, or RS-485 mode. This is done via JP3, JP4 and JP5.

Table 3-4: COM2 RS-232/422/485 setting (JP2, JP3)

*RS-232		RS-422/485					
JP2	2		6	JP2	2		6
	1		5		1		5
JP3	2		6	JP3	2		6
	1		5		1		5

\* default setting

Table 3-5: COM2 RS-232/422/485 setting (JP4)

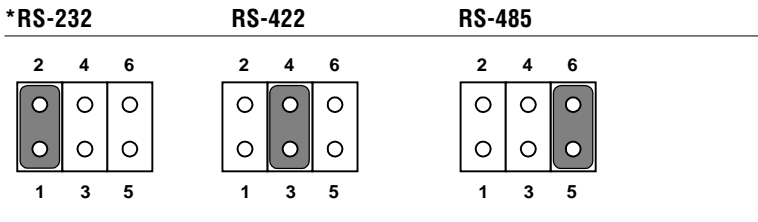

\* default setting

The IRQ and the address ranges for COM1, 2, 3, and 4 are fixed. However, if you wish to disable the port or change these parameters later you can do this in the system BIOS setup. The table overleaf shows the default settings for the panel PC's serial ports.

COM1 and COM2 are one set. You can exchange the address range and interrupt IRQ of COM1 for the address range and interrupt IRQ of COM2. After exchanging, COM2's address range is 3F8 ~ 3FF and its request IRQ is IRQ4; and COM1's address range is 2F8 ~ 2FF and its interrupt IRQ is IRQ3.

COM3 and COM4 are another set. Their selectable function is the same as the COM1/COM2 set.

Table 3-6: Serial port default settings

Port	Address Range	Interrupt
COM1	2F8 ~ 2FF	IRQ3
COM2	3F8 ~ 3FF	IRQ4
COM3	3E8 ~ 3EF	IRQ10
COM4	2E8 ~ 2EF	IRQ5

### 3.4.2 COM3 / COM4 pin 9 output type setting (JP5)

Table 3-8: COM3/COM4 pin 9 setting (JP5)

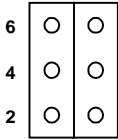
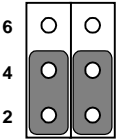
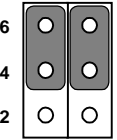
*Normal operation	+5 V output	+12 V output
		

\* default setting

*Note:* Pins 1, 3 and 5 are for COM3.  
Pins 2, 4 and 6 are for COM4.

## 3.5 VGA Interface

The panel PC's AGP VGA interface can drive conventional CRT displays. It is also capable of driving a wide range of flat panel displays, including electroluminescent (EL), gas plasma, passive LCD and active LCD displays. The board has two connectors to support these displays simultaneously: one for standard CRT VGA monitors, and one for flat panel displays.

### 3.5.1 LCD panel power setting

The panel PC's AGP SVGA interface supports 5 V and 3.3 V LCD displays. The LCD cable already has a built-in default setting. You do not need to adjust any jumper or switch to select the panel power.

# 3.6 Watchdog Timer Configuration

An onboard watchdog timer reduces the chance of disruptions which EMP (electromagnetic pulse) interference can cause. This is an invaluable protective device for standalone or unmanned applications. Setup involves one jumper and running the control software. (Refer to Appendix B.)

## 3.6.1 Watchdog activity selection (JP6)

When the watchdog timer activates (i.e. CPU processing has come to a halt), it can reset the system or generate an interrupt on IRQ11. This can be set via jumper JP6 as shown below:

Table 3-11: Watchdog activity selection (JP6)

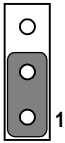
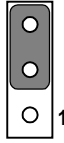
*System reset	IRQ11
	

\* default setting

# CHAPTER 4

## **Award BIOS Setup**

This chapter describes how to set BIOS configuration data.

## 4.1 Award BIOS Setup

The PPC-103 comes with an Award BIOS chip that contains the ROM setup for your system. This chip serves as an interface between the processor and the rest of the mainboard's components. This chapter explains the information contained in the setup program and tells you how to modify the settings according to your system configuration. Some setup items will not be explained, because it is recommended that users do not change such items.

*Note: Values for the various setup items that appear on your own screen (including default values) may not be the same as the values shown on the screen figures in this chapter. This is because the BIOS is revised and updated from time to time. If in doubt, check Advantech's website for the latest BIOS versions and related information.*

## 4.2 CMOS Setup Utility

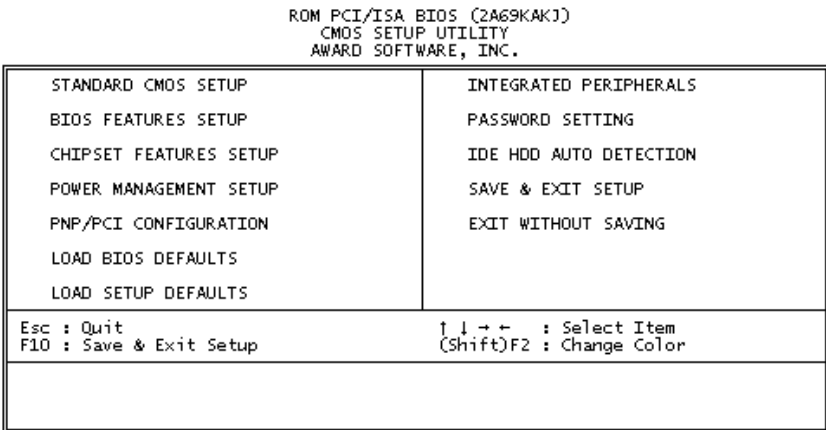

Figure 4-1: Setup program initial screen

A setup program, built into the system BIOS, is stored in the CMOS RAM that allows the configuration settings to be changed. This

program is executed when the user changes the system configuration; when the user changes the system backup battery; or when the system detects a configuration error and asks the user to run the setup program. At power-on RAM testing, the message "Press DEL to enter Setup" appears. After pressing the "DEL" key, the CMOS setup utility screen will appear as shown in Fig. 4-1. Use the arrow keys to select and press "Enter" to run the selected program.

### 4.3 Standard CMOS Setup

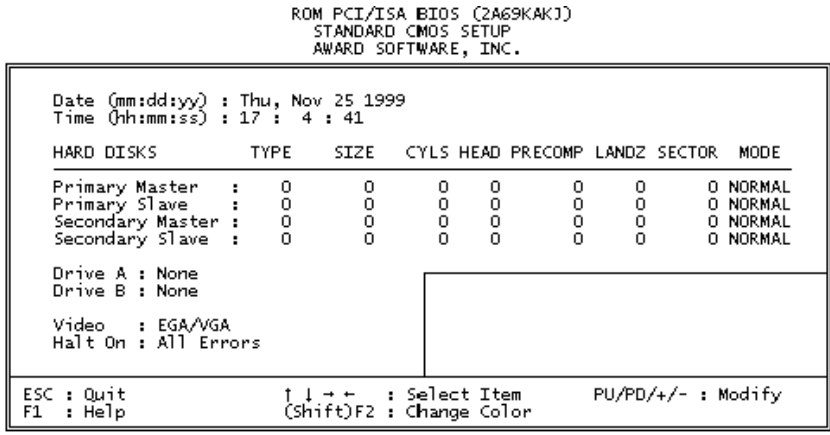

Figure 4-2: CMOS setup screen

The standard CMOS setup screen is shown above. System BIOS automatically detects memory size, so no changes are necessary. It has a few items requiring setting. Each item may have one or more optional settings. System BIOS allows you to change the system date and time, IDE hard disk, floppy disk drive types for drives A: and B:, boot-up video display mode, and POST error handling selection. Use the arrow keys to highlight the item and then use the "PgUp" or "PgDn" keys to select the value you want for each item.

#### 4.3.1 Hard disk configurations

##### TYPE

Select from 1 to 45 to fill the remaining fields with predefined values

for disk drives. Select "User" to fill the remaining fields. Select "Auto" to detect the HDD type automatically.

**SIZE**

Hard disk size. The unit is megabytes (MB).

**CYLS**

The cylinder number of the hard disk.

**HEAD**

The read/write head number of the hard disk.

**PRECOMP**

The cylinder number at which the disk drive changes the write timing.

**LANDZ**

The cylinder number where the disk drive heads (read/write) are seated when the disk drive is parked.

**SECTOR**

The sector number of each track defined on the hard disk.

**MODE**

Select "Auto" to detect the mode type automatically. If your hard disk supports the LBA mode, select "LBA" or "Large". However, if your hard disk supporting cylinder is more than 1024 MB and does not support the LBA function, you have to select "Large". If your hard disk supporting cylinder is below 1024 MB, select "Normal".

## 4.4 BIOS Features Setup

ROM PCI/ISA BIOS (2A69KAKJ)  
BIOS FEATURES SETUP  
AWARD SOFTWARE, INC.

Virus Warning	: Disabled	Video BIOS Shadow	: Enabled
CPU Internal Cache	: Enabled	C8000-CBFFF Shadow	: Disabled
External Cache	: Enabled	CC000-CFFFF Shadow	: Disabled
CPU L2 Cache ECC Checking	: Enabled	D0000-D3FFF Shadow	: Disabled
Processor Number Feature	: Enabled	D4000-D7FFF Shadow	: Disabled
Quick Power On Self Test	: Enabled	D8000-DBFFF Shadow	: Disabled
Boot From LAN First	: Disabled	DC000-DFFFF Shadow	: Disabled
Boot Sequence	: C, A, SCSI		
Swap Floppy Drive	: Disabled		
Boot Up Floppy Seek	: Enabled		
Boot Up NumLock Status	: On		
Gate A20 Option	: Fast		
Typeomatic Rate Setting	: Disabled		
Typeomatic Rate (Chars/Sec)	: 6		
Typeomatic Delay (Msec)	: 250		
Security Option	: Setup	ESC : Quit	↑↓←→ : Select Item
PS/2 mouse function control	: Enabled	F1 : Help	PU/PD/+/- : Modify
PCI/VGA Palette Snoop	: Disabled	F5 : Old Values (Shift)	F2 : Color
OS Select For DRAM > 64MB	: Non-OS2	F6 : Load BIOS Defaults	
Report No FDD For WIN 95	: Yes	F7 : Load Setup Defaults	

Figure 4-3: BIOS features setup screen

Moving around the BIOS Features and Chipset Features setup programs works the same way as moving around the Standard CMOS setup program. (Refer to the next section for Chipset Features setup.) The BIOS Features setup program is shown above. Users are not encouraged to run the BIOS and Chipset Features setup programs. Your system should have been fine-tuned before shipping. Improper setup may cause the system to fail, so consult your dealer before making any changes.

### Virus Warning

When enabled, it assigns the BIOS to monitor the master boot sector and the DOS sector of the first hard disk drive.

The options are: Disabled (Default), Enabled.

### CPU Internal Cache

When enabled, it improves system performance. Disable this item when testing or troubleshooting.

The options are: Enabled (Default), Disabled.

**External Cache**

When enabled, supports an external cache SRAM.

The options are: Enabled (Default), Disabled.

**CPU L2 Cache ECC Checking**

Allows the CPU L2 cache to enable the memory parity check.

The options are: Disabled (Default), Enabled.

**Quick Power On Self Test**

When enabled, allows the BIOS to bypass the extensive memory test.

The options are: Disabled (Default), Enabled.

**Boot From LAN First**

Enables the system to boot from a LAN.

The options are: Disabled (Default), Enabled.

**Boot Sequence**

Allows the system BIOS to first try to boot the operating system from the selected disk drive.

The options are:

C, A, SCSI (Default)

LS/ZIP, C

C (only)

SCSI, C, A

SCSI, A, C

F, A, SCSI

E, A, SCSI

D, A, SCSI

CDROM, C, A

C, CDROM, A

### **Swap Floppy Drive**

When enabled, allows you to switch the order in which the operating system accesses the floppy drives during boot-up.

The options are: Disabled (Default), Enabled.

### **Boot Up Floppy Seek**

When enabled, assigns the BIOS to perform floppy disk drive tests by issuing seek commands. Note that such tests are time-consuming.

The options are: Enabled (Default), Disabled.

### **Boot Up NumLock Status**

When set to "On", allows the BIOS to automatically enable the NumLock function when the system boots up.

The options are: On (Default), Off.

### **Typematic Rate Setting**

The term typematic means that when a keyboard key is held down, the character is repeatedly entered until the key is released. When this item is enabled, you may change the typematic repeat rate.

The options are: Disabled (Default), Enabled.

### **Typematic Rate (Chars/Sec)**

Sets the rate of a character repeat when the key is held down.

The options are: 6 (Default), 8, 10, 12, 15, 20, 24, 30.

### **Typematic Delay (msec)**

Sets the delay time before a character is repeated.

The options are: 250 (Default), 500, 750, 1000 milliseconds.

### **Security Option**

Allows you to set the security level of the system.

The options are: Setup (Default), System.

### **PS/2 Mouse Function Control**

When enabled, the PS/2 mouse is activated.

The options are: Disabled (Default), Enabled.

### **PCI/VGA Palette Snoop**

When enabled, allows you to install an enhanced graphics adapter card. If your graphics adapter card does not support the Palette Snoop function, set at "Disabled" to avoid system malfunctions.

The options are: Disabled (Default), Enabled.

### **OS Select For DRAM > 64MB**

If your operating system (OS) is OS2, select "OS2". Otherwise, stay with the default setting Non-OS2.

### **Report No FDD For WIN 95**

Assigns IRQ6 for the FDD.

The options are: Yes (Default), No.

### **Video BIOS Shadow**

When enabled, allows the BIOS to copy the video ROM code of the add-on video card to the system memory, giving faster access.

The options are: Enabled (Default), Disabled.

### **C8000-CBFFF Shadow through to DC000-DFFFF Shadow**

When enabled, allows the BIOS to copy the BIOS ROM code of the add-on card to the system memory for faster access. It may improve the performance of the add-on card. Some add-on cards will not function properly if their BIOS ROM codes are shadowed. To use this option correctly, you need to know the memory address range used by the BIOS ROM of each add-on card.

The options are: Disabled (Default), Enabled.

## **4.5 Chipset Features Setup**

*Note: It is strongly recommended that setup items in this section NOT be changed, because advanced*

*knowledge is required to effect such changes.*

ROM PCI/ISA BIOS (2A69KAKJ)  
CHIPSET FEATURES SETUP  
AWARD SOFTWARE, INC.

Auto Configuration	: Enabled	Power-Supply Type	: AT
EDO DRAM Speed Selection	: 60ns	Auto Detect DIMM/PCI Clk	: Enabled
EDO CASx# MA Wait State	: 2	Spread Spectrum	: Disabled
EDO RASx# Wait State	: 1	CPU Host Clock (CPU/PCI)	: Default
SDRAM RAS-to-CAS Delay	: 3	CPU Warning Temperature	: Disabled
SDRAM RAS Precharge Time	: 3	Current System Temp.	:
SDRAM CAS latency Time	: Auto	Current CPU Temperature	:
SDRAM Precharge Control	: Disabled	Current System Fan Speed	:
DRAM Data Integrity Mode	: Non-ECC	Current CPU Fan Speed	:
System BIOS Cacheable	: Enabled	Vcore	: +3.3V
Video BIOS Cacheable	: Enabled	+ 5 V	: +12 V
Video RAM Cacheable	: Enabled	-12 V	:-
8 Bit I/O Recovery Time	: 1		
16 Bit I/O Recovery Time	: 1		
Memory Hole At 15M-16M	: Disabled		
Passive Release	: Enabled	ESC : Quit	↑↓←→ : Select Item
Delayed Transaction	: Disabled	F1 : Help	PU/PD/+/- : Modify
AGP Aperture Size (MB)	: 64	F5 : Old Values	(Shift)F2 : Color
		F6 : Load BIOS Defaults	
		F7 : Load Setup Defaults	

*Figure 4-4: Chipset features setup screen*

### **EDO CASX# MA Wait State**

Sets the EDO CASX# MA wait state.

The options are: 1 (Default), 2.

### **EDO RASX# Wait State**

Sets the EDO RASX# wait state.

The options are: 1 (Default), 2.

### **SDRAM CAS Latency Time**

Sets the SDRAM CAS latency time.

The options are: Auto (Default), 2, 3.

### **SDRAM Data Integrity Mode**

When set as Non-ECC, supports standard 64-bit DIMM RAM modules. When set as ECC, supports standard 72-bit ECC RAM modules.

The options are: Non-ECC (Default), ECC.

### **System BIOS Cacheable**

When enabled, allows the ROM area F000H-FFFFH to be cacheable when the cache controller is activated. The recommended setting is "Disabled", especially for high speed CPUs (200 MHz and above).

### **Video BIOS Cacheable**

When enabled, allows the system to use the video BIOS codes from SRAMs, instead of the slower DRAMs or ROMs.

The options are: Enabled (Default), Disabled.

### **Video RAM Cacheable**

Enables video RAM to be cacheable.

The options are: Disabled (Default), Enabled.

### **16 Bit I/O Recovery Time**

Sets 16-bit I/O signal recovery time.

The options are: 1 (Default), 2, 3, 4, N/A.

### **Memory Hole at 15M-16M**

When enabled, the memory hole at the 15 MB address will be relocated to the 15 ~ 16 MB address range of the ISA cycle when the processor accesses the 15 ~ 16 MB address area.

The options are: Disabled (Default), Enabled.

### **Delayed Transaction**

When disabled, the system operates normally. When enabled, the system can support lower-speed ISA devices.

The options are: Disabled (Default), Enabled.

### **Spread Spectrum**

When disabled, the system operates normally. When enabled, the spread spectrum will be set to 0.5% (CNTR).

The options are: Disabled (Default), Enabled.

## 4.6 Power Management Setup

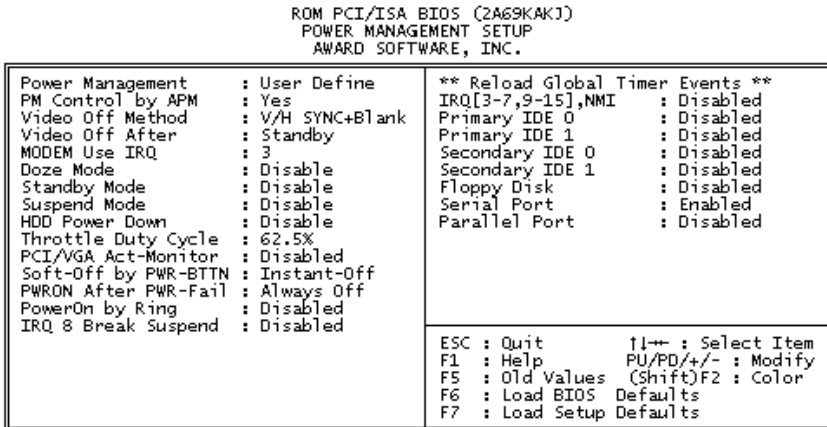

Figure 4-5: Power management setup screen

### Power Management

When enabled, allows you to use Power Management features.

The options are: Disabled (Default), Enabled.

### PM Control by APM

The option "No" allows the BIOS to ignore the APM (Advanced Power Management) specification. Selecting "Yes" will allow the BIOS to wait for APM's prompt before it enters Doze mode, Standby mode, or Suspend mode. If the APM is installed, it will prompt the BIOS to set the system into power saving mode after all tasks are done.

The options are: Yes (Default), No.

### Video Off Option

This feature provides the selections for the video display power saving mode. The option "Susp, Stby--Off" allows the video display to go

blank if the system enters Suspend or Standby mode. The option "Suspend--Off" allows the video display to go blank if the system enters Suspend mode. The option "All Modes--Off" allows the video display to go blank if the system enters Doze mode or Suspend mode. The option "Always On" allows the video display to stay in Standby mode even when the system enters Doze or Suspend mode.

The options are: Susp, Stby= Off (Default), Suspend =Off

All Mode+ Off, Always On.

### **Video Off Method**

"DPMS Supported" allows the BIOS to blank off the screen display with your VGA card which supports DPMS (Display Power Management Signaling function). "Blank Screen" allows the BIOS to blank the screen display by turning off the red-green-blue signals.

The options are: DPMS Supported (Default), Blank Screen.

### **MODEM Use IRQ**

This feature allows you to select the IRQ# to meet your modem's IRQ#.

The options are: 3 (Default), 4, 5, 7, 9, 10, 11, NA.

### **Doze Mode**

The system will not enter Doze mode, because this option is designated as "Disabled".

### **Standby Mode**

The system will not enter Standby mode, because this option is designated as "Disabled".

### **Suspend Mode**

The system will not enter Suspend mode, because this option is designated as "Disabled".

### **HDD POWER Down**

Selecting "Disabled" will turn off the hard disk drive (HDD) motor. Selecting "1 Min.. 15 Min" allows you to define the HDD idle time

before the HDD enters Power Saving Mode.

The options "1 Min.. 15 Min" and "When Suspend" will not work concurrently. When the HDD is in Power Saving Mode, any access to the HDD will wake it up.

The options are: Disabled (Default), 1 Min., 15 Min.

## 4.7 PNP/PCI Configuration Setup

```
ROM PCI/ISA BIOS (2A69KA<J>)
PNP/PCI CONFIGURATION
AWARD SOFTWARE, INC.

PNP OS Installed      : No
Resources Controlled By : Manual
Reset Configuration Data : Disabled

Used MEM base addr  : N/A
Assign IRQ For USB  : Disabled

IRQ-3 assigned to : PCI/ISA PnP
IRQ-4 assigned to : PCI/ISA PnP
IRQ-5 assigned to : PCI/ISA PnP
IRQ-7 assigned to : PCI/ISA PnP
IRQ-9 assigned to : PCI/ISA PnP
IRQ-10 assigned to : PCI/ISA PnP
IRQ-11 assigned to : PCI/ISA PnP
IRQ-12 assigned to : PCI/ISA PnP
IRQ-14 assigned to : PCI/ISA PnP
IRQ-15 assigned to : PCI/ISA PnP
CMA-0 assigned to : PCI/ISA PnP
CMA-1 assigned to : PCI/ISA PnP
CMA-3 assigned to : PCI/ISA PnP
CMA-5 assigned to : PCI/ISA PnP
CMA-6 assigned to : PCI/ISA PnP
CMA-7 assigned to : PCI/ISA PnP

ESC : Quit          ↑↓ ← → : Select Item
F1  : Help          PU/PD/+/- : Modify
F5  : Old values   (Shift)F2 : Color
F6  : Load BIOS Defaults
F7  : Load Setup Defaults
```

Figure 4-6: PNP/PCI configuration setup screen

### PNP OS Installed

Select Yes if the installed system supports the PnP function. Select No if the installed system does not support the PnP function.

The options are: No (Default), Yes.

### Resources Controlled By

If set at "Auto", the BIOS automatically arranges all system resources for you. If there are conflicts or you are not satisfied with the configu-

ration, simply set all the resources listed in the above figure by selecting "Manual".

The options are: Manual (Default), Auto.

The manual options assigned to IRQ-/DMA- are: Legacy ISA, PCI/ISA PnP.

### Reset Configuration Data

When enabled, this feature allows the system to clear the last BIOS configuration data and then reset the data with the default BIOS configuration data.

The options are: Disabled (Default), Enabled.

### Used MEM base addr

Choose and use the MEM base address.

The options are: N/A (Default), C800 ~ DC00.

### Assign IRQ for USB

Assigns an IRQ for the USB.

The options are: Disabled (Default), Enabled.

## 4.8 Load BIOS Defaults

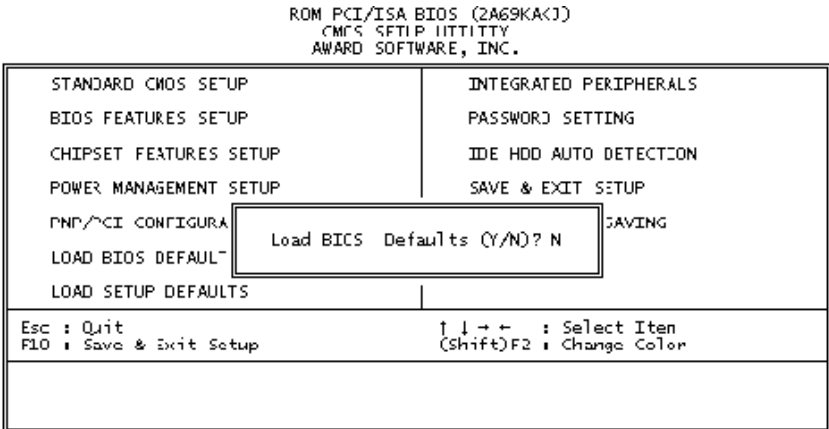

Figure 4-7: Load BIOS defaults screen

The BIOS defaults screen contains the most appropriate values of the system parameters that allow minimum system performance.

## 4.9 Load Setup Defaults

Selecting this field loads the factory defaults for BIOS and Chipset Features. The system will automatically detect these defaults.

## 4.10 Integrated Peripherals

ROM PCI/ISA BIOS (2A69KAKJ)  
 INTEGRATED PERIPHERALS  
 AWARD SOFTWARE, INC.

IDE HDD Block Mode	: Enabled	Onboard Serial Port 2 IRQ:	3
On-Chip Primary PCI IDE:	Enabled	UART Mode Select	:
On-Chip Secondary PCI IDE:	Enabled	UART2 Duplex Mode	: Half
IDE Primary Master PIO	: Auto	RxD , TxD Active	: Hi,Lo
IDE Primary Slave PIO	: Auto	IR Transmittion delay	: Enabled
IDE Secondary Master PIO	: Auto	Onboard Parallel Port	:
IDE Secondary Slave PIO	: Auto	Onboard Parallel Port IRQ:	7
IDE Primary Master UDMA	: Auto	Parallel Port Mode	:
IDE Primary Slave UDMA	: Auto	ECP Mode Use DMA	: 3
IDE Secondary Master UDMA	: Auto	EPP Mode Select	: EPP1.7
IDE Secondary Slave UDMA	: Auto	Onboard Serial Port 3	: 3E8H
Onboard PCI Lan Chip	: Enabled	Serial Port 3 Use IRQ	: IRQ10
USB Keyboard Support	: Disabled	Onboard Serial Port 4	: 2E8H
Init Display First	: PCI Slot	Serial Port 4 Use IRQ	: IRQ5
KBC input clock	: 8 Mhz		
Onboard FDC Controller	: Enabled		
Onboard Serial Port 1	:		
Onboard Serial Port 1 IRQ:	4		
Onboard Serial Port 2	:		

Figure 4-8: Integrated peripherals screen

### IDE HDD Block Mode

This allows your hard disk controller to use the fast block mode to transfer data to and from your hard disk drive (HDD).

The options are: Enabled (Default), Disabled.

### IDE Primary/Secondary Master/Slave PIO

IDE hard disk drive controllers can support up to separate hard drives.

These drives have a master/slave relationship which is determined by the cabling configuration used to attach them to the controller. Your system supports two IDE controllers - a primary and a secondary - so you have the ability to install up to four separate hard disks.

PIO means Programmed Input/Output. Rather than having the BIOS issue a series of commands to effect a transfer to or from the disk drive, PIO allows the BIOS to tell the controller what it wants and then let the controller and the CPU perform the task by themselves.

Your system supports five modes, numbered from 0 through 4, which differ primarily in timing. When "Auto" is selected, the BIOS will choose the best available mode.

The options are: Auto, (Default), Disabled.

### **Primary/Secondary Master/Slave Ultra DMA**

DMA means Direct Memory Access. Ultra DMA is faster than DMA. DMA is a method of transferring data to or from memory at a fast rate, without involving the CPU.

When you select "Auto", the BIOS will choose the best available mode.

The options are: Auto (Default), Disabled.

### **Onboard FDD Controller**

When enabled, the floppy disk drive (FDD) controller is activated.

The options are: Enabled (Default), Disabled.

### **Onboard Serial Ports 1 & 2**

If the serial ports use the onboard I/O controller, you can modify your serial port parameters.

The options for Port 1 are: 3F8/IRQ4 (Default), 2E8/IRQ3, Disabled, 2F8/IRQ3, 3E8/IRQ4.

The options for Port 2 are: 2F8/IRQ3 (Default), 3E8/IRQ4, 2E8/IRQ3, Disabled, 3F8/IRQ4.

### **Onboard Serial Ports 3 & 4**

If the serial ports use the onboard I/O controller, you can modify your serial port parameters.

The options for Port 3 are: 3E8/IRQ10 (Default), 2E8/IRQ5, Disabled.

The options for Port 4 are: 2E8/IRQ5 (Default), Disabled, 3E8/IRQ10.

### **Onboard Parallel Port**

If the parallel port uses the onboard I/O controller, you can modify your parallel port parameters. When you select "Disabled", the next two setup items will disappear.

The options are: 378/IRQ7 (Default), 3BC/IRQ7, 278/IRQ5, Disabled.

### **Parallel Port Mode**

You can choose different data transfer modes for your system.

The options are: ECP & EPP (Default), SPP, EPP, ECP.

### **ECP Mode Use DMA**

You can choose different DMA modes for data transfer.

The options are: 3 (Default), 1.

## **4.11 Password Setting**

To enable the password setting, select the item from the Standard CMOS Setup. You will be prompted to create your own password. Type your password up to eight characters and press "Enter". You will be asked to confirm the password. Type the password again and press "Enter". You may also press "Esc" to abort the selection and not enter a password. To disable the password, press "Enter" when you are prompted to enter the password. A message will appear, confirming the password is disabled.

Under the BIOS Features setup, if "System" is selected under the Security Option field and the Supervisor Password is enabled, you

will be prompted for the supervisor password every time you try to enter the CMOS Setup utility. If "System" is selected and User Password is enabled, you will be requested to enter the user password every time you reboot the system. If "Setup" is selected under the Security Option field and User Password is enabled, you will be prompted only when you reboot the system.

### 4.12 IDE HDD Auto Detection

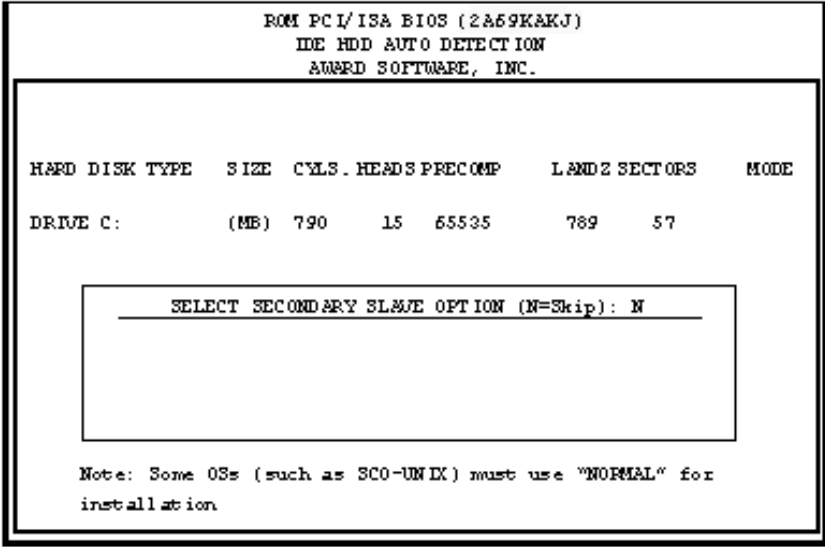

Figure 4-9: IDE HDD auto detection screen

The IDE Hard Disk Drive Auto Detection feature automatically configures your new hard disk. Use it for quick configuration of new hard disk drives. This feature allows you to set the parameters of up to four IDE HDDs. The option with "(Y)" is recommended by the system BIOS. You may also key in your own parameters instead of

setting them

according to the system BIOS. After keying in all settings, press "Esc" to return to the main menu. For confirmation, enter the Standard CMOS Setup feature.

### 4.13 Save and Exit Setup

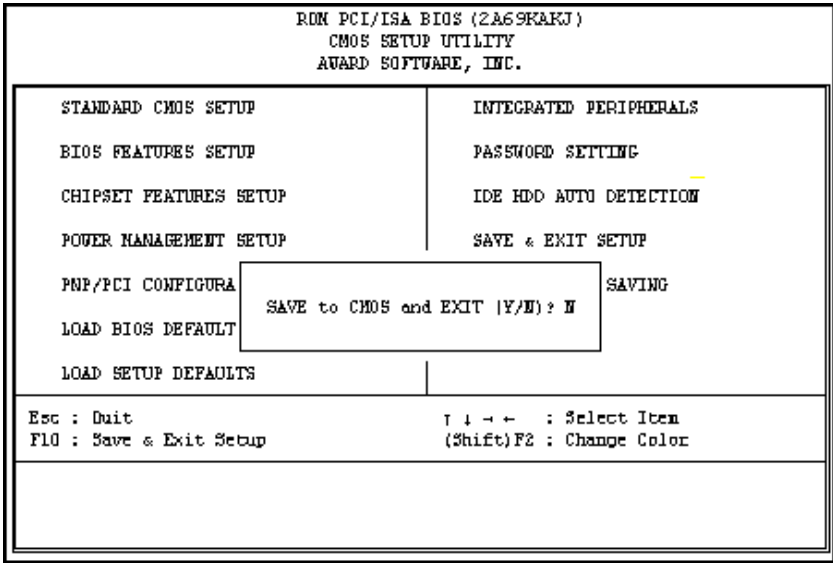

Figure 4-10: Save and exit setup screen

After you have made changes in the BIOS setup, press "Esc" to return to the main menu. Move the cursor to "Save and Exit Setup", or press "F10" and then press "Y", to change the CMOS Setup. If you did not change anything, press "Esc" again or move the cursor to "Exit Without Saving" and press "Y" to retain the setup settings. The following message will appear at the center of the screen to allow you to save data to CMOS and exit the setup utility:

SAVE to CMOS and EXIT (Y/N)?

### 4.14 Exit Without Saving

If you select this feature, the following message will appear at the center of the screen to allow you to exit the setup utility without

saving CMOS modifications:

Quit Without Saving (Y/N) ?

# CHAPTER 5

## PCI Bus Ethernet Interface

This chapter provides information on Ethernet configuration.

- Introduction
- Installation of Ethernet Driver
  - for Windows 95
  - for Windows 98
  - for Windows NT
- Further Information

## 5.1 Introduction

The PPC-103 is equipped with a high performance 32-bit Ethernet chipset which is fully compliant with IEEE 802.3 100 Mbps CSMA/CD standards. It is supported by major network operating systems. It is also both 100Base-T and 10Base-T compatible. The medium type can be configured via the RSET8139.exe program included on the utility disk.

The Ethernet port provides a standard RJ-45 jack. The network boot feature can be utilized by incorporating the boot ROM image files for the appropriate network operating system. The boot ROM BIOS files are combined with system BIOS, which can be enabled/disabled in the BIOS setup.

## 5.2 Installation of Ethernet Driver

Before installing the Ethernet driver, note the procedures below. You must know which operating system you are using in your PPC-103, and then refer to the corresponding installation flow chart. Then just follow the steps described in the flow chart. You will quickly and successfully complete the installation, even if you are not familiar with instructions for Windows.

*Important: The following windows illustrations are examples only. You must follow the flow chart instructions and pay attention to the instructions which then appear on your screen.*

*Note 1: The CD-ROM drive is designated as "D" throughout this chapter.*

*Note 2: <Enter> means pressing the "Enter" key on the keyboard.*

## 5.2.1 Installation for Windows 95

1. a. Select "Start," "Settings," "Control Panel," "System."  
b. Click "Device Manager" and "Other Devices."  
c. Remove "PCI Ethernet Controller."

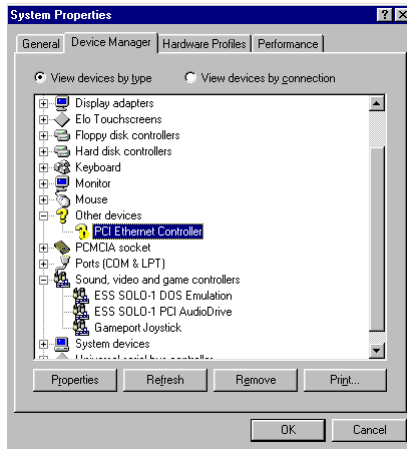

2. a. Select "Start," "Settings," "Control Panel," and "Network" icons.  
b. Click the "Add" button.

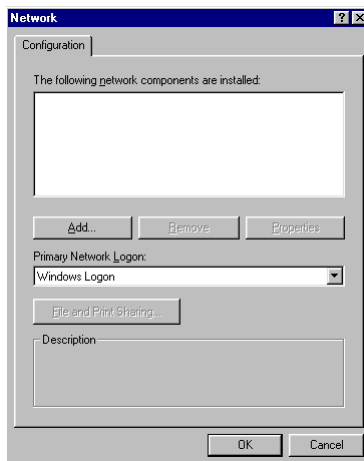

3. Select "Adapter" and then click the "Add" button.

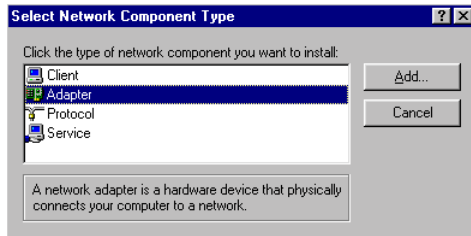

4. Press the "Have Disk..." button.

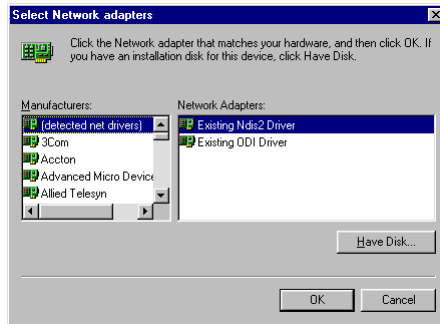

5. a. Type the path "D:\PPC103\LAN\W95OSR2"  
b. Click the "OK" button.

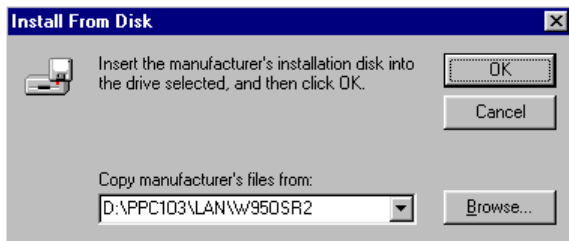

6. a. Choose the highlighted “realteck RTL8139[A/B/C/8130]PCI Fast Ethernet”
- b. Press the “OK” button

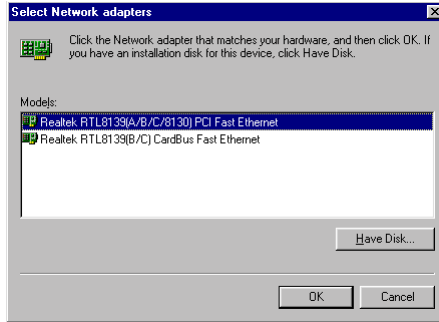

7. a. Press the “Add...”button to select suitable services or protocol.
- b. Press the “OK” button to finish network configuration.

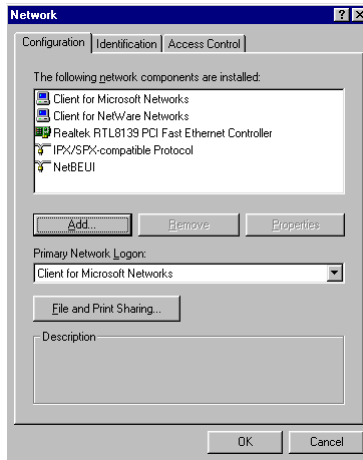

8. Press the “Yes” button to restart your computer.

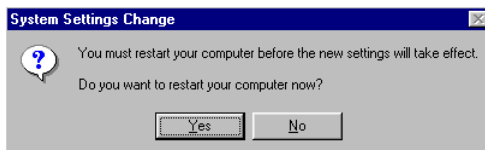

## 5.2.2 Installation for Windows 98

1. a. Select "Start," "Settings," "Control Panel," "System."  
b. Click "Device Manager" and "Other Devices."  
c. Remove "PCI Ethernet Controller."

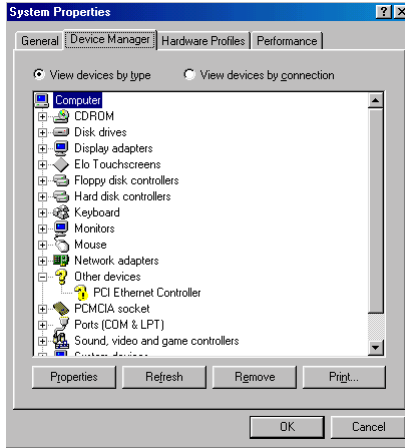

- 2 a. Select "Start," "Settings," "Control Panel," and "Network" icons.  
b. Click the "Add" button.

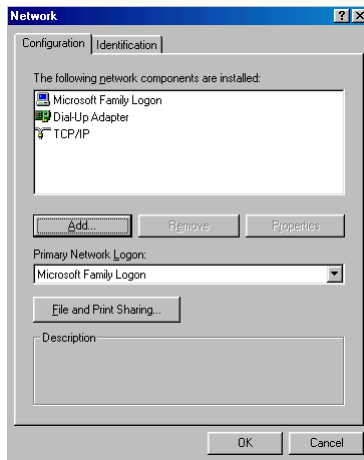

3 Select "Adapter" and then click the "Add" button.

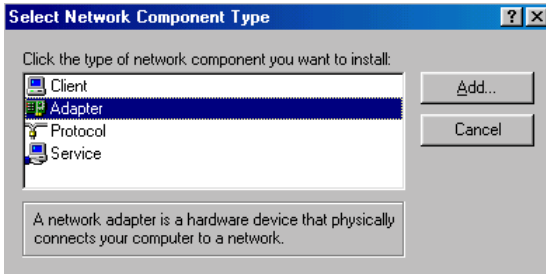

4. Press the "Have Disk" button.

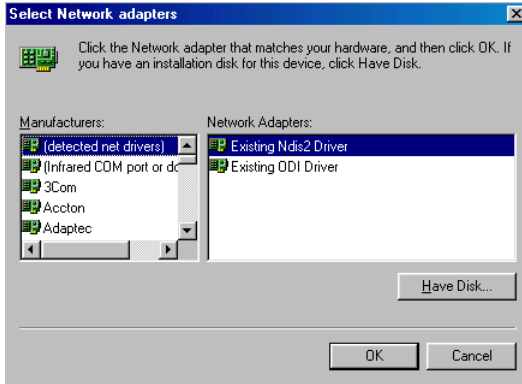

5. a. Type the path "D:\PPC103\LAN\WIN98."  
b. Click the "OK" button.

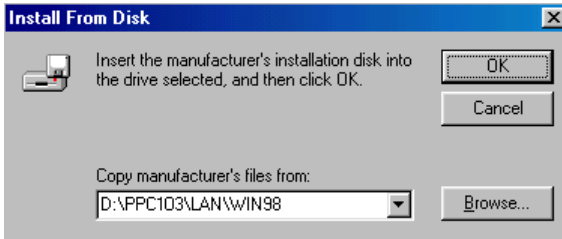

6. a. Choose the highlighted “Realtek RTL8139[A/B/C/8130]PCI Fast Ethernet NIC.”
- b. Press the “OK” button.

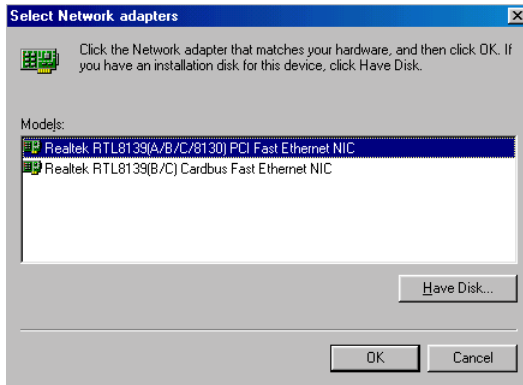

7. a. Press the “Add...” button to select suitable services or protocol.
- b. Press the “OK” button to finish network configuration.

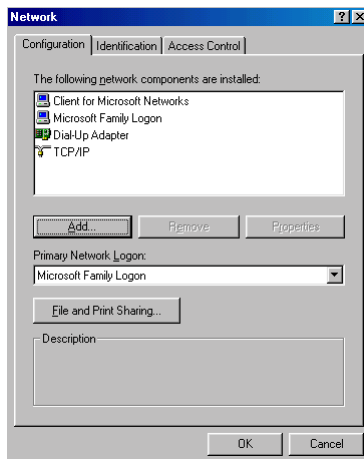

8. Press the “Yes” button to restart your computer.

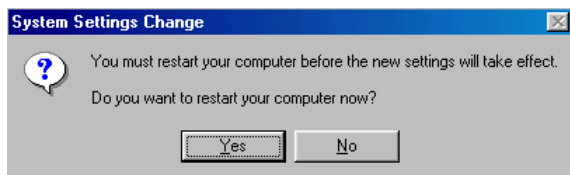

### 5.2.3 Installation for Windows NT

1. a. Select “Start,” “Settings,” “Control,” and then double click the “Network” icon.  
b. Choose the “Adapters” label.  
c. Click the “Add” button.

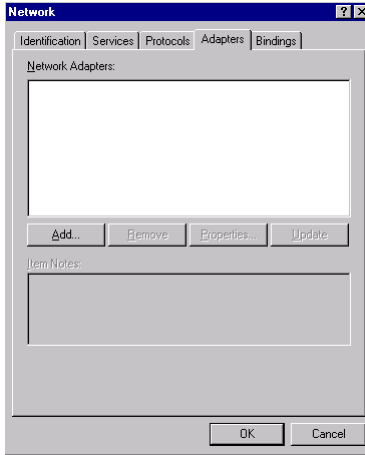

2. Press “Have Disk.”

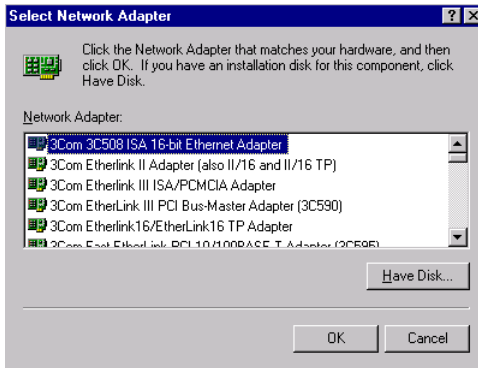

3. a. Type the path “D:\PPC103\LAN\WINNT”  
b. Press the “OK” button.

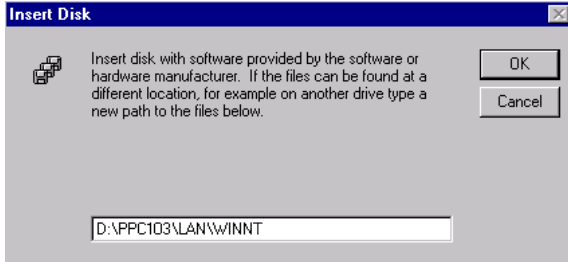

4. a. Choose the highlighted “RTL8139[A/B/C/8130] PCI Fast Ethernet Adapter.”  
b. Click the “OK” button.

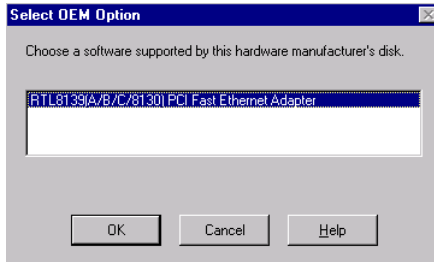

5. Choose a suitable RTL8139 Duplex mode for your application.

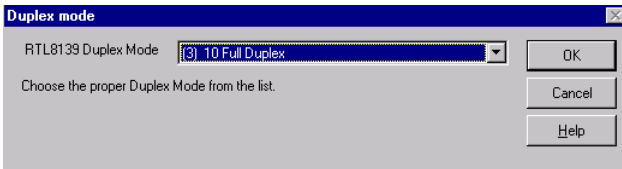

6. Finish the network configuration and then click the “OK” button.

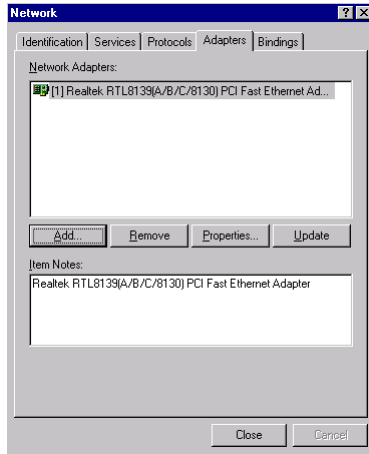

### 5.3 Further Information

Realtek website: [www.realtek.com.tw](http://www.realtek.com.tw)

Advantech websites: [www.advantech.com](http://www.advantech.com)  
[www.advantech.com.tw](http://www.advantech.com.tw)

# CHAPTER 6

## **PCI SVGA Setup**

- Introduction
- Installation of SVGA Driver
  - for Windows 95
  - for Windows 98
  - for Windows NT
  - for Windows 2000
- Further Information

## **6.1 Introduction**

The PPC-103 has an onboard AGP flat panel/VGA interface. The specifications and features are described as follows:

### **6.1.1 Chipset**

The PPC-103 uses a SMI Lynx EM4+ 710 chipset from Silicon Motion Inc. for its AGP/SVGA controller. It supports many popular LCD, EL, and gas plasma flat panel displays and conventional analog CRT monitors. The SMI 710 VGA BIOS supports monochrome LCD, EL, color TFT and STN LCD flat panel displays. In addition, it also supports interlaced and non-interlaced analog monitors (color and monochrome VGA) in high-resolution modes while maintaining complete IBM VGA compatibility. Digital monitors (i.e. MDA, CGA, and EGA) are NOT supported. Multiple frequency (multisync) monitors are handled as if they were analog monitors.

### **6.1.2 Display memory**

With onboard 4 MB display memory, the VGA controller can drive CRT displays or color panel displays with resolutions up to 1024 x 768 at 16 M colors.

### **6.1.3 Display types**

CRT and panel displays can be used simultaneously. The PPC-103 can be set in one of three configurations: on a CRT, on a flat panel display, or on both simultaneously. The system is initially set to simultaneous display mode.

## **6.2 Installation of SVGA Driver**

Complete the following steps to install the SVGA driver. Follow the procedures in the flow chart that apply to the operating system that you are using within your PPC-103.

*Important: The following windows illustrations are examples only. You must follow the flow chart instructions and pay attention to the instructions which then appear on your screen.*

*Note 1: The CD-ROM drive is designated as "D" throughout this chapter.*

*Note 2: <Enter> means pressing the "Enter" key on the keyboard.*

## 6.2.1 Installation for Windows 95

1.a. Select “Start” and “Run”

b. Enter the path “D:\PPC103\VGA\Win9x\setup.exe”

c. Press “OK”

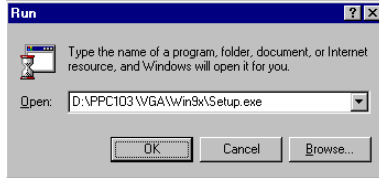

2. Press “Next”



3. Click “Finish” to complete the installation and restart your computer.

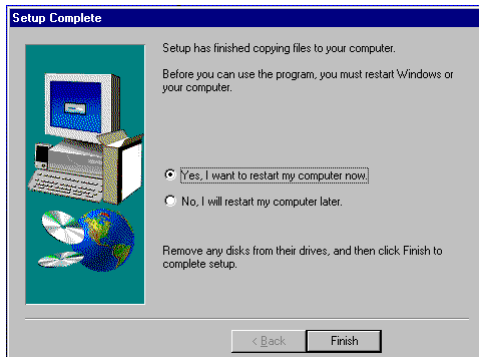

## 6.2.2 Installation for Windows 98

- 1.a. Select “Start” and “Run”
- b. Enter the path “D:\PPC103\VGA\Win9x\setup.exe”
- c. Press “OK”

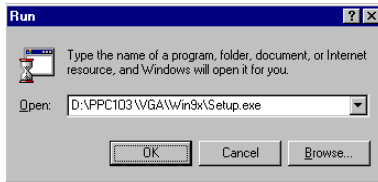

2. Press “Next”

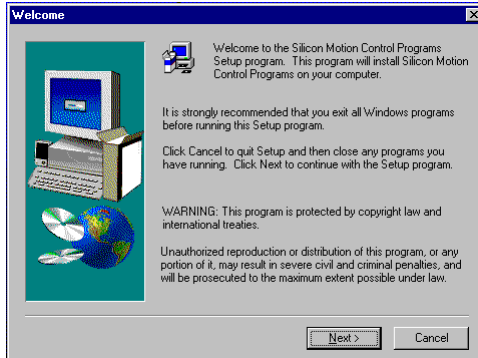

3. Click “Finish” to complete the installation and restart your computer.

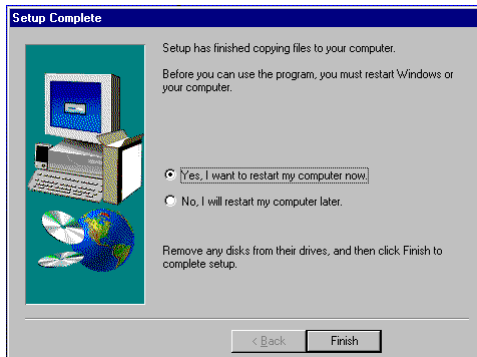

## 6.2.3 Installation for Windows NT

1.a. Select “Start” and “Run”

b. Enter the path “D:\PPC103\VGA\Win9x\setup.exe”

c. Press “OK”

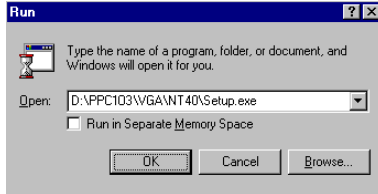

2. Press “Next”

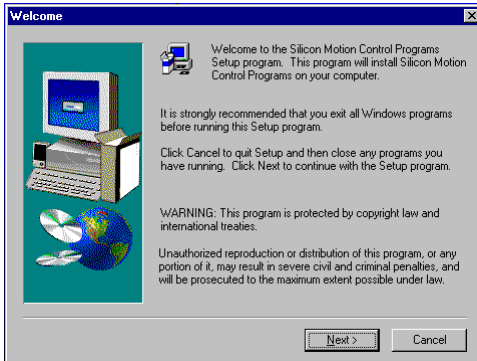

3. Click “Finish” to complete the installation and restart your computer.

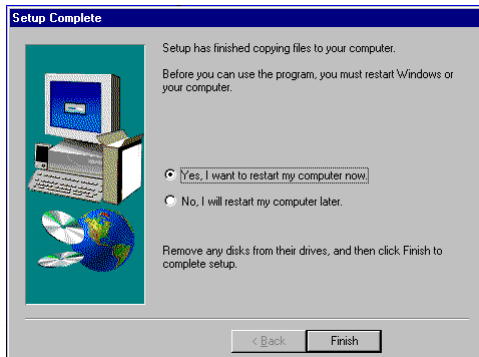

## 6.2.4 Installation for Windows 2000

1.a. Select "Start", "RUN"

b. Enter the path "D:\PPC103\VGA\Win2000\Setup.exe"

c. Press "OK"

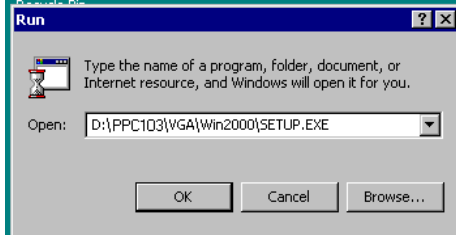

2. Press "Next"



3. When installation is completed, Click "Finish" to restart your computer.

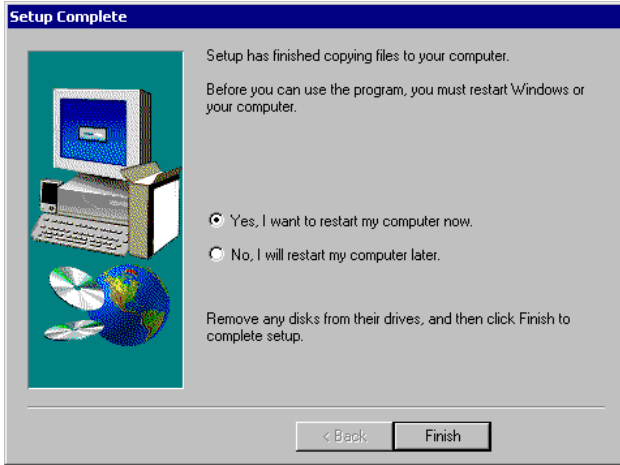

### 6.3 Further Information

For further information about the AGP/SVGA installation in your PPC-103, including driver updates, troubleshooting guides and FAQ lists, visit the following web resources:

Silicon Motion website: [www.siliconmotion.com](http://www.siliconmotion.com)

Advantech websites: [www.advantech.com](http://www.advantech.com)  
[www.advantech.com.tw](http://www.advantech.com.tw)

# CHAPTER 7

## **Audio**

- Introduction
- Installation of Audio Driver
  - for Windows 95/98
  - for Windows NT
  - for Windows 2000

## 7.1 Introduction

The PPC-103's onboard audio interface provides high-quality stereo sound and FM music synthesis (ESFM) by using the ES1938S audio controller from ESS Technology, Inc. The audio interface can record, compress, and play back voice, sound, and music with a built-in mixer control. The PPC-103's onboard audio interface also supports the Plug and Play (PnP) standard and provides PnP configuration for audio, FM, and MPU-104 logical devices. It is compatible with Sound Blaster, Sound Blaster Pro version 3.01, voice, and music functions. The ESFM synthesizer is register compatible with the OPL3 and has extended capabilities.

## 7.2 Installation of Audio Driver

Before installing the audio driver, please take note of the procedures detailed below. You must know which operating system you are using in your PPC-103, and then refer to the corresponding installation flow chart. Just follow the steps in the flow chart. You can quickly and successfully complete the installation, even though you are not familiar with instructions for Windows.

*Important: The following windows illustrations are examples only. You must follow the flow chart instructions and pay attention to the instructions which then appear on your screen.*

*Note 1: The CD-ROM drive is designated as "D" throughout this chapter.*

*Note 2: <Enter> means pressing the "Enter" key on the keyboard.*

## 7.2.1 Installation for Windows 95/98

1. a. Select “Start” and “Run”  
b. Enter the driver path  
“D:\PPC103\Audio\Win9x(only)\Setup.exe”

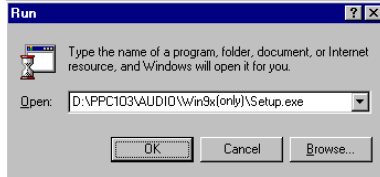

2. Click “Next” to continue the installation



3. a. Select “Upgrade Drivers”  
b. Click “Next”

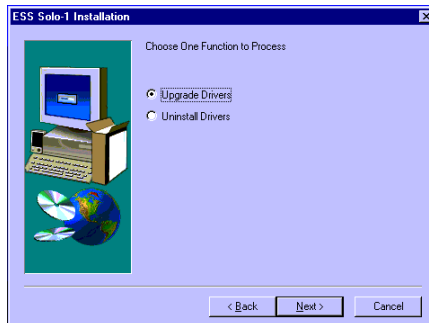

4. Click “Finish” to complete the installation and restart your computer.

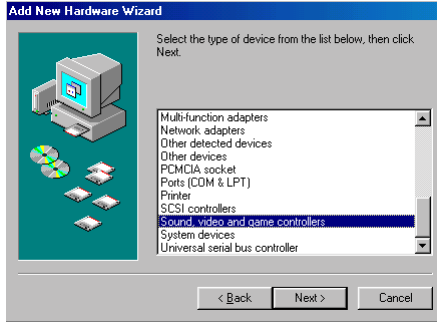

5. a. After installation, select “Start,” “Settings,” “Control Panel,” “System”  
b. Click the “Device Manager” tab to see the result of your installation.

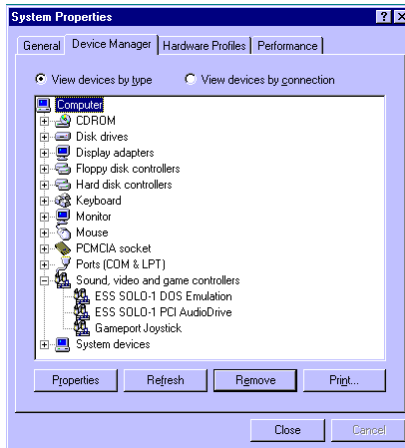

## 7.2.2 Installation for Windows NT

1. a. Select “Start,” “Setting” and “Control Panel”
- b. Double click the “Multimedia” icon.



2. a. Select the “Devices” item.
- b. Click the “Add...” button.

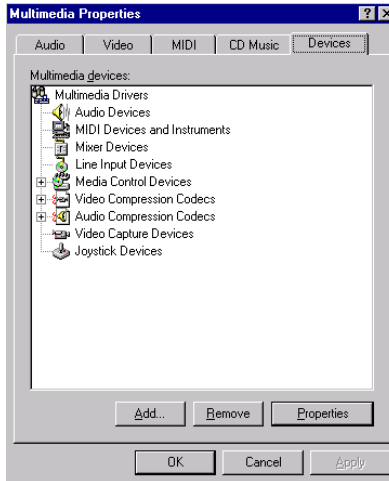

3. a. Choose the “Unlisted or Updated Driver” item.
- b. Click the “OK” button.

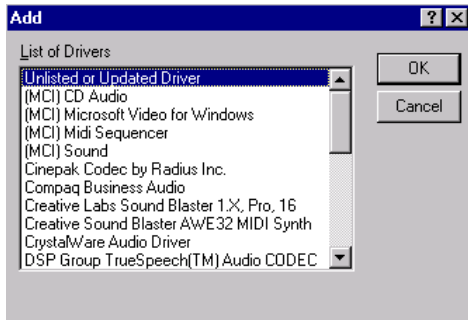

4. a. Type the path “D:\PPC103\audio\nt4.0\”
- b. Click the “OK” button.

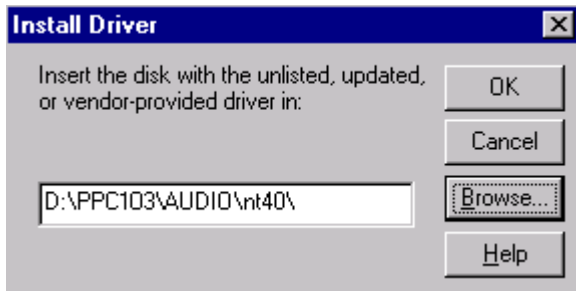

5. a. Select the highlighted item.
- b. Press the “OK” button.

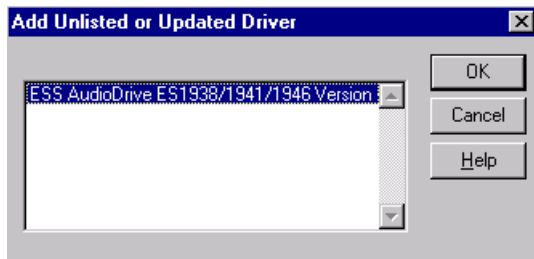

6. Press the “Restart Now” button to reboot your computer.

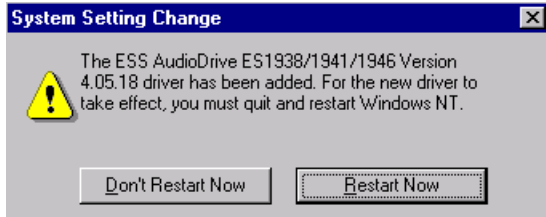

### 7.2.3 Installation for Windows 2000

1. a. Select "Start", "Program," "Accessories," "Windows Explorer"
- b. Select the path "D:\PPC103\Audio\Win2000"
- c. Double-click the "Setup" icon.

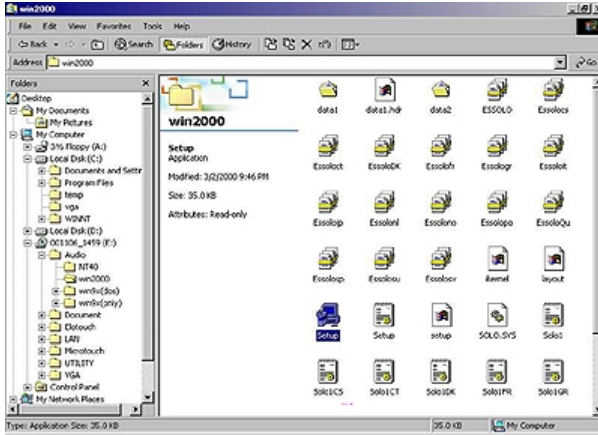

2. Press "Next"



3. Click "OK"



4. Click "Finish" to complete the installation.

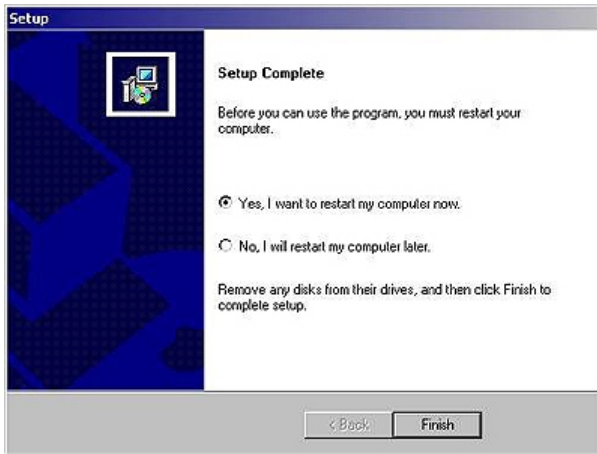



# CHAPTER 8

## **Touchscreen**

- Introduction
- Installation of Driver for Resistive or SAW

### Touchscreen

- for Windows 95
- for Windows 98
- for Windows NT
- for Windows 2000
- Installation of Driver for Capacitive Touchscreen
  - for Windows 95/98/NT
  - for Windows 2000

## 8.1 Introduction

### 8.1.1 General information

The PPC-103's optional touchscreen incorporates advanced second-generation 5-wire resistive technology. They allow 75% light transmission. The resistive model has an antiglare surface. All models provide greatly enhanced visual resolution. They also have new improved scratch-resistant features. The touchscreen is manufactured from UL-recognized components. When properly installed, the touchscreen's ball impact resistance meets the UL 1950 standard. Its fire resistance meets the UL-746C, 19 mm (0.75") flame test standard. Systems incorporating the touchscreen, controllers, and cables have been approved to FCC Class B and Class B standards. For more detailed information, please visit the following websites:

Resistive and SAW models: [www.elotouch.com](http://www.elotouch.com)

### 8.1.2 General specifications

Please refer to Chapter 1, Section 1.3 of this manual.

### 8.1.3 Environmental specifications

**Temperature:** -10° ~ 50° C (operating)  
-40° ~ 71° C (storage)

**Relative humidity:** 90 RH at 35° C (operating)  
90 RH at 35° C for 240 hours, non-condensing (storage)

**Chemical resistance:** The active area of the touchscreen is resistant to the following chemicals when exposed for a period of one hour at a temperature of 21° C (71° F):

- Acetone
- Methylene chloride
- Methyl ethyl ketone

- Isopropyl alcohol
- Hexane
- Ammonia-based glass cleaners
- Turpentine
- Mineral spirits
- Foods and beverages

## **8.2 Installation of Driver for Resistive or SAW Touchscreen**

The touchscreen driver for Windows 95/98 contains a native, 32-bit driver and a 32-bit control panel program for the PPC-103 system.

To facilitate installation of the touchscreen driver, you should read the instructions in this section carefully before you attempt installation.

*Important:* The following windows illustrations are examples only. You must follow the flow chart instructions and pay attention to the instructions which then appear on your screen.

*Note 1:* The CD-ROM drive is designated as "D" throughout this chapter.

*Note 2:* <Enter> means pressing the "Enter" key on the keyboard.

## 8.2.1 Installation for Windows 95

1. a. Insert the “Driveres and Utilities” CD  
b. Click the “Start” button and then “Run.”  
c. Type the path “D:\\PPC103\\Elotouch\\Win95\\Setup.exe”

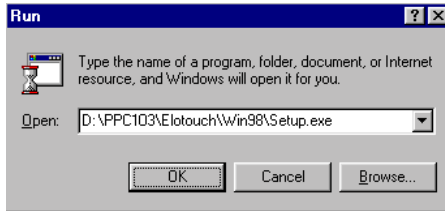

2. Click “Yes”.

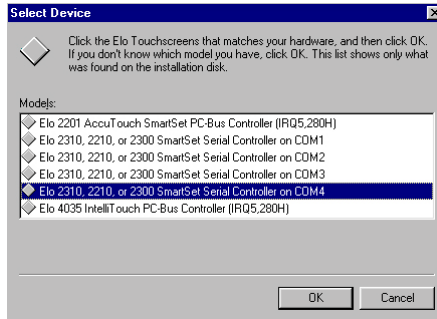

- 3 a. Select the “SmartSet Serial Controller on COM4” item.  
b. Press “OK”

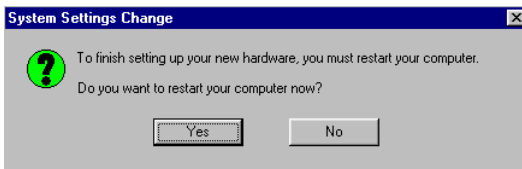

## 5. Touch targets to calibrate the touchscreen controller.

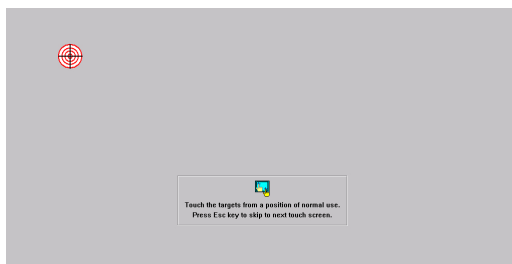

## 8.2.2 Installation for Windows 98

1. a. Insert the “Drivers and Utilites” CD.  
b. Click the “Start” button and then “Run”  
c. Type the path “D:\PPC103\Elotouch\Win98\Setup.exe”

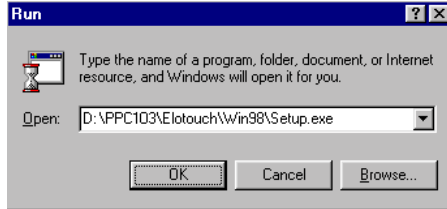

2. Click “Yes”

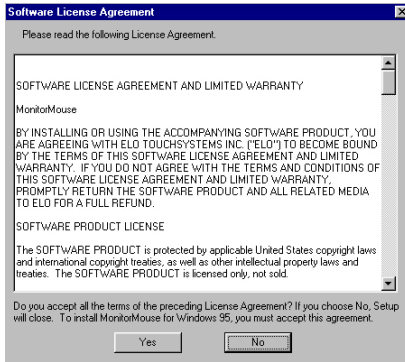

3. a. Select the “SmartSet Serial Controller on COM4” item.  
b. Press the “OK” button.

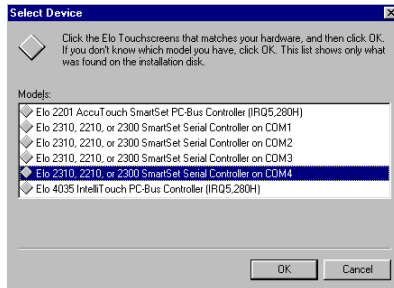

4. Click the “Yes” button to restart your computer.



5. Touch target to calibrate the touchscreen controller.

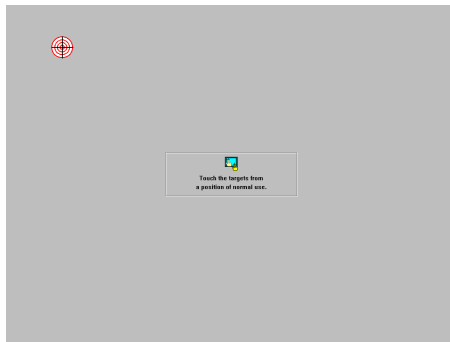

## 8.2.3 Installation for Windows NT

1. a. Select "Start" and "Run"
- b. Type the path "D:\PPC103\Elotouch\WINNT\Setup.exe"

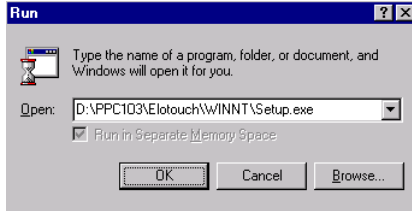

2. Press the "Next" button.

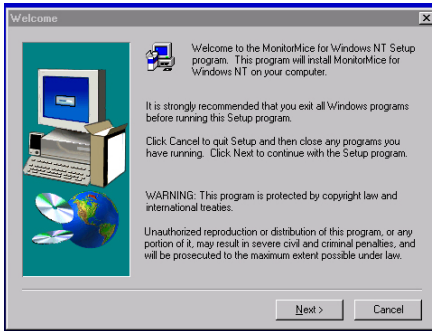

3. Set the directory path.

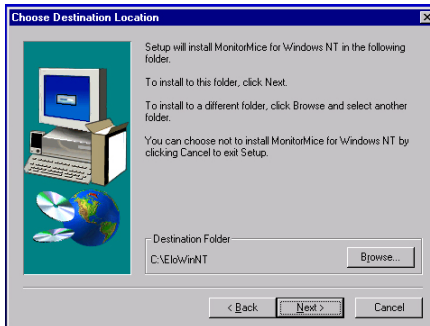

4. Choose a suitable item.

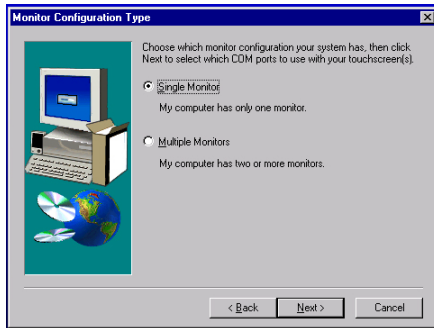

5. a. Choose “COM4”  
b. Press “Next”

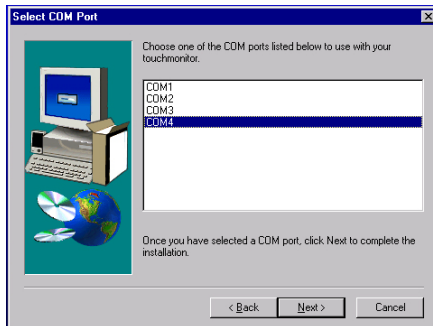

6. Click “Finish” to restart your computer.

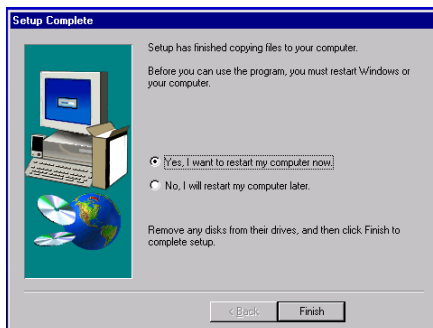

## 7. Calibrate the touchscreen.

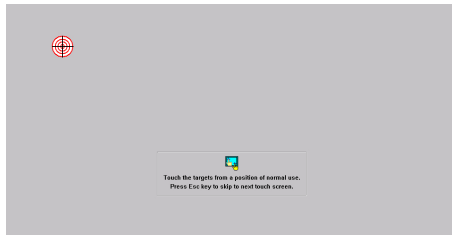

## 8.2.4 Installation for Windows 2000

### 1. Click “Setup”

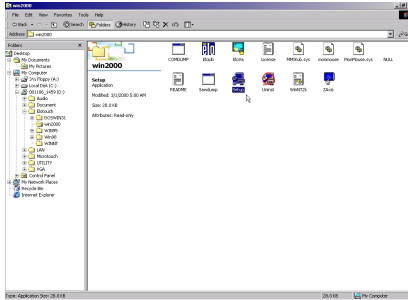

### 2. Click “Next”

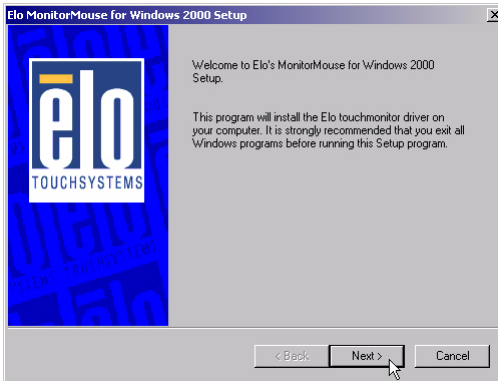

### 3. Click “Yes”

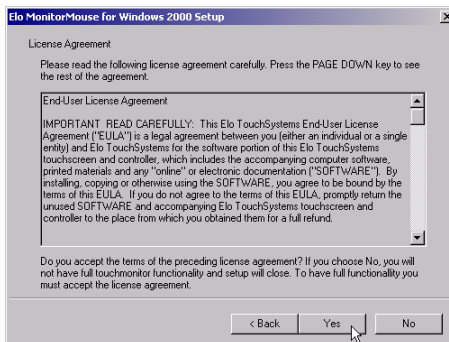

4. a. Select “COM4”
- b. Click “Next”

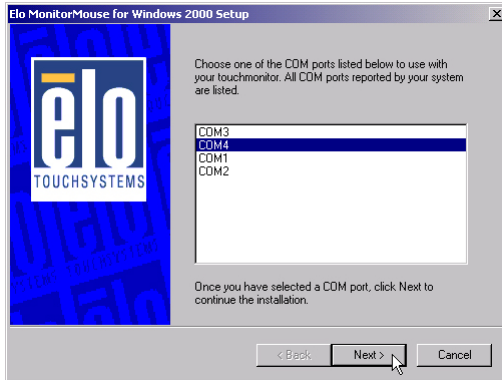

5. Click “Yes”

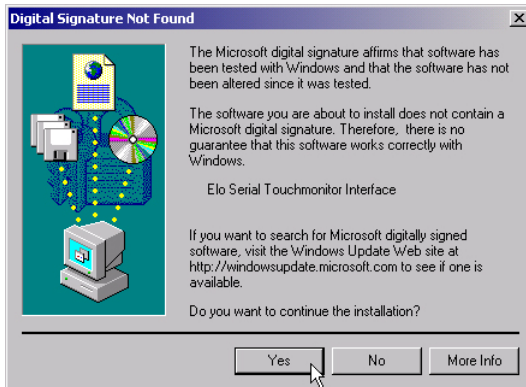

6. Click “Finish”

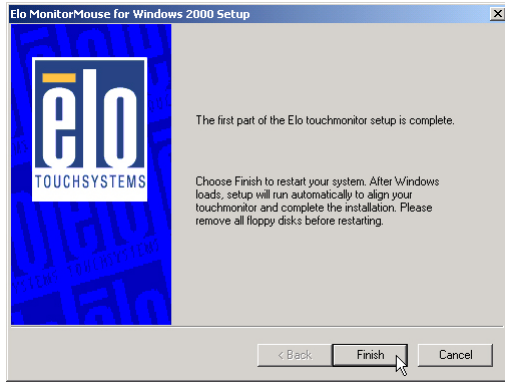

7. a. Click “Yes”

b. After the system reboots, click “Finish” to complete the installation.

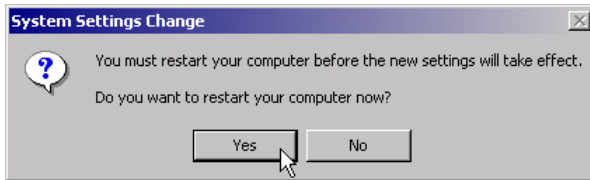



# CHAPTER A

## **Programming the Watchdog Timer**

The PPC-103 is equipped with a watchdog timer that resets the CPU or generates an interrupt if processing comes to a standstill for whatever reason. This feature ensures system reliability in industrial stand-alone or unmanned environments.

## A.1 Programming the Watchdog Timer

In order to program the watchdog timer, you must write a program which writes I/O port address 443 (hex). The output data is a value of time interval. The value range is from 01 (hex) to 3F (hex), and the related time interval is 1 sec. to 62 sec.

Data	Time Interval
01	1 sec.
02	2 sec.
03	3 sec.
04	4 sec.
	.
	.
	.
3F	63 sec.

After data entry, your program must refresh the watchdog timer by rewriting the I/O port 443 (hex) while simultaneously setting it. When you want to disable the watchdog timer, your program should read I/O port 443 (hex).

The following example shows how you might program the watchdog timer in BASIC:

```
10 REM Watchdog timer example program
20 OUT &H443, data REM Start and restart the
watchdog
30 GOSUB 1000 REM Your application task #1
40 OUT &H443, data REM Reset the timer
50 GOSUB 2000 REM Your application task #2
60 OUT &H443, data REM Reset the timer
70 X=INP (&H443) REM Disable the watchdog timer
80 END

1000 REM Subroutine #1, you application task
.
.
.
1070 RETURN
2000 REM Subroutine #2, you application task
.
.
.
2090 RETURN
```

# APPENDIX **B**

## **Power Supply Specifications**

- Introduction
- Input Specifications
- Output Specifications
- Mechanical Specifications
- Environmental Specifications
- Features

## B.1 Introduction

The power supply of the PPC-103 is a 60 W double output, universal input switching power supply. It has been designed for medical technology applications.

## B.2 Input Specifications

- **Input voltage:**  $85 V_{AC}$  to  $264 V_{AC}$
- **Input frequency:** 47 Hz to 63 Hz at AC input
- **Input current:** Less than 2 A at  $115 V_{AC}$  or 1.5 A at  $230 V_{AC}$
- **Inrush current:** Will not exceed 30 A at  $115 V_{AC}$  input or 60 A at  $230 V_{AC}$  input, cold start at  $25^{\circ}C$

## B.3 Output Specifications

Table B-1: Load range

Output	Min Load	Rated Load	Peak Load	Voltage Accuracy
+5 V	0 A	5 A	8 A	4.95 ~ 5.05 V
+12 V	0 A	3 A	5.5 A	11.4 ~ 12.6 V

**Factory settings:** The adjustable range of the +5 V output is from about 4.5 to 6 V. The +5 V output is factory-set between 4.95 and 5.05 V at 60% of the rated load. Similarly, the +12 V output is checked at the factory, to ensure that it is within the specified voltage accuracy range. The peak load can take less than 5 seconds to reach.

**Ripple peak and noise:** The peak to peak ripple and noise for each output is less than 1% of the output voltage. Measuring and termination of each output is done with a 15 MHz bandwidth limited oscilloscope with a 0.47  $\mu F$  capacitor.

**Line regulation:** The line regulation for each output is less than  $\pm 1\%$  of the rated load and  $\pm 10\%$  for input voltage changing.

**Load regulation:** The load regulation for +5 V is less than  $\pm 1\%$ . For +12 V, it is less than  $\pm 5\%$ . Measuring is performed by changing the measured output load  $\pm 40\%$  from 60% of the rated load, and keeping other outputs at 60% of the rated load.

## B.4 Mechanical Specifications

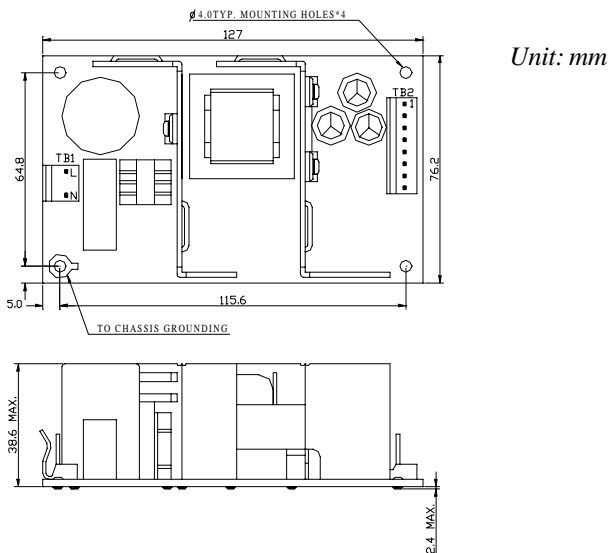

*Figure B-a: PPC-103 dimensions diagram*

**Dimensions:** Shown in mm as above. Tolerance specified is  $\pm 0.4$  mm.

### **Connectors:**

TB1 - AC input: Using Molex 5277-02A or equivalent.

TB2 - DC output: Using Molex 5273-08A or equivalent.

### **DC output pin assignments:**

Pin	1	+5 V
	2	+5 V
	3	GND
	4	GND
	5	GND
	6	GND
	7	+12 V
	8	+12 V

## B.5 Environmental Specifications

**Operating temperature:** 0 ~ 50° C, rated load

**Storage temperature:** -40 ~ 85° C

## B.6 Features

**Efficiency:** Higher than 70% (typical) while measuring at nominal line and rated load.

**Hold up time:** Longer than 16 ms at 115 V<sub>AC</sub> input and rated load, which is measured from the end of the last charging pulse to when the main output drops down to 95% output voltage.

**Protection:** If the power supply fails to control itself, the built-in excess voltage protection circuit will shut down the outputs to avoid damaging external circuits. The trip point of the crowbar circuit is around 5.7 V to 7.0 V for output voltage. The power supply will go into latch-off mode under short circuit or overload conditions. Recovery from these adverse conditions should be set as cycle AC, input OFF and ON.

**Safety ground leakage current:** It should be less than 100 µA at 244 V<sub>AC</sub> input.

## International standards

### Safety standards:

Designed to meet the following standards:

- UL544
- CSA 22.2 NO.601
- TUV (DIN. VDE 0750T.1/12.91/EN 60601-1:1990)

### EMI standards:

Designed to met the following limits:

- FCC docket 20780 curve "B"
- EN55011 "B"
- EN61000-3-2

**EMS standards:**

- IEC-801-2-8: kV air discharge criteria B
- IEC-801-3-3: V/m
- IEC-801-4: 0.5 kV



**APPENDIX**

**C**

**I/O Pin Assignments**

## Keyboard connector (CN5-1)

---

Keyboard connector

---

Pin	Signal
1	KB_DT
2	N/A
3	GND
4	+5 V
5	KB_CK
6	N/A

---

## Mouse connector (CN5-2)

---

Mouse connector

---

Pin	Signal
1	MS_DT
2	N/A
3	GND
4	+5 V
5	MS_CK
6	N/A

---

## VGA connector (CN6)

VGA connector	
Pin	Signal
1	RED
2	GREEN
3	BLUE
4	N/A
5	GND
6	GND
7	GND
8	GND
9	N/A
10	GND
11	N/A
12	N/A
13	HSYNC
14	VSYNC
15	N/A

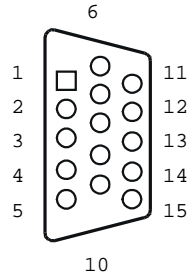

## COM1 RS-232 serial port (CN1-2)

COM1 RS-232 serial port	
Pin	Signal
1	DCD
2	RxD
3	TxD
4	DTR
5	GND
6	DSR
7	RTS
8	CTS
9	RI

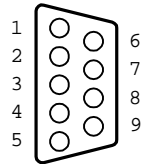

### COM3 RS-232 serial port (CN2-1)

COM3 RS-232 serial port	
Pin	Signal
1	DCD
2	RxD
3	TxD
4	DTR
5	GND
6	DSR
7	RTS
8	CTS
9	RI

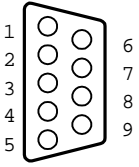

### COM4 RS-232 serial port (CN2-2)

COM4 RS-232 serial port	
Pin	Signal
1	DCD
2	RxD
3	TxD
4	DTR
5	GND
6	DSR
7	RTS
8	CTS
9	RI

## COM2

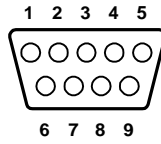

Table D-21: COM2

<b>Pin</b>	<b>Signal</b>	<b>RS-232</b>	<b>RS-422</b>	<b>RS-485</b>
1	DCD	TX-	DATA-	
2	RX	TX+	DATA+	
3	TX	RX+	---	
4	DTR	RX-	---	
5	GND	GND	---	
6	DSR	---	---	
7	RTS	---	---	
8	CTS	---	---	
9	RI	---	---	

## Parallel port connector (CN1-1)

Parallel port connector	
Pin	Signal
1	STROBE*
2	D0
3	D1
4	D2
5	D3
6	D4
7	D5
8	D6
9	D7
10	ACK*
11	BUSY
12	PE
13	SLCT
14	AUTOFD*
15	ERR*
16	INIT*
17	SLCTINI*
18	GND
19	GND
20	GND
21	GND
22	GND
23	GND
24	GND
25	GND

\* active low

