

**PCM-9550F**

**PCM-9550FM**

**PCM-9550L**

EBX Pentium® SBC with CPU, LCD,  
Ethernet, Audio, DIO, and  
PC/104-Plus

**User's Manual**

## Copyright Notice

This document is copyrighted, 2000. All rights are reserved. The original manufacturer reserves the right to make improvements to the products described in this manual at any time without notice.

No part of this manual may be reproduced, copied, translated or transmitted in any form or by any means without the prior written permission of the original manufacturer. Information provided in this manual is intended to be accurate and reliable. However, the original manufacturer assumes no responsibility for its use, nor for any infringements upon the rights of third parties that may result from such use.

## Acknowledgments

Award is a trademark of Award Software International, Inc.

C&T is a trademark of Chips and Technologies, Inc.

IBM, PC/AT, PS/2 and VGA are trademarks of International Business Machines Corporation.

Intel and Pentium are trademarks of Intel Corporation.

Microsoft Windows® is a registered trademark of Microsoft Corp.

RTL is a trademark of Realtek Semi-Conductor Co., Ltd.

SiS is a trademark of Silicon Integration Systems Corporation

UMC is a trademark of United Microelectronics Corporation.

IDT is a trademark of Integrated Device Technology , Inc.

Creative is a trademark of Creative Technology LTD.

All other product names or trademarks are properties of their respective owners.

For more information on this and other Advantech products, please visit our websites at:

**<http://www.advantech.com>**

**<http://www.advantech.com/epc>**

For technical support and service, please visit our support website at:

**<http://support.advantech.com>**

This manual is for the PCM-9550F and PCM-9550FM, and PCM-9550L.

Part No. 2006955013

4th Edition Printed in Taiwan © Nov., 2001

## Packing list

---

Before you begin installing your card, please make sure that the following materials have been shipped:

- 1 PCM-9550F/FM/L all-in-one single board computer
- 1 CD disk for utility and drivers
- 1 startup manual
- 1 Power cable (p/n: 1703080101)

If any of these items are missing or damaged, contact your distributor or sales representative immediately.

Please refer to Appendix E, Section E.1 for the optional interface wiring kits.

	PCM-9550 FM	PCM-9550 F	PCM-9550 L
Video-In	✓	-	-
TV-Out	✓	-	-
Audio	✓	✓	-
CFC	✓	✓	-
Digital IO	✓	✓	-
Mini PCI	✓	✓	-
PC/104 +	✓	✓	-
LPT	2	2	1
Share IRQ	✓	✓	-

PCM-9550FM/9550F/9550L  
Model Comparison Table

# Contents

## Chapter 1 General Information..... 1

<b>1.1 Introduction .....</b>	<b>2</b>
Highly integrated multimedia SBC .....	2
<b>1.2 Features .....</b>	<b>3</b>
<b>1.3 Specifications .....</b>	<b>4</b>
1.3.1 Standard EBX SBC functions .....	4
1.3.2 PCI SVGA/flat panel interface .....	5
1.3.3 Digital I/O .....	5
1.3.4 Audio function .....	6
1.3.5 Video function (PCM-9550FM only) .....	6
1.3.6 PCI bus Ethernet interface .....	6
1.3.7 Mechanical and environmental .....	6
<b>1.4 Board layout and dimensions .....</b>	<b>7</b>

## Chapter 2 Installation..... 9

<b>2.1 Jumpers .....</b>	<b>10</b>
<b>2.2 Connectors .....</b>	<b>10</b>
<b>2.3 Locating jumpers .....</b>	<b>12</b>
<b>2.4 Locating connectors .....</b>	<b>13</b>
2.4.1 Component side .....	13
2.4.2 Solder side .....	14
<b>2.5 Setting jumpers .....</b>	<b>15</b>
<b>2.6 CMOS clear (J3) .....</b>	<b>16</b>
<b>2.7 Installing system memory (DIMMs) .....</b>	<b>17</b>
2.7.1 Installing DIMMs .....	17
<b>2.8 IDE, CDROM hard drive connector (CN16, CN17) .....</b>	<b>17</b>
2.8.1 Connecting the hard drive .....	18
<b>2.9 Solid State Disk .....</b>	<b>19</b>
2.9.1 CompactFlash (CN30) .....	19
2.9.2 DiskOnChip 2000 Address setting (J8) .....	19
<b>2.10 Floppy drive connector (CN19) .....</b>	<b>20</b>
2.10.1 Connecting the floppy drive .....	20
<b>2.11 Parallel port connector (CN21, CN22) .....</b>	<b>21</b>
<b>2.12 Keyboard and PS/2 mouse connector (CN10) .....</b>	<b>21</b>
<b>2.13 Front panel connector (CN13) .....</b>	<b>22</b>

2.13.1	Speaker .....	22
2.13.2	LED interface .....	22
2.13.3	Watchdog output .....	22
2.13.4	Reset switch .....	22
<b>2.14</b>	<b>Power connectors (CN24, CN8, CN26) .....</b>	<b>23</b>
2.14.1	Peripheral power connector, -5 V, -12 V (CN26) .....	23
2.14.2	Main power connector, +5 V, +12 V (CN8) .....	23
2.14.3	CPU Fan power supply connector (CN24) .....	23
<b>2.15</b>	<b>ATX power control connector (J4, CN5) .....</b>	<b>24</b>
2.15.1	ATX feature connector (CN5) and soft power switch connector (J4) .....	24
<b>2.16</b>	<b>IR connector (CN27) .....</b>	<b>25</b>
<b>2.17</b>	<b>Audio interfaces (CN2, CN11) .....</b>	<b>25</b>
2.17.1	Audio connector (CN12) .....	25
2.17.2	CD audio input connector (CN11) .....	25
2.17.3	Audio power source setting (J7) .....	26
<b>2.18</b>	<b>COM port connector (CN20) .....</b>	<b>27</b>
2.18.1	COM2 RS-232/422/485 setting (J9) .....	27
2.18.2	Share IRQ .....	28
2.18.3	COM port RI pin setting (J10) .....	28
<b>2.19</b>	<b>VGA interface connections .....</b>	<b>30</b>
2.19.1	CRT display connector (CN1) .....	30
2.19.2	Flat panel display connector (CN14) .....	30
2.19.3	Extension flat panel connector (CN9) .....	30
2.19.4	LCD power setting .....	31
<b>2.20</b>	<b>VGA/TV-Out function select (J1) .....</b>	<b>31</b>
<b>2.21</b>	<b>Video In/Out interfaces (CN2) (PCM-9550FM only) .....</b>	<b>31</b>
<b>2.22</b>	<b>Ethernet configuration .....</b>	<b>33</b>
2.22.1	100Base-T connector (CN16) .....	33
2.22.2	Network boot .....	33
2.22.3	LAN controller power select (J6) .....	33
<b>2.23</b>	<b>Watchdog timer configuration .....</b>	<b>34</b>
2.23.1	Watchdog timer action (J11) .....	34
<b>2.24</b>	<b>USB connectors (CN15) .....</b>	<b>35</b>
<b>2.25</b>	<b>Digital I/O (CN28: 8 Outputs, 8 Inputs) .....</b>	<b>35</b>
2.25.1	Digital output programming .....	37
2.25.2	Digital Input programming .....	37

## **Chapter 3 Software Configuration ..... 39**

<b>3.1 Introduction .....</b>	<b>40</b>
<b>3.2 Connections for five standard LCDs .....</b>	<b>40</b>
3.2.1 Connections to Sharp LM64183P, LM64P89 (640 x 480 DSTN MONO LCD) .....	40
3.2.2 Connections to PLANAR EL (640 x 480 AD4 EL) .....	41
3.2.3 Connections to Toshiba LTM10C042 (640 x 480 TFT color LCD) .....	42
3.2.4 Connections to Sharp LM64C142 (640 x 480 DSTN color LCD) .....	43
3.2.5 Connections to Toshiba LTM12C275A (800 x 600 TFT color LCD) .....	44
<b>3.3 Ethernet software configuration .....</b>	<b>45</b>

## **Chapter 4 Award BIOS Setup ..... 47**

<b>4.1 System test and initialization .....</b>	<b>48</b>
4.1.1 System configuration verification .....	48
<b>4.2 AWARD BIOS setup .....</b>	<b>49</b>
4.2.1 Entering setup .....	49
4.2.2 Standard CMOS setup .....	50
4.2.3 BIOS features setup .....	51
4.2.4 Chipset features setup .....	52
4.2.5 Power management setup .....	53
4.2.6 PnP/PCI configuration .....	54
4.2.7 Integrated peripherals .....	55
4.2.8 Load BIOS defaults .....	56
4.2.9 Change password .....	57
4.2.10 Auto detect hard disk .....	58
4.2.11 Save & exit setup .....	58
4.2.12 Exit without saving .....	58

## **Chapter 5 PCI SVGA Setup ..... 59**

<b>5.1 Introduction .....</b>	<b>60</b>
5.1.1 Chipset .....	60
5.1.2 Display memory .....	60
5.1.3 Display types .....	60
<b>5.2 Installation of SVGA driver .....</b>	<b>61</b>
5.2.1 Installation for Windows 95/98 .....	62
5.3.2 Installation for Windows 3.1 .....	67
5.3.3 Installation for Windows NT .....	71
<b>5.4 Further information .....</b>	<b>75</b>

<b>Chapter 6 Video .....</b>	<b>77</b>
6.1 Introduction .....	78
6.2 Installation of video driver .....	78
6.2.1 Installation for Windows 95/98 .....	79
6.3 Installation of Chips-TV utility .....	83
<b>Chapter 7 Audio .....</b>	<b>85</b>
7.1 Introduction .....	86
7.2 Installation of audio driver .....	86
7.2.1 Installation for Windows 95/98/NT .....	87
<b>Chapter 8 PCI Bus Ethernet Interface .....</b>	<b>91</b>
8.1 Introduction .....	92
8.2 Installation of Ethernet driver .....	92
8.2.1 Installation for MS-DOS and Windows 3.1 .....	92
8.2.2 Installation for Windows 95/98 .....	93
8.2.3 Installation for Windows NT .....	96
8.3 Further information .....	100
<b>Appendix A Programming the Watchdog Timer .....</b>	<b>101</b>
A.1 Programming the watchdog timer .....	102
<b>Appendix B Installing PC/104-Plus Modules .....</b>	<b>105</b>
B.1 Installing PC/104 modules .....	106
<b>Appendix C Pin Assignments .....</b>	<b>109</b>
C.1 CPU fan power connector (CN24) .....	110
C.2 Ethernet 10/100Base-T connector (CN6) .....	110
C.3 Audio connector (CN12) .....	111
C.4 CD audio input connector (CN11) .....	112
C.5 Main power connector (CN8) .....	113
C.6 Keyboard and PS/2 mouse connector (CN10) .....	114
C.7 Floppy disk drive connector (CN19) .....	115
C.8 PC/104+ connectors (CN18) .....	116
C.9 IDE HDD connector (CN16, 17) .....	119
C.10 Parallel port connector (CN21, CN22) .....	120

C.11 Front panel connector (CN13) .....	121
C.12 USB connector (CN15) .....	122
C.13 LCD inverter backlight connector (CN7) .....	122
C.14 IR connector (CN27) .....	123
C.15 CRT display connector (CN1) .....	123
C.16 Video in/out connector (CN2) .....	124
C.17 24-bit LCD display connector (CN14) .....	125
C.18 36-bit LCD display connector (CN9) .....	126
C.20 CompactFlash™ card connector (CN30) .....	127
C.19 Peripheral power connector (CN26) .....	127
C.21 ATX power feature connector (CN5) .....	128
C.22 Digital I/O (CN23) .....	129
C.23 Isolated 2 Digital Out (CN28) .....	129
C.24 COM port connector (CN20) .....	130

## **Appendix D System Assignments ..... 131**

D.1 System I/O ports .....	132
D.2 1st MB memory map .....	133
D.3 DMA channel assignments .....	133
D.4 Interrupt assignments .....	134

## **Appendix E Optional Extras for the PCM-9550F/M ..... 135**

E.1 PCM-10586-5000/500M cable kit for PCM-9550F/FM .....	136
E.2 Optional LCD cables for 9.4" MONO, 10.4" TFT LCD panel (CN14) .....	137
E.3 Optional USB cable (CN16) .....	137
E.4 ATX Power Control Cable (CN5) .....	137
E.5 Optional PC/104+ to PCI Module .....	137
E.6 Optional 24 bit LCD cable adaptor .....	137

## **Mechanical Drawings ..... 139**

F.1 Component side .....	140
F.2 Solder side .....	141

# Tables

PCM-9550FM/9550F/9550L Model Comparison Table .....	iii
Table 2-1: Jumpers .....	10
Table 2-2: Connector Assignments .....	11
Table 2-3: CMOS clear (J3) .....	16
Table 2-4: J8: DOC-2000 address setting .....	19
Table 2-5: Audio power source setting .....	26
Table 2-6: J9: COM2 RS-232/422/485 select .....	27
Table 2-7: Serial port default settings .....	28
Table 2-8: J10: COM1-4 RI settings .....	29
Table 2-9: VGA/TV-Out function select (J1) .....	31
Table 2-10: J2 TV out format select .....	32
Table 2-11: LAN controller power select (J6) .....	33
Table 2-12: Watchdog timer action (J11) .....	34
Table 2-13: Digital output programming .....	37
Table 2-14: Digital input programming .....	37
Table 3-1: Connections to Sharp LM64183P & LM64P89 .....	40
Table 3-2: Connections to PLANAR EL .....	41
Table 3-3: Connections to Toshiba LTM10DC042 .....	42
Table 3-4: Connections to Sharp LM64C142 .....	43
Table C-1: CPU fan power connector (CN24) .....	110
Table C-2: Ethernet 10/100Base-T connector (CN6) .....	110
Table C-3: Audio connector (CN12) .....	111
Table C-4: Aux line-in connector (CN11) .....	112
Table C-5: Main power connector (CN8) .....	113
Table C-6: Keyboard and mouse connector (CN10) .....	114
Table C-7: Floppy disk drive connector (CN19) .....	115
Table C-8: PC/104+ connectors (CN18) .....	116
Table C-9: PC/104+ Bus signal assignments (CN18) .....	118
Table C-10: IDE HDD connector (CN16, CN17) .....	119
Table C-11: Parallel port connector (CN21, CN22) .....	120
Table C-12: Front panel connector (CN13) .....	121
Table C-13: USB connector (CN15) .....	122
Table C-14: LCD inverter connector (CN7) .....	122
Table C-15: IR connector (CN27) .....	123
Table C-16: CRT display connector (CN1) .....	123
Table C-17: Video in/out connector (CN2) .....	124

Table C-18: 24-bit LCD display connector (CN14) .....	125
Table C-19: 36-bit LCD display connector (CN9) .....	126
Table C-20: Peripheral power connector (CN26) .....	127
Table C-21: CompactFlash Card Connector (CN30) .....	127
Table C-22: ATX power feature connector (CN5) .....	128
Table C-23: Digital I/O (CN23) .....	129
Table C-24: Isolated Digital Out (CN28) .....	129
Table C-25: COM port connector (CN20) .....	130
Table D-1: System I/O ports .....	132
Table D-2: 1st MB memory map .....	133
Table D-3: DMA channel assignments .....	133
Table D-4: Interrupt assignments .....	134

# Figures

Figure 1-1: PCM-9550 dimensions .....	7
Figure 2-1: Locating jumpers .....	12
Figure 2-2: Locating connectors (component side) .....	13
Figure 2-3: Locating connectors (solder side) .....	14
Figure 2-4: Wiring for ATX soft power switch function .....	24
Figure 2-5: CN 28 Digital Input/Output .....	35
Figure 2-5: Digital opto Isolated output block diagram .....	36
Figure 4-1: Setup program initial screen .....	49
Figure 4-2: CMOS setup screen .....	50
Figure 4-3: BIOS features setup .....	51
Figure 4-4: Chipset features setup .....	52
Figure 4-5: Power management setup .....	53
Figure 4-6: PnP/PCI configuration .....	54
Figure 4-7: Integrated peripherals .....	55
Figure 4-8: Load BIOS defaults screen .....	56
Figure B-1: PC/104+ module mounting diagram .....	107
Figure B-2: PC/104+ module dimensions (mm) ( $\pm 0.1$ ) .....	107



# CHAPTER 1

## General Information

This chapter gives background information on the PCM-9550F/FM/L.

Sections include:

- Introduction
- Features
- Specifications
- Board layout and dimensions

## 1.1 Introduction

---

The PCM-9550F/FM/L is an Intel low-power Pentium® MMX™ 266 MHz processor single board computer (SBC) with audio controller, a PCI SVGA controller, a PCI 10/100Base-T Ethernet interface, and one PC/104-*Plus* expansion connector. The PCM-9550F/FM/L's design is based on the EBX form factor that provides support for PC/104 and PC/104-*Plus* module expansion. The EBX form factor also provides a convenient connector layout for easy assembly, more efficient cable connections and better overall embedded system integration. When using an Intel® Pentium® MMX processor, the PCM-9550F/FM/L achieves outstanding performance that surpasses most SBCs in its class. This compact (only 5.75" x 8") unit offers all the functions of a single board industrial computer, but still fits in the space of a 5.25" floppy drive.

On-board features include 512 KB 2nd level cache, four serial ports (three RS-232, one RS-232/422/485), two multi-mode parallel (ECP/EPP/SPP) port, two USB (Universal Serial Bus) ports, a floppy drive controller, and a keyboard/PS/2 mouse interface. The built-in high-speed PCI IDE controller supports both PIO and UDMA/33 bus master modes. Up to two IDE devices can be connected, including large hard disks, CD-ROM drives, and tape backup drives.

The PCM-9550F/FM/L features power management to minimize power consumption. It complies with the "Green Function" standard and supports Doze, Standby and Suspend modes. In addition, the board's watchdog timer can automatically reset the system or generate an interrupt if the system stops due to a program bug or EMI.

### **Highly integrated multimedia SBC**

The PCM-9550F/FM/L is a highly integrated multimedia SBC that combines audio, video, and network functions on a single computer board the size of a 5.25" floppy drive. It provides 16-bit half-duplex, 8-bit full-duplex, integrated 3D audio, and up to

1024 x 768 resolution @ 16.8 M colors with 4 MB display memory. Major on-board devices adopt PCI technology, to achieve outstanding computing performance when used with Intel® Pentium® processors. The PCM-9550F/FM (but not PCM-9550L) also supports TV-out (NTSC/PAL format) and video-in function (PCM-9550FM only) for multimedia applications.

## 1.2 Features

---

- Embedded Intel® low-power Pentium® MMX- 266 MHz processor
- EBX form factor which supports PC/104-*Plus*
- 32-bit PCI-bus SVGA/LCD controller supports 36-bit XGA TFT LCD panels, with up to 1024 x 768 resolution
- Supports dual display function under Windows 98 and Windows 2000
- 100/10Base-T Ethernet interface, IEEE 802.3U compatible
- Supports wake-on-Lan with ATX power supply
- AC97/PCI audio interface (PCM-9550F/PCM-9550FM)
- TV-out and Video capture supports NTSC and PAL formats (PCM-9550FM)
- 4 serial ports (three RS-232 and one RS-232/422/485)
- USB interface complies with USB Rev. 1.10
- 62-level Watchdog timer by system reset or IRQ
- Features system overheat temperature control
- 8-bit TTL digital input, 6-bit TTL digital output and 2 bit high driver digital output. (PCM-9550F/PCM-9550FM)
- 2 IDE channels for HDD and CD-ROM

## 1.3 Specifications

---

### 1.3.1 Standard EBX SBC functions

- **CPU:** Embedded Intel low-power Pentium MMX- 266 MHz
- **BIOS:** AWARD 256KB Flash BIOS, supports Plug & Play, APM, Ethernet boot ROM, boot from CD-ROM, LS-120
- **Chipset:** Intel 430TX
- **Green function:** APM 1.1 compliant
- **2nd level cache:** On-board 512 KB Pipeline Burst SRAM
- **RAM:** One 168-pin DIMM socket accepts 32 ~ 256 MB SDRAM
- **Enhanced IDE interface:** 2 enhanced IDE channels support up to 4 IDE devices.
- **FDD interface:** Supports up to two FDDs (360 KB / 720 KB / 1.2 MB / 1.44 MB / 2.88 MB)
- **On-board security:** Alarms for CPU, overheating and fan failure. Detection of system power voltage, with pop-up monitoring
- **Infrared:** One 4 Mbps fast infrared (FIR) port, IrDA compliant
- **SSD:** Supports CompactFlash cards
- **Parallel port:** Two parallel ports, supporting SPP/EPP/ECP parallel mode (PCM-9550L model supports one parallel port)
- **Serial port:** Four serial ports with three RS-232 (COM1, 3, 4) and one RS-232/422/485 (COM2). All ports with 16C550 compatible UARTs and with +5 V/ +12 V power by jumper select.
- **Watchdog timer:** 62-level interval from 1 to 62 seconds. Generates system reset or IRQ11. Jumperless selection and software enabled/disabled
- **Keyboard/mouse connector:** 8-pin header connector for keyboard and PS/2 mouse

- **USB interface:** Two USB connectors with fuse protection. Compliant with USB Spec. Rev. 1.10
- **I/O bus expansion:** Supports Mini-PCI socket for optional modem
- **PC/104-Plus:** EBX form factor supports PC/104-Plus for ISA and PCI bus expansion. (PCM-9550L Model supports PC/104 only.)

### 1.3.2 PCI SVGA/flat panel interface

- **Chipset:** C&T 69000 with 2 MB memory and optional C&T 69030 with 4 MB memory.
- **Display memory:** 2 MB on-board SDRAM memory, supports up to 4 MB (69030 optional)
- **Display type:** Simultaneously supports CRT and flat panel displays. Also supports 36-bit TFT LCD panels, 64-bit graphics acceleration
- **Display resolution:** Flat panel display up to 800 x 600 @ 24 bpp, 1024 x 768 @ 16 bpp. CRT monitors up to 800 x 600 @ 24 bpp, with 2 MB VGA memory. Also supports CRT monitors up to 1024 x 768 @ 24 bpp, with 4 MB VGA memory
- **Dual display:** available when using 69030 chip only. Supports dual display under Windows 98/Windows Me/ Windows 2000.

### 1.3.3 Digital I/O (PCM-9550F/9550FM only)

- **8 TTL-level digital input control**
- **6 TTL-level digital output control and 2 open collector opto-isolated digital output control or 2 TTL-level digital output control**
- **Isolated output voltage: Open collector 5 to 40 Vdc**
- **Isolated output sink current: 200 mA max.**

### 1.3.4 Audio function (PCM-9550F/9550FM only)

- **Chipset:** ESS ES 1989
- **Audio controller:** AC97 Ver. 2.0 compliant interface, Multistream Direct Sound and Direct Sound 3D acceleration
- **Stereo sound:** 8-bit full-duplex
- **Audio interface:** Microphone in, Line in, CD audio in; Line out, Speaker L, Speaker R
- **Power:** Accepts +12 V source for improved audio quality

### 1.3.5 Video function (PCM-9550FM only)

- **Chipset:** Philips SAA 7111A for Video in; Chromtel CH7002 for TV (Video) out
- **Connectors:** Pin header via optional cable connects to RCA (AV) connector or S-video connector
- **Format:** NTSC or PAL, YUV 422 quality with RGB 16 format. Supports live video capture up to 10 ~ 15 fps at 320 x 240 resolution

### 1.3.6 PCI bus Ethernet interface

- **Chipset:** REALTEK RTL8139 Ethernet controller
- **Ethernet interface:** IEEE 802.3U compatible 100/10Base-T interface. Includes software drivers and boot ROM
- **Wake-on-Lan:** Supports wake-on-Lan function with ATX power control

### 1.3.7 Mechanical and environmental

- **Max. power requirements:** 3 A @ 5 V (4.75 V ~ 5.25 V)  
Standard consumption 2 A @ 5 V with Intel low-power Pentium® MMX-266 processor, 64 MB DIMM

- **Operating temperature:** 0 ~ 60° C (32 ~ 140° F)
- **Size (L x W):** 203 mm x 146 mm (8" x 5.75")
- **Weight:** 0.7 kg (1.54 lb) (weight of total package)

## 1.4 Board layout and dimensions

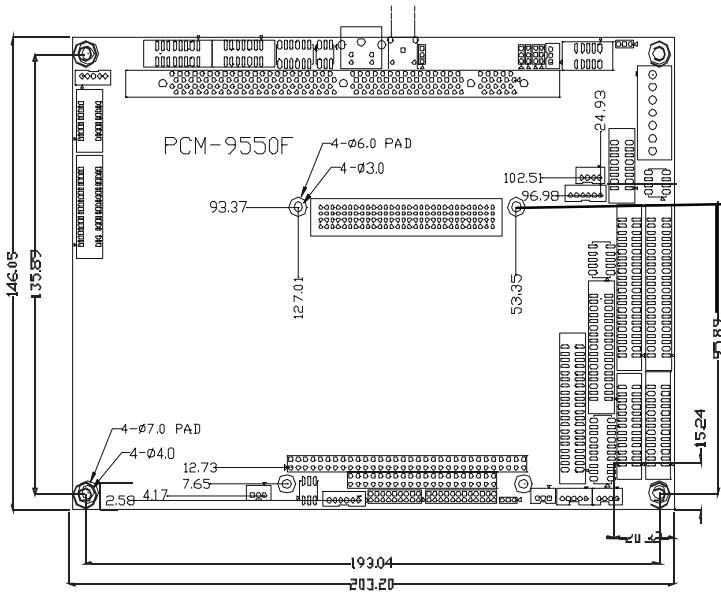

Figure 1-1: PCM-9550 dimensions



# CHAPTER 2

## Installation

This chapter tells how to set up the PCM-9550F/FM/L hardware. It includes instructions on setting jumpers, and connecting peripherals, switches and indicators. Be sure to read all the safety precautions before you begin the installation procedure.

## 2.1 Jumpers

---

The PCM-9550F/FM/L has a number of jumpers that allow you to configure your system to suit your application. The table below lists the function of each of the board's jumpers.

Table 2-1: Jumpers

<b>Label</b>	<b>Function</b>
J1	VGA/TV out function select
J2	TV out format select (PCM-9550FM only)
J3	CMOS clear
J4	ATX power on function select
J5	Reserve
J6	LAN controller power select
J7	Audio power source setting (PCM-9550F/9550FM only)
J8	DOC 2000 address setting
J9	COM2 RS-232/422/485 setting
J10	COM port RI pin setting
J11	Watchdog timer action

## 2.2 Connectors

---

On-board connectors link the PCM-9550F/FM/L to external devices such as hard disk drives, a keyboard, or floppy drives. The table below lists the function of each of the board's connectors.

Table 2-2: Connector Assignments

<b>Label</b>	<b>Function</b>
CN1	CRT display connector
CN2	Video in/video out connector*
CN3	Reserve for S-video connector*
CN4	Reserve for composite connector*
CN5	ATX feature connector
CN6	Ethernet connector
CN7	Backlight connector
CN8	Main power connector
CN 9	Ext. flat panel display connector
CN10	Keyboard and PS/2 mouse connector
CN11	CD Audio input connector**
CN12	Audio connector**
CN13	Front panel connector
CN14	Flat panel connector
CN15	USB channel 1,2 connector
CN16	IDE hard drive connector (secondary)
CN17	IDE hard drive connector (primary)
CN18	PC/104 plus (ISA + PCI) expansion
CN19	Floppy drive connector
CN20	COM-port connector
CN21	Parallel port connector (LPT2)**
CN22	Parallel port connector (LPT1)
CN23	8 Digital I/O
CN24	Fan power connector
CN25	Reserve for WDT PLD programing
CN26	Peripheral power connector
CN27	IR connector
CN28	2 Digital output (opto isolated)
CN29	Mini PCI connector**
CN30	CFC connector **

\* PCM-9550FM only

\*\* PCM-9550FM and PCM-9550F only

## 2.3 Locating jumpers

---

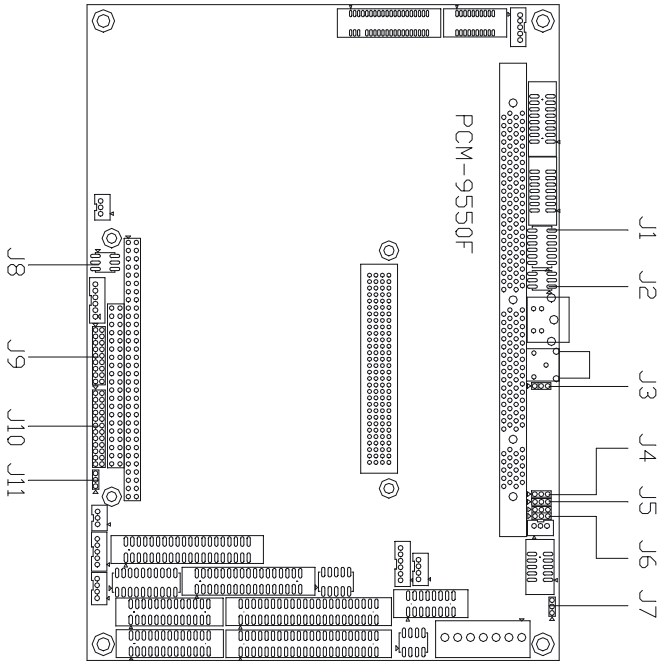

Figure 2-1: Locating jumpers

## 2.4 Locating connectors

### 2.4.1 Component side

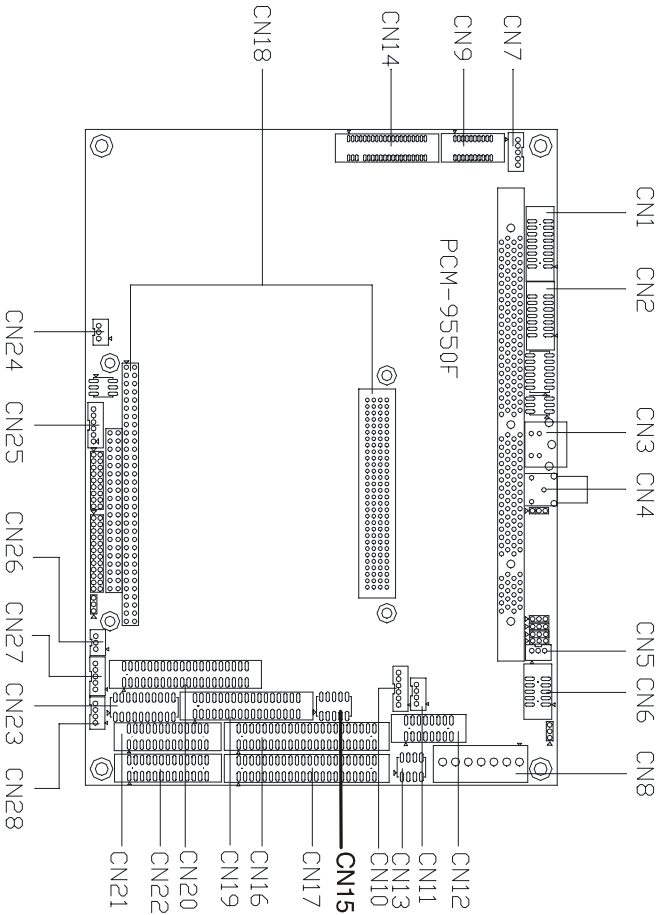

Figure 2-2: Locating connectors (component side)

## 2.4.2 Solder side

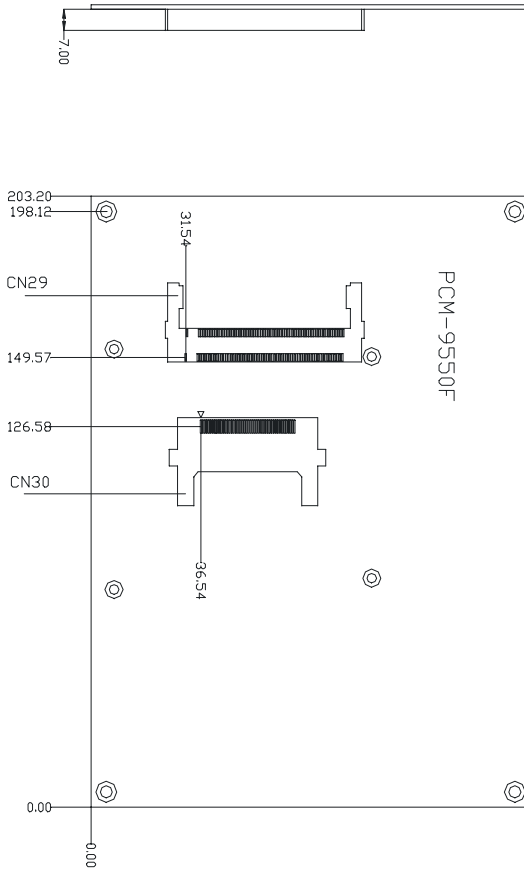
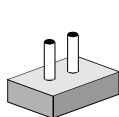

Figure 2-3: Locating connectors (solder side)

## 2.5 Setting jumpers

You configure your card to match the needs of your application by setting jumpers. A jumper is the simplest kind of electric switch. It consists of two metal pins and a small metal clip (often protected by a plastic cover) that slides over the pins to connect them. To “close” a jumper, connect the pins with the clip. To “open” a jumper, remove the clip. Sometimes a jumper will have three pins, labeled 1, 2, and 3. In this case, you would connect either pins 1 and 2 or 2 and 3.



*Open*

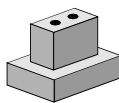

*Closed*

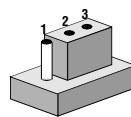

*Closed 2-3*

The jumper settings are schematically depicted in this manual as follows:



*Open*



*Closed*



*Closed 2-3*

A pair of needle-nose pliers may be helpful when working with jumpers.

If you have any doubts about the best hardware configuration for your application, contact your local distributor or sales representative before you make any changes.

Generally, you simply need a standard cable to make most connections.

## 2.6 CMOS clear (J3)

*Warning: To avoid damaging the computer, always turn off the power supply before setting "Clear CMOS." Before turning on the power supply, set the jumper back to "3.0 V Battery On."*

---

Table 2-3: CMOS clear (J3)

---

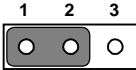
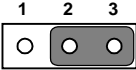
	<b>*3.0 V Battery on</b>	<b>Clear CMOS</b>
J3		

---

\* default setting

## 2.7 Installing system memory (DIMMs)

---

You are able to install memory ranging from 16 to 256 MB of DIMM onto your PCM-9550F/FM/L card. The card provides one 168-pin DIMM socket, which accepts 16, 32, 64, 128 or 256 MB 3.3 V power level EDO/synchronous DIMMs.

### 2.7.1 Installing DIMMs

The procedure for installing DIMMs is described below. Please follow these steps carefully. The number of pins are different on either side of the breaks, so the module can only fit in one way. DIMM modules have different pin contacts on each side, and therefore have a higher pin density.

1. Make sure that the two handles of the DIMM socket are in the “open” position. i.e. The handles remain leaning outward.
2. Slowly slide the DIMM module along the plastic guides on both ends of the socket.
3. Press the DIMM module right down into the socket, until you hear a click. This is when the two handles have automatically locked the memory module into the correct position of the socket.

To remove the memory module, just push both handles outward, and the module will be ejected from the socket.

## 2.8 IDE, CDROM hard drive connector (CN16, CN17)

---

The PCM-9550F/FM/L provides 2 IDE channels which you can attach up to four Enhanced Integrated Device Electronics hard disk drives or CDROM to the PCM-9550F/FM/L’s internal controller. The PCM-9550F/FM/L’s IDE controller uses a PCI interface. This advanced IDE controller supports faster data transfer, PID mode 3, mode 4 and UDMA/33.

## 2.8.1 Connecting the hard drive

Connecting drives is done in a daisy-chain fashion. It requires one of two cables (not included in this package), depending on the drive size. 1.8" and 2.5" drives need a 1 x 44-pin to 2 x 44-pin flat-cable connector. 3.5" drives use a 1 x 44-pin to 2 x 40-pin connector.

Wire number 1 on the cable is red or blue, and the other wires are gray.

1. Connect one end of the cable to CN16 or CN17. Make sure that the red (or blue) wire corresponds to pin 1 on the connector, which is labeled on the board (on the right side).
2. Plug the other end of the cable into the Enhanced IDE hard drive, with pin 1 on the cable corresponding to pin 1 on the hard drive. (See your hard drive's documentation for the location of the connector.)

Connect a second drive as described above.

Unlike floppy drives, IDE hard drives can connect to either end of the cable. If you install two drives, you will need to set one as the master and one as the slave by using jumpers on the drives. If you install just one drive, set it as the master.

## 2.9 Solid State Disk

---

The PCM-9550F/FM/L provides a CompactFlash™ card socket and DiskOnChip socket for Solid state disk solutions.

### 2.9.1 CompactFlash (CN30)

The CompactFlash card shares a secondary IDE channel which can be enabled/disabled via the Bios settings.

### 2.9.2 DiskOnChip 2000 Address setting (J8)

The DiskOnChip address can be set using the table below.

---

Table2-4: J8: DOC-2000 address setting

---

<b>1-2</b>	<b>3-4</b>	<b>5-6</b>	<b>setting</b>
closed	closed	closed	C800
closed	closed	open	CC00
closed	open	closed	D000*
closed	open	open	D400
open	closed	closed	D800
open	closed	open	DC00
open	open	closed	E000
open	open	open	Off

---

## 2.10 Floppy drive connector (CN19)

---

You can attach up to two floppy drives to the PCM-9550F/FM/L's on-board controller. You can use any combination of 5.25" (360 KB and 1.2 MB) and/or 3.5" (720 KB, 1.44 MB, and 2.88 MB) drives.

A 34-pin daisy-chain drive connector cable is required for a dual-drive system. On one end of the cable is a 34-pin flat-cable connector. On the other end are two sets of floppy disk drive connectors. Each set consists of a 34-pin flat-cable connector (usually used for 3.5" drives) and a printed-circuit board connector (usually used for 5.25" drives).

### 2.10.1 Connecting the floppy drive

1. Plug the 34-pin flat-cable connector into CN19. Make sure that the red wire corresponds to pin one on the connector.
2. Attach the appropriate connector on the other end of the cable to the floppy drive(s). You can use only one connector in the set. The set on the end (after the twist in the cable) connects to the A: drive. The set in the middle connects to the B: drive.
3. If you are connecting a 5.25" floppy drive, line up the slot in the printed circuit board with the blocked-off part of the cable connector.

If you are connecting a 3.5" floppy drive, you may have trouble determining which pin is number one. Look for a number printed on the circuit board indicating pin number one. In addition, the connector on the floppy drive may have a slot. When the slot is up, pin number one should be on the right. Check the documentation that came with the drive for more information.

If you desire, connect the B: drive to the connectors in the middle of the cable as described above.

In case you need to make your own cable, you can find the pin assignments for the board's connector in Appendix C.

## 2.11 Parallel port connector (CN21, CN22)

---

Normally, the parallel port is used to connect the card to a printer. The PCM-9550F/FM/L includes a multi-mode (ECP/EPP/SPP) parallel port accessed via CN21 or CN22, and a 26-pin flat-cable connector. You will need an adapter cable if you use a traditional DB-25 connector. The adapter cable has a 26-pin connector on one end, and a DB-25 connector on the other.

The parallel port is designated as LPT1, and can be disabled or changed to LPT2 or LPT3 in the system BIOS setup.

The parallel port interrupt channel is designated to be IRQ7.

You can select ECP/EPP DMA channel via BIOS setup.

## 2.12 Keyboard and PS/2 mouse connector (CN10)

---

The PCM-9550F/FM/L board provides a keyboard connector that supports both a keyboard and a PS/2 style mouse. In most cases, especially in embedded applications, a keyboard is not used. If the keyboard is not present, the standard PC/AT BIOS will report an error or fail during power-on self-test (POST) after a reset. The PCM-9550F/FM/L's BIOS standard setup menu allows you to select "All, But Keyboard" under the "Halt On" selection. This allows no-keyboard operation in embedded system applications, without the system halting under POST.

## 2.13 Front panel connector (CN13)

---

Next, you may want to install external switches to monitor and control the PCM-9550F/FM/L. These features are optional: install them only if you need them. The front panel connector (CN13) is an 8-pin male, dual in-line header. It provides connections for a speaker, hard disk access indicator, watchdog output, and an input switch for resetting the card.

### 2.13.1 Speaker

The PCM-9550F/FM/L can drive an 8 ohm speaker at 0.5 watts. Make sure that alternatives to this specification do not overload the card.

### 2.13.2 LED interface

The front panel LED indicator for hard disk access is an active low signal (24 mA sink rate).

### 2.13.3 Watchdog output

When the PCM-5864/L's watchdog timer times out, the front panel pin 6 will output an active low pulse signal (25mA sink rate for 1 second).

### 2.13.4 Reset switch

If you install a reset switch, it should be an open single pole switch. Momentarily pressing the switch will activate a reset. The switch should be rated for 10 mA, 5 V.

If you need to make your own cable, you can find the pin assignments for the board's connector in Appendix C.

## 2.14 Power connectors (CN24, CN8, CN26)

---

### 2.14.1 Peripheral power connector, -5 V, -12 V (CN26)

Supplies secondary power to devices that require -5 V and -12 V.

### 2.14.2 Main power connector, +5 V, +12 V (CN8)

Supplies main power to the PCM-5864/L (+5 V), and to devices that require +12 V.

### 2.14.3 CPU Fan power supply connector (CN24)

Provides power supply to CPU cooling fan. Only present when +5 V and +12 V power is supplied to the board.

## 2.15 ATX power control connector (J4, CN5)

### 2.15.1 ATX feature connector (CN5) and soft power switch connector (J4)

The PCM-9550F/FM/L can support an advanced soft power switch function, if an ATX power supply is used. To enable the soft power switch function:

1. Get the specially designed ATX-to-EBX power cable (PCM-9550F/FM/L optional item, part no. 1703200100)
2. Connect the 3-pin plug of the cable to CN5 (ATX feature connector).
3. Connect the power on/off button to J4. (A momentary button switch should be used.)

*Important: Make sure that the ATX power supply can take at least a 10 mA load on the 5 V standby lead (5VSB). If not, you may have difficulty powering on your system.*

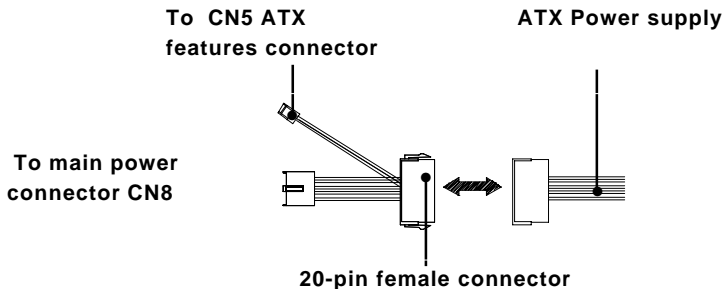

Figure 2-4: Wiring for ATX soft power switch function

## 2.16 IR connector (CN27)

---

This connector supports the optional wireless infrared transmitting and receiving module. This module mounts on the system case. You must configure the setting through BIOS setup.

## 2.17 Audio interfaces (CN2, CN11) (PCM-9550F/9550FM only)

---

The PCM-9550F/FM is equipped with a high-quality audio interface, which provides 16-bit CD-quality recording and playback as well as OPL3 compatible FM music. It is supported by all major operating systems.

### 2.17.1 Audio connector (CN12)

The PCM-9550F/FM provides all major audio signals on a 16-pin flat-cable connector, CN4. These audio signals include Microphone in (mono), Line in (stereo), Line out (stereo), and Speaker out (stereo). If you use traditional telephone jack connectors for these audio signals, you will need an adapter cable.

### 2.17.2 CD audio input connector (CN11)

Any CD-ROM drive can provide analog audio signal output when used as a music CD player. The CN11 on PCM-9550F/FM is a connector to input CD audio signals into the audio controller. The audio cable of your CD-ROM drive will be used to connect to CN11.

### 2.17.3 Audio power source setting (J7)

The PCM-9550F/FM is designed to work with a single +5 V power supply. The audio interface can also function normally under single +5V power supply, but most audio controllers require an independent power source generated from a +12 V power supply. The independent power source avoids the noise from the other digital circuits. The PCM-9550F/FM's audio interface can accept +12 V power to provide improved quality audio. This is done via J7.

Table 2-5: Audio power source setting

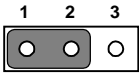
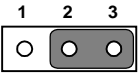
	*+5 V	+12 V
J7		

\* default setting

Configuration of the audio interface is done entirely via the software utility. You do not have to set any jumpers. Refer to Chapter 6 for audio setup details.

## 2.18 COM port connector (CN20)

---

The PCM-9550F/FM/L provides four serial ports (COM1, 3, 4: RS-232; COM2: RS-232/422/485) in one COM port connector. The COM port connector is a 40-pin, dual-inline, male header. It provides connections for serial devices (a mouse, etc.) or a communication network. You can find the pin assignments for the COM port connector in Appendix C.

### 2.18.1 COM2 RS-232/422/485 setting (J9)

COM2 can be configured to operate in RS-232, RS-422, or RS-485 mode. This is done via J9.

---

Table 2-6: J9: COM2 RS-232/422/485 select

---

	<b>RS-232*</b>	<b>RS-422</b>	<b>RS-485</b>
<b>1-2</b>	<b>Open</b>	<b>Open</b>	<b>Closed</b>
<b>3-4</b>	<b>Open</b>	<b>Closed</b>	<b>Open</b>
<b>5-6</b>	<b>Closed</b>	<b>Open</b>	<b>Open</b>
<b>7-9</b>	<b>Closed</b>	<b>Open</b>	<b>Open</b>
<b>8-10</b>	<b>Closed</b>	<b>Open</b>	<b>Open</b>
<b>9-11</b>	<b>Open</b>	<b>Closed</b>	<b>Closed</b>
<b>10-12</b>	<b>Open</b>	<b>Closed</b>	<b>Closed</b>
<b>13-15</b>	<b>Closed</b>	<b>Open</b>	<b>Open</b>
<b>14-16</b>	<b>Closed</b>	<b>Open</b>	<b>Open</b>
<b>15-17</b>	<b>Open</b>	<b>Closed</b>	<b>Closed</b>
<b>16-18</b>	<b>Open</b>	<b>Closed</b>	<b>Closed</b>

---

### 2.18.2 Share IRQ (PCM-9550F/9550FM only)

The IRQ and the address range for COM1, 2, 3, 4 default are fixed. However, if you wish to disable the port or change these parameters later, you can do this in the system BIOS setup. The table below shows the settings for the PCM-9550F/FM's serial ports.

Table 2-7: Serial port default settings

Port	Address range	Interrupt
COM1	3F8 ~ 3FF	IRQ4
COM2	2F8 ~ 2FF	IRQ3
COM3	3E8 ~ 3EF	IRQ10
COM4	2E8 ~ 2EF	IRQ5

COM1-4 can share one IRQ that can be selected by BIOS setup for IRQ3, IRQ4, IRQ5 or IRQ10 under Windows 98 and Windows NT.

### 2.18.3 COM port RI pin setting (J10)

COM1 to COM4 can supply +5 V or +12 V power to the serial devices via the RI pin of the COM port connector. The outputs of the COM3 and COM4 RI pins are selected by setting J10.

Table 2-8: J10: COM1-4 RI settings

<b>Pins</b>	<b>Com port</b>	<b>RI pin</b>	<b>Power setting</b>
1-2	COM1	RI pin	+5 V
3-4	COM1	RI pin	+12 V
5-6	COM1	RI pin	R I*
7-8	COM2	RI pin	+5 V
9-10	COM2	RI pin	+12 V
11-12	COM2	RI pin	R I*
13-14	COM3	RI pin	+5 V
15-16	COM3	RI pin	+12 V
17-18	COM3	RI pin	R I*
19-20	COM4	RI pin	+5 V
21-22	COM4	RI pin	+12 V
23-24	COM4	RI pin	R I*

## 2.19 VGA interface connections

---

The PCM-5864/L's PCI SVGA interface can drive conventional CRT displays and is capable of driving a wide range of flat panel displays, including electroluminescent (EL), gas plasma, passive LCD and active LCD displays. The board has two connectors to support these displays, one for standard CRT VGA monitors and one for flat panel displays.

### 2.19.1 CRT display connector (CN1)

CN1 is a 16-pin, dual-inline header used for conventional CRT displays. A simple one-to-one adapter can be used to match CN1 to a standard 15-pin D-SUB connector commonly used for VGA.

Pin assignments for CRT display connector CN18 are detailed in Appendix C.

### 2.19.2 Flat panel display connector (CN14)

CN14 consists of a 40-pin connector which can support a 24-bit LCD panel. It is Hirose's product no. DF13A-40DP-1.25 V

The PCM-9550F/FM/L provides a bias control signal on CN14 that can be used to control the LCD bias voltage. It is recommended that the LCD bias voltage not be applied to the panel until the logic supply voltage (+5 V or +3.3 V) and panel video signals are stable. Under normal operation, the control signal (ENAVEE) is active high. When the PCM-9550F/FM/L's power is applied, the control signal is low until just after the relevant flat panel signals are present.

### 2.19.3 Extension flat panel connector (CN9)

CN9 consists of a 20-pin connector which is Hirose's product no. DF13A-20DP-1.25V. The PCM-9550F/FM/L supports a 36-bit LCD panel which must be connected to both the CN14 (40-pin) and the CN9 (20-pin). The pin assignments for both CN14 and the CN9 can be found in Appendix C.













## 2.19.4 LCD power setting

The PCM-9550F/FM/L's PCI SVGA interface supports 5 V and 3.3 V LCD displays that provide  $V_{dd}$  5 V signal on CN14.

## 2.20 VGA/TV-Out function select (J1)

The PCM-9550F/FM provides a TV-out function that is selected by configuring J1 as shown below.

Table 2-9: VGA/TV-Out function select (J1)

VGA						TV					
11	9	7	5	3	1	11	9	7	5	3	1
											
12	10	8	6	4	2	12	10	8	6	4	2

## 2.21 Video In/Out interfaces (CN2) (PCM-9550FM only)

The PCM-9550FM board provides Video-in and Video-out (TV-out) (CN2). They consist of a 14-pin dual-inline header respectively. Video capture supports RCA and S-video connectors via an optional cable kit. Its Video-in and Video-out generators use both NTSC and PAL format.

To set up your video interface:

1. Set J2 according to whether you want NTSC or PAL format. See Table 2-10 below.

- Run the appropriate installation software program, located in the utility disk.

For NTSC format, the file is **55xntsc.exe**, located in:  
**Biscuit\9550F\Video.100\69000\TV-out\**

For PAL format, the file is **55xpal.exe**, located in:  
**Biscuit\9550F\Video.100\69000\TV-out\**

Table 2-10: J2 TV out format select

1-2	3-4	5-6	resolution	TV-out	function
closed	closed	closed	800*600	PAL	underscan
closed	closed	open	640*480	PAL	underscan
closed	open	closed	640*480	NTSC	overscan*
closed	open	open	640*480	NTSC	underscan
open	closed	closed	640*480	PAL	overscan
open	closed	open	800*600	PAL	overscan
open	open	closed	800*600	NTSC	undeerscan
open	open	open	reserved	N/A	N/A

\* default setting

## 2.22 Ethernet configuration

The PCM-9550F/FM/L is equipped with a high performance 32-bit PCI-bus Ethernet interface which is fully compliant with IEEE 802.3U 10/100Mbps CSMA/CD standards. It is supported by all major network operating systems.

The medium type can be configured via the RSET8139.EXE program included on the utility disk. (See Chapter 3 for detailed information.)

### 2.22.1 100Base-T connector (CN16)

10/100Base-T connects to the PCM-9550F/FM/L via an adapter cable to a 10-pin polarized header (CN6).

### 2.22.2 Network boot

The Network Boot feature can be utilized by incorporating the Boot ROM image files for the appropriate network operating system. The Boot ROM BIOS files are included in the system BIOS, which is on the utility CD disc.

### 2.22.3 LAN controller power select (J6)

Table 2-11: LAN controller power select (J6)



\* default setting

*Note:* PCM-9550F/FM/L supports Wake-on-LAN. For Wake-on LAN, J6 has to be set to the Standby 3.3 V (2-3) position

## 2.23 Watchdog timer configuration

An on-board watchdog timer reduces the chance of disruptions which EMP (electro-magnetic pulse) interference can cause. This is an invaluable protective device for standalone or unmanned applications. Setup involves one jumper and running the control software (refer to Appendix A).

### 2.23.1 Watchdog timer action (J11)

When the watchdog timer activates (CPU processing has come to a halt), it can reset the system or generate an interrupt on IRQ11. This can be set via setting J11 as shown below:

Table 2-12: Watchdog timer action (J11)

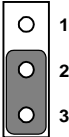
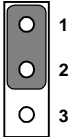
	*System reset	IRQ11
J11		

\* default setting

## 2.24 USB connectors (CN15)

The PCM-9550F/FM/L board provides two USB (Universal Serial Bus) ports which gives complete plug and play, and hot attach/detach for up to 127 external devices. The USB interfaces comply with USB specification Rev. 1.0, and are fuse protected.

The USB interface is accessed through one 5-pin flat-cable connector, CN15. You will need an adapter cable if you use a standard USB connector. The adapter cable has a 5-pin connector on one end and an USB connector on the other.

The USB interfaces can be disabled in the system BIOS setup.

## 2.25 Digital I/O (CN23, CN28: 8 Outputs, 8 Inputs) (PCM-9550F/9550FM only)

The PCM-9550F/FM/L has eight digital outputs and eight digital inputs (TTL level). The digital outputs support 8 TTL level or 2 opto-isolated open collector and 6 TTL level output. You can configure the digital I/O to control the opening of the cash drawer and to sense the closing of the cash drawer. The following shows how the digital I/O is controlled via software programming.

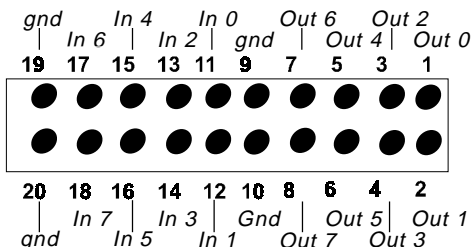

Figure 2-5: CN 23 Digital Input/Output

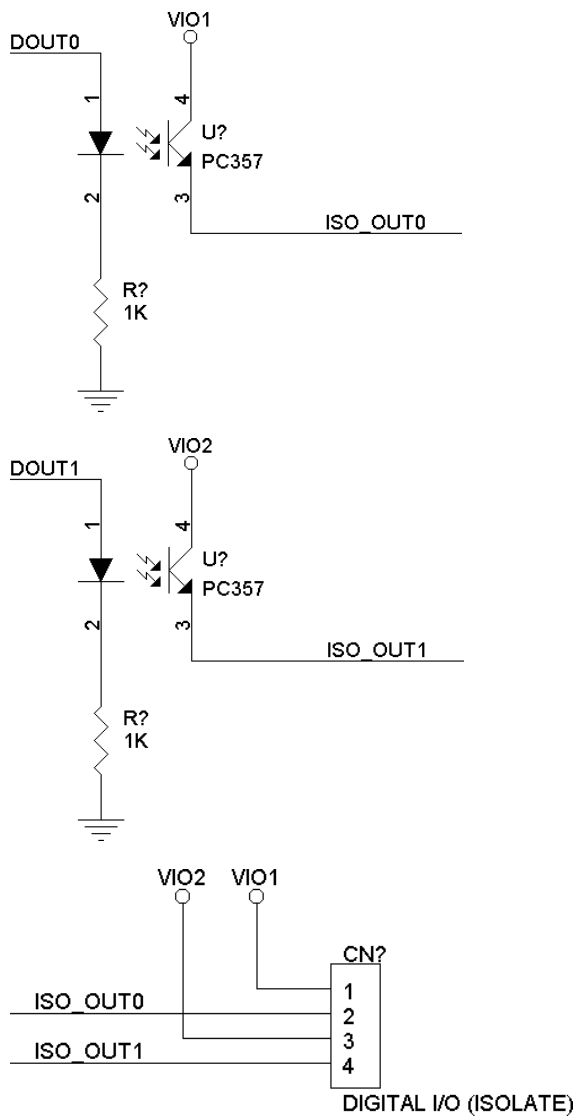

Figure 2-6: Digital opto Isolated output block diagram

## 2.25.1 Digital output programming

Table 2-13: Digital output programming

<b>Output</b>	<b>Address</b>	<b>Bit</b>
Out 0	550	0
Out 1	550	1
Out 2	550	2
Out 3	550	3
Out 4	550	4
Out 5	550	5
Out 6	550	6
Out 7	550	7

## 2.25.2 Digital Input programming

Table 2-14: Digital input programming

<b>Input</b>	<b>Address</b>	<b>Bit</b>
In-0	550	0
In-1	550	1
In-2	550	2
In-3	550	3
In-4	550	4
In-5	550	5
In-6	550	6
In-7	550	7

*Note: The INPUT signal must be TTL compatible.*

### 2.25.3 Isolated Digital Output (CN28)

The PCM-9550F supports 2 isolated digital output via CN28. The pin assignment as follows:

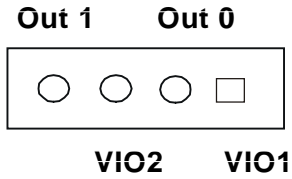

*Figure 2-7: CN28 Isolated Digital Output*

## Software Configuration

This chapter details the software configuration information. It shows you how to configure the card to match your application requirements. AWARD System BIOS is covered in Chapter 4.

Sections include:

- Introduction
- Connections for four standard LCDs
- Ethernet interface configuration

## 3.1 Introduction

---

The PCM-9550F/FM/L system BIOS and custom drivers are located in a 256 Kbyte, Flash ROM device, designated U18. A single Flash chip holds the system BIOS, VGA BIOS and network Boot ROM image. The display can be configured via CMOS settings. This method minimizes the number of chips and difficulty of configuration. To set different types of LCD panels, please choose “panel type” from the “integrated peripherals” menu in CMOS setup.

## 3.2 Connections for five standard LCDs

---

### 3.2.1 Connections to Sharp LM64183P, LM64P89 (640 x 480 DSTN MONO LCD)

Table 3-1: Connections to Sharp LM64183P & LM64P89

LM64183/64P89		PCM-9550F/FM CN14	
Pin	Name	Pin	Name
CN1-1	S	36	FLM
CN1-2	CP1	38	LP
CN1-3	CP2	35	SHFCLK
CN1-4	DISP	5	+5 V
CN1-5	VDD	6	+5 V
CN1-6	VSS	3	GND
CN1-7	VEE	-	External power*
CN1-8	DU0	12	P3
CN1-9	DU1	11	P2
CN1-10	DU2	10	P1
CN1-11	DU3	9	P0
CN1-12	DL0	16	P7
CN1-13	DL1	15	P6
CN1-14	DL2	14	P5
CN1-15	DL3	13	P4

\* LM64183P -17 V                      LM64P89 -20 V

**Note:**            *Standard BIOS supports TFT and DSTN LCD panels.*

### 3.2.2 Connections to PLANAR EL (640 x 480 AD4 EL)

Table 3-2: Connections to PLANAR EL

<b>PLANAR 640 x 480 AD4 Pin</b>	<b>Name</b>	<b>PCM-9550F/FM CN14 Pin</b>	<b>Name</b>
1	GND	3	GND
2	D0	21	P12
3	GND	3	GND
4	D1	22	P13
5	GND	3	GND
6	D2	23	P14
7	NC	—	—
8	D3	24	P15
9	NC	—	—
10	D4	17	P8
11	NC	—	—
12	D5	18	P9
13	NC	—	—
14	D6	19	P10
15	GND	4	GND
16	D7	20	P11
17	GND	4	GND
18	VCLK	42	ASHFCLK
19	GND	4	GND
20	/BLANK	—	—
21	GND	8	GND
22	HS	37	M
23	NC	—	—
24	VS	36	FLM
25	NC	—	—
26	SELFTST	39	GND
27	COLMAP	39	GND
28	ENABLE	—	—
29	RESERVED	—	—
30	/LOWPOW	—	—
31,32	NC	—	—
33	RESERVED	—	—
34	NC	—	—

### 3.2.3 Connections to Toshiba LTM10C042 (640 x 480 TFT color LCD)

Table 3-3: Connections to Toshiba LTM10DC042

LTM10C042		PCM-9550F/FM CN14	
Pin	Name	Pin	Name
1	GND	3	GND
2	CLK	35	SHFCLK
3	GND	4	GND
4	R0	27	P18
5	R1	28	P19
6	R2	29	P20
7	GND	8	GND
8	R3	30	P21
9	R4	31	P22
10	R5	32	P23
11	GND	33	GND
12	G0	19	P10
13	G1	20	P11
14	G2	21	P12
15	GND	33	GND
16	G3	22	P13
17	G4	23	P14
18	G5	24	P15
19	GND	34	GND
20	ENAB	37	M
21	GND	34	GND
22	B0	11	P2
23	B1	12	P3
24	B2	13	P4
25	GND	39	GND
26	B3	14	P5
27	B4	15	P6
28	B5	16	P7
29	GND	39	GND
30	VDD	5	+5 V
31,32	VDD	6	+5 V

### 3.2.4 Connections to Sharp LM64C142 (640 x 480 DSTN color LCD)

Table 3-4: Connections to Sharp LM64C142

<b>LM64C142</b>		<b>PCM-9550F/FM CN14</b>	
<b>Pin</b>	<b>Name</b>	<b>Pin</b>	<b>Name</b>
CN1-1	YD	36	FLM
CN1-2	LP	38	LP
CN1-3	XCX	35	SHFCLK
CN1-4	DISP	5	+5 V
CN1-5	VDD	6	+5 V
CN1-6	VSS	3	GND
CN1-7	VEE	—	+27*
CN1-8	DU0	20	P11
CN1-9	DU1	19	P10
CN1-10	DU2	18	P9
CN1-11	DU3	17	P8
CN1-12	DU4	12	P3
CN1-13	DU5	11	P2
CN1-14	DU6	10	P1
CN1-15	DU7	9	P0
CN2-1	VSS	4	GND
CN2-2	DL0	24	P15
CN2-3	DL1	23	P14
CN2-4	DL2	22	P13
CN2-5	DL3	21	P12
CN2-6	DL4	16	P7
CN2-7	DL5	15	P6
CN2-8	DL6	14	P5
CN2-9	DL7	13	P4
CN2-10	VSS	8	GND

### 3.2.5 Connections to Toshiba LTM12C275A (800 x 600 TFT color LCD)

Table 3-5: Connections to Toshiba LTM12C2775A

LTM12C275A		PCM-9550F/FM CN14	
Pin	Name	Pin	Name
1	GND	3	GND
2	NCLK	35	SHFCLK
3	NC	-	NC
4	NC	-	NC
5	GND	4	GND
6	R0	27	P18
7	R1	28	P19
8	R2	29	P20
9	R3	30	P21
10	R4	31	P22
11	R5	32	P23
12	GND	8	GND
13	G0	19	P10
14	G1	20	P11
15	G2	21	P12
16	G3	22	P13
17	G4	23	P14
18	G5	24	P15
19	GND	33	GND
20	B0	11	P2
21	B1	12	P3
22	B2	13	P4
23	B3	14	P5
24	B4	15	P6
25	B5	16	P7
26	ENAB	37	M/DE
27	GND	34	GND
28	VCC	5	+5 V
29	VCC	6	+5 V
30	GND	39	GND

### 3.3 Ethernet software configuration

---

The PCM-9550F/FM/L's on-board Ethernet interface supports all major network operating systems. To configure the medium type, to view the current configuration, or to run diagnostics, do the following:

1. Power the PCM-9550F/FM/L on. Make sure that the RSET8139.EXE file is located in the working drive.
2. At the prompt, type RSET8139.EXE and press <Enter>. The Ethernet configuration program will then be displayed.
3. This simple screen shows all the available options for the Ethernet interface. Just highlight the option you wish to change by using the Up and Down keys. To change a selected item, press <Enter>, and a screen will appear with the available options. Highlight your option and press <Enter>. Each highlighted option has a helpful message guide displayed at the bottom of the screen for additional information.
4. After you have made your selections and are sure this is the configuration you want, press ESC. A prompt will appear asking if you want to save the configuration. Press Y if you want to save.

The Ethernet Setup Menu also offers three very useful diagnostic functions. These are:

1. Run EEPROM Test
2. Run Diagnostics on Board
3. Run Diagnostics on Network

Each option has its own display screen that shows the format and result of any diagnostic tests undertaken.

*Note:* For Ethernet installation, please see Chapter 8.



# CHAPTER 4

## Award BIOS Setup

This chapter describes how to set BIOS configuration data.

## 4.1 System test and initialization

---

These routines test and initialize board hardware. If the routines encounter an error during the tests, you will either hear a few short beeps or see an error message on the screen. There are two kinds of errors: fatal and non-fatal. With non-fatal errors, the system can usually continue the boot sequence. Non-fatal error messages usually appear on the screen along with the following instructions:

```
press <F1> to RESUME
```

Write down the message and press the F1 key to continue the boot sequence.

### 4.1.1 System configuration verification

These routines check the current system configuration against the values stored in the board's CMOS memory. If they do not match, the program outputs an error message. You will then need to run the BIOS setup program to set the configuration information in memory.

There are three situations in which you will need to change the CMOS settings:

1. You are starting your system for the first time
2. You have changed the hardware attached to your system
3. The CMOS memory has lost power and the configuration information has been erased.

The PCM-9550F/FM/L's CMOS memory has an integral lithium battery backup. The battery backup should last ten years in normal service. When it finally runs down, you will need to replace the complete unit.

## 4.2 AWARD BIOS setup

Award's BIOS ROM has a built-in Setup program that allows users to modify the basic system configuration. This type of information is stored in battery-backed CMOS RAM, so that it retains the Setup information when the power is turned off.

### 4.2.1 Entering setup

Power on the computer and press <Del> immediately. This will allow you to enter Setup.

```
ROM PCI/ISA BIOS (2A59IAKG)
CMOS SETUP UTILITY
AWARD SOFTWARE, INC.
```

STANDARD CMOS SETUP	INTEGRATED PERIPHERALS
BIOS FEATURES SETUP	PASSWORD SETTING
CHIPSET FEATURES SETUP	IDE HDD AUTO DETECTION
POWER MANAGEMENT SETUP	SAVE & EXIT SETUP
PNP/PCI CONFIGURATION	EXIT WITHOUT SAVING
LOAD BIOS DEFAULTS	
LOAD SETUP DEFAULTS	
Esc : Quit	↑ ↓ → ← : Select Item
F10 : Save & Exit Setup	(Shift)F2 : Change Color

Figure 4-1: Setup program initial screen

## 4.2.2 Standard CMOS setup

When you choose the STANDARD CMOS SETUP option from the INITIAL SETUP SCREEN menu, the screen shown below is displayed. This standard Setup menu allows users to configure system components such as date, time, hard disk drive, floppy drive and display. Once a field is highlighted, online help information is displayed at the bottom left of the Menu screen.

```
ROM PCI/ISA BIOS (2A59IAKA)
STANDARD CMOS SETUP
AWARD SOFTWARE, INC.
```

Date (mm:dd:yy) : Tue, Jan 26 1999								
Time (hh:mm:ss) : 13 : 22 : 35								
HARD DISKS	TYPE	SIZE	CYLS	HEAD	PRECOMP	LANDZ	SECTOR	MODE
Primary Master	:	0	0	0	0	0	0	0 NORMAL
Primary Slave	:	0	0	0	0	0	0	0 NORMAL
Secondary Master	:	0	0	0	0	0	0	0 NORMAL
Secondary Slave	:	0	0	0	0	0	0	0 NORMAL
Drive A : None								
Drive B : None								
Video : EGA/VGA								
Halt On : All Errors								
ESC : Quit			↑ ↓ → ← : Select Item			PU/PD/+/- : Modify		
F1 : Help			(Shift)F2 : Change Color					

Figure 4-2: CMOS setup screen

### 4.2.3 BIOS features setup

By choosing the BIOS FEATURES SETUP option from the INITIAL SETUP SCREEN menu, the screen below is displayed. This sample screen contains the manufacturer's default values for the PCM-9550F/FM/L.

```
ROM PCI/ISA BIOS (2A59IAKA)
BIOS FEATURES SETUP
AWARD SOFTWARE, INC.
```

Virus Warning	: Enabled	Video BIOS Shadow	: Disabled
CPU Internal Cache	: Disabled	C8000-CBFFF Shadow	: Disabled
External Cache	: Disabled	CC000-CFFFF Shadow	: Disabled
Quick Power On Self Test	: Disabled	D0000-D3FFF Shadow	: Disabled
Boot Sequence	: A,C,SCSI	D4000-D7FFF Shadow	: Disabled
Swap Floppy Drive	: Disabled	D8000-DBFFF Shadow	: Disabled
Boot Up Floppy Seek	: Disabled	DC000-DFFFF Shadow	: Disabled
Boot Up NumLock Status	: Off		
Boot Up System Speed	: Low		
Gate A20 Option	: Normal		
Typeomatic Rate Setting	: Disabled		
Typeomatic Rate (Chars/Sec)	: 6		
Typeomatic Delay (Msec)	: 250		
Security Option	: Setup		
PCI/VGA Palette Snoop	: Disabled		
OS Select For DRAM > 64MB	: Non-OS2		
		ESC : Quit	↑ + : Select Item
		F1 : Help	PU/PD/+/- : Modify
		F5 : Old Values	(Shift)F2 : Color
		F6 : Load BIOS Defaults	
		F7 : Load Setup Defaults	

Figure 4-3: BIOS features setup

## 4.2.4 Chipset features setup

By choosing the CHIPSET FEATURES SETUP option from the INITIAL SETUP SCREEN menu, the screen below is displayed. This sample screen contains the manufacturer's default values for the PCM-9550F/FM/L.

```
ROM PCI/ISA BIOS (2A59IAKA)
CHIPSET FEATURES SETUP
AWARD SOFTWARE, INC.
```

Auto Configuration	: Disabled	DRAM Refresh Rate	: Disabled
DRAM Leadoff Timing	: 11/7/3	Power-Supply Type	: Auto
DRAM Read Burst (EDO/FP)	: x444/x444	CPU Warning Temperature	: 50°C/122°F
DRAM Write Burst Timing	: x444	***** Warning Mode *****	
Fast EDO Lead Off	: Disabled	Fan On	: Enabled
Refresh RAS# Assertion	: 4 Clks	Speed Down	: Disabled
Fast RAS To CAS Delay	: 3	Warned Beep	: Disabled
DRAM Page Idle Timer	: 2 Clks	Current CPU Temperature	:
DRAM Enhanced Paging	: Enabled		
Fast MA to RAS# Delay	: 2 Clks		
SDRAM(CAS Lat/RAS-to-CAS)	: 2/2	ESC : Quit	↑↓+ : Select Item
SDRAM Speculative Read	: Disabled	F1 : Help	PU/PD/+/- : Modify
System BIOS Cacheable	: Disabled	F5 : Old Values (Shift)	F2 : Color
Video BIOS Cacheable	: Disabled	F6 : Load BIOS Defaults	
8 Bit I/O Recovery Time	: NA	F7 : Load Setup Defaults	
16 Bit I/O Recovery Time	: NA		
Memory Hole At 15M-16M	: Disabled		
PCI 2.1 Compliance	: Disabled		

Figure 4-4: Chipset features setup

## 4.2.5 Power management setup

By choosing the POWER MANAGEMENT SETUP option from the INITIAL SETUP SCREEN menu, the screen below is displayed.

This sample screen contains the manufacturer's default values for the PCM-9550F/FM/L.

```
ROM PCI/ISA BIOS (2A59IAKA)
POWER MANAGEMENT SETUP
AWARD SOFTWARE, INC.
```

Power Management : Disabled	** Reload Global Timer Events **
PM Control by APM : No	IRQ[3-7,9-15],NMI : Disabled
Video Off Method : DPMS	Primary IDE 0 : Disabled
Video Off After : NA	Primary IDE 1 : Disabled
MODEM Use IRQ : NA	Secondary IDE 0 : Disabled
Doze Mode : Disabled	Secondary IDE 1 : Disabled
Standby Mode : Disabled	Floppy Disk : Disabled
Suspend Mode : Disabled	Serial Port : Disabled
HDD Power Down : Disabled	Parallel Port : Disabled
Throttle Duty Cycle : 12.5%	
ZZ Active in Suspend : Disabled	
PCI/VGA Act-Monitor : Disabled	
Soft-Off by PWR-BTTN : Instant-Off	
PowerOn by Ring : Disabled	
Resume by Alarm : Enabled	
Date(of Month) Alarm : 0	ESC : Quit           ↑↓↓+ : Select Item
Time(hh:mm:ss) Alarm : 0:0:0	F1 : Help           PU/PD/+/- : Modify
IRQ 8 Break Suspend : Disabled	F5 : Old Values   (Shift)F2 : Color
	F6 : Load BIOS Defaults
	F7 : Load Setup Defaults

Figure 4-5: Power management setup

## 4.2.6 PnP/PCI configuration

By choosing the PnP/PCI CONFIGURATION option from the Initial Setup Screen menu, the screen below is displayed. This sample screen contains the manufacturer's default values for the PCM-9550F/FM/L.

```
ROM PCI/ISA BIOS (2A59IAKA)
PNP/PCI CONFIGURATION
AWARD SOFTWARE, INC.

PNP OS Installed      : Yes
Resources Controlled By : Manual
Reset Configuration Data : Disabled

IRQ-3 assigned to : PCI/ISA PnP
IRQ-4 assigned to : PCI/ISA PnP
IRQ-5 assigned to : PCI/ISA PnP
IRQ-7 assigned to : PCI/ISA PnP
IRQ-9 assigned to : PCI/ISA PnP
IRQ-10 assigned to : PCI/ISA PnP
IRQ-11 assigned to : PCI/ISA PnP
IRQ-12 assigned to : PCI/ISA PnP
IRQ-14 assigned to : PCI/ISA PnP
IRQ-15 assigned to : PCI/ISA PnP
DMA-0 assigned to : PCI/ISA PnP
DMA-1 assigned to : PCI/ISA PnP
DMA-3 assigned to : PCI/ISA PnP
DMA-5 assigned to : PCI/ISA PnP
DMA-6 assigned to : PCI/ISA PnP
DMA-7 assigned to : PCI/ISA PnP

PCI IDE IRQ Map To : PCI-AUTO
Primary IDE INT# : A
Secondary IDE INT# : A

ESC : Quit          ↑↓+ : Select Item
F1  : Help          PU/PD/+/- : Modify
F5  : Old Values   (Shift)F2 : Color
F6  : Load BIOS Defaults
F7  : Load Setup Defaults
```

Figure 4-6: PnP/PCI configuration

## 4.2.7 Integrated peripherals

By choosing the INTEGRATED PERIPHERALS option from the INITIAL SETUP SCREEN menu, the screen below is displayed. This sample screen contains the manufacturer's default values for the PCM-9550F/FM/L. By default, the PANEL TYPE supports an 18-bit 640 x 480 TFT LCD panel display.

```
ROM PCI/ISA BIOS (2A59IAKG)
INTEGRATED PERIPHERALS
AWARD SOFTWARE, INC.

IDE HDD Block Mode      : Enabled
IDE Primary Master PIO  : Auto
IDE Primary Slave PIO   : Auto
IDE Primary Master UDMA : Auto
IDE Primary Slave UDMA  : Auto
IDE Secondary Master PIO : Auto
IDE Secondary Slave PIO  : Auto
IDE Secondary Master UDMA : Auto
IDE Secondary Slave UDMA : Auto
On-Chip Primary PCI IDE : Enabled
On-Chip Secondary PCI IDE : Enabled
Onboard PCI Ethernet Chip : Enabled
USB Keyboard Support     : Disabled
Onboard FDC Controller   : Enabled
Onboard Serial Port 1    : 3F8
Onboard Serial Port 2    : 2F8
Onboard IR Controller    :
IR Address Select       : 2E8H
IR Mode                 :
IR Transmission delay   : Enabled

IR Mode Use DMA         : Disable
Onboard Parallel Port   :
Parallel Port Mode      :
ECP Mode Use DMA        : 3
EPP Mode Select         : EPP1.9
Onboard Serial Port 3   : 3E8
Onboard Serial Port 4   : 2E8
Serial Port 1/2/3/4 IRQ : 4/3/10/5
Vector Hi/Low select    : Low
Vector Address Decoder   : 200
Onboard Parallel Port 2 : 278
Parallel Port 2 Use IRQ : IRQ5
Parallel Port 2 Mode    : ECP+EPP1.9
LPT2 ECP Mode Use DMA   : 1
Boot Up Display Type    : Simultaneous
Panel Output Drive      : Higher Drive
Panel Type               : By Hardware Jumper
```

Figure 4-7: Integrated peripherals



## 4.2.9 Change password

To change the password, choose the PASSWORD SETTING option from the Setup main menu and press <Enter>.

1. If the CMOS is bad or this option has never been used, a default password is stored in the ROM. The screen will display the following messages:

**Enter Password:**

Press <Enter>.

2. If the CMOS is good or this option has been used to change the default password, the user is asked for the password stored in the CMOS. The screen will display the following message:

**Confirm Password:**

Enter the current password and press <Enter>.

3. After pressing <Enter> (ROM password) or the current password (user-defined), you can change the password stored in the CMOS. The password can only be eight (8) characters long at most.

Remember - to enable this feature, you must first select either Setup or System in BIOS FEATURES SETUP.

#### **4.2.10 Auto detect hard disk**

The IDE HDD AUTO DETECTION utility can automatically detect the IDE hard disk installed in your system. You can use it to self-detect and/or correct the hard disk type configuration.

#### **4.2.11 Save & exit setup**

If you select this option and press <Enter>, the values entered in the setup utilities will be recorded in the chipset's CMOS memory. The microprocessor will check this every time you turn your system on, and compare this to what it finds as it checks the system. This record is required for the system to operate.

#### **4.2.12 Exit without saving**

Selecting this option and pressing <Enter> lets you exit the Setup program without recording any new values or changing old ones.

# CHAPTER 5

## PCI SVGA Setup

- Introduction
- Installation of SVGA driver for
  - Windows 3.1
  - Windows 95
  - Windows NT
- Further information

## 5.1 Introduction

---

The PCM-9550F/FM/L has an on-board PCI flat panel/VGA interface. The specifications and features are described as follows:

### 5.1.1 Chipset

The PCM-9550F/FM/L uses a C&T 6900/69030 chipset for its PCI/SVGA controller. It supports many popular LCD, EL, and gas plasma flat panel displays, as well as conventional analog CRT monitors. The 6900/69030 VGA BIOS supports monochrome LCD, EL, color TFT, and STN LCD flat panel displays. In addition, it also supports interlaced and non-interlaced analog monitors (color and monochrome VGA) in high-resolution modes, while maintaining complete IBM VGA compatibility. Digital monitors (i.e. MDA, CGA, and EGA) are NOT supported. Multiple frequency (multisync) monitors are handled as if they were analog monitors.

### 5.1.2 Display memory

With on-board 2 MB display memory, the VGA controller can drive CRT displays or color panel displays with resolutions up to 1024 x 768 @ 64 K colors. With C&T 69030, the display memory can be expanded to 4 MB for true-color resolution of 1024 x 768.

### 5.1.3 Display types

CRT and panel displays can be used simultaneously. The PCM-9550F/FM/L can be set in one of three configurations: on a CRT, on a flat panel display, or on both simultaneously. The system is initially set to simultaneous display mode. The CD utility disc includes three \*.COM files in the subdirectory

**Biscuit\9550F\Utility** which can be used to configure the display. In order to use these configuration programs, type the file name and path at the DOS prompt.

CT.COM: Enables CRT display only

FP.COM: Enables panel display only

SM.COM: Enables both displays simultaneously

## 5.2 Installation of SVGA driver

---

Complete the following steps to install the SVGA driver. Follow the procedures in the flow chart that apply to the operating system that you are using within your PCM-9550F/FM/L.

*Important: The following windows illustrations are examples only. You must follow the flow chart instructions and pay attention to the instructions which then appear on your screen.*

*Note: <Enter> means pressing the “Enter” key on the keyboard.*

## 5.2.1 Installation for Windows 95/98

1. Select "Start", "Settings", "Control Panel", "Display", "Settings". Then click on "Advanced Properties".

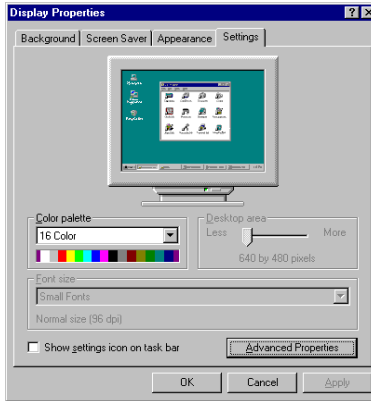

2. Choose the "Adaptor" label. Press "Change..."

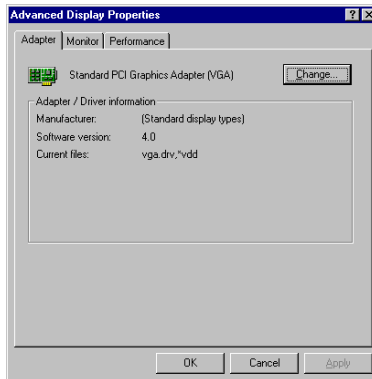

3. Press the "Have Disk" button.

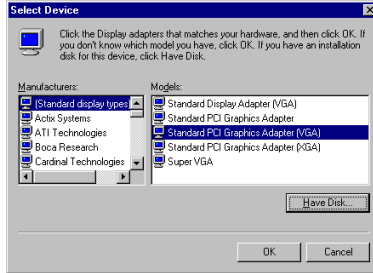

4. Insert the utility disk into the floppy disk drive.

Type: "D:\Biscuit\9550F\VGA\69000\Win95"

Press "OK".



5. Select the highlighted item.

Click the "OK" button.

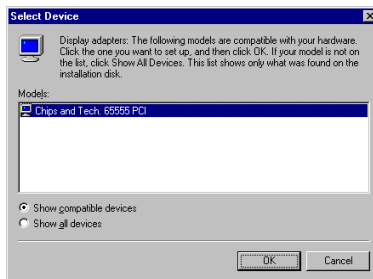

6. C&T69000/69030 appears in the adapter label. Click on the "Apply" button.

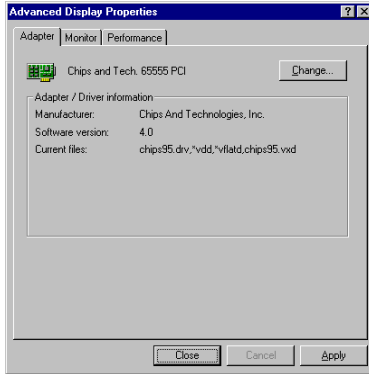

7. Press "Yes" to reboot.

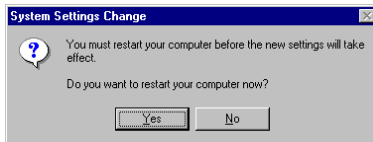

8. Repeat Step 1. The "CHIPS" label appears in the "Display". Adjust resolution and color.

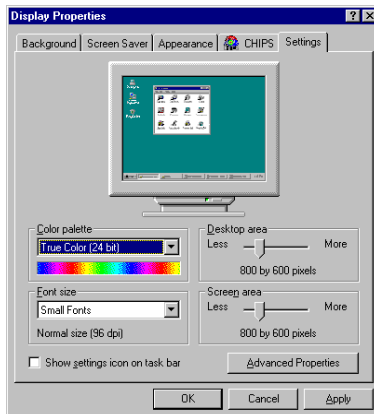

9. Click the "CHIPS" label. Adjust the refresh rate and display type. Press "OK" to exit.

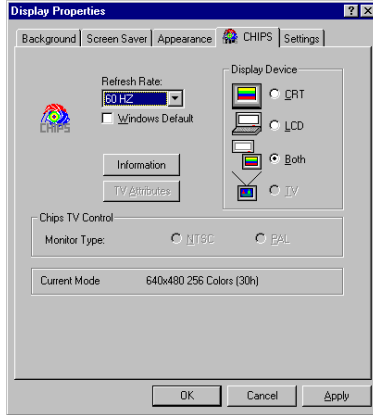

10. Press "Yes" to set the monitor type.

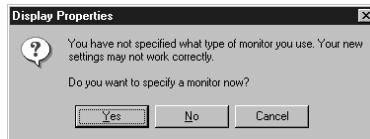

11. Select "Standard", "Super VGA 800 x 600". or "XGA". Then press the "OK" button.

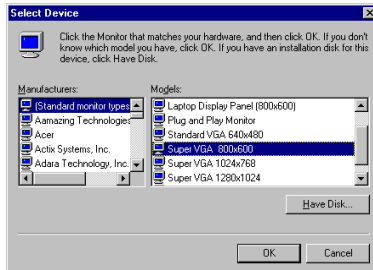

12. Choose "Restart" to reboot. End

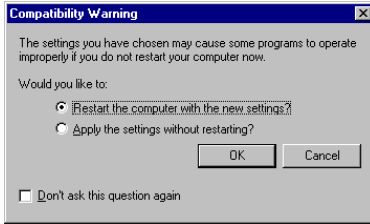

*Note:* 1. In step 4, for Windows 98, the path is:  
"D:\Biscuit\9550F\VGA\69000\Win98\"

2. In step 4, for the 4 MB VGA version, the path is:  
"D:\Biscuit\9550F\VGA\69030\"

## 5.2.2 Installation for Windows 3.1

1. Insert the utility disk into the floppy disk drive.

Select "File" in the Program Manager.

Click "Run" and type:

"D:\Biscuit\9550F\VGA\69000\Win31\Setup.exe".

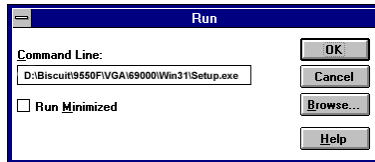

2. Choose the language you want to use during installation.



3. Select the highlighted item. Press "ENTER".

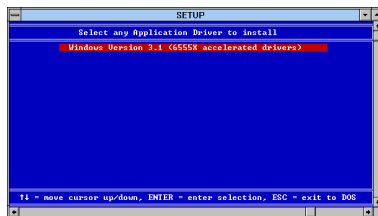

4. Press "ENTER" to install all resolutions.

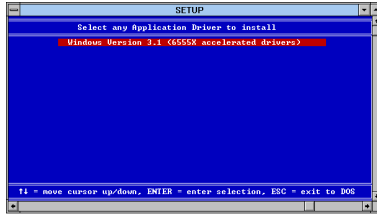

5. Type the path of the operating system.

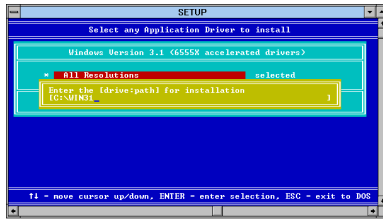

6. When installation is complete, reboot the system.

You will see the "ChipsCPL" icon in the control panel.

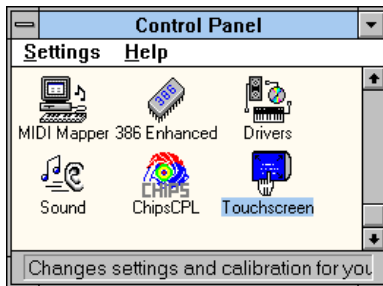

7. Double click "ChipsCPL".

Adjust the screen size, color and refresh rate to your preferences.

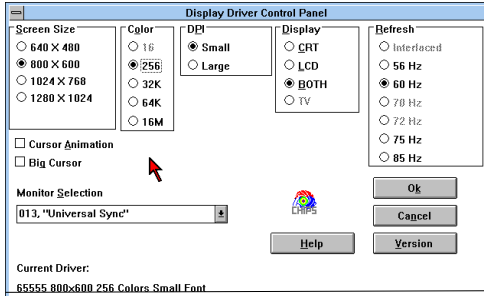

## 5.3 Further information

For further information about PCI/SVGA installation in your PCM-9550F/FM/L, including driver updates, troubleshooting guides and FAQ lists, visit the following web resources:

Asillion website: [www.asilian.com](http://www.asilian.com)

Advantech websites: [www.advantech.com](http://www.advantech.com)

[www.advantech.com/support](http://www.advantech.com/support)

## 5.3 Further information

---

For further information about PCI/SVGA installation in your PCM-9550F/FM/L, including driver updates, troubleshooting guides and FAQ lists, visit the following web resources:

Asillion website: [\*\*www.asilian.com\*\*](http://www.asilian.com)

Advantech websites: [\*\*www.advantech.com\*\*](http://www.advantech.com)  
[\*\*www.advantech.com/support\*\*](http://www.advantech.com/support)

## 5.2.3 Installation for Windows NT

1. Select "Start", "Settings", "Control Panel", then double click the "Display" icon.

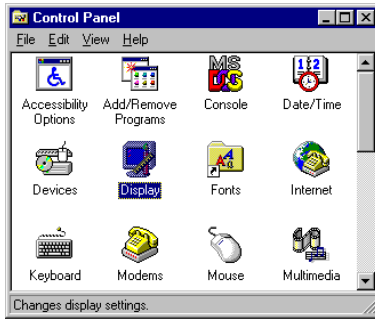

2. Choose the "Settings" label. Then press the "Display Type" button.

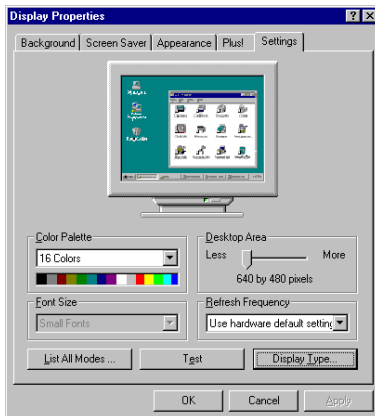

3. Press the "Change...." button.

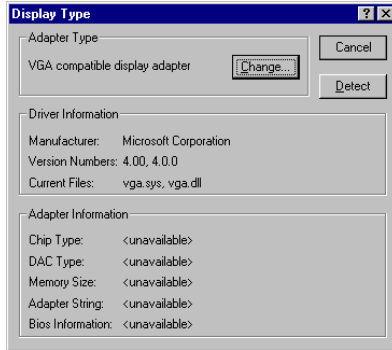

4. Click the 'Have Disk...' button.

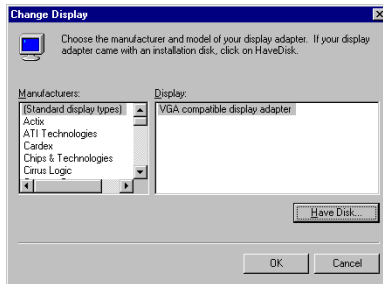

5. Insert the utility disk into the floppy disk drive.

Type: "D:\Biscuit\9550F\VGA\69000\Winnt"

Press the "OK" button.

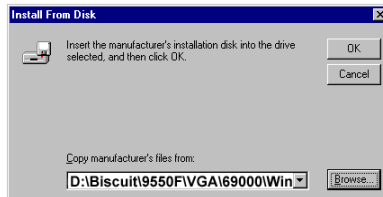

6. Select the highlighted item.

Press the "OK" button.

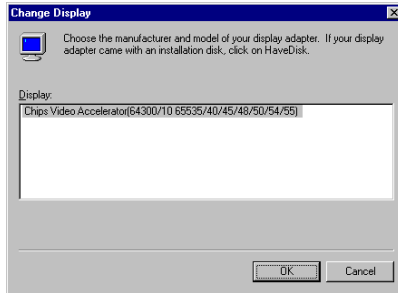

7. Press "Yes" to proceed.

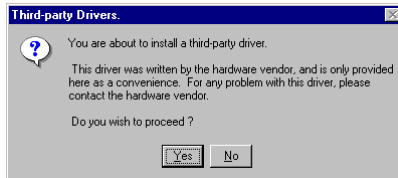

8. Press "OK" to reboot.

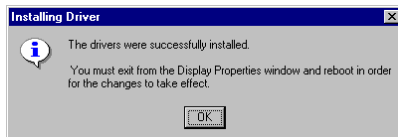

9. Repeat Step 1 to select the "Settings" label.

Adjust resolution and color.

Click "Test" to see the result.

Click "OK" to save the setting. End

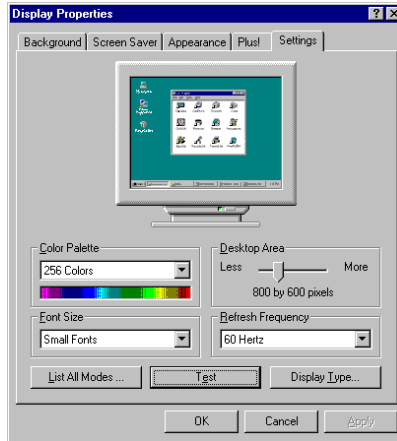

## 5.3 Further information

---

For further information about PCI/SVGA installation in your PCM-9550F/FM/L, including driver updates, troubleshooting guides and FAQ lists, visit the following web resources:

Asillion website: **[www.asilian.com](http://www.asilian.com)**

Advantech websites: **[www.advantech.com](http://www.advantech.com)**  
**[www.advantech.com/support](http://www.advantech.com/support)**



# CHAPTER 6

## **Video (PCM-9550FM only)**

- Introduction
- Installation of video capture driver for Windows 95/98

## 6.1 Introduction

---

The PCM-9550FM's on-board Video-in and Video-out (TV-out) provides NTSC and PAL video standards. Video-in uses Philips SAA 7111A video input processor. TV-out uses CHRONTEL CH7002. Video-in/out provides a 14-pin header connector for RCA Yellow jack for composite video in and TV out. Alternatively, an optional cable kit provides an S-Video connector.

## 6.2 Installation of video driver

---

Before installing the Video-in driver, please take note of the procedures detailed below. You must know which operating system you are using in your PCM-9550FM, and then refer to the corresponding installation flow chart. Just follow the steps in the flow chart. You can quickly and successfully complete the installation, even if you are not familiar with instructions for Windows.

*Note:*        *The CD-ROM drive is designated as "D" throughout this chapter.*

## 6.2.1 Installation for Windows 95/98

1. Select "Start," "Settings," "Control Panel," "Add New Hardware."

Click "Next" to begin installing the new device.

Click "Next" to continue.



2. Choose "No, I want to select hardware...."

Click "Next."



3. Select "Sound, video,..."

Click "Next"



4. Click "Have Disk..."



5. Insert the disk into the CD-ROM drive.

Type the correct path:

D:\Biscuit\9550FM\VGA\69000\Capture"

Click the "OK" button.



6. Select the highlighted item.

Click "OK"



7. Click "Finish" to complete. End



*Note:* Before you restart Windows, insert the following *pcvideo.ini* and *ctmmhw.ini* files into the Windows directory:

```
[GPIO]
GPIO_SDA=0
GPIO_SCL=1
```

## 6.3 Installation of Chips-TV utility

---

This utility is for demonstration only.

1. Select "Start," "Run."

Type the correct path:

"D:\Biscuit\9550FM\VGA\69000\Chips-TV\Setup.exe"

Click "OK"



2. Click "Continue"



3. Click "Continue"

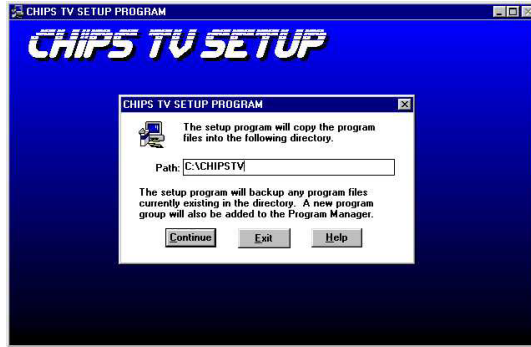

4. Click "OK" to complete the setup. End



# CHAPTER 7

## **Audio (PCM-9550F/9550FM only)**

- Introduction
- Installation of audio driver for Windows 95/98/NT

## 7.1 Introduction

---

The PCM-9550F/FM on-board audio interface provides high-quality stereo sound and FM music synthesis (ESFM) by using the ES1373 audio controller from Creative Technology Ltd. The audio interface can record, compress, and play back voice, sound, and music with a built-in mixer control. The PCM-9550F/FM's on-board audio interface also supports the Plug and Play (PnP) standard and provides PnP configuration for audio, FM, and MPU-104 logical devices. It is compatible with AC97 version 2.0, voice, and music functions. The ESFM synthesizer is register compatible with the OPL3 and has extended capabilities.

## 7.2 Installation of audio driver

---

Before installing the audio driver, please take note of the procedures detailed below. You must know which operating system you are using in your PCM-9550F/FM, and then refer to the corresponding installation flow chart. Just follow the steps in the flow chart. You can quickly and successfully complete the installation, even though you are not familiar with instructions for Windows.

*Note:* The CD-ROM drive is designated as "D" throughout this chapter.

*Note:* The PCM-9550F Audio driver is the same as PCM-9574's. Users can reference it on the CD.

*Note:* 1. In step 1, for Windows 98, the path is:

*D:/Biscuit/9550F(9574)/audio/Win98/setup.exe.*

2. In step 1 for Windows 2000, the path is:

*D:/Biscuit/9550F(9574)/audio/win2k/setup.exe.*

3. In step 1, for Windows NT, the path is:

*D:/Biscuit/9550F(9574)/audio/winnt/setup.exe.*

## 7.2.1 Installation for Windows 95/98/NT



1. a. Select "Start", "Run"
  - b. Type the correct path"  
D:\Biscuit\9550F\Audio\Win95\
    - c. Click the "OK" button



2. a. Click "Yes" to accept the agreement
  - b. On the next page, read the Readme file then click "Next"

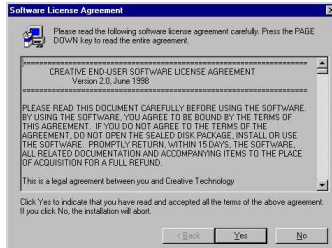

3. a. Click "Next" to continue
- b. Follow the procedure which appears on your screen



4. After installation, select "Yes" and click "Finish" to restart the computer





## PCI Bus Ethernet Interface

This chapter provides information on Ethernet configuration.

- Introduction
- Installation of Ethernet driver for Windows 95/98/NT
- Further information

## 8.1 Introduction

---

The PCA-9550F/FM/L is equipped with a high performance 32-bit Ethernet chipset which is fully compliant with IEEE 802.3 100 Mbps CSMA/CD standards. It is supported by major network operating systems. It is also both 100Base-T and 10Base-T compatible. The medium type can be configured via the RSET8139.exe program included on the utility disk.

The Ethernet port provides a standard RJ-45 jack via an optional wiring kit. The network boot feature can be utilized by incorporating the boot ROM image files for the appropriate network operating system. The boot ROM BIOS files are combined with system BIOS, which can be enabled/disabled in the BIOS setup.

## 8.2 Installation of Ethernet driver

---

Before installing the Ethernet driver, note the procedures below. You must know which operating system you are using in your PCA-9550F/FM/L, and then refer to the corresponding installation flow chart. Then just follow the steps described in the flow chart. You will quickly and successfully complete the installation, even if you are not familiar with instructions for MS-DOS or Windows.

*Note: The windows illustrations in this chapter are examples only. You must follow the flow chart instructions and pay attention to the instructions which then appear on your screen.*

### 8.2.1 Installation for MS-DOS and Windows 3.1

If you want to set up your Ethernet connection under the MS-DOS or Windows 3.1 environment, you should first check your server system model. For example, MS-NT, IBM-LAN server, and so on.

Then choose the correct driver to install in your panel PC.

The installation procedures for various servers can be found on CD-ROM, the correct path being:

**D:\Biscuit\9550F\LAN\8139C\wfw311**

## 8.2.2 Installation for Windows 95/98

- 1.a. Select “Start”, “Settings”, “Control Panel”
- b. Double click “Network”



2. Click "Add" and prepare to install network functions

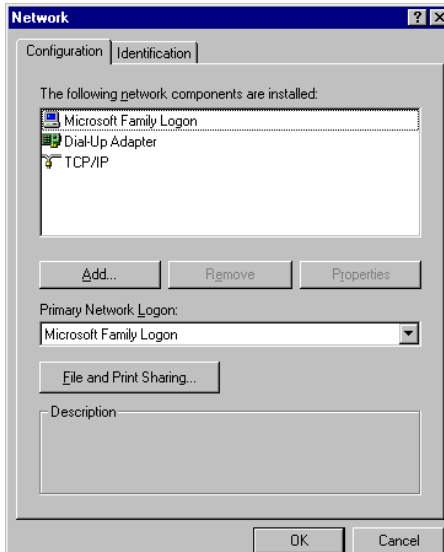

3. Select the "Adapter" item to add the Ethernet card.

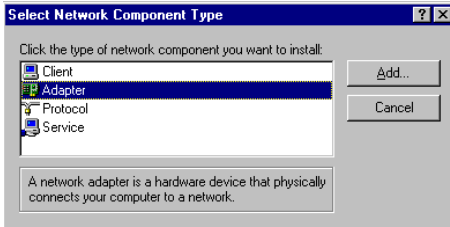

4. Click "Have Disk" to install the driver.

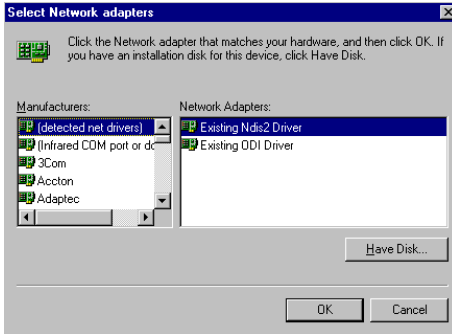

- 5.a. Insert the Utility CD ROM  
b. Fill in the correct path  
D:\Biscuit\9550F\LAN\8139C\WIN98  
c. Click "OK"



- 6.a. Choose the "Realtek RTL8139(A/B/C/8130) PCI Fast Ethernet".
- b. Click "OK"

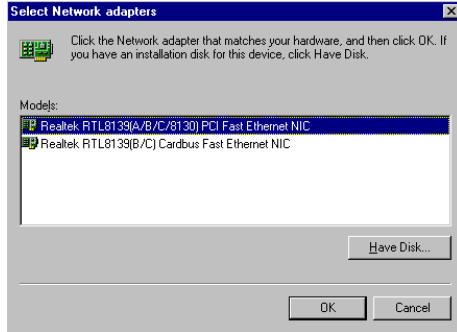

- 7.a. Make sure the configurations of the relative items are set correctly.
- b. Click "OK" to reboot.

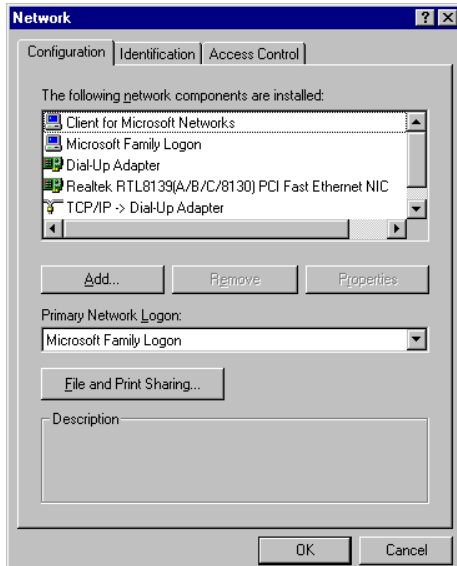

## 8.2.3 Installation for Windows NT

- 1.a. Select “Start”, “Settings”, “Control Panel”
- b. Double click “Network”



- 2.a. Choose the type of network
- b. Click "next"

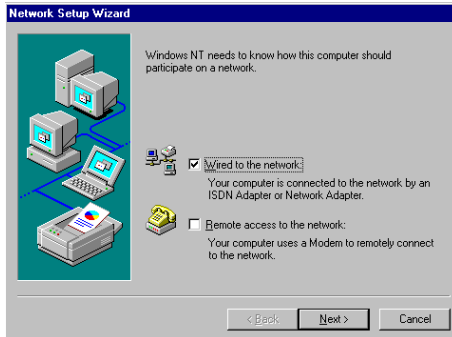

3. Click "Select from list..."

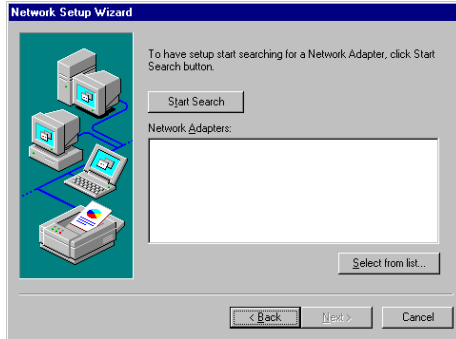

4. Click "Have Disk"

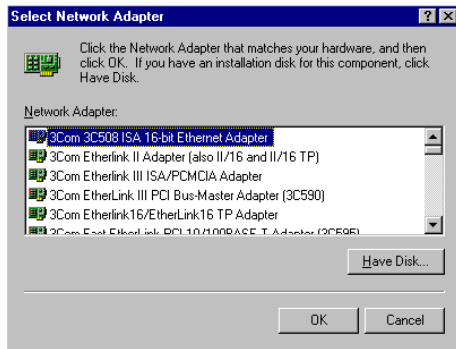

- 5.a. Insert the Utility CD ROM  
b. Fill in the correct path  
D:\Biscuit\9550F\LAN\8139C\winnt4  
c. Click "OK"

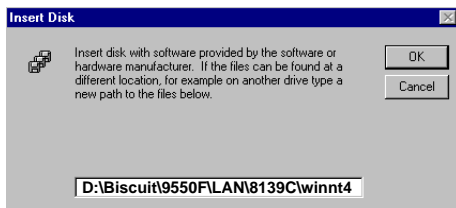

- 6.a. Choose the highlighted item
- b. Click "OK"

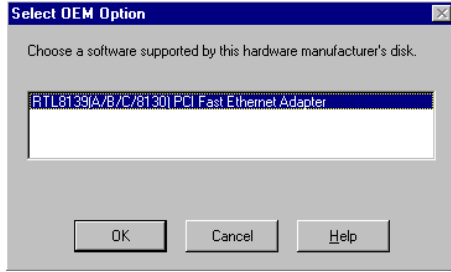

- 7. Click "Next" to continue setup

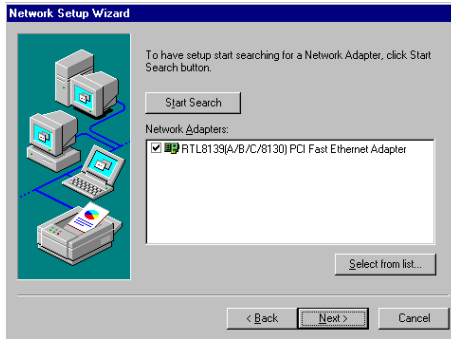

- 8.a. Choose the networking protocols
- b. Click "Next"

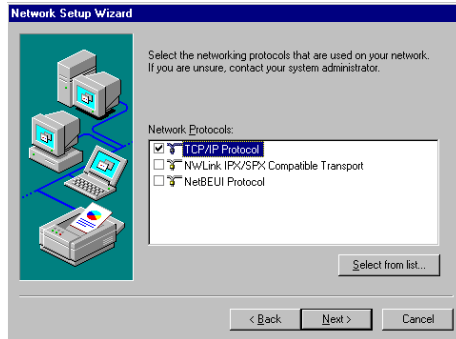

- 9.a. Choose the Network Services
- b. Click "Next"

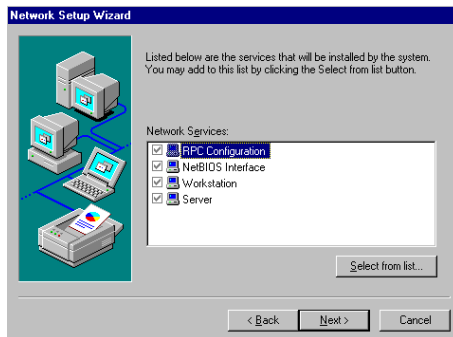

10. Click "Next" to continue setup

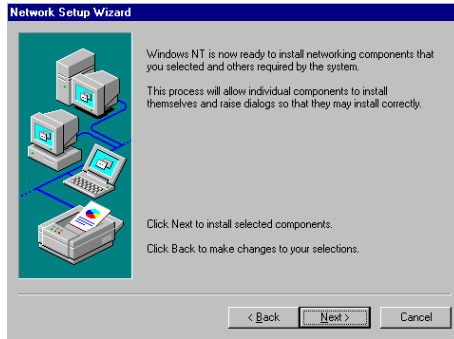

11. Click "Next" to start the network

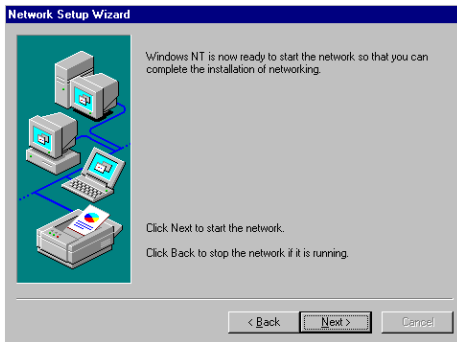

## 8.3 Further information

---

Realtek website:	<a href="http://www.realtek.com.tw">www.realtek.com.tw</a>
Advantech websites:	<a href="http://www.advantech.com">www.advantech.com</a> <a href="http://www.advantech.com.tw">www.advantech.com.tw</a>
Intel website:	<a href="http://www.intel.com">www.intel.com</a>

# APPENDIX **A**

## **Programming the Watchdog Timer**

The PCM-9550F/FM/L is equipped with a watchdog timer that resets the CPU or generates an interrupt if processing comes to a standstill for any reason. This feature ensures system reliability in industrial standalone or unmanned environments.

## A.1 Programming the watchdog timer

---

In order to program the watchdog timer, you must write a program which writes I/O port address 443 (hex). The output data is a value of time interval. The value range is from 01 (hex) to 3E (hex), and the related time interval is 1 sec. to 62 sec.

<b>Data</b>	<b>Time Interval</b>
01	1 sec.
02	2 sec.
03	3 sec.
04	4 sec.
	.
	.
	.
3E	62 sec.

After data entry, your program must refresh the watchdog timer by rewriting the I/O port 443 (hex) while simultaneously setting it.

When you want to disable the watchdog timer, your program should read I/O port 443 (hex).

The following example shows how you might program the watchdog timer in BASIC:

```
10      REM Watchdog timer example program
20      OUT &H443, data REM Start and restart the
        watchdog
30      GOSUB 1000 REM Your application task #1
40      OUT &H443, data REM Reset the timer
50      GOSUB 2000 REM Your application task #2
60      OUT &H443, data REM Reset the timer
70      X=INP (&H443) REM Disable the watchdog
        timer
80      END

1000    REM Subroutine #1, your application task
        .
        .
        .
1070    RETURN
2000    REM Subroutine #2, your application task
        .
        .
        .
2090    RETURN
```



APPENDIX **B**

## **Installing PC/104- Plus Modules**

This appendix gives instructions for installing PC/104- Plus modules.

## B.1 Installing PC/104 modules

---

The PCM-9550F/FM/L's PC/104 connectors give you the flexibility to attach PC/104+ modules.

Installing these modules on the PCM-9550F/FM/L is quick and simple. The following steps show how to mount the PC/104+ modules:

1. Remove the PCM-(550F/M from your system, paying particular attention to the safety instructions already mentioned above.
2. Make any jumper or link changes required to the CPU card now. Once the PC/104+ module is mounted, you may have difficulty in accessing these.
3. Normal PC/104+ modules have male connectors and mount directly onto the main card. (Refer to the diagram on the following page.)
4. Mount the PC/104+ module onto the CPU card by pressing the module firmly but carefully onto the mounting connectors.
5. Secure the PC/104+ module onto the CPU card using the four mounting spacers and screws.

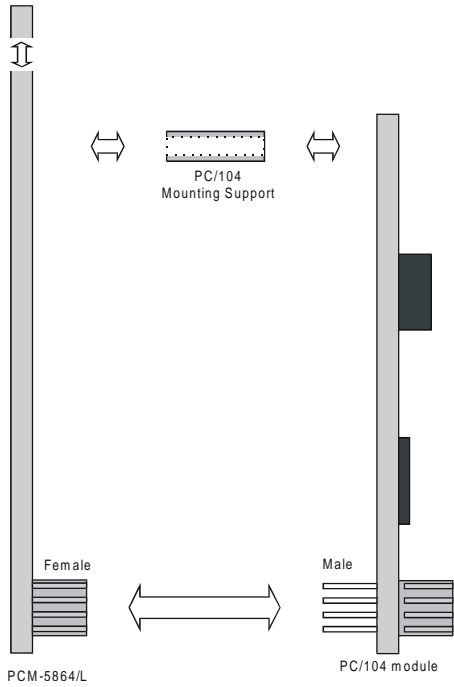

Figure B-1: PC/104+ module mounting diagram

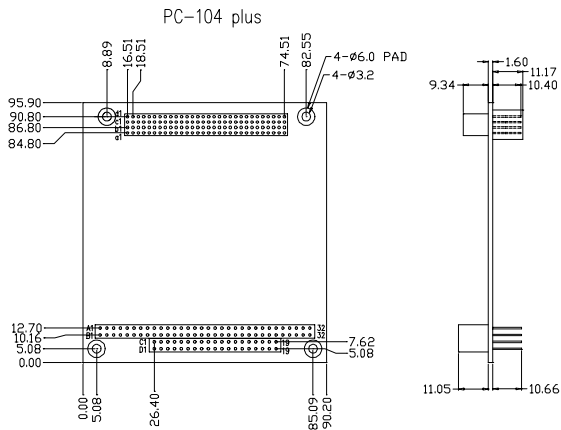

Figure B-2: PC/104+ module dimensions (mm) ( $\pm 0.1$ )



## Pin Assignments

This appendix contains information of a detailed or specialized nature. It includes:

- CPU fan power connector
- Ethernet 10/100Base-T connector
- Audio connector
- CD audio input connector
- Main power connector
- Keyboard and PS/2 mouse connector
- Floppy disk drive connector
- PC/104 connectors
- IDE (1st, 2nd) HDD connector
- Parallel port connector (LPT 1, LPT 2)
- Front panel connector
- USB connector
- Backlight connector
- IR connector
- CRT display connector
- Video In-Out connector
- Flat panel connector
- Ext. flat panel connector
- Peripheral power connector
- CompactFlash card connector
- ATX power feature connector
- 8 digital I/O
- 2 digital outputs
- COM port connector

## C.1 CPU fan power connector (CN24)

---

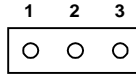

Table C-1: CPU fan power connector (CN24)

Pin	Signal
1	+5 V
2	GND
3	+12 V

## C.2 Ethernet 10/100Base-T connector (CN6)

---

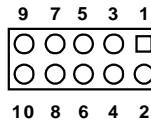

Table C-2: Ethernet 10/100Base-T connector (CN6)

Pin	Signal
1	$V_{cc}$
2	CRS LED
3	RCV+
4	RCV-
5	BNC LED
6	GND
7	N/C
8	GND
9	XMT+
10	XMT-

## C.3 Audio connector (CN12) (PCM-9550F/9550FM only)

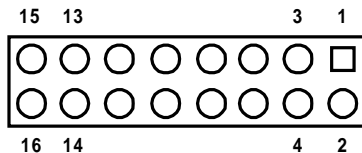
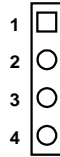

Table C-3: Audio connector (CN12)

Pin	Signal	Pin	Signal
1	SPEAKER OUT R+	2	SPEAKER OUT R-
3	SPEAKER OUT L+	4	SPEAKER OUT L-
5	LINE OUT R	6	LINE OUT L
7	GND	8	GND
9	LINE IN R	10	LINE IN L
11	GND	12	GND
13	NC	14	NC
15	MIC IN	16	GND

## C.4 CD audio input connector (CN11) (PCM-9550F/9550FM only)

---



---

Table C-4: Aux line-in connector (CN11)

---

<b>Pin</b>	<b>Signal</b>
1	CD Audio L
2	GND
3	GND
4	CD Audio R

---

## C.5 Main power connector (CN8)

---

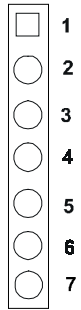

---

Table C-5: Main power connector (CN8)

---

Pin	
1	+5 V
2	GND
3	GND
4	+12 V
5	N.C.
6	GND
7	+5 V

---

## C.6 Keyboard and PS/2 mouse connector (CN10)

---

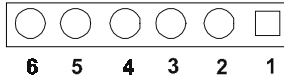

---

Table C-6: Keyboard and mouse connector (CN10)

---

Pin	Signal
1	KB CLOCK
2	KB DATA
3	MS CLOCK
4	GND
5	+5V (KB VCC)
6	MS DATA

---

## C.7 Floppy disk drive connector (CN19)

Table C-7: Floppy disk drive connector (CN19)

Pin	Signal	Pin	Signal
1	GND	2	DENSITY SELECT*
3	GND	4	N/C
5	GND	6	DRIVE TYPE
7	GND	8	INDEX*
9	GND	10	MOTOR 0*
11	GND	12	DRIVE SELECT 1*
13	GND	14	DRIVE SELECT 0*
14	GND	16	MOTOR 1*
17	GND	18	DIRECTION*
19	GND	20	STEP*
21	GND	22	WRITE DATA*
23	GND	24	WRITE GATE*
25	GND	26	TRACK 0*
27	GND	28	WRITE PROTECT*
29	GND	30	READ DATA*
31	GND	32	HEAD SELECT*
33	GND	34	DISK CHANGE*

\*low active

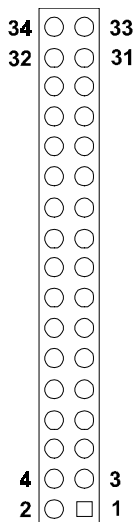

# C.8 PC/104+ connectors (CN18)

CN18 (ISA bus long side)

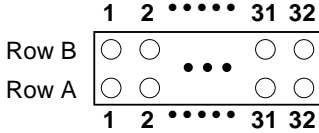

CN18 (ISA bus short side)

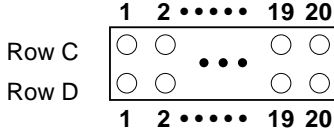
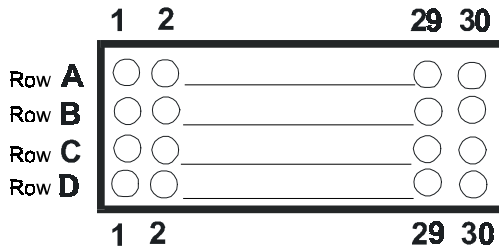

Table C-8: PC/104+ connectors (CN18)

Pin Number	Signal (CN18)			Signal (CN18) RowD
	RowA	RowB	RowC	
1	IOCHCK*	GND	GND	GND
2	SD7	RESET	SBHE*	MEMCS16*
3	SD6	+5 V	LA23	IOCS16*
4	SD5	IRQ9	LA22	IRQ10
5	SD4	-5V	LA21	IRQ11
6	SD3	DRQ2	LA20	IRQ12
7	SD2	-12V	LA19	IRQ15
8	SD1	ENDXFR*	LA18	IRQ14
9	SD0	+12V	LA17	DACK0*
10	IOCHRDY	(KEY)	MEMR*	DRQ0
11	AEN	SMEMW*	MEMW*	DACK5*
12	SA19	SMEMR*	SD8	DRQ5
13	SA18	IOW*	SD9	DACK6*
14	SA17	IOR*	SD10	DRQ6
15	SA16	DACK3*	SD11	DACK7*
16	SA15	DRQ3	SD12	DRQ7
17	SA14	DACK1*	SD13	+5V

PC/104+ connectors (cont.)

Pin number	Signal (CN18)		Signal (CN18)	
	RowA	RowB	RowC	RowD`
* low active				
18	SA13	DRQ1	SD14	MASTER*
19	SA12	REFRESH*	SD15	0V
20	SA11	SYSCLK	(KEY)	0V
21	SA10	IRQ7	----	----
22	SA9	IRQ6	----	----
23	SA8	IRQ5	----	----
24	SA7	IRQ4	----	----
25	SA6	IRQ3	----	----
26	SA5	DACK2*	----	----
27	SA4	TC	----	----
28	SA3	BALE	----	----
29	SA2	+5V	----	----
30	SA1	OSC	----	----
31	SA0	0V	----	----
32	0V	0V	----	----
* low active				



CN18: PC/104-Plus connector (PCI bus)  
(PCM-9550F/9550FM only)

Table C-9: PC/104+ Bus signal assignments (CN18)

Pin Number	Signal (CN18)			Signal (CN18) RowD
	RowA	RowB	RowC	
1	GND/5V/KEY	RESERVED	+5	AD00
2	VI/O	AD02	AD01	+5V
3	AD05	GND	AD04	AD03
4	C/BE0*	AD07	GND	AD06
5	GND	AD09	AD08	GND
6	AD11	VI/O	AD10	M66EN
7	AD14	AD13	GND	AD12
8	+3.3V	C/BE1*	AD15	+3.3V
9	SERR*	GND	SB0*	PAR
10	GND	PERR*	+3.3V	SDONE
11	STOP*	+3.3V	LOCK*	GND
12	+3.3V	TRDY*	GND	DEVSEL*
13	FRAME*	GND	IRDY*	+3.3V
14	GND	AD16	+3.3V	C/BE2*
15	AD18	+3.3V	AD17	GND
16	AD21	AD20	GND	AD19
17	+3.3V	AD23	AD22	+3.3V
18	IDSELO	GND	IDSEL1	IDSEL2
19	AD24	C/BE3*	VI/O	IDSEL3
20	GND	AD26	AD25	GND
21	AD29	+5V	AD28	AD27
22	+5V	AD30	GND	AD31
23	REQ0*	GND	REQ1*	VI/O
24	GND	REQ2*	+5V	GNT0*
25	GNT1*	VI/O	GNT2*	GND
26	+5V	CLK0	GND	CLK1
27	CLK2	+5V	CLK3	GND
28	GND	INTD*	+5V	RST*
29	+12V	INTA*	INTB*	INTC*
30	-12V	Reserved	Reserved	GND/3.3V KEY

\* low active

## C.9 IDE HDD connector (CN16, 17)

Pin	Signal	Pin	Signal
1	IDE RESET*	2	GND
3	DATA 7	4	DATA 8
5	DATA 6	6	DATA 9
7	DATA 5	8	DATA 10
9	DATA 4	10	DATA 11
11	DATA 3	12	DATA 12
13	DATA 2	14	DATA 13
15	DATA 1	16	DATA 14
17	DATA 0	18	DATA 15
19	SIGNAL GND	20	N/C
21	HDD 0	22	GND
23	IO WRITE	24	GND
25	IO READ	26	GND
27	HD READY	28	N/C
29	HDACK 0*	30	GND
31	IRQ14	32	N/C
33	ADDR 1	34	N/C
35	ADDR 0	36	ADDR 2
37	HARD DISK SELECT 0*	38	HARD DISK SELECT 1*
39	IDE ACTIVE*	40	GND
41	VCC	42	VCC
43	GND	44	N/C

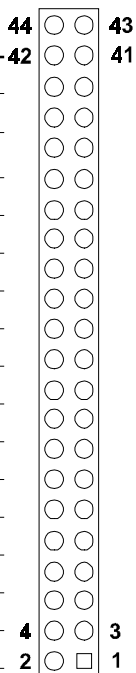

\* low active

## C.10 Parallel port connector (CN21, CN22)

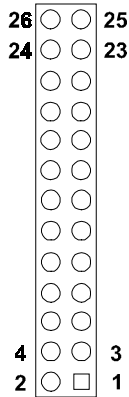

Table C-11: Parallel port connector (CN21, CN22)

Pin	Signal	Pin	Signal
1	STROBE*	2	AUTOFD*
3	D0	4	ERR
5	D1	6	INIT*
7	D2	8	SLCTINI*
9	D3	10	GND
11	D4	12	GND
13	D5	14	GND
15	D6	16	GND
17	D7	18	GND
19	ACK*	20	GND
21	BUSY	22	GND
23	PE	24	GND
25	SLCT	26	N/C

\* low active

Note: CN21 applies to PCM-9550F/9550FM only.

# C.11 Front panel connector (CN13)

---

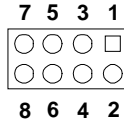

Table C-12: Front panel connector (CN13)

Pin	Signal
1	HDD LED- (HARD DISK ACTIVE)
2	HDD LED+ ( $V_{CC}$ )
3	SPEAKER+
4	SPEAKER- (GND)
5	GND
6	WATCHDOG OUTPUT*
7	RESET SWITCH- (GND)
8	RESET SWITCH+

\* low active

## C.12 USB connector (CN15)

---

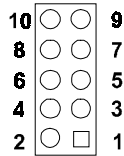

Table C-13: USB connector (CN15)

Pin	Signal	Pin	Signal
1	+5 V	2	+5 V
3	UV-	4	UV-
5	UV+	6	UV+
7	GND	8	GND
9	Chassis GND	10	N/C

## C.13 LCD inverter backlight connector (CN7)

---

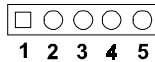

Table C-14: LCD inverter connector (CN7)

Pin	Signal
1	+12 V
2	GND
3	ENABKL
4	Reserve (VBR)
5	+ 5 V

## C.14 IR connector (CN27)

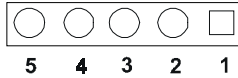

Table C-15: IR connector (CN27)

Pin	Signal
1	$V_{CC}$
2	FIR REceive
3	IR REceive
4	GND
5	FIR/IR Transmit

## C.15 CRT display connector (CN1)

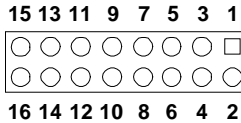

Table C-16: CRT display connector (CN1)

Pin	Signal	Pin	Signal
1	RED	9	VGA G
2	VGA DT	10	VGA H
3	GREEN	11	VGA G
4	VGA G	12	VGA V
5	BLUE	13	VGA G
6	VGA CK	14	N/C
7	N/C	15	VGA G
8	N/C	16	N/C

## C.16 Video in/out connector (CN2)

---

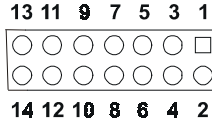

Table C-17: Video in/out connector (CN2)

Pin	Signal
1	AI22
2	GND
3	GND
4	AI21
5	AI12
6	GND
7	GND
8	AI11
9	Composite out
10	GND
11	luminance
12	GND
13	chrominance
14	GND

*Note: Pin1~pin8 for video-in*

*Pin7~pin14 for video-out (TV out)*

## C.17 24-bit LCD display connector (CN14)

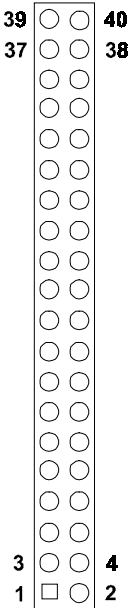

Table C-18: 24-bit LCD display connector (CN14)

Pin	Signal	Pin	Signal
1	VDDSAFE5	2	VDDSAFE5
3	GND	4	GND
5	VDDSAFE3	6	VDDSAFE3
7	Vcon	8	GND
9	P0	10	P1
11	P2	12	P3
13	P4	14	P5
15	P6	16	P7
17	P8	18	P9
19	P10	20	P11
21	P12	22	P13
23	P14	24	P15
25	P16	26	P17
27	P18	28	P19
29	P20	30	P21
31	P22	32	P23
33	GND	34	GND
35	SHIFT CLOCK	36	FILM
37	M	38	LP
39	N/C	40	ENAVEE

**Note:** The model number of the CN18 socket is DF13A-40DP-1.25V (Hirose Electric Co., Ltd.)

## C.18 36-bit LCD display connector (CN9)

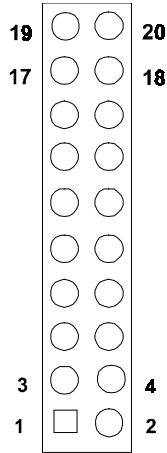

Table C-19: 36-bit LCD display connector (CN9)

Pin	Signal	Pin	Signal
1	GND	2	GND
3	P24	4	P25
5	P26	6	P27
7	P28	8	P29
9	P30	10	P31
11	P32	12	P33
13	P34	14	P35
15	GND	16	GND
17	N/C	18	N/C
19	N/C	20	N/C

**Note:** The model number of the CN19 socket is DF13A-20DP-1.25V (Hirose Electric Co., Ltd.)

## C.19 Peripheral power connector (CN26)

---

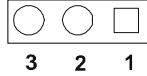

---

Table C-20: Peripheral power connector (CN26)

---

Pin	Function
1	-5 V
2	GND
3	-12 V

---

## C.20 CompactFlash™ card connector (CN30)

---

---

Table C-21: CompactFlash Card Connector (CN30)

---

Pin	Signal	Pin	Signal
1	GND	2	D03
3	D04	4	D05
5	D06	6	D07
7	*CS0	8	A10
9	*ATA SEL	10	A09
11	A08	12	A07
13	+5 V	14	A06
15	A05	16	A04

---

17	A03	18	A02
19	A01	20	A00
21	D00	22	D01
23	D02	24	-IOCS16
25	*CD2	26	-CD1
27	D11	28	D12
29	D13	30	D14
31	D15	32	-CS1
33	*VS1	34	-IORD
35	*IOWR	36	-WE
37	INTRQ	38	+5 V
39	*CSEL	40	-VS2
41	*RESER	42	IORDY
43	*INPACK	44	-REG
45	*DASP	46	-PDIAG
47	D08	48	D09
49	D10	50	GND

\* low active

## C.21 ATX power feature connector (CN5)

Table C-22: ATX power feature connector (CN5)

Pin	Signal
1	5VSB (Stand by voltage)
2	GND
3	PS. ON#

## C.22 Digital I/O (CN23)

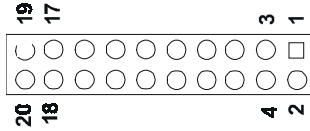

Table C-23: Digital I/O (CN23)

Pin	Pin
1 D00	2 D01
3 D02	4 D03
5 D04	6 D05
7 D06	8 D07
9 GND	10 GND
11 DI0	12 DI1
13 DI2	14 DI3
15 DI4	16 DI5
17 DI6	18 DI7
19 GND	20 GND

## C.23 Isolated 2 Digital Out (CN28)

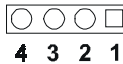

Table C-24: Isolated Digital Out (CN28)

Pin	Pin
1. VI00	3. VI01
2. D00	4. D01

## C.24 COM port connector (CN20)

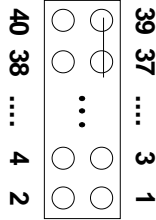

Table C-25: COM port connector (CN20)

Pin	Signal	Pin	Signal
1	RLSD1	2	DSR1
3	RX1	4	RTS1
5	TX1	6	CTS1
7	DTR1	8	RI1
9	GND	10	NC
11	RLSD2	12	DSR2
13	RX2	14	RTS2
15	TX2	16	CTS2
17	DTR2	18	RI2
19	GND	20	NC
21	RLSD3	22	DSR3
23	RX3	24	RTS3
25	TX3	26	CTS3
27	DTR3	28	RI3
29	GND	30	NC
31	RLSD4	32	DSR4
33	RX4	34	RTS4
35	TX4	36	CTS4
37	DTR4	38	RI4
39	GND	40	NC

APPENDIX

# D

## System Assignments

This appendix contains information of a detailed or specialized nature. It includes:

- System I/O ports
- 1st MB memory map
- DMA channel assignments
- Interrupt assignments

## D.1 System I/O ports

Table D-1: System I/O ports

<b>Addr. range (Hex)</b>	<b>Device</b>
000-01F	DMA controller
020-021	Interrupt controller 1, master
022-023	Chipset address
040-05F	8254 timer
060-06F	8042 (keyboard controller)
070-07F	Real-time clock, non-maskable interrupt (NMI) mask
080-09F	DMA page register
0A0-0BF	Interrupt controller 2
0C0-0DF	DMA controller
0F0	Clear math co-processor
0F1	Reset math co-processor
0F8-0FF	Math co-processor
1F0-1F8	Fixed disk
200-207	Reserved (Game I/O)
278-27F	Parallel printer port 2 (LPT 3)
2F8-2FF	Serial port 2
300-31F	Prototype card
360-36F	Reserved
378-37F	Parallel printer port 1 (LPT 2)
380-38F	SDLC, bisynchronous 2
3A0-3AF	Bisynchronous 1
3B0-3BF	Monochrome display and printer adapter (LPT1)
3C0-3CF	Reserved
3D0-3DF	Color/graphics monitor adapter
3F0-3F7	Diskette controller
3F8-3FF	Serial port 1

\* PNP audio I/O map range from 220 ~ 250H (16 bytes)  
MPU-401 select from 300 ~ 330H (2 bytes)

## D.2 1st MB memory map

---

Table D-2: 1st MB memory map

Addr. range (Hex)	Device
F000h - FFFFFh	System ROM
**DC000h - EFFFFh	Unused
*CC000h - DBFFFh	Ethernet ROM
C0000h - CBFFFh	Expansion ROM (for VGA BIOS)
B8000h - BFFFFh	CGA/EGA/VGA text
B0000h - B7FFFh	Unused
A0000h - AFFFFh	EGA/VGA graphics
00000h - 9FFFFh	Base memory

\* If Ethernet boot ROM is enabled

\*\* E0000 - EFFFF is reserved for Pentium® POST

## D.3 DMA channel assignments

---

Table D-3: DMA channel assignments

Channel	Function
0	Available
1	Available (audio)
2	Floppy disk (8-bit transfer)
3	Available (parallel port)
4	Cascade for DMA controller 1
5	Available
6	Available
7	Available

\* Audio DMA select 1, 3, or 5

\*\* Parallel port DMA select 1 (LPT2) or 3 (LPT1)

## D.4 Interrupt assignments

---

Table D-4: Interrupt assignments

<b>Interrupt#</b>	<b>Interrupt source</b>
IRQ 0	Interval timer
IRQ 1	Keyboard
IRQ 2	Interrupt from controller 2 (cascade)
IRQ 3	COM2
IRQ 4	COM1
IRQ 5	COM4/LPT2
IRQ 6	FDD
IRQ 7	LPT1
IRQ 8	RTC
IRQ 9	Reserved (audio)
IRQ 10	COM3
IRQ 11	Reserved for watchdog timer
IRQ 12	PS/2 mouse
IRQ 13	INT from co-processor
IRQ 14	Primary IDE
IRQ 15	Secondary IDE for CFC

\* Ethernet interface IRQ select: 9, 11, 15

\* PNP audio IRQ select: 9, 11, 15

\* PNP USB IRQ select: 9, 11, 15

APPENDIX

# E

## **Optional Extras for the PCM-9550F/FM/L**

## E.1 PCM-10586-5000/PCM-10586-5M00 cable kit for PCM-9550F and PCM-9550FM

The PCM-9550F/FM/L requires several cables for normal operation. You can make them yourself or purchase an optional cable kit assembly, which includes the following:

PCM-10586-5000 cable kit for PCM-9550 F PCM-10586-5M00 cable kit for PCM-9550 FM PCM-10586-5L00 cable kit for PCM-9550 L			
Part No.	Cable Description	PCM-9550 Connector	Terminating Connector
1701440350	2.5" and 1.8" IDE	CN17	44-pin, 2mm, female IDC (350mm)
1701440500	3.5" IDE	CN16	34-pin Dual Floppy
1701340603	Dual Floppy, 3.5" and 5.25" (34p)	CN19	34-pin Dual Floppy
1701260250	Parallel Port	CN21/22	25-pin female DSUB
1701100202	Network, 10-Base-T	CN6	RJ45 8-pin modular jack
1701160101	VGA CRT	CN1	2x8 pin header (2mm) 15-pin DSUB
1700000190	Keyboard and PS/2 mouse	CN10	5-pin circular DIN, 6-pin circular DIN
1703030300	Peripheral power (-5V and -12V)	CN26	(3-conductor)
1701080300	Front Panel	CN13	(8-conductor pigtail)
1701400181	COM 1-4 cable	CN20	40-pin, 9-pin male DSUB x4
1700160160*	Audio Cable	CN12	F3.5mm 16-pin, five female phone jacks
703140300 (for PCM-10586-5M00 only)	RCA Jack, S-video cable	CN 2	2 x 7 pin header, S-video RCA Jack

\* For PCM-10586-5000, PCM-10586-5M00 only

## E.2 Optional LCD cables for 9.4" MONO, 10.4" TFT LCD panel (CN14)

---

Optional LCD cables for 9.4" MONO, 10.4" TFT LCD panel

Part no.	Cable description	Panel type
1700090501	Cable DF9 (2 mm) 50 cm	Toshiba LTM10C042
1700090403	Cable DF9 (2 mm) 40 cm	Sharp LM64183P Sharp LM64P89
1703440151	Wire 30P/44P 15 cm	Toshiba LTM12C275A

## E.3 Optional USB cable (CN16)

---

Optional USB cable (2-channel)      Part no: 1703100260

## E.4 ATX Power Control Cable (CN5)

---

part no.:1703200100

## E.5 Optional PC/104+ to PCI Module

---

PCM-200-00A2                      PC/104+ to PCI Module

Note:

PCM-200-00A1 for PCM-9550 and PCM-9572 only;

PCM-200-00A2 for PCM-9550, PCM-9572, and PCM-9370

## E.6 Optional 24 bit LCD cable adaptor (5 V)

---

This converts the Hirose “DF20A” type connector to a 20 x 2- pin header. It supports 3.3 V or 5 V via pins 5 and 6.

part no: 9681000041 (for 5 V LCD panel)

part no: 9681000040 (for 3.3 V LCD panel)



APPENDIX

F

# Mechanical Drawings



# F.2 Solder side

