

## **PCA-6773**

**ISA Intel ULV400,650/LV800, 933  
Slot PC, CPU/VGA/LCD/LVDS/  
LAN/CFC and PC/104**

**User's Manual**

## Copyright

This document is copyrighted, © 2003. All rights are reserved. The original manufacturer reserves the right to make improvements to the products described in this manual at any time without notice.

No part of this manual may be reproduced, copied, translated or transmitted in any form or by any means without the prior written permission of the original manufacturer. Information provided in this manual is intended to be accurate and reliable. However, the original manufacturer assumes no responsibility for its use, nor for any infringements upon the rights of third parties that may result from such use.

## Acknowledgements

Award is a trademark of Award Software International, Inc.

VIA is a trademark of VIA Technologies, Inc.

IBM, PC/AT, PS/2 and VGA are trademarks of International Business Machines Corporation.

Intel and Pentium are trademarks of Intel Corporation.

Microsoft Windows® is a registered trademark of Microsoft Corp.

RTL is a trademark of Realtek Semi-Conductor Co., Ltd.

ESS is a trademark of ESS Technology, Inc.

UMC is a trademark of United Microelectronics Corporation.

SMI is a trademark of Silicon Motion, Inc.

Creative is a trademark of Creative Technology LTD.

All other product names or trademarks are properties of their respective owners.

For more information on this and other Advantech products, please visit our websites at: **<http://www.advantech.com>**

**<http://www.advantech.com/epc>**

For technical support and service, please visit our support website at:

**<http://service.advantech.com.tw/eservice/>**

This manual is for the PCA-6773.

Part No.200K677310

2 nd Edition, Nov, 2004

## **Packing List**

---

Before you begin installing your card, please make sure that the following materials have been shipped:

- 1 PCA-6773 all-in one single board computer
- 1 startup manual
- 1 CD-ROM or disks for utility, drivers, and manual (in PDF format)
- 1 power cable p/n:1703080101
- 1 PS/2 KB/M cable p/n:1700060202
- 1 COM port cable p/n:1701140201
- 1 FDD cable p/n:1701340705
- 1 EIDE cable p/n:170140060A
- Mini Jumper p/n:1653302122

If any of these items are missing or damaged, contact your distributor or sales representative immediately.

Optional Item:

1703100260 USB cable adapter(2.00mm)

## Model No. List

## Description

PCA-6773F-J0A1	ISA Celeron ULV400 Slot PC VGA/LCD/LVDS/LAN/CFC/PC104
PCA-6773-M0A1	ISA Celeron ULV650 Slot PC VGA/LCD/LVDS/LAN/CFC/PC104
PCA-6773-R0A1	ISA Intel LV933 Slot PC VGA/LCD/LVDS/2LAN/CFC/PC104

## **Additional Information and Assistance**

---

Visit the Advantech web site at **[www.advantech.com](http://www.advantech.com)** where you can find the latest information about the product.

Step 1. Contact your distributor, sales representative, or Advantech's customer service center for technical support if you need additional assistance. Please have the following information ready before you call:

- Product name and serial number
- Description of your peripheral attachments
- Description of your software (operating system, version, application software, etc.)
- A complete description of the problem
- The exact wording of any error messages

# FCC

*This device complies with the requirements in part 15 of the FCC rules: Operation is subject to the following two conditions:*

- 1. This device may not cause harmful interference, and*
- 2. This device must accept any interference received, including interference that may cause undesired operation*

*This equipment has been tested and found to comply with the limits for a Class A digital device, pursuant to Part 15 of the FCC Rules. These limits are designed to provide reasonable protection against harmful interference when the equipment is operated in a commercial environment. This equipment generates, uses, and can radiate radio frequency energy and, if not installed and used in accordance with the instruction manual, may cause harmful interference to radio communications. Operation of this device in a residential area is likely to cause harmful interference in which case the user will be required to correct the interference at his/her own expense. The user is advised that any equipment changes or modifications not expressly approved by the party responsible for compliance would void the compliance to FCC regulations and therefore, the user's authority to operate the equipment.*

## Caution!



## Achtung!

*There is a danger of a new battery exploding if it is incorrectly installed. Do not attempt to recharge, force open, or heat the battery.*

*Replace the battery only with the same or equivalent type recommended by the manufacturer. Discard used batteries according to the manufacturer's instructions.*



# Contents

<b>Chapter</b>	<b>1</b>	<b>General Information .....</b>	<b>1</b>
	1.1	Introduction .....	2
	1.2	Features .....	2
	1.3	Specifications .....	3
	1.4	Board layout: dimensions .....	5
<b>Chapter</b>	<b>2</b>	<b>Installation .....</b>	<b>7</b>
	2.1	Jumpers.....	8
	2.2	Connectors.....	8
	2.3	Locating Connectors(component side).....	10
	2.4	Locating Connectors(solder side).....	11
	2.5	Setting Jumpers .....	12
	2.6	Clear CMOS (JP1) .....	13
	2.7	RS232/422/485 Select(J1).....	14
	2.8	Watchdog timer configuration .....	14
	2.9	Installing DIMMs.....	15
	2.10	ATX power control connector (CN24) .....	15
	2.11	Printer port connector (CN5).....	16
	2.12	CompactFlash Card Connector .....	16
	2.13	Floppy drive connector (CN4) .....	16
	2.14	Primary IDE connector(CN3) .....	17
	2.15	VGA/LCD interface connections .....	18
	2.16	USB connectors (CN9,CN25).....	19
	2.17	Ethernet configuration.....	20
	2.18	Power connectors (CN19, FAN1) .....	20
	2.19	HDD ,PWR LED Connector & WDT output(CN6) .....	20
	2.20	COM port connector (CN20,CN21).....	21
	2.21	Keyboard and PS/2 mouse connector (CN26) .....	21
	2.22	External KB/Mouse Connector(CN23).....	21
	2.23	Audio AC97 interface(CN12) .....	21
	2.24	IR Connector(CN13).....	21
<b>Chapter</b>	<b>3</b>	<b>Software Configuration .....</b>	<b>23</b>
	3.1	Introduction .....	24
	3.2	VGA display firmware configuration .....	24
		Figure 3.1:VGA setup screen.....	25
<b>Chapter</b>	<b>4</b>	<b>PCI SVGA Setup .....</b>	<b>27</b>
	4.1	Introduction .....	28
	4.1.1	Chipset .....	28
	4.1.2	Display memory.....	28

	4.1.3	Display types.....	28
4.2		Installation of the SVGA Driver .....	29
	4.2.1	Installation for Windows 95 .....	29
	4.2.2	Installation for Windows 98/Me.....	33
	4.2.3	Installation for Windows NT .....	38
	4.2.4	Installation for Windows 2000 .....	43
	4.2.5	Installation for Windows XP .....	48
4.3		Further Information .....	54
<b>Chapter 5</b>		<b>PCI Bus Ethernet Interface.....</b>	<b>55</b>
5.1		Introduction .....	56
5.2		Installation of Ethernet driver .....	56
	5.2.1	Installation for MS-DOS and Windows 3.1.....	56
	5.2.2	Installation for Windows 98 .....	56
	5.2.3	Installation for Windows 2000 .....	60
	5.2.4	Installation for Windows NT .....	65
5.3		Further information .....	71
<b>Chapter 6</b>		<b>Award BIOS Setup.....</b>	<b>73</b>
6.1		System test and initialization.....	74
	6.1.1	System configuration verification.....	74
6.2		Award BIOS setup .....	75
	6.2.1	Entering setup .....	75
		Figure 6.1:BIOS setup program initial screen .....	75
	6.2.2	Standard CMOS Features setup.....	76
		Figure 6.2:CMOS Features setup.....	76
	6.2.3	Advanced BIOS Features setup .....	77
		Figure 6.3:Advanced BIOS Features setup.....	77
	6.2.4	Advanced Chipset Features setup.....	78
		Figure 6.4:Advanced Chipset Features setup .....	78
	6.2.5	Integrated Peripherals .....	79
		Figure 6.5:Integrated Peripherals.....	79
	6.2.6	Power Management Setup .....	79
		Figure 6.6:Power Management Setup.....	79
	6.2.7	PnP/PCI Configurations.....	80
		Figure 6.7:PnP/PCI Configurations .....	80
	6.2.8	PC Health Status .....	80
		Figure 6.8:PC Health Status.....	80
	6.2.9	Frequency/Voltage Control.....	81
		Figure 6.9:Frequency/Voltage Control .....	81
	6.2.10	Load Optimized Defaults.....	82
		Figure 6.10:Load BIOS defaults screen.....	82
	6.2.11	Set Password.....	82
		Figure 6.11:Set password.....	83
	6.2.12	Save & Exit Setup.....	84
		Figure 6.12:Save to CMOS and EXIT.....	84



	6.2.13	Exit Without Saving.....	85
		Figure 6.13:Quit without saving.....	85
<b>Appendix A</b>		<b>Programming the Watchdog Timer .....</b>	<b>87</b>
	A.1	Supported Input Timing Modes .....	88
<b>Appendix B</b>		<b>Installing PC/104 Modules .....</b>	<b>91</b>
	B.1	Installing PC/104 Modules.....	92
<b>Appendix C</b>		<b>Pin Assignments .....</b>	<b>95</b>
	C.1	ATX suspend power connector (CN24).....	96
	C.2	Floppy connector (CN4).....	97
	C.3	Primary IDE Connector (CN3) .....	98
	C.4	CompactFlash connector(CN28).....	99
	C.5	LAN,RJ45 connector(CN18) .....	100
	C.6	USB1, 2 connector(CN25) .....	100
	C.7	USB 3, 4 connector(CN9) .....	101
	C.8	IR connector(CN13).....	101
	C.9	LCD INV power connector(CN8).....	102
	C.10	LCD Backlight connector(CN7) .....	102
	C.11	DIO connector(CN15).....	103
	C.12	HDD, PWR LED connector & WDT output( CN6) .....	103
	C.13	LVDS connector(CN10) .....	104
	C.14	LPT connector(CN5).....	105
	C.15	Extension Panel Connector (CN11) .....	106
	C.16	COM 1, 2 Connector (CN21, CN20) .....	106
	C.17	Audio I/F connector(CN12) .....	107
	C.18	D-SUB VGA connector(CN16) .....	107
	C.19	Negative power input connector(CN22) .....	108
	C.20	Keyboard and Mouse connector(CN26) .....	108
	C.21	EXT_KB/Mouse connector(CN23).....	109
	C.22	Main power connector (CN19) .....	109
	C.23	LCD connector(CN14).....	110
	C.24	PWR_SW connector(CN1) .....	111
	C.25	Reset connector(CN2) .....	111
	C.26	CPU Fan connector (FAN1).....	111
<b>Appendix D</b>		<b>System Assignments .....</b>	<b>113</b>
	D.1	System I/O Ports.....	114
		Table D.1 System I/O ports .....	114
	D.2	1st MB memory map.....	115
		Table D.2 1st MB memory map.....	115
	D.3	DMA channel assignments.....	115
		Table D.3 DMA channel assignments .....	115
	D.4	Interrupt assignments .....	116

Table D.4 Interrupt assignments..... 116

## **General Information**

This chapter gives background information on the PCA-6773.

Sections include:

- Introduction
- Features
- Specifications
- Board layout and dimensions

# Chapter 1 General Information

## 1.1 Introduction

---

PCA-6773 is a new standard ISA bus Half-sized SBC. With an Onboard Intel ULV Celeron 400/650 Fanless CPU or LV Pentium III800(optional)/933MHz processor, along with a VIA VT8606/TwisterT + VT82C686B system chipset. The PCA-6773 support SDRAM up to 512MB, with an optional SODIMM then memory can support up to 1 GB.

Other on-board features include an EIDE, FDD, LPT, 4USBs, and 2 serial ports(RS-232 and RS-232/422/485). Watchdog timer & IrDA support, as well as a 10/100Mbps Ethernet is provided. The SSD solution supports Type I/II CompactFlash cards.

This product uses a VIA TwisterT chip with Integrated Savage4 2D/3D/Video Accelerator and supports 4X AGP VGA/LCD interface and up to 8/16/32 MB frame buffer using system memory. 9/12/18/24/36 bit TFT is also supported. PCA-6773 supports AC97 audio with the addition of the optional PCM-231A-00A1 audio module.

Its dimension is follow standard ISA slot PC, this make it can match with all half-sized chassis and can operate in high vibration environment.

## 1.2 Features

---

- Intel ULV 400, 650/LV800(optional), 933 MHz CPU on-board
- On board PCI SVGA VGA/LCD display
- 4X AGP graphics for high performance applications
- Low power consumption, requires no CPU cooling fan(ULV400,650)
- 10/100 Mbps Ethernet
- Supports boot from USB device
- Supports wake-on-LAN
- Supports Ring-up by Modem
- Supports LCD backlight turn-off function
- RS-485 Auto-flow

## 1.3 Specifications

---

### 1.3.1 Standard SBC Functions

- **CPU:** On board Intel ULV 400,650/LV800(optional), 933 MHz CPU
- **System chipsets:** VIA VT8606"TwisterT"+VT82C686B
- **BIOS:** Award 256 KB Flash memory
- **System memory:** SDRAM SODIMMx1, MAX:512MB(optional: SODIMMx2, up to 1GB)
- **2nd cache memory:** Celeron ULV 400, 650: 256K  
P-III LV 800, 933: 512K
- **SSD:** Support CompactFlash, Card Type I/II
- **Watchdog Timer:** 1~62 Sec, System reset or IRQ11
- **Expansion Interface:** 1x16-bit ISA Slot, 1x PC/104 connector
- **Battery:** Lithium 3/V/196 mAH
- **Serial ports:** Two serial RS-232 ports  
COM1: RS-232 COM2: RS-232/422/485  
RS-485 supports AUTO-flow
- **USB:** 4 USB ports, USB 1.1 compliant

### 1.3.2 VGA/LCD Interface

- **Chipset:** VIA VT8606"TwisterT" chip with integrated Savage4 2D/3D/Video Accelerator
- **Frame buffer:** Supports 8/16/32MB frame buffer with system memory
- **Interface:** 4X AGP VGA/LCD interface, Support up to 36 bit TFT
- **Display modes:**
  - CRT Modes: 1280 x 1024@16bpp (60Hz),  
1024 x 768@16bpp (85Hz);  
800x600@16bpp(60Hz)
  - LCD/Simulaneous Modes:  
1280 x1024@16bpp (60Hz).  
1024 x 768@16bpp (60Hz))

### 1.3.3 Solid State disk

- Supports CompactFlash Type I/II disks

### 1.3.4 PCI bus Ethernet interface

- **Chipset:** Intel 82551ER, 82551QM(optional),RealTek 8139C(optional)
- **Connection:** on-board RJ-45
- **BootROM:** build-in-system
- I/O address switchless setting

### 1.3.5 Mechanical and Environmental

- **Dimensions (L x W):** 185 x 122 mm(7.3" x 4.8")
- **Power supply voltage:** +5 V $\pm$ 5%, +12V  $\pm$ 5%
- **Power requirements:**

**Max:**

5A @+5V, 201mA @+12V (with 128MB SDRAM, Intel ULV-400 MHz CPU)

**Typical:**

2.55 A @ +5V, 48 mA@ +12V(with 128MB SDRAM, Intel ULV-400 MHz CPU)

- **Operating temperature:** 0 ~ 60°C (32 ~ 140°F),operation
- **Operating humidity:** 0% ~ 90% Relative Humidity, Non condensing

# 1.4 Board layout: dimensions

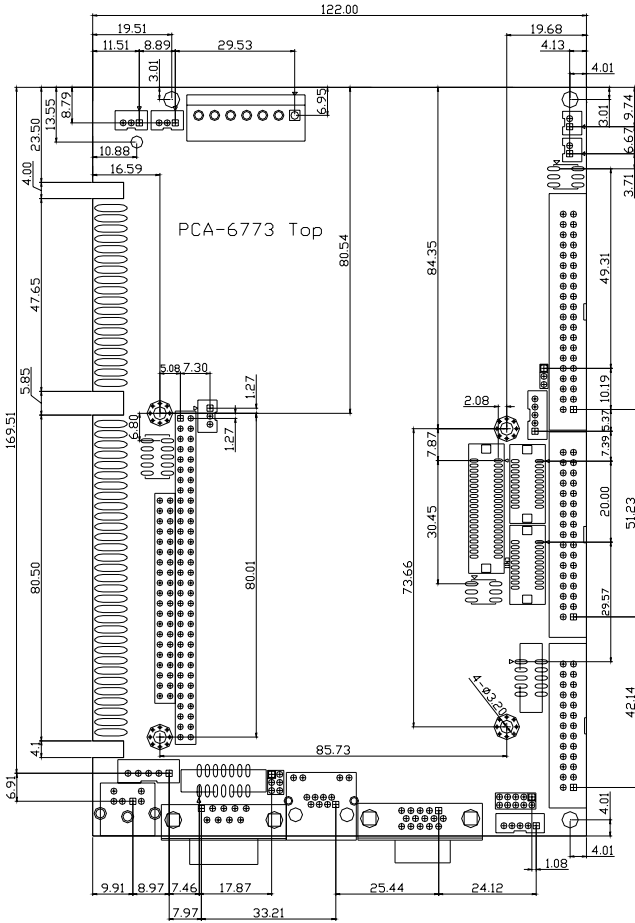
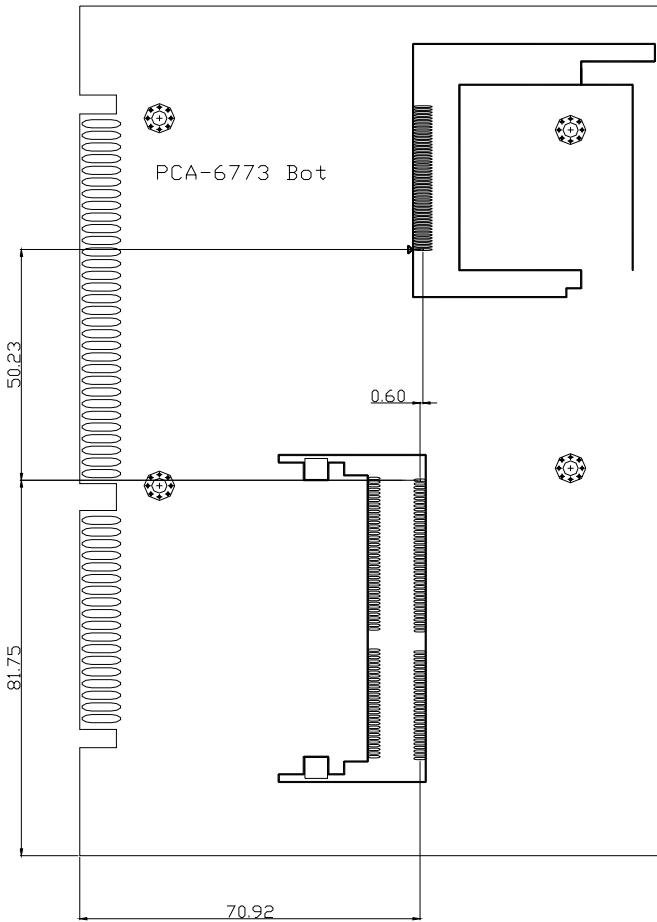

Figure 1.1: Board layout: dimensions (component side)



**Figure 1.2: Board layout: dimensions (solder side)**



# CHAPTER 2

## Installation

This chapter explains the setup procedures of PCA-6773 hardware, including instructions on setting jumpers and connecting peripherals, switches and indicators. Be sure to read all safety precautions before you begin the installation procedure.

# Chapter 2 Installation

## 2.1 Jumpers

---

The PCA-6773 has a number of jumpers that allow you to configure your system to suit your application. The table below lists the functions of the various jumpers.

---

*Table 2.1: Jumpers*

---

<b>Label</b>	<b>Function</b>
JP1	CMOS clear
JP2	Watchdog timer output selection
J1	RS232/422/485 Select

---

## 2.2 Connectors

---

On-board connectors link the PCA-6773 to external devices such as hard disk drives, a keyboard, or floppy drives. The table below lists the function of each of the board's connectors.

---

*Table 2.2: Connectors*

---

<b>Label</b>	<b>Function</b>
CN1	PWR_SW connector
CN2	Reset connector
CN3	Primary IDE connector
CN4	Floppy connector
CN5	LPT connector
CN6	HDD,PWR LED connector&WDT output
CN7	LCD backlight connector
CN8	LCD INV PWR connector
CN9	USB 3,4 connector

---

***Table 2.2: Connectors***

CN10	LVDS connector
CN11	LCD connector
CN12	Audio I/F connector
CN13	IR connector
CN14	LCD connector1
CN15	DIO connector
CN16	D-SUB VGA connector
CN17	PC/104
CN18	LAN connector
CN19	Main power connector
CN20	COM2
CN21	COM1
CN22	Negative power input connector(optional)
CN23	EXT_KB connector
CN24	ATX suspend power connector
CN25	USB 1,2 connector
CN26	Keyboard/Mouse connector
CN28	CF connector

## 2.3 Locating Connectors(component side)

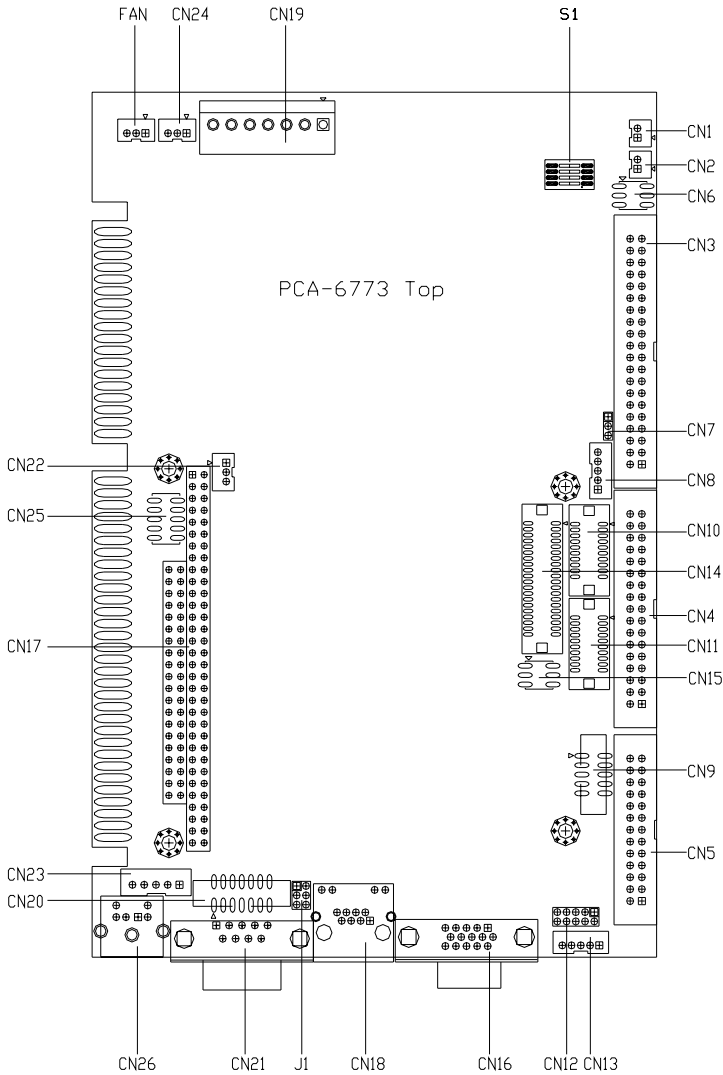

**Figure 2.1: Jumper & Connector Locations**

## 2.4 Locating Connectors(solder side)

---

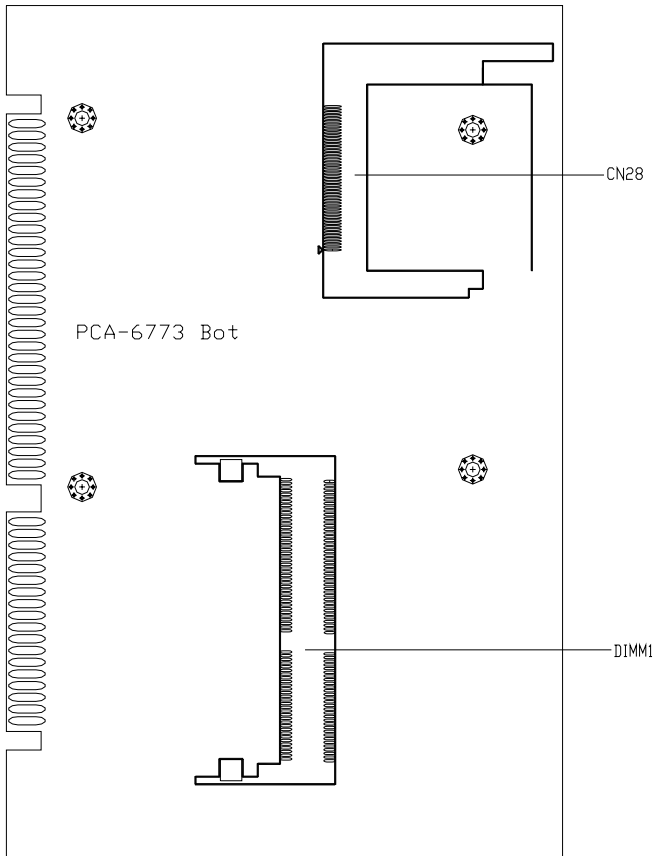
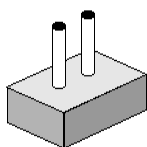

*Figure 2.2: Connectors (component side)*

## 2.5 Setting Jumpers

---

You may configure your card to match the needs of your application by setting jumpers. A jumper is a metal bridge used to close an electric circuit. It consists of two metal pins and a small metal clip (often protected by a plastic cover) that slides over the pins to connect them. To “close” a jumper, you connect the pins with the clip. To “open” a jumper, you remove the clip. Sometimes a jumper will have three pins, labeled 1, 2 and 3. In this case you would connect either pins 1 and 2, or 2 and 3.



open

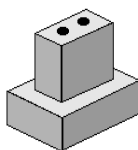

closed

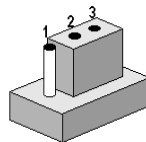

closed 2-3

The jumper settings are schematically depicted in this manual as follows:

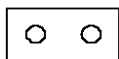

open



closed

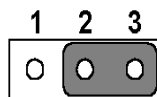

closed 2-3

A pair of needle-nose pliers may be helpful when working with jumpers.

If you have any doubts about the best hardware configuration for your application, contact your local distributor or sales representative before you make any changes.

Generally, you simply need a standard cable to make most connections.

## 2.6 Clear CMOS (JP1)

---

**Warning!** To avoid damaging the computer, always turn off the power supply before setting “Clear CMOS.” Before turning on the power supply, set the jumper back to “3.0 V Battery On.”

This jumper is used to erase CMOS data and reset system BIOS information.



The procedure for clearing CMOS is:

1. Turn off the system.
2. Short pin 2 and pin 3.
3. Return jumper to pins 1 and 2.
4. Turn on the system. The BIOS is now reset to its default setting

---

**Table 2.3: CMOS clear (JP1)**

---

*3.0 V normal			clear CMOS		
1	2	3	1	2	3
					

---

\* default setting

## 2.7 RS232/422/485 Select(J1)

---

*Table 2.4: RS232/422/485 Select*

PIN	RS232	RS422	RS485
1-2	Closed	Open	Open
3-4	Open	Closed	Open
5-6	Open	Open	Closed

## 2.8 Watchdog timer configuration

---

An on-board watchdog timer reduces the chance of disruptions which EMP (electro-magnetic pulse) interference can cause. This is an invaluable protective device for standalone or unmanned applications. Setup involves one jumper and running the control software (refer to Appendix A).

### 2.8.1 Watchdog timer action (JP2)

When the watchdog timer activates (CPU processing has come to a halt), it can reset the system or generate an interrupt on IRQ11. This can be set via setting JP2 as shown below:

*Table 2.5: Watchdog timer action (JP2)*

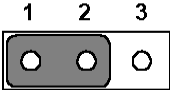
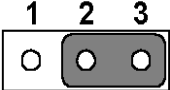
*System reset	IRQ 11
	

\* default setting



## 2.9 Installing DIMMs

---

The procedure for installing DIMMs is described below. Please follow these steps carefully. The number of pins are different on either side of the breaks, so the module can only fit in one way. DIMM modules have different pin contacts on each side, and therefore have a higher pin density.

1. Make sure that the two handles of the DIMM socket are in the “open” position. i.e. The handles remain leaning outward.
2. Slowly slide the DIMM module along the plastic guides on both ends of the socket.
3. Press the DIMM module right down into the socket, until you hear a click. This is when the two handles have automatically locked the memory module into the correct position of the socket.

To **remove** the memory module, just push both handles outward, and the module will be ejected from the socket.

## 2.10 ATX power control connector (CN24)

---

### 2.10.1 ATX suspend power connector(CN24)

The PCA-6773 can support an advanced soft power switch function, if an ATX power supply is used. To enable the soft power switch function:

1. Get the specially designed ATX-to-EBX power cable
2. Connect the 3-pin plug of the cable to CN24 (ATX feature connector).
3. Connect the power on/off button to CN1. (A momentary type of button should be used.)

**Important** *Make sure that the ATX power supply can take at least a 10 mA load on the 5 V standby lead (5VSB). If not, you may have difficulty powering on your system.*

## 2.11 Printer port connector (CN5)

---

Normally, the parallel port is used to connect the card to a printer. The PCA-6773 includes a multi-mode (ECP/EPP/SPP) parallel port accessed via CN5 and a 26-pin flat-cable connector. You will need an adapter cable if you use a traditional DB-25 connector. The adapter cable has a 26-pin connector on one end, and a DB-25 connector on the other.

The parallel port is designated as LPT1, and can be disabled or changed to LPT2 or LPT3 in the system BIOS setup.

The parallel port interrupt channel is designated to be IRQ7.

You can select ECP/EPP DMA channel via BIOS setup.

## 2.12 CompactFlash Card Connector

---

The PCA-6773 provides a 50-pin socket for CompactFlash card type I/II.

### 2.12.1 CompactFlash(CN28)

The CompactFlash card occupies a secondary IDE channel which can be enabled/disabled via the BIOS settings.

## 2.13 Floppy drive connector (CN4)

---

You can attach up to two floppy drives to the PCA-6773's on-board controller. You can use any combination of 5.25" (360 KB and 1.2 MB) and/or 3.5" (720 KB, 1.44 MB, and 2.88 MB) drives.

A 34-pin daisy-chain drive connector cable is required for a dual-drive system. On one end of the cable is a 34-pin flat-cable connector. On the other end are two sets of floppy disk drive connectors. Each set consists of a 34-pin flat-cable connector (usually used for 3.5" drives) and a printed-circuit board connector (usually used for 5.25" drives).

### 2.13.1 Connecting the floppy drive

1. Plug the 34-pin flat-cable connector into CN4. Make sure that the red wire corresponds to pin one on the connector.
2. Attach the appropriate connector on the other end of the cable to the floppy drive(s). You can use only one connector in the set. The set on the end (after the twist in the cable) connects to the A: drive. The set in the middle connects to the B: drive.

3. If you are connecting a 5.25" floppy drive, line up the slot in the printed circuit board with the blocked-off part of the cable connector.

If you are connecting a 3.5" floppy drive, you may have trouble determining which pin is number one. Look for a number printed on the circuit board indicating pin number one. In addition, the connector on the floppy drive may have a slot. When the slot is up, pin number one should be on the right. Check the documentation that came with the drive for more information.

If you desire, connect the B: drive to the connectors in the middle of the cable as described above.

In case you need to make your own cable, you can find the pin assignments for the board's connector in Appendix C.

## **2.14 Primary IDE connector(CN3)**

---

The PCA-6773 provides an IDE channel to which you can attach up to two Enhanced Integrated Device Electronics hard disk drives or CDROM to the PCA-6773's internal controller. The PCA-6773's IDE controller uses a PCI interface. This advanced IDE controller supports faster data transfer, PIO Mode 3 or Mode 4, UDMA 33/66/100 mode.

### **2.14.1 Connecting the hard drive**

Connecting drives is done in a daisy-chain fashion. It requires one of two cables (not included in this package), depending on the drive size. 1.8" and 2.5" drives need a 1 x 44-pin to 2 x 44-pin flat-cable connector. 3.5" drives use a 1 x 44-pin to 2 x 40-pin connector.

Wire number 1 on the cable is red or blue, and the other wires are gray.

1. Connect one end of the cable to CN3. Make sure that the red (or blue) wire corresponds to pin 1 on the connector, which is labeled on the board (on the right side).
2. Plug the other end of the cable into the Enhanced IDE hard drive, with pin 1 on the cable corresponding to pin 1 on the hard drive. (See your hard drive's documentation for the location of the connector.)

If desired, connect a second drive as described above.

Unlike floppy drives, IDE hard drives can connect to either end of the cable. If you install two drives, you will need to set one as the master and one as the slave by using jumpers on the drives. If you install only one drive, set it as the master.

## 2.15 VGA/LCD interface connections

---

The PCA-6773's display interface can drive conventional CRT displays and is capable of driving a wide range of flat panel displays as well, including passive LCD and active LCD displays. The board has two display connectors: one for standard CRT VGA monitors, and one for flat panel displays.

### 2.15.1 CRT display connector (CN16)

CN16 is a standard 15-pin D-SUB connector commonly used for VGA.

Pin assignments for CRT display connector CN16 are detailed in Appendix C.

### 2.15.2 Flat panel display connector (CN14)

CN14 consists of a 40-pin connector which can support an 18-bit LCD panel. It is Hirose's product no. DF13A-40DP-1.25 V

The PCA-6773 provides a bias control signal on CN12 that can be used to control the LCD bias voltage. It is recommended that the LCD bias voltage not be applied to the panel until the logic supply voltage (+5 V or +3.3 V) and panel video signals are stable. Under normal operation, the control signal (ENAVEE) is active high. When the PCA-6773's power is applied, the control signal is low until just after the relevant flat panel signals are present.

### 2.15.3 Extension flat panel connector(CN11)

CN11 consists of a 20-pin connector which is Hirose's product no.DF13-20DP-1.25V. The PCA-6773 supports a 36-bit LCD panel which must be connected to both the CN14(40-pin) and CN11(20-pin). The pin assignments for both CN14 and CN11 can be found in Appendix C.

### 2.15.4 LVDS LCD panel connector(CN10)

The PCA-6773 uses the VIA "TwisterT" chip that supports 2 channel LVDS LCD panel displays. Users can connect to LVDS LCD with CN10.

### 2.15.5 LCD inverter connector(CN8)

The LCD inverter is connected to CN8 via a 5-pin connector to provide +12V power to the LCD display.

## 2.15.6 Panel type selection (S1)

S1 is an 8 segment DIP switch for DSTN/TFT panel type and resolution functions.

*Table 2.6: S1 Panel Type select*

SW 1-1	SW 1-2	SW 1-3	SW 1-4	Panel Type & Resolution		
ON	ON	ON	ON	TFT	640x480**	18bit (H. V. Freq)
ON	ON	ON	OFF	TFT	648x480	18bit (Synthetic)
ON	ON	OFF	ON	TFT	648x480**	N/A
ON	ON	OFF	OFF	TFT	648x480**	LVDS
ON	OFF	ON	ON	DSTN	648x480**	18bit
ON	OFF	ON	OFF	TFT	800x600**	18bit (H. V. Freq)
ON	OFF	OFF	ON	TFT	800x600	18bit (Synthetic)
ON	OFF	OFF	OFF	TFT	800x600**	LVDS
OFF	ON	ON	ON	TFT	800x600**	N/A
OFF	ON	ON	OFF	DSTN	800x600**	18bit
OFF	ON	OFF	ON	TFT	1024x768**	36bit (H. V. Freq)
OFF	ON	OFF	OFF	TFT	1024x768**	36bit (Synthetic)
OFF	OFF	ON	ON	TFT	1024x768**	LVDS
OFF	OFF	ON	OFF	TFT	1024x768**	N/A
OFF	OFF	OFF	ON	DSTN	1024x768**	18bit
OFF	OFF	OFF	OFF	DSTN	1024x768**	24bit

\* Default setting

\*\* will support in the future

## 2.16 USB connectors (CN9,CN25)

The PCA-6773 board provides up to four USB (Universal Serial Bus) ports. This gives complete Plug and Play, and hot attach/detach for up to **127** external devices. The USB interfaces comply with USB specification Rev. 1.1, and are fuse protected.

The USB interface is accessed through the 5 x 2-pin flat-cable connector, CN25 (USB1, 2),CN9(USB3, 4). You will need an adapter cable if you

use a standard USB connector. The adapter cable has a 5 x 2-pin connector on one end and a USB connector on the other.

The USB interfaces can be disabled in the system BIOS setup.

## **2.17 Ethernet configuration**

---

The PCA-6773 is equipped with a high performance 32-bit PCI-bus Ethernet interface which is fully compliant with IEEE 802.3U 10/100Mbps CSMA/CD standards. It is supported by all major network operating systems.

The PCA-6773 supports 3 10/100Mbps Ethernet connections with onboard RJ-45 connectors(CN18).

### **2.17.1 100Base-T connector (CN18)**

10/100Base-T connects to the PCA-6773 via an adapter cable to an 8-pin polarized header (CN18).

### **2.17.2 Network boot**

The Network Boot feature can be utilized by incorporating the Boot ROM image files for the appropriate network operating system. The Boot ROM BIOS files are included in the system BIOS, which is on the utility CD disc.

## **2.18 Power connectors (CN19, FAN1)**

---

### **2.18.1 Main power connector, +5 V, +12 V (CN19)**

Supplies main power to the PCA-6773 (+5 V), and to devices that require +12 V.

### **2.18.2 CPU Fan power supply connector (FAN1)**

Provides power supply to CPU cooling fan. Only present when +5 V power is supplied to the board.

## **2.19 HDD ,PWR LED Connector & WDT output(CN6)**

---

Next, you may want to install external switches to monitor and control the PCA-6773. These features are optional: install them only if you need them. CN6 is an 2x3 pin header, 180 degree, male. It provides connections for watchdog output and power & hard disk indicator.

## **2.20 COM port connector (CN20,CN21)**

---

The PCA-6773 provides two serial ports (COM1: RS-232 and COM2: RS232) in one COM port connector. It provides connections for serial devices (a mouse, etc.) or a communication network. You can find the pin assignments for the COM port connector in Appendix C.

## **2.21 Keyboard and PS/2 mouse connector (CN26)**

---

The PCA-6773 board provides a keyboard connector that supports both a keyboard and a PS/2 style mouse. In most cases, especially in embedded applications, a keyboard is not used. If the keyboard is not present, the standard PC/AT BIOS will report an error or fail during power-on self-test (POST) after a reset. The PCA-6773's BIOS standard setup menu allows you to select "All, But Keyboard" under the "Halt On" selection. This allows no-keyboard operation in embedded system applications, without the system halting under POST.

## **2.22 External KB/Mouse Connector(CN23)**

---

In addition to the PS/2 mouse/keyboard connector on the PCA-6773's rear plate, there is an additional onboard external keyboard connector, allowing for greater flexibility in system design.

## **2.23 Audio AC97 interface(CN12)**

---

The Audio AC97 link is a 10 pin connector, the PCA-6773 can support AC97 Audio with the addition of optional PCM-231A-00A1. Detailed pin assignment refer to Appendix C.

## **2.24 IR Connector(CN13)**

---

This connector supports the optional wireless infrared transmitting and receiving module. This module mounts on the system case. You must configure th setting through BIOS setup. Detailed pin definition you will find in Appendix C.





## Software Configuration

This chapter details the software configuration information. It shows you how to configure the card to match your application requirements. Award System BIOS will be covered in Chapter 4.

Sections include:

- Introduction
- VGA display software configuration

# Chapter 3 Software Configuration

## 3.1 Introduction

---

The system BIOS and custom drivers are located in a 256 KB, 32-pin (JEDEC spec.) Flash ROM device, designated U10. A single Flash chip holds the system BIOS, VGA BIOS, and network Boot ROM image. The display can be configured via software. This method minimizes the number of chips and eases configuration. You can change the display BIOS simply by reprogramming the Flash chip.

## 3.2 VGA display firmware configuration

---

The board's on-board VGA interface supports a wide range of popular LCD, EL, gas plasma flat panel displays and traditional analog CRT monitors. The optimized shared memory architecture supports an 8/16/32 MB frame buffer using system memory to provide resolutions of 1280 x 1024 @ 16 bpp, the interface can drive CRT displays with resolutions up to 1024 x 768 @ 16 bpp and 800 x 600 @ 16 bpp.

The VGA interface is configured completely via the software utility, so you do not have to set any jumpers. Configure the VGA display as follows:

1. Apply power to the board with a color TFT display attached. This is the default setting for this board. Ensure that the AWD-FLASH.EXE and \*.BIN files are located in the working drive.

**NOTE:**      *Ensure that you do not run AWDFLASH.EXE while your system is operating in EMM386 mode.*

2. At the prompt, type AWDFLASH.EXE and press <Enter>. The VGA configuration program will then display the following:

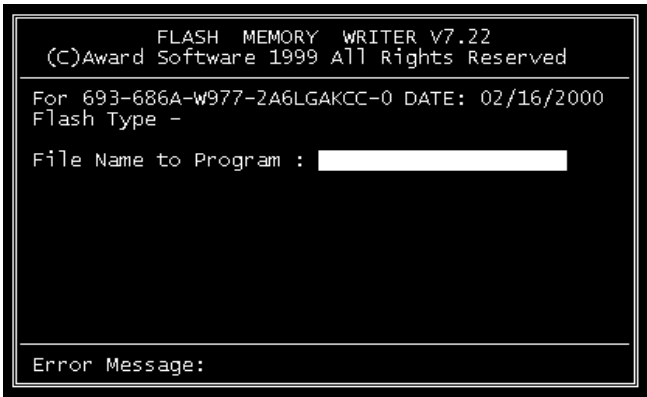

*Figure 3.1: VGA setup screen*

3. At the prompt, enter the new BIN file which supports your display. When you are sure that you have entered the file name correctly press <Enter>.
4. The screen will ask 'Do you want to save BIOS?'. If you change your mind or have made a mistake, press N to abort and end the setup procedure. Press Y if you wish to save the existing configuration before changing it. Then type the name under which you want to save the current configuration.
5. The prompt will then ask 'Are you sure to program?'. Press Y if you want the new file to be written into the BIOS. Press N to exit the program.

The new VGA configuration will then write to the ROM BIOS chip. This configuration will remain the same until you run the AWDFLASH.EXE program and change the settings.



## PCI SVGA Setup

Introduction

Installation of SVGA drivers

-for Windows 95/98/Me

-for Windows NT/2000/XP

Further information

# Chapter 4 PCI SVGA Setup

## 4.1 Introduction

---

The board has an onboard AGP flat panel/VGA interface. The specifications and features are described as follows:

### 4.1.1 Chipset

The board uses a VIA Twister 8606T chipset from VIA Technology Inc. for its AGP/SVGA controller. It supports many popular LCD, and LVDS LCD displays and conventional analog CRT monitors. The VIA8606T VGA BIOS supports color TFT and DSTN LCD flat panel displays. In addition, it also supports interlaced and non-interlaced analog monitors (color and monochrome VGA) in high-resolution modes while maintaining complete IBM VGA compatibility. Digital monitors (i.e. MDA, CGA, and EGA) are NOT supported. Multiple frequency (multisync) monitors are handled as if they were analog monitors.

### 4.1.2 Display memory

The Twister chip can support 8/16/32MB frame buffer shared with system memory; the VGA controller can drive CRT displays or color panel displays with resolutions up to 1280 x 1024 at 16 M colors.

### 4.1.3 Display types

CRT and panel displays can be used simultaneously. The board can be set in one of three configurations: on a CRT, on a flat panel display, or on both simultaneously. The system is initially set to simultaneous display mode. If you want to enable the CRT display only or the flat panel display only, please contact VIA Technology Inc., or our sales representative for detailed information.

## 4.2 Installation of the SVGA Driver

---

Complete the following steps to install the SVGA driver. Follow the procedures in the flow chart that apply to the operating system that you are using within your board.

- Notes:**
1. *The windows illustrations in this chapter are intended as examples only. Please follow the listed steps, and pay attention to the instructions which appear on your screen.*
  2. *For convenience, the CD-ROM drive is designated as "D" throughout this chapter.*

### 4.2.1 Installation for Windows 95

1. Select "Start", "Settings", "Control Panel", "Display", "Settings", and "Advanced Properties".

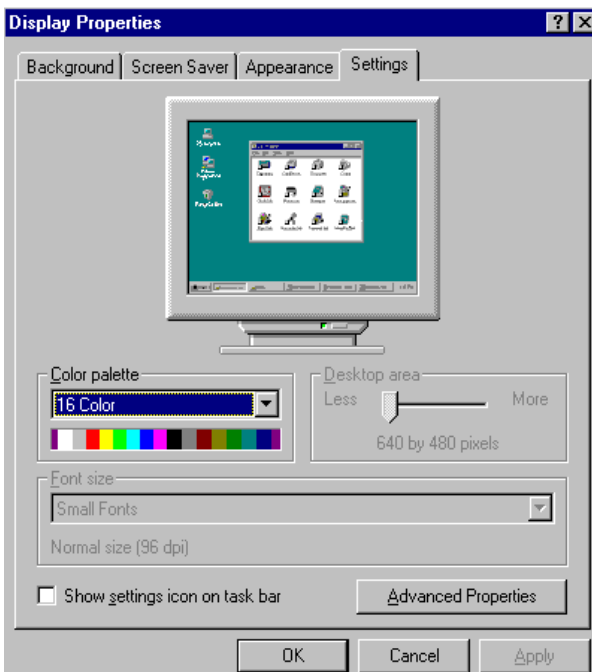

2. Choose the "Adapter" tab, then press the "Change..." button.

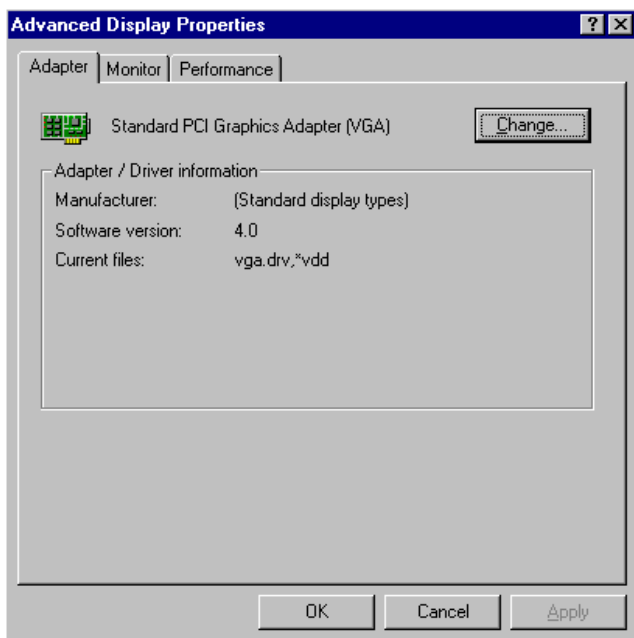

3. Press the "Have Disk" button.

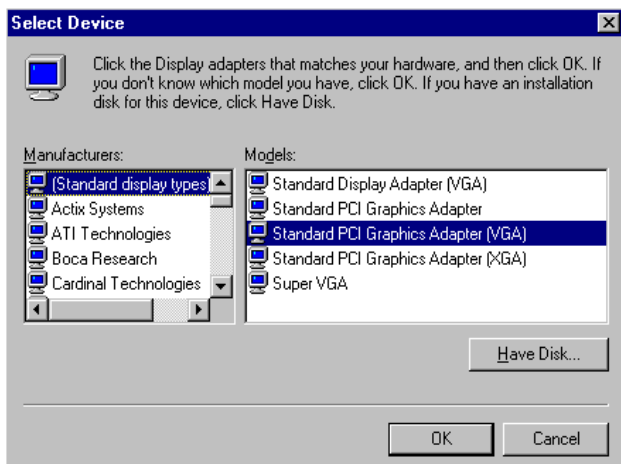



4. Type in the path:  
**D:\Biscuit\9577\VGA\Win9x\_Me**

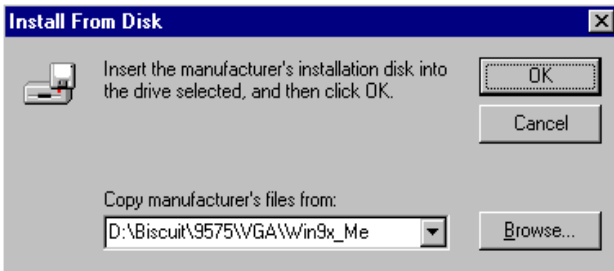

5. Select the highlighted item, and click the "OK" button.

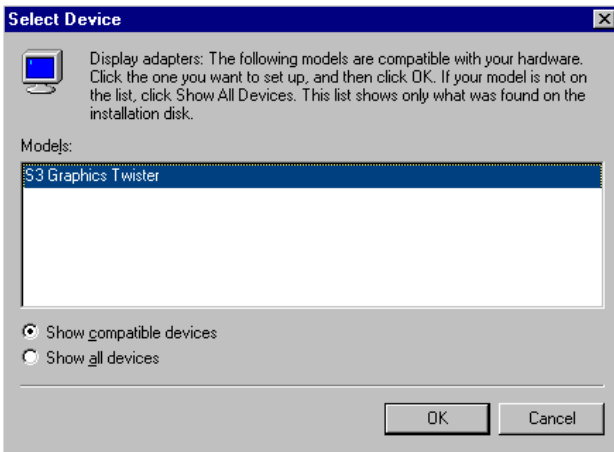

6. "S3 GraphicsTwister" appears under the adapter tab. Click the "Apply" button, then the "OK" button.

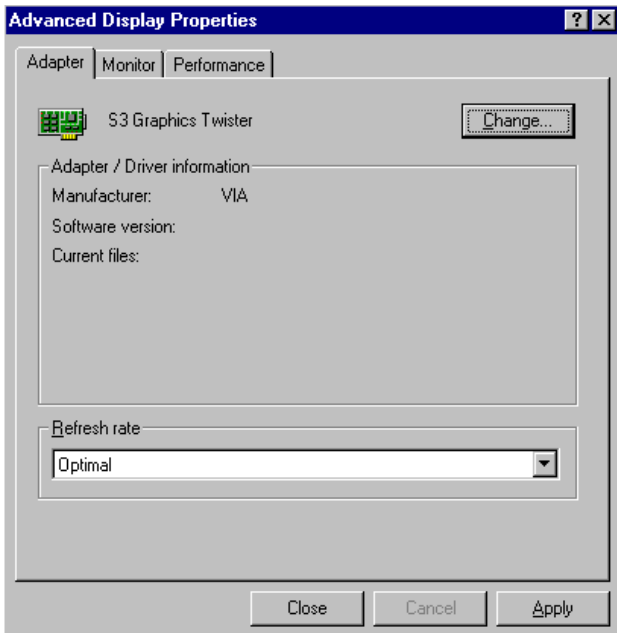

7. Press "Yes" to reboot.

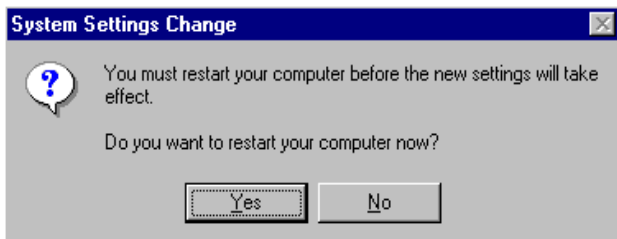

## 4.2.2 Installation for Windows 98/Me

1. Select "Start", "Settings", "Control Panel", "Display", and "Settings," then press the "Advanced..." button.

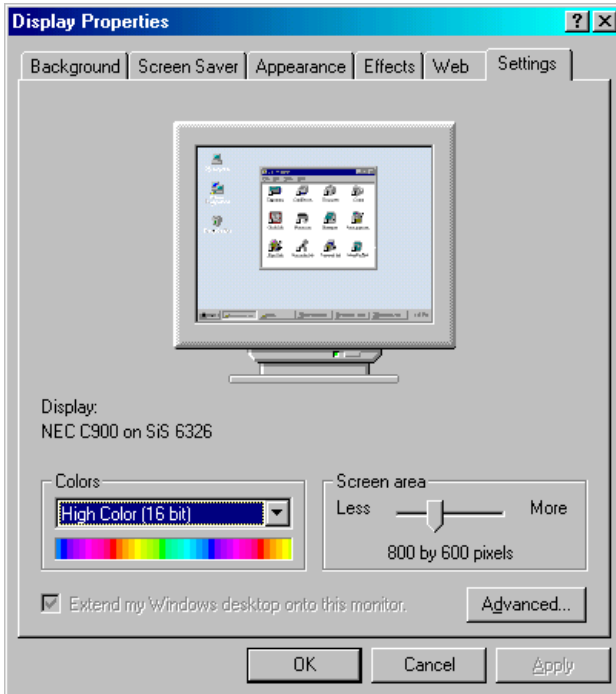

2. Select “Adapter,” then “Change.”

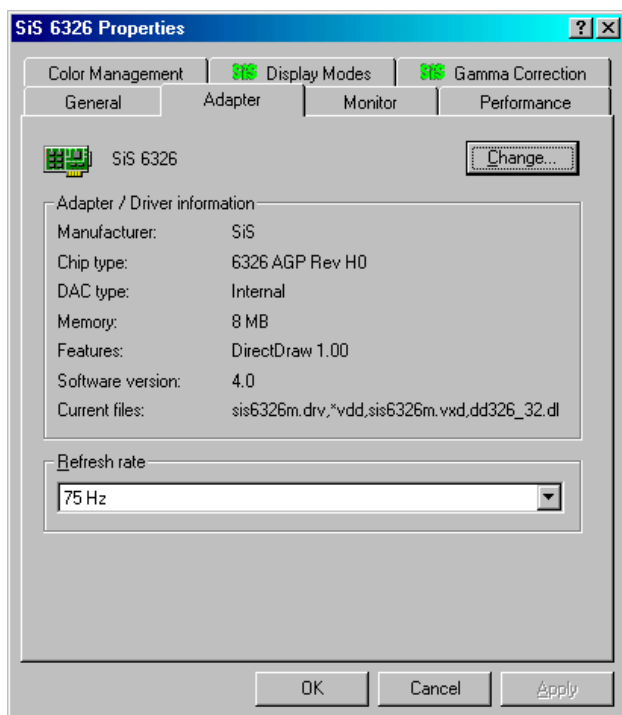

3. Press “Next,” then “Display a list....”

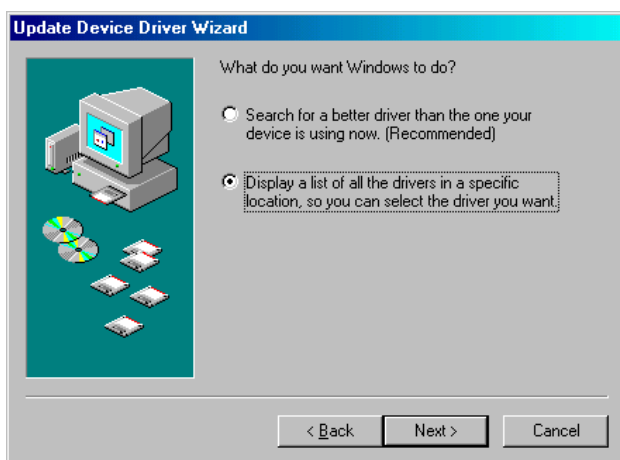

4. Press the “Have disk...” button.

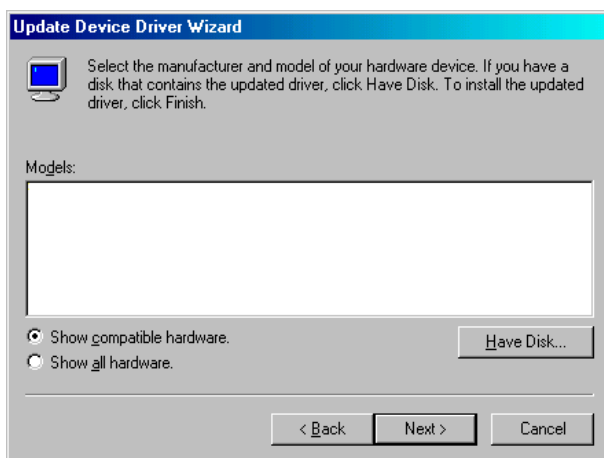

5. Insert the CD into the CD-ROM drive. Type in the path **D:\Biscuit\9577\VGA\Win9x\_Me**  
Then press “OK”



6. Select the highlighted item, then click “OK.”

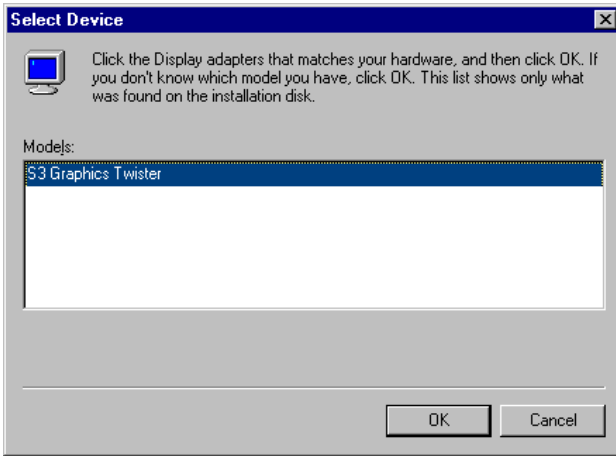

7. "S3 Graphics Twister" appears under the adapter tab. Click the "Apply" button.

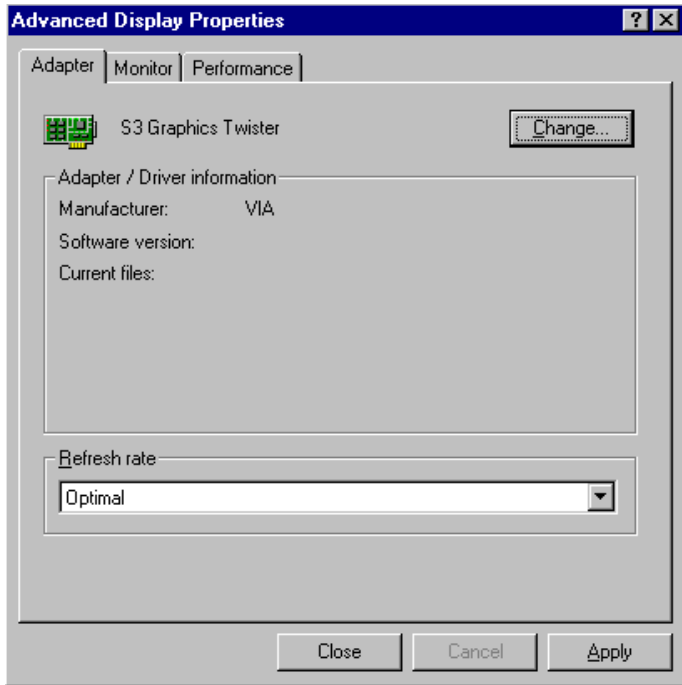

8. Press "Yes" to reboot.

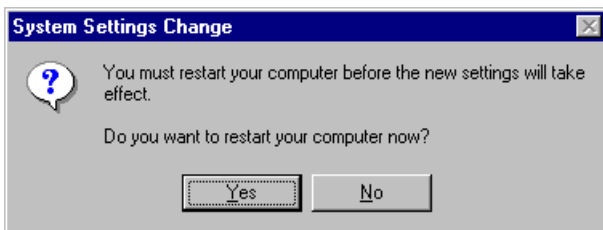

### 4.2.3 Installation for Windows NT

*Note:* Service Pack X (X = 3, 4, 5, 6,...) must be installed first, before you install the Windows NT VGA driver.

1. Select "Start", "Settings", "Control Panel" and double click the "Display" icon.

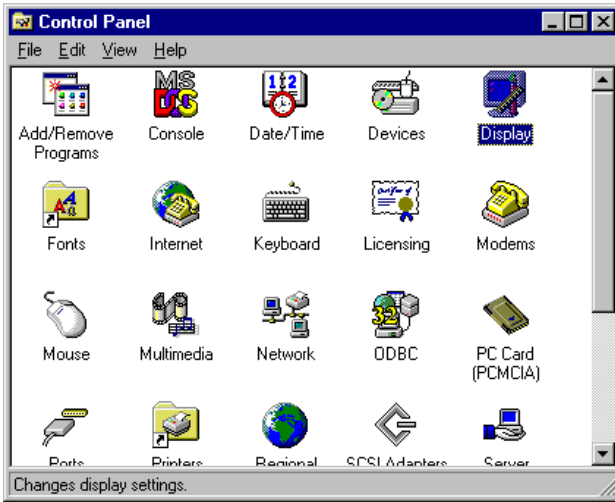



2. Choose the "Settings" tab, and press the "Display Type" button.

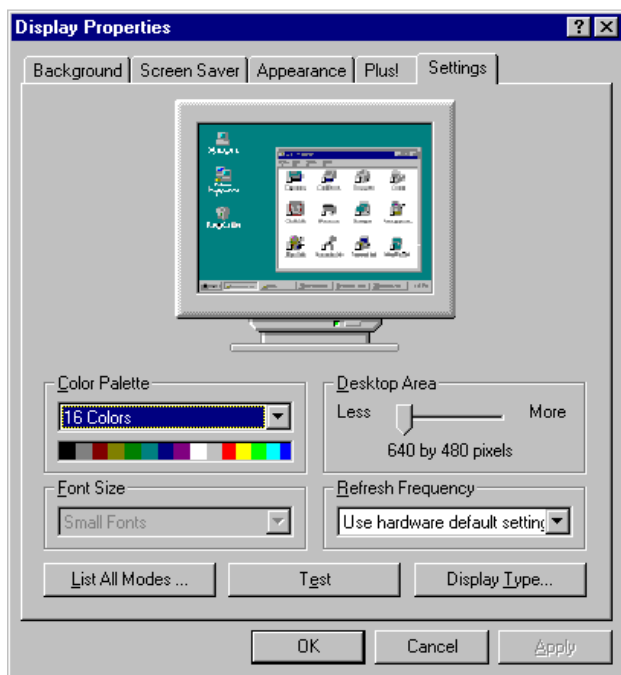

3. Press the "Change..." button.

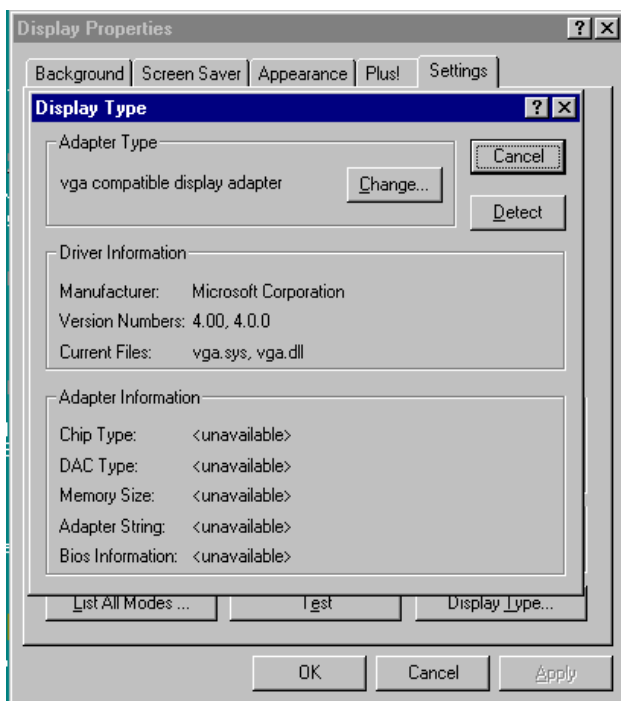

4. Click the "Have Disk..." button.

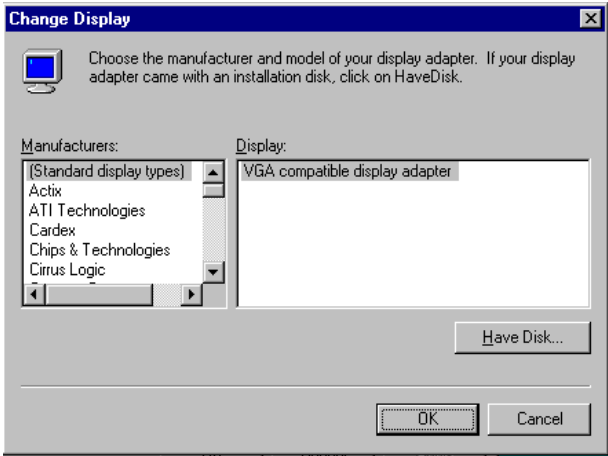

5. Type the path:  
**D:\Biscuit\VGA\WinNT**  
Press the "OK" button.

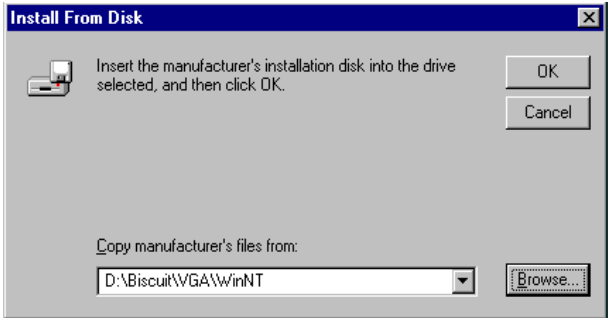

6. Select the highlighted item, and click the "OK" button.

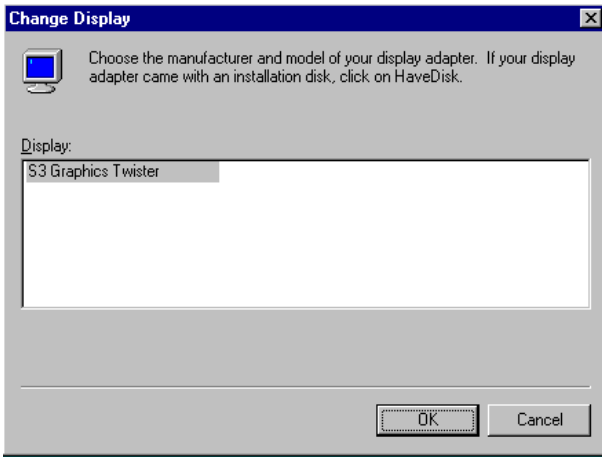

7. Press "Yes" to proceed.

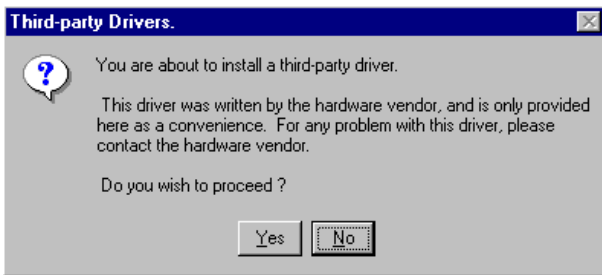

8. Press "OK" to reboot.

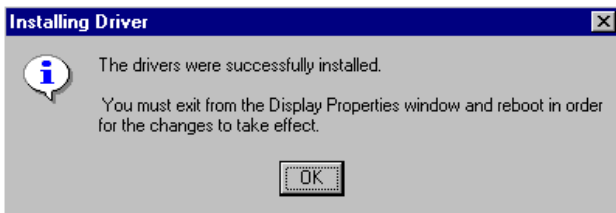

## 4.2.4 Installation for Windows 2000

1. Select "System", "Settings", "Control Panel" and double click the "system" icon.

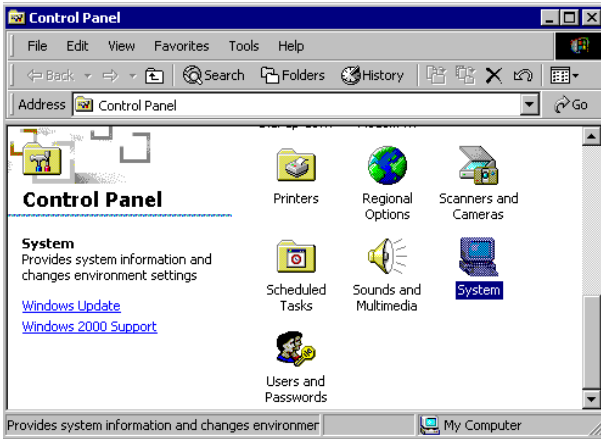

2. Choose the "Video Controller (VGA Compatible)" button.

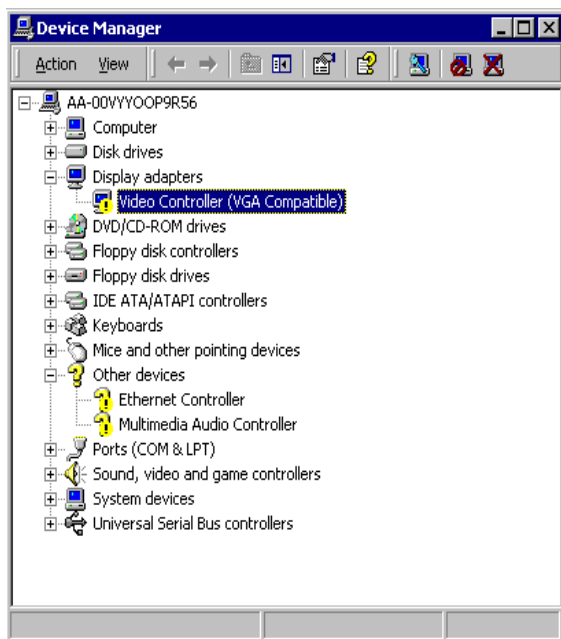

3. Choose the "Drive" button, press "Update Driver..." button.

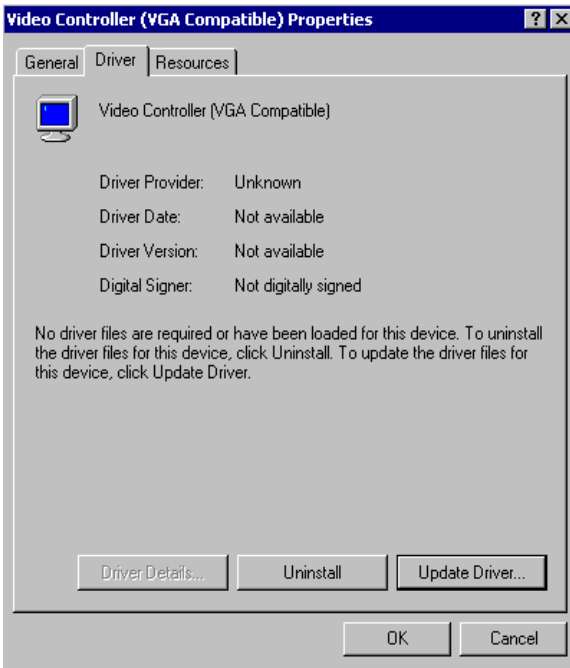

4. Choose "Display a list of..." , then press "Next" button.



5. Choose "Display adapters", press "Next" button.

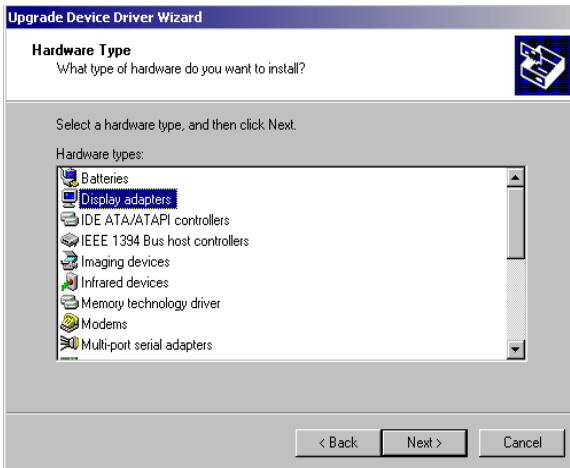



6. Click the “Have Disk” button.

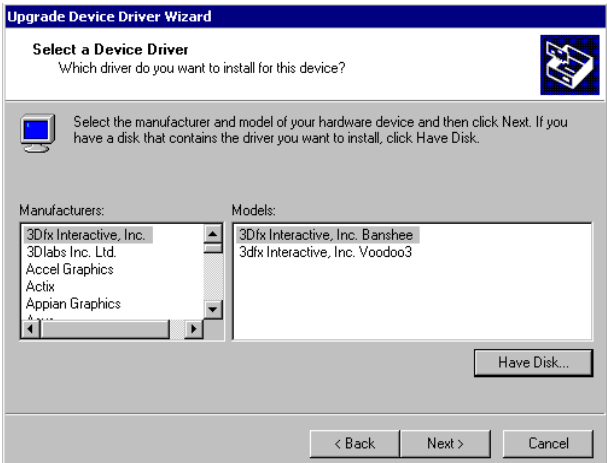

7. Type the path D:\Biscuit\9577\VGA\Win2000 press the “OK” button.

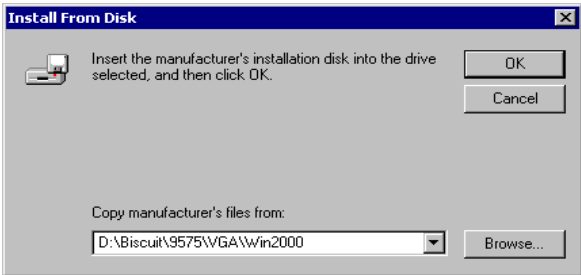

8. Press "Finish" to reboot.



#### 4.2.5 Installation for Windows XP

1. Select "System", "Settings", "Control Panel" and double click the "system" icon.

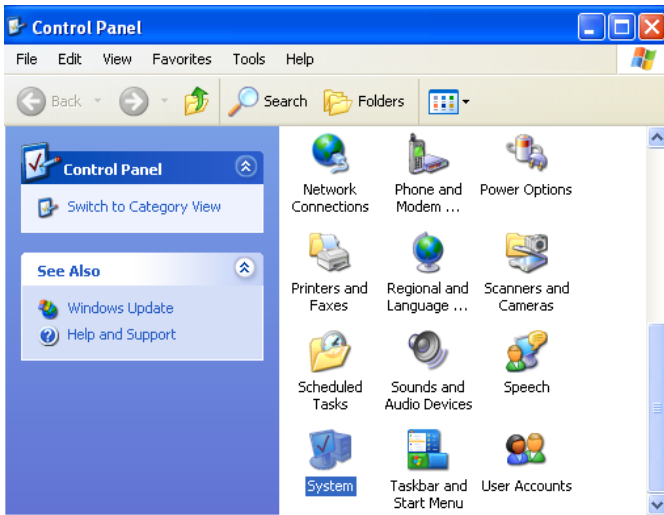

2. Choose “Hardware” and “Device Manager”, press “OK” button.

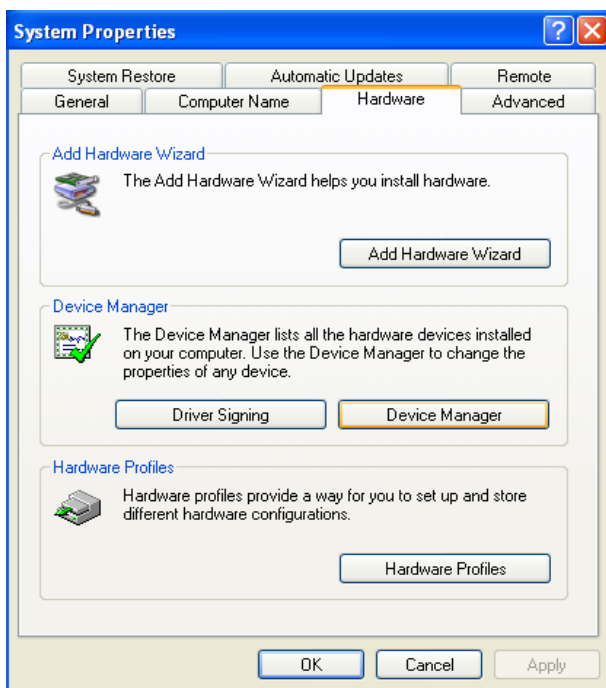

3. Choose “Video Controller (VGA Compatible), press “OK” button.

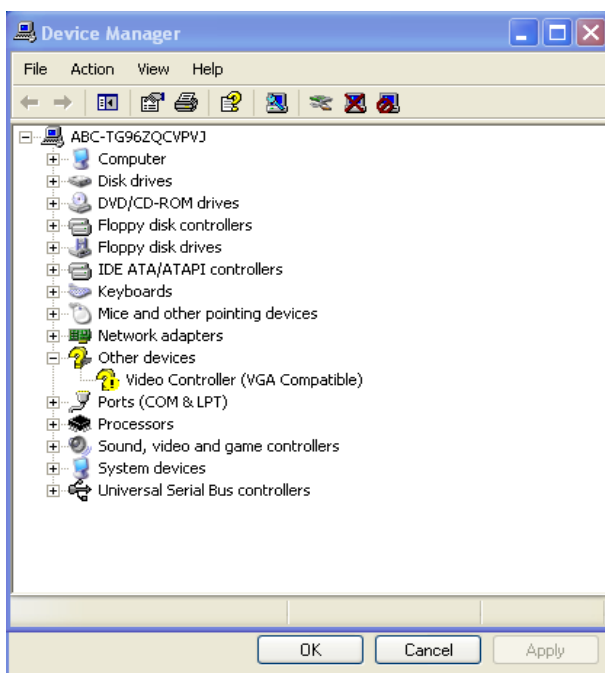

4. Choose "Driver", "Update Driver", press "OK" button.

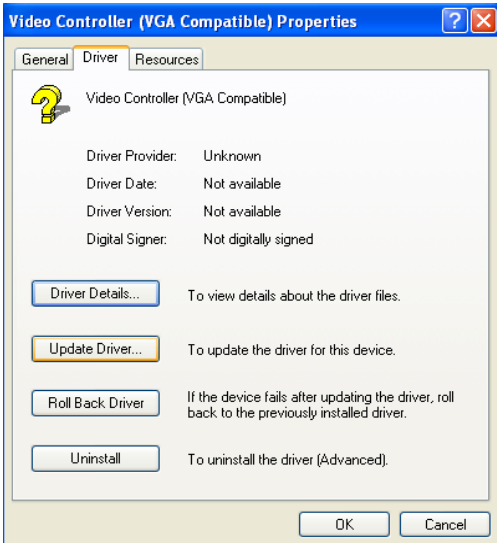

5. Choose "Install from a list.....", press "Next".

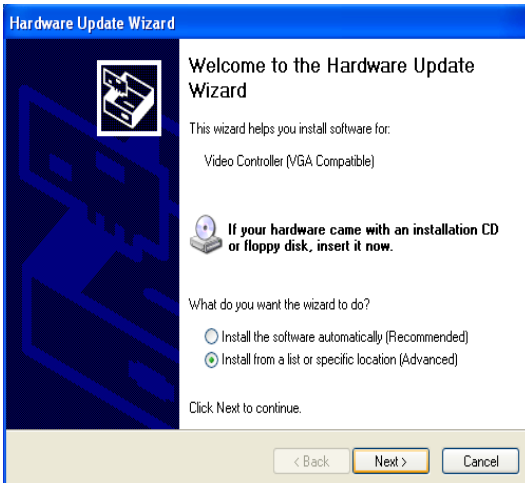

6. Choose “Don’t search. I will....”, press “Next” button.

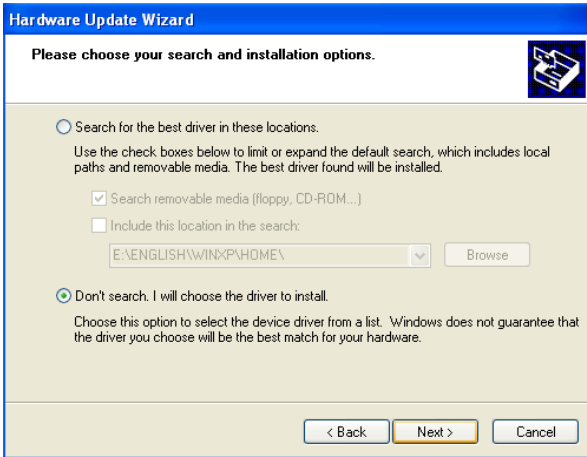

7. Choose “Display adapters”, press “Next” button.

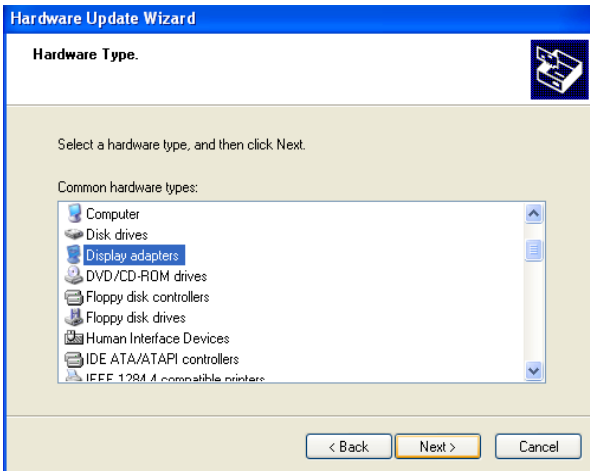

8. Type the path D:\Biscuit\9577\VGA\WinXP then press “OK” button.

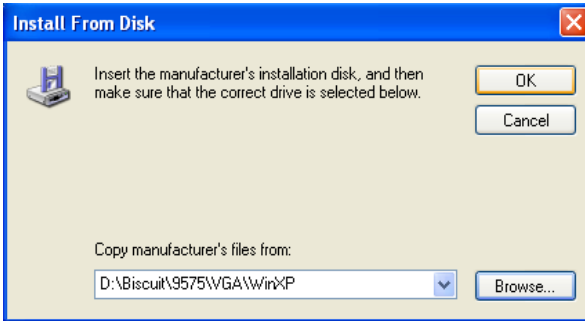

9. Choose “S3 Graphics Twister + S3 Hotkey” then press “Next” button.

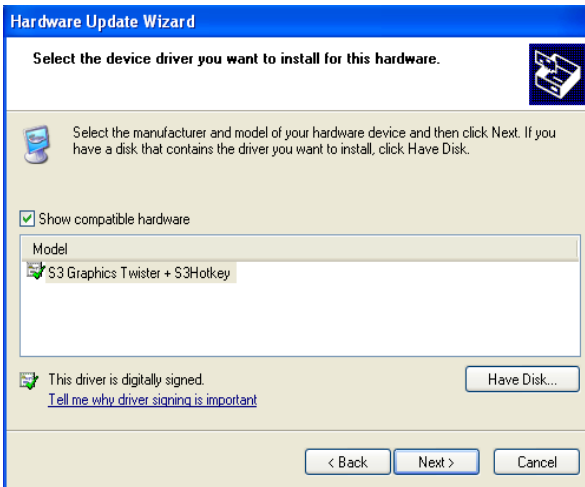

10. Press "Finish" to reboot.

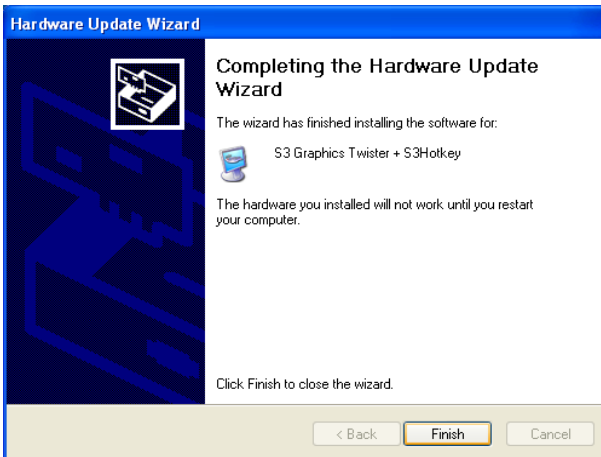

### 4.3 Further Information

---

For further information about the AGP/VGA installation in your PCA-6773, including driver updates, troubleshooting guides and FAQ lists, visit the following web resources:

VIA website: [www.via.com.tw](http://www.via.com.tw)

Advantech websites: [www.advantech.com](http://www.advantech.com)  
[www.advantech.com.tw](http://www.advantech.com.tw)



## **PCI Bus Ethernet Inter- face**

This chapter provides information on Ethernet configuration.

- Introduction
- Installation of Ethernet drivers for Windows 98/2000/NT
- Further information

# Chapter 5 PCI Bus Ethernet Interface

## 5.1 Introduction

---

The board is equipped with a high performance 32-bit Ethernet chipset which is fully compliant with 802.3u 100BASE-T \Fast Ethernet CSMA/CD standards (F version) . It is supported by major network operating systems. It is also both 100Base-T and 10Base-T compatible.

The Ethernet port provides a standard RJ-45 jack. The network boot feature can be utilized by incorporating the boot ROM image files for the appropriate network operating system. The boot ROM BIOS files are combined with system BIOS, which can be enabled/disabled in the BIOS setup.

## 5.2 Installation of Ethernet driver

---

Before installing the Ethernet driver, note the procedures below. You must know which operating system you are using in your board Series, and then refer to the corresponding installation flow chart. Then just follow the steps described in the flow chart. You will quickly and successfully complete the installation, even if you are not familiar with instructions for MS-DOS or Windows.

*Note: The windows illustrations in this chapter are examples only. Follow the steps and pay attention to the instructions which appear on your screen.*

### 5.2.1 Installation for MS-DOS and Windows 3.1

If you want to set up your Ethernet connection under the MS-DOS or Windows 3.1 environment, you should first check your server system model. For example, MS-NT, IBM-LAN server, and so on.

Then choose the correct driver to install in your biscuit PC.

The installation procedures for various servers can be found on the supplied CD-ROM, the correct path being:

D:\Biscuit\9577\LAN\82559er\wfw311

### 5.2.2 Installation for Windows 98/Me

1. a. Select "Start", "Settings". "Control Panel".  
b. Double click "Network".

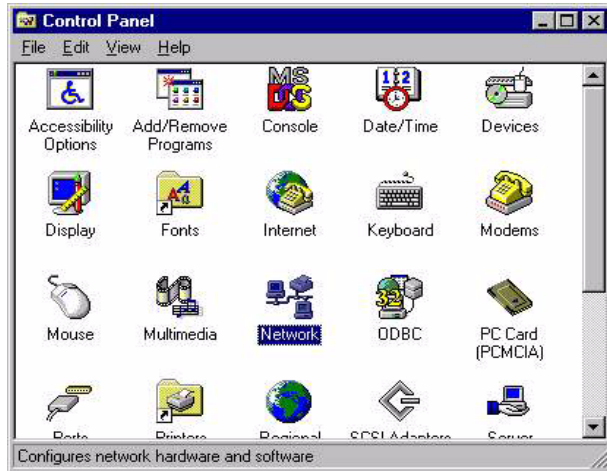

2. a. Click "Add" and prepare to install network functions.

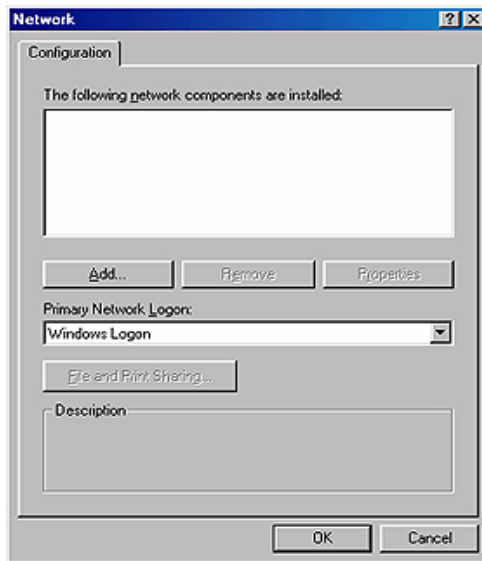

3. a. Select the "Adapter" item to add the Ethernet card.

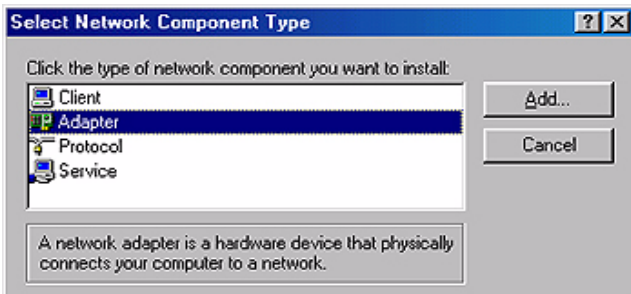

4. a. Click "Have Disk" to install the driver.

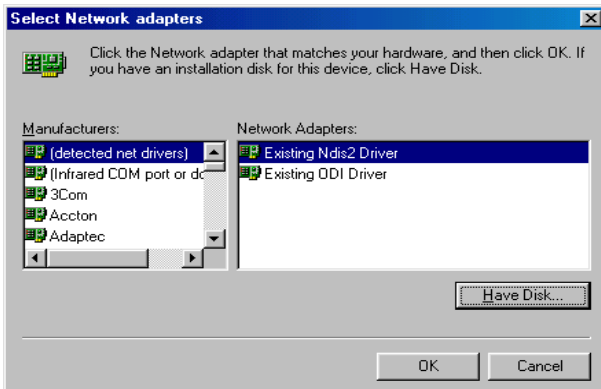

5. a. Insert the CD into the D: drive  
b. Fill in "D:\Biscuit\9577\LAN\  
c. Click "OK"

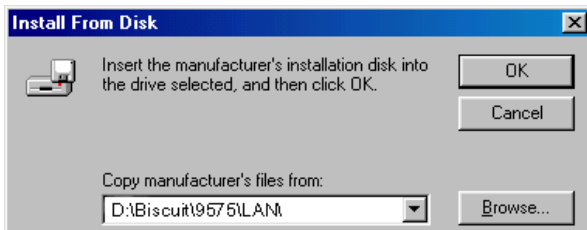

6.
  - a. Choose the "Intel 8255x based PCI Ethernet Adapter (10/100)"
  - b. Click "OK".

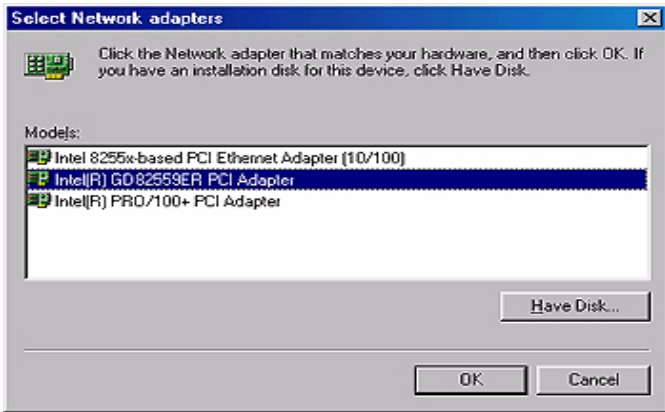

7.
  - a. Make sure the configurations of relative items are set correctly.
  - b. Click "OK" to reboot.

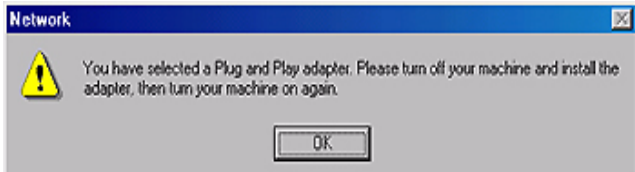

## 5.2.3 Installation for Windows 2000

1. Open Device Manager,

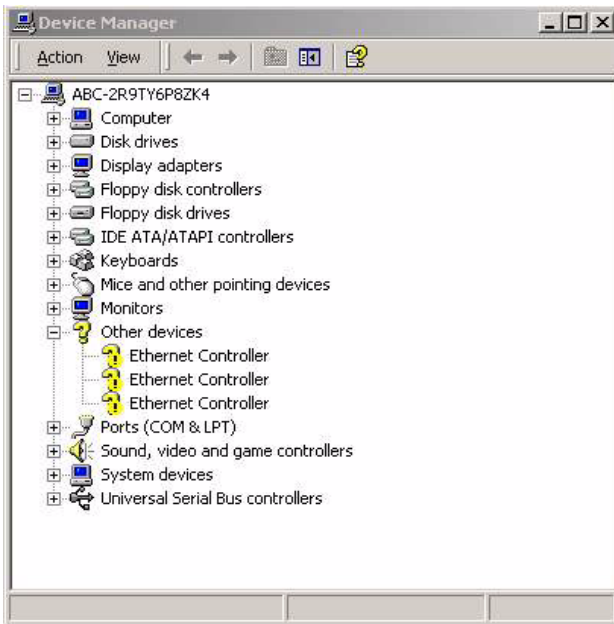

2.

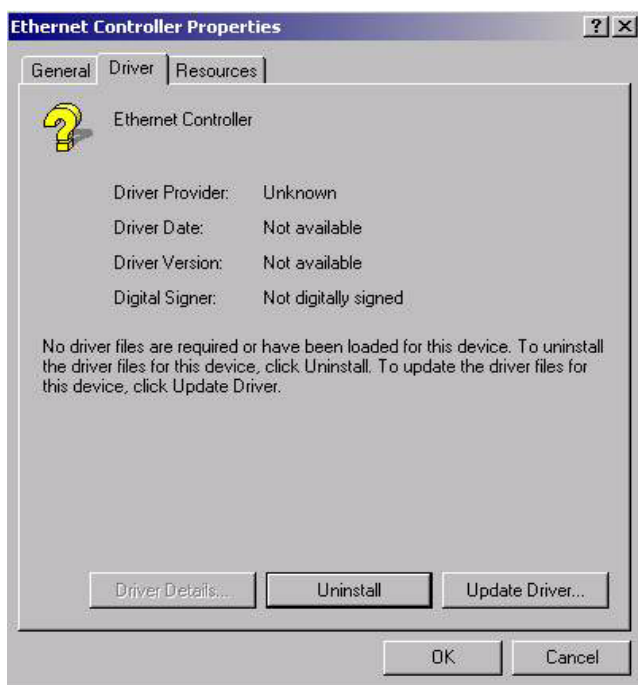

3.



4.





5.

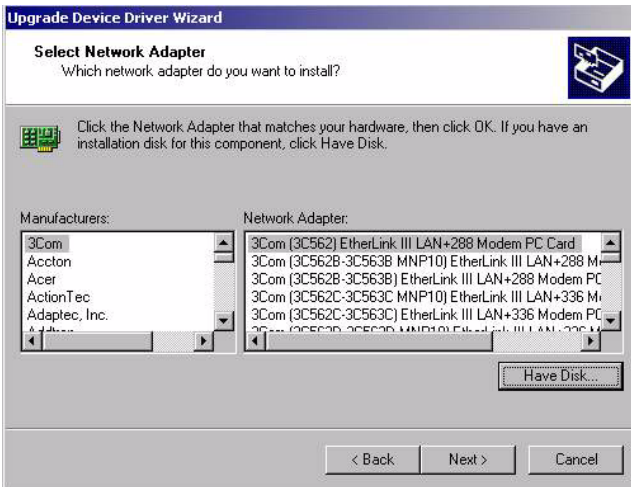

6.



7.

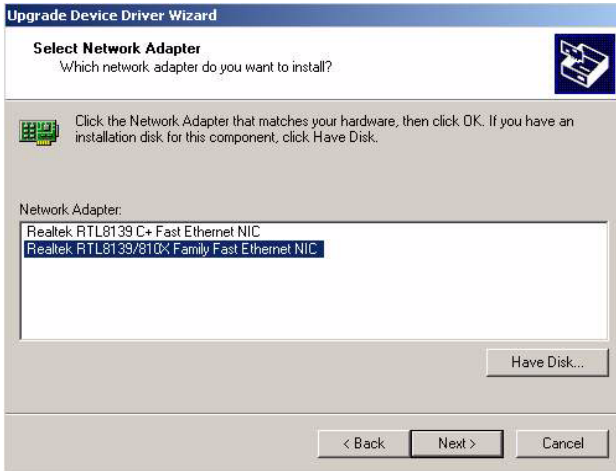

8.



9.



## 5.2.4 Installation for Windows NT

1. a. Select "Start", "Settings", "Control Panel"  
b. Double click "Network"



2. a. Choose type of network.  
b. Click "Next"

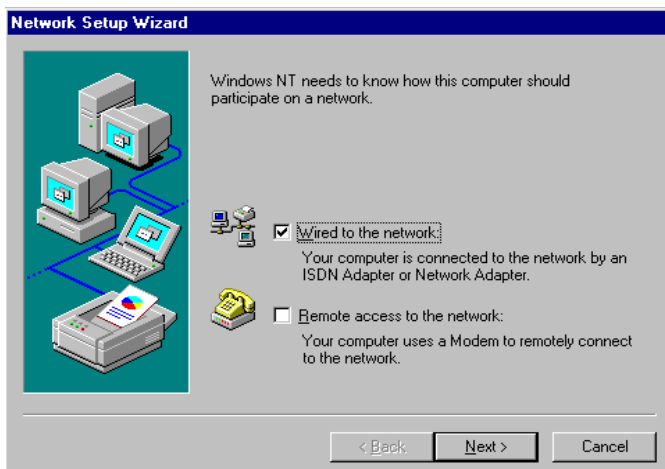

3. a. Click "Select from list..."



4. Click "Have Disk."

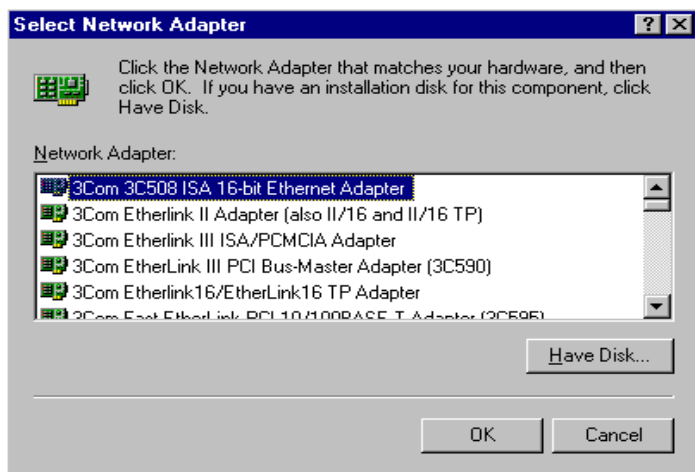

5.
  - a. Insert the Utility CD ROM
  - b. Fill in the correct path: D:\Biscuit\9577\LAN\82559er\winnt4
  - c. Click "OK".

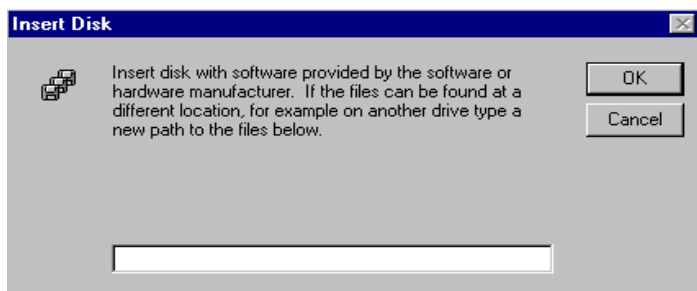

6. Check the highlighted item, and click “OK.”

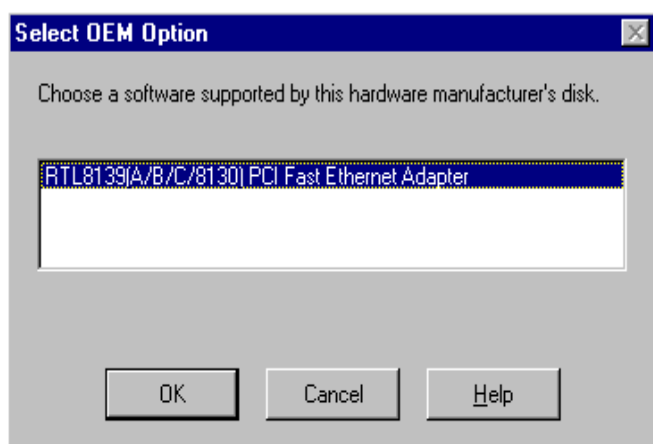

- Click "Next" to continue setup.

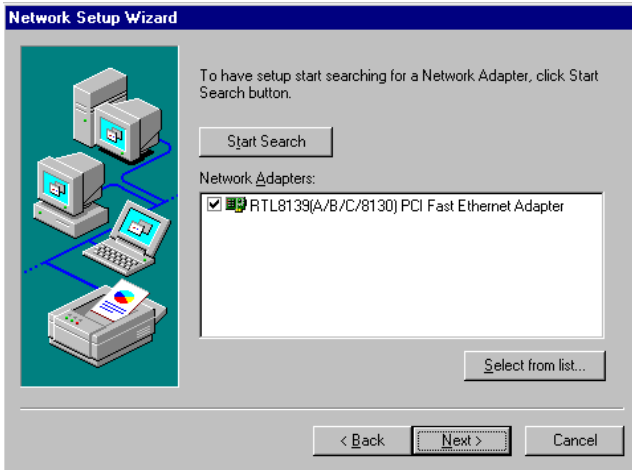

- Choose the networking protocols, then click "Next"

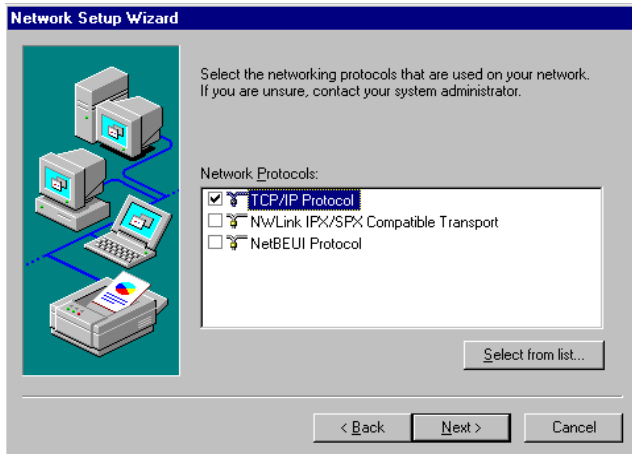

9. Select the correct Network Services then click "Next"

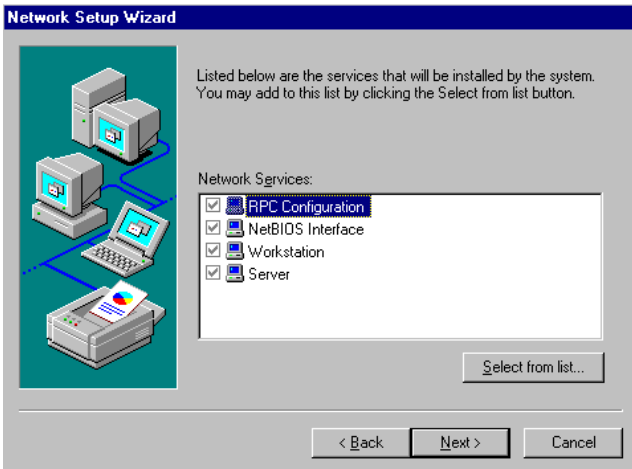

10. Click "Next" to continue setup.

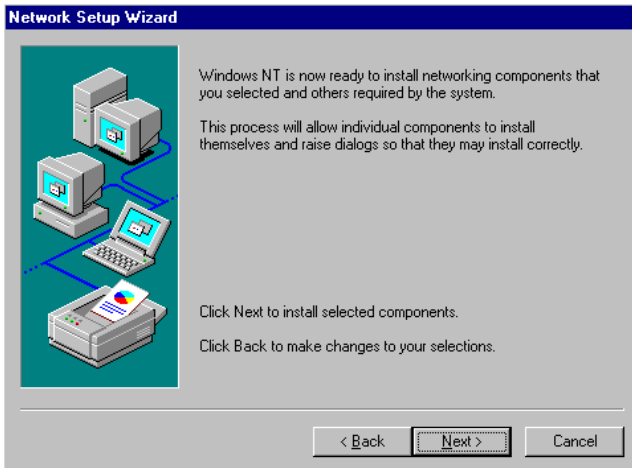



11. Click “Next” to start the network.

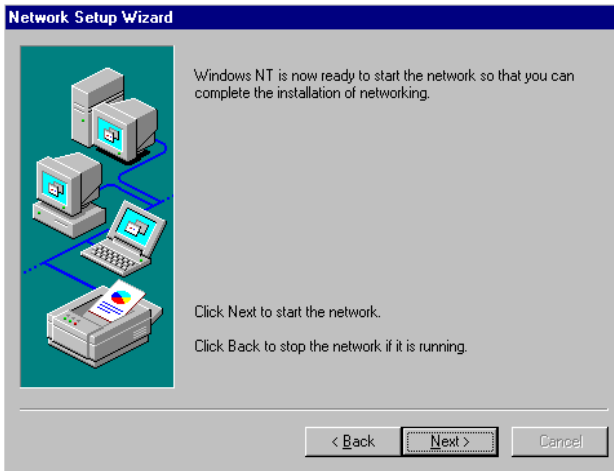

## 5.3 Further information

---

Realtek website:	<a href="http://www.realtek.com.tw">www.realtek.com.tw</a>
Intel website:	<a href="http://www.intel.com">www.intel.com</a>
Advantech websites:	<a href="http://www.advantech.com">www.advantech.com</a> <a href="http://www.advantech.com.tw">www.advantech.com.tw</a>



## **Award BIOS Setup**

This chapter describes how to set BIOS configuration data.

# Chapter 6 Award BIOS Setup

## 6.1 System test and initialization

---

These routines test and initialize board hardware. If the routines encounter an error during the tests, you will either hear a few short beeps or see an error message on the screen. There are two kinds of errors: fatal and non-fatal. The system can usually continue the boot up sequence with non-fatal errors. Non-fatal error messages usually appear on the screen along with the following instructions:

**press <F1> to RESUME**

Write down the message and press the F1 key to continue the bootstrap sequence.

### 6.1.1 System configuration verification

These routines check the current system configuration against the values stored in the board's CMOS memory. If they do not match, the program outputs an error message. You will then need to run the BIOS setup program to set the configuration information in memory.

There are three situations in which you will need to change the CMOS settings:

1. You are starting your system for the first time
2. You have changed the hardware attached to your system
3. The CMOS memory has lost power and the configuration information has been erased.

The PCA-6773 Series' CMOS memory has an integral lithium battery backup. The battery backup should last at least three years in normal service, but when it finally runs down, you will need to replace the complete unit.

## 6.2 Award BIOS setup

---

Award's BIOS ROM has a built-in Setup program that allows users to modify the basic system configuration. This type of information is stored in battery-backed CMOS RAM so that it retains the Setup information when the power is turned off.

### 6.2.1 Entering setup

Power on the computer and press <Del> immediately. This will allow you to enter Setup.

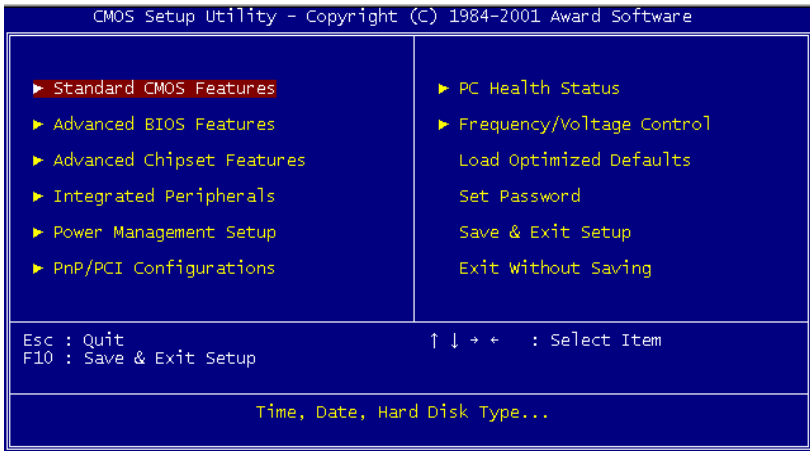

*Figure 6.1: BIOS setup program initial screen*

## 6.2.2 Standard CMOS Features setup

When you choose the Standard CMOS Features option from the Initial Setup Screen menu, the screen shown below is displayed. This standard Setup Menu allows users to configure system components such as date, time, hard disk drive, floppy drive and display. Once a field is highlighted, on-line help information is displayed in the left bottom of the Menu screen.

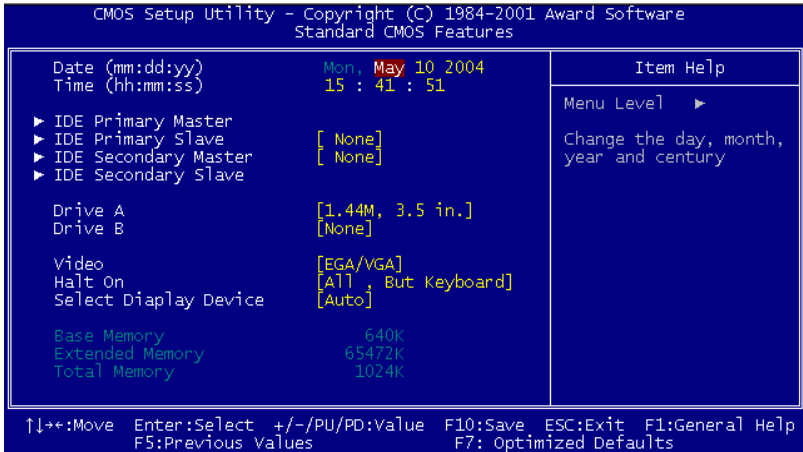

*Figure 6.2: CMOS Features setup*

## 6.2.3 Advanced BIOS Features setup

By choosing the Advanced BIOS Features Setup option from the Initial Setup Screen menu, the screen below is displayed. This sample screen contains the manufacturer's default values for the PCA-6773 Series.

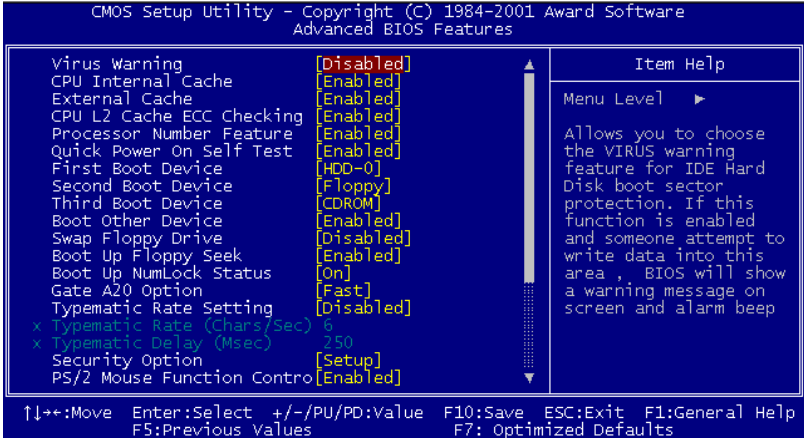

*Figure 6.3: Advanced BIOS Features setup*

## 6.2.4 Advanced Chipset Features setup

By choosing the Advanced Chipset Features option from the Initial Setup Screen menu, the screen below is displayed. This sample screen contains the manufacturer's default values for the PCA-6773 Series.

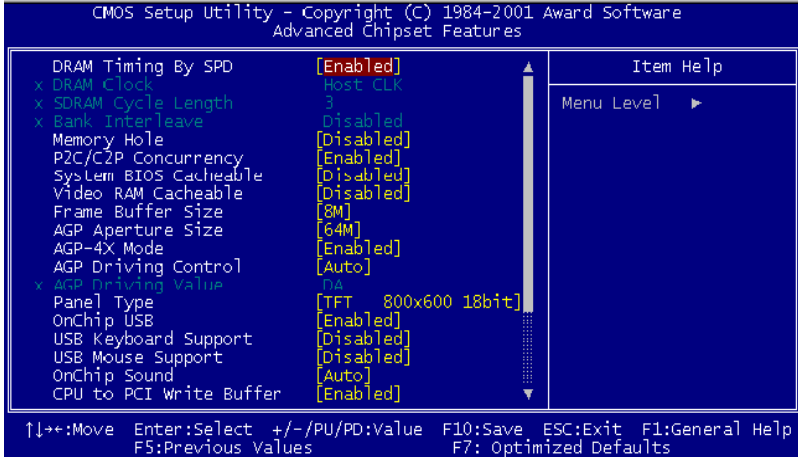

*Figure 6.4: Advanced Chipset Features setup*



## 6.2.5 Integrated Peripherals

Choosing the Integrated Peripherals option from the Initial Setup Screen menu should produce the screen below. Here we see the manufacturer's default values for the PCA-6773 Series.

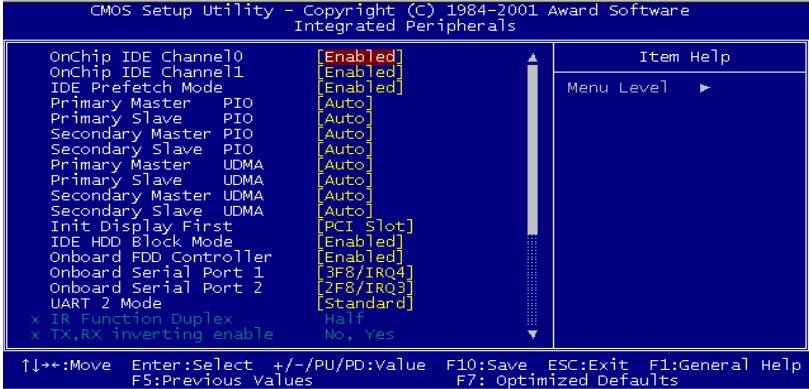

Figure 6.5: Integrated Peripherals

## 6.2.6 Power Management Setup

By choosing the Power Management Setup option from the Initial Setup Screen menu, the screen below is displayed. This sample screen contains the manufacturer's default values for the PCA-6773 Series.

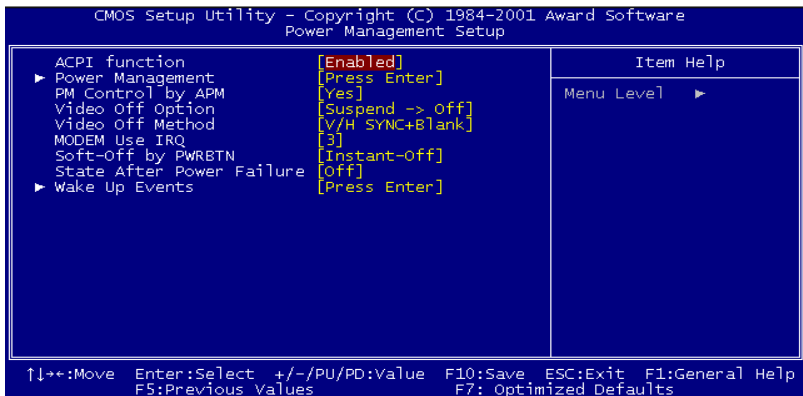
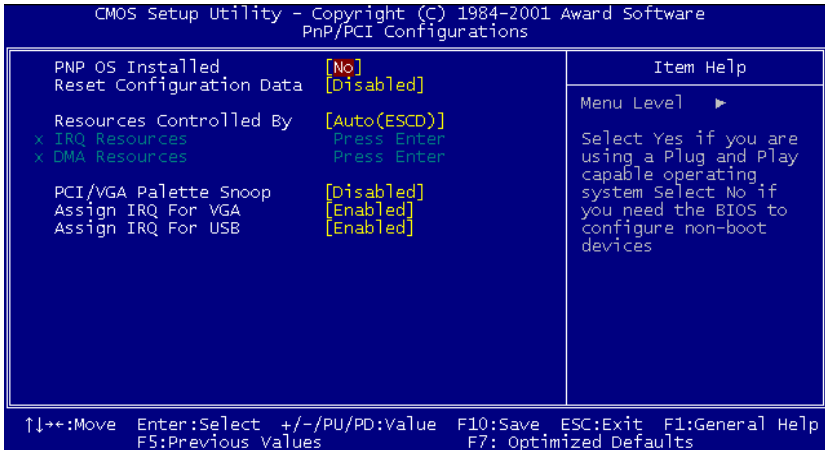

Figure 6.6: Power Management Setup

## 6.2.7 PnP/PCI Configurations

By choosing the PnP/PCI Configurations option from the Initial Setup Screen menu, the screen below is displayed. This sample screen contains the manufacturer's default values for the PCA-6773 Series.



*Figure 6.7: PnP/PCI Configurations*

## 6.2.8 PC Health Status

The PC Health Status option displays information such as CPU and motherboard temperatures, fan speeds, and core voltage.

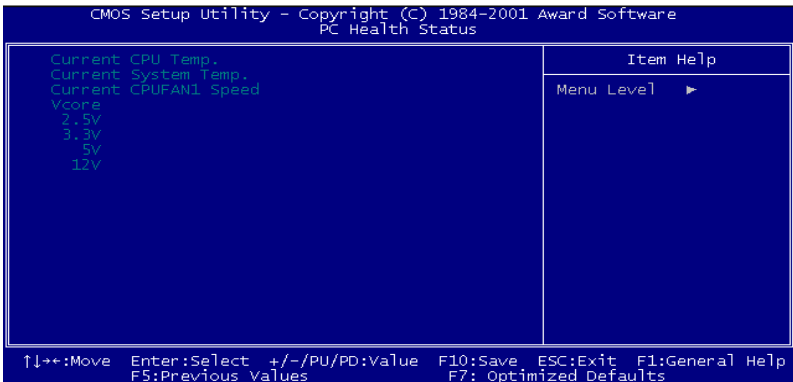

*Figure 6.8: PC Health Status*

## 6.2.9 Frequency/Voltage Control

By choosing the Frequency/Voltage Control option from the Initial Setup Screen menu, the screen below is displayed. This sample screen contains the manufacturer's default values for the PCA-6773

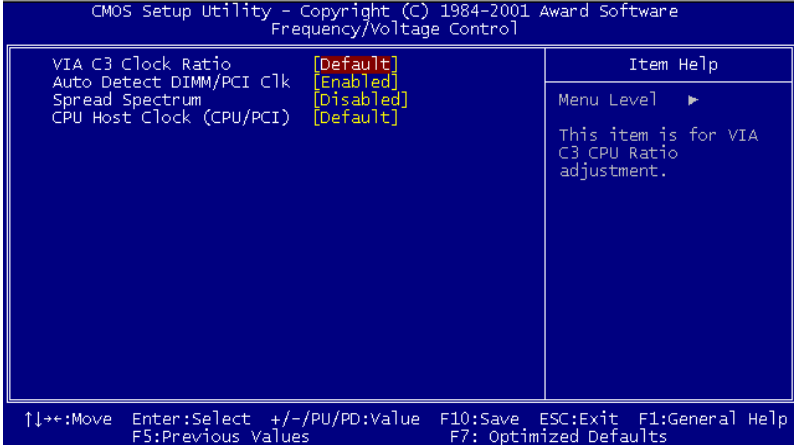
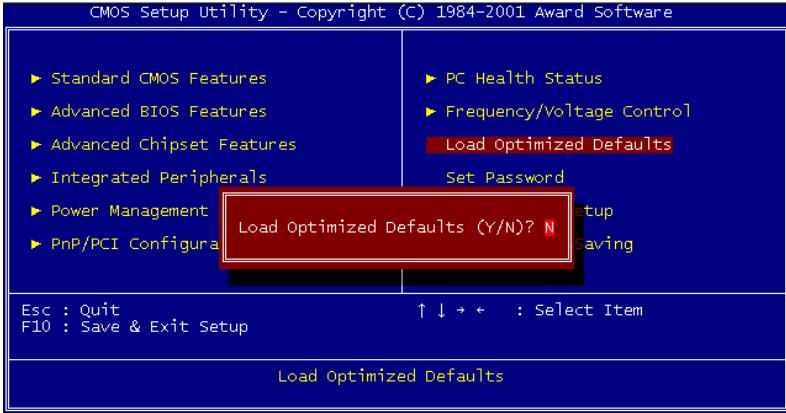

**Figure 6.9: Frequency/Voltage Control**

**Caution** *Incorrect settings in Frequency/Voltage Control may damage the system CPU, video adapter, or other hardware.*

## 6.2.10 Load Optimized Defaults

Load Optimized Defaults loads the default system values directly from ROM. If the stored record created by the Setup program should ever become corrupted (and therefore unusable), these defaults will load automatically when you turn the PCA-6773 Series system on.



*Figure 6.10: Load BIOS defaults screen*

## 6.2.11 Set Password

**Note** *To enable this feature, you should first go to the Advanced BIOS Features menu, choose the Security Option, and select either Setup or System, depending on which aspect you want password protected. Setup requires a password only to enter Setup. System requires the password either to enter Setup or to boot the system.*

*A password may be at most 8 characters long.*

### To Establish Password

1. Choose the Set Password option from the CMOS Setup Utility main menu and press <Enter>.
2. When you see “Enter Password,” enter the desired password and press <Enter>.

3. At the “Confirm Password” prompt, retype the desired password, then press <Enter>.
4. Select Save to CMOS and EXIT, type <Y>, then <Enter>.

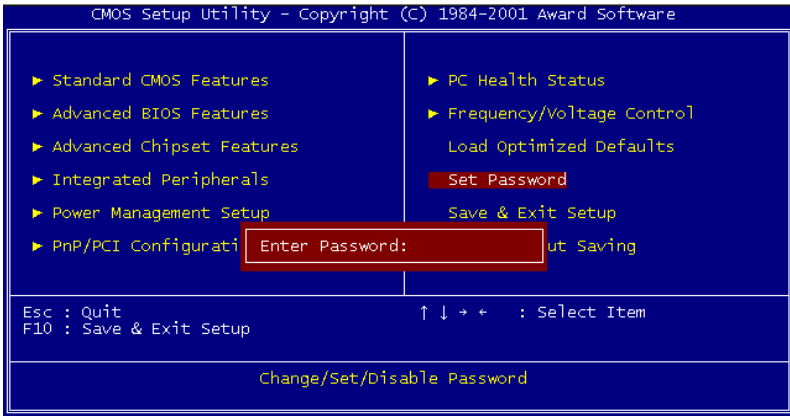

*Figure 6.11: Set password*

### To Change Password

1. Choose the Set Password option from the CMOS Setup Utility main menu and press <Enter>.
2. When you see “Enter Password,” enter the existing password and press <Enter>.
3. You will see “Confirm Password.” Type it again, and press <Enter>.
4. Select Set Password again, and at the “Enter Password” prompt, enter the new password and press <Enter>.
5. At the “Confirm Password” prompt, retype the new password, and press <Enter>.
6. Select Save to CMOS and EXIT, type <Y>, then <Enter>.

### To Disable Password

1. Choose the Set Password option from the CMOS Setup Utility main menu and press <Enter>.
2. When you see “Enter Password,” enter the existing password and press <Enter>.

3. You will see “Confirm Password.” Type it again, and press <Enter>.
4. Select Set Password again, and at the “Enter Password” prompt, don’t enter anything; just press <Enter>.
5. At the “Confirm Password” prompt, again don’t type in anything; just press <Enter>.
6. Select Save to CMOS and EXIT, type <Y>, then <Enter>.

## 6.2.12 Save & Exit Setup

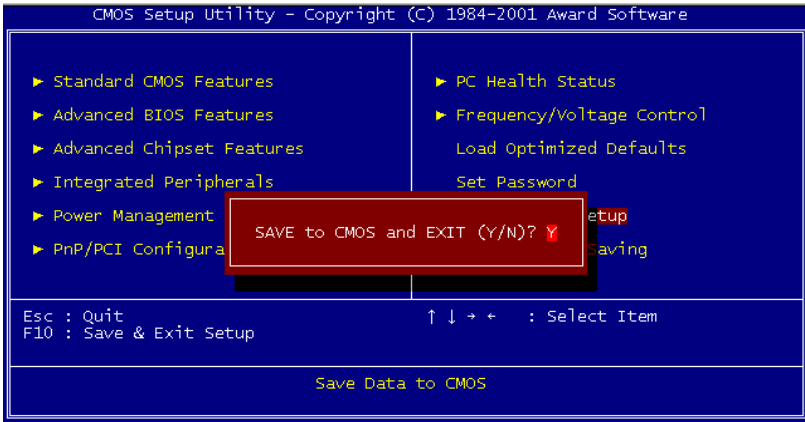

**Figure 6.12: Save to CMOS and EXIT**

If you select this option and press <Y> then <Enter>, the values entered in the setup utilities will be recorded in the chipset’s CMOS memory. The microprocessor will check this every time you turn your system on and use the settings to configure the system. This record is required for the system to operate.

## 6.2.13 Exit Without Saving

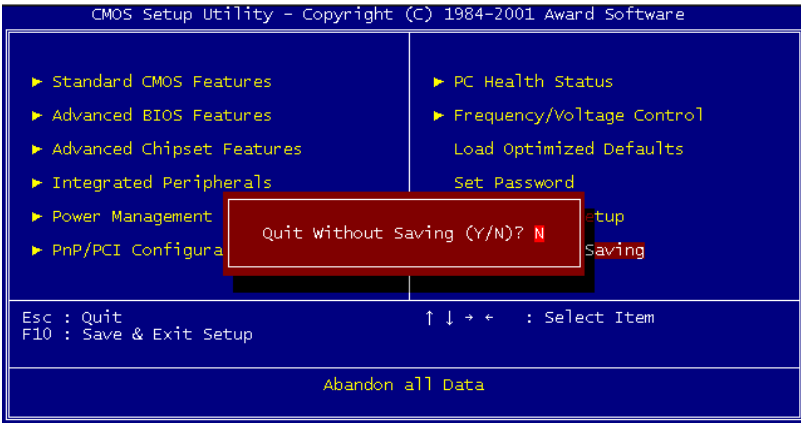

*Figure 6.13: Quit without saving*

Selecting this option and pressing <Enter> lets you exit the Setup program without recording any new values or changing old ones.





## **Programming the Watchdog Timer**

The board is equipped with a watchdog timer that resets the CPU or generates an interrupt if processing comes to a standstill for any reason. This feature ensures system reliability in industrial standalone or unmanned environments.

# Appendix A Programming the Watchdog Timer

## A.1 Supported Input Timing Modes

---

In order to program the watchdog timer, you must write a program which writes I/O port address 443 (hex). The output data is a value of time interval. The value range is from 01 (hex) to 3E (hex), and the related time interval is 1 sec. to 62 sec.

<b>Data</b>	<b>Time Interval</b>
01	1 sec.
02	2 sec.
03	3 sec.
04	4 sec.
	.
	.
	.
3E	62 sec.

After data entry, your program must refresh the watchdog timer by rewriting the I/O port 443 (hex) while simultaneously setting it. When you want to disable the watchdog timer, your program should read I/O port 443 (hex).

The following example shows how you might program the watchdog timer in BASIC:

```
10      REM Watchdog timer example program
20      OUT &H443, data  REM Start and restart the
      watchdog
30      GOSUB 1000  REM Your application task #1
40      OUT &H443, data  REM Reset the timer
50      GOSUB 2000  REM Your application task #2
60      OUT &H443, data  REM Reset the timer
70      X=INP (&H443)  REM Disable the watchdog timer
80      END

1000    REM  Subroutine #1, your application task
      .
      .
      .
1070    RETURN
2000    REM  Subroutine #2, your application task
      .
      .
      .
2090    RETURN
```



## **Installing PC/104 Modules**

This appendix gives instructions for installing PC/104 modules.

# Appendix B Installing PC/104 Modules

## B.1 Installing PC/104 Modules

---

This SBC's PC/104 connectors give you the flexibility to attach PC/104 modules.

Installing these modules on the board is quick and simple. The following steps show to mount the PC/104 modules:

1. Remove the board from your system, paying particular attention to the safety instructions already mentioned above.
2. Make any jumper or link changes required to the CPU card now. Once the PC/104 module is mounted, you may have difficulty in accessing these.
3. Normal PC/104 modules have male connectors and mount directly onto the main card. (Refer to the diagram on the following page.)
4. Mount the PC/104 module onto the CPU card by pressing the module firmly but carefully onto the mounting connectors.
5. Secure the PC/104 module onto the CPU card using the four mounting spacers and screws.

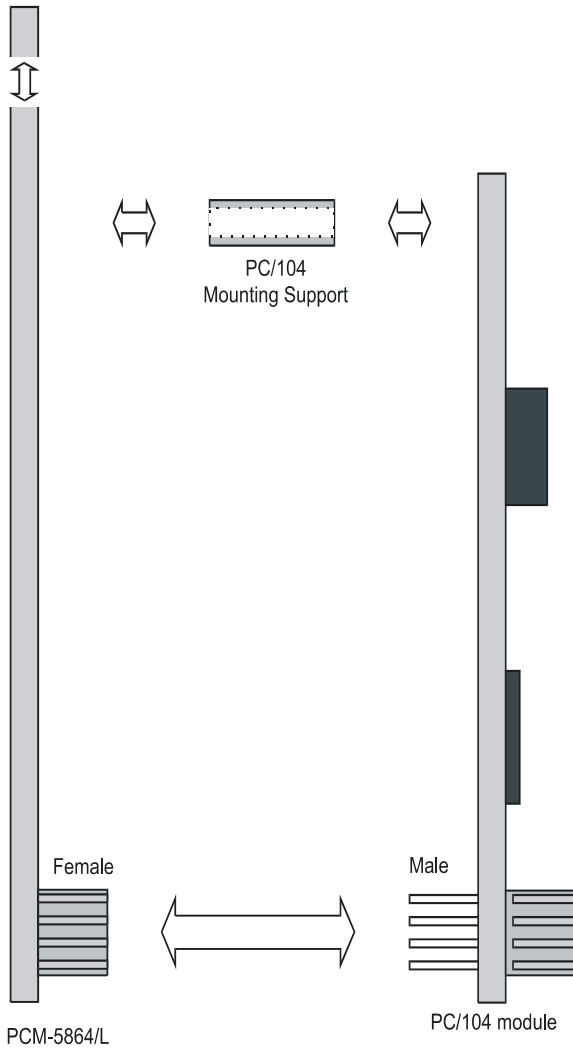

**Figure B.1: PC/104 module mounting diagram**

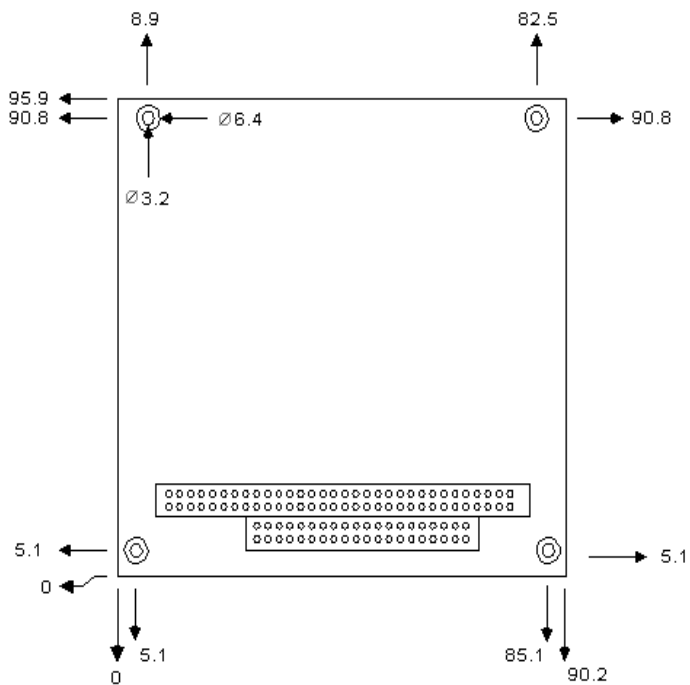

**Figure B.2: PC/104 module dimensions (mm) ( $\pm 0.1$ )**



## Pin Assignments

This appendix contains information of a detailed or specialized nature. It includes:

- PWR\_SW Connector
- Parallel Port Connector
- Floppy Drive Connector
- Primary IDE Connector
- CRT Display Connector
- USB Connector
- LAN, RJ45 connector
- Main Power Connector
- Power , HDD LED& WDT output
- Flat Panel Connector
- Extension Flat Panel Connector
- LVDS LCD Connector
- LCD Inverter Connector
- Panel back-light connector
- External KB/Mouse Connector
- Reset Button Connector
- Keyboard and PS/2 Mouse Connector
- CPU Fan Power Connector
- COM Port Connector
- ATX soft power switch Connector
- DIO Connector
- CompactFlash card Connector
- Audio Connector
- IR Connector

# Appendix C Pin Assignments

## C.1 ATX suspend power connector (CN24)

---



---

**Table C.1: ATX suspend power connector(CN24)**

---

Pin	Signal
1	Suspend 5V
2	GND
3	PS_ON signal

---

## C.2 Floppy connector (CN4)

Table C.2: Floppy Connector (CN4)

Pin	Signal	Pin	Signal
1	GND	2	RWC#
3	GND	4	NC
5	GND	6	NC
7	GND	8	Index#
9	GND	10	MOA#
11	GND	12	DSB#
13	GND	14	DSA#
14	GND	16	MOB#
17	GND	18	DIR#
19	GND	20	STEP#
21	GND	22	WD#
23	GND	24	WE#
25	GND	26	Track0#
27	GND	28	WP#
29	GND	30	RDATA#
31	GND	32	HEAD#
33	GND	34	DSKCHG#

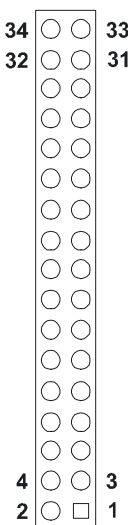

\*low active

## C.3 Primary IDE Connector (CN3)

**Table C.3: Primary IDE connector (CN3)**

Pin	Signal	Pin	Signal
1	IDE RESET	2	GND
3	D7	4	D8
5	D6	6	D9
7	D5	8	D10
9	D4	10	D11
11	D3	12	D12
13	D2	14	D13
15	D1	16	D14
17	D0	18	D15
19	GND	20	NC
21	REQ	22	GND
23	IOW	24	GND
25	IOR	26	GND
27	READY	28	Cable Select
29	DACK	30	GND
31	IRQ14	32	NC
33	A1	34	ATA check
35	A0	36	A2
37	CS1#	38	CS3#
39	Active	40	GND

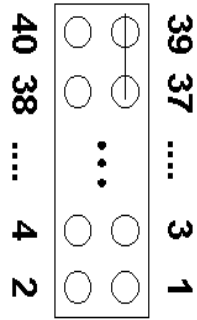

## C.4 CompactFlash connector(CN28)

Pin	Signal	Pin	Signal
1	GND	26	#CD1
2	D3	27	D11
3	D4	28	D12
4	D5	29	D13
5	D6	30	D14
6	D7	31	D15
7	#CE	32	#CE2
8	A10	33	#VS14
9	#OE	34	#IORD
10	A9	35	#IOWR
11	A8	36	#WE
12	A7	37	#IRQ
13	VCC	38	VCC
14	A6	39	#CSEL
15	A5	40	#VS2
16	A4	41	RESET
17	A3	42	#WAIT
18	A2	43	#INPACK
19	A1	44	#REG
20	A0	45	BVD2
21	D0	46	BVD1
22	D1	47	D8
23	D2	48	D9
24	IOCS16	49	D10
25	#CD2	50	GND

## C.5 LAN,RJ45 connector(CN18)

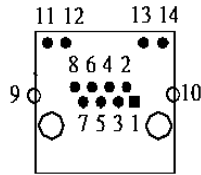

**Table C.5: LAN,RJ45 connector(CN18)**

Pin	Signal	Pin	Signal
1	TX+	8	GND
2	TX-	9	GND
3	RX+	10	GND
4	GND	11	VCC_LAN(TX/RX)
5	GND	12	ACTLED
6	RX-	13	VCC_LAN
7	GND	14	LILEN(LINK10/100M)

## C.6 USB1, 2 connector(CN25)

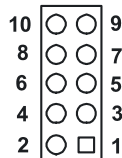
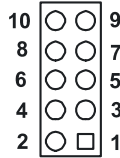

**Table C.6: USB 1, 2 connector(CN25)**

Pin	Signal	Pin	Signal
1	+5V	2	+5V
3	USB0-	4	USB1-
5	USB0+	6	USB1+
7	USB GND	8	USB GND
9	GND	10	NC

## C.7 USB 3, 4 connector(CN9)

---

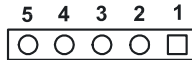

**Table C.7: USB 3, 4 connector(CN9)**

Pin	Signal	Pin	Signal
1	+5V	2	+5V
3	USB0-	4	USB1-
5	USB0+	6	USB1+
7	USB GND	8	USB GND
9	GND	10	NC

## C.8 IR connector(CN13)

---

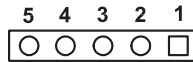

**Table C.8: IR connector(CN13)**

Pin	Signal
1	+5V
2	NC
3	RX
4	GND
5	TX

## C.9 LCD INV power connector(CN8)

---



---

**Table C.9: LCD INV power connector (CN8)**

---

Pin	Signal
1	+12V output
2	GND
3	Back-light enable signal output
4	Back-light VBR signal output
5	+5V output

## C.10 LCD Backlight connector(CN7)

---



---

**Table C.10: LCD Backlight connector (CN7)**

---

Pin	Signal
1	connect to VR pin-1
2	connect to VR pin-2
3	connect to VR pin-3



## C.11 DIO connector(CN15)

---

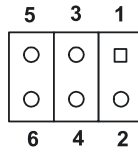

---

**Table C.11: DIO connector(CN15)**

---

Pin	Signal	Pin	Signal
1	IO0	2	IO1
3	IO2	4	IO3
5	GND	6	GND

---

## C.12 HDD, PWR LED connector & WDT output( CN6)

---

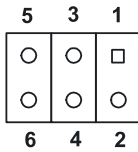

---

**Table C.12: HDD, PWR LED connector &WDT output(CN6)**

---

Pin	Signal	Pin	Signal
1	WDT Output	2	GND
3	GND	4	PWR LED
5	VCC	6	HDD LED

---

## C.13 LVDS connector(CN10)

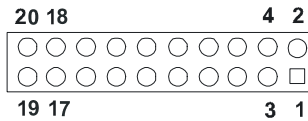

**Table C.13: LVDS connector(CN10)**

Pin	Signal
1	GND
2	GND
3	Y0P signal output
4	Z0P signal output
5	Y0M signal output
6	Z0M signal output
7	Y1P signal output
8	Z1P signal output
9	Y1M signal output
10	Z1M signal output
11	Y2P signal output
12	Z2P signal output
13	Y2M signal output
14	Z2M signal output
15	YCP signal output
16	ZCP signal output
17	YCM signal output
18	ZCM signal output
19	+3.3V output
20	+3.3V output

## C.14 LPT connector(CN5)

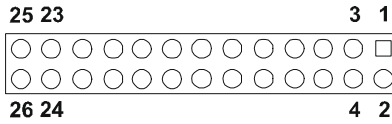

<b>Pin</b>	<b>Signal</b>	<b>Pin</b>	<b>Signal</b>
1	STB#	2	AFD#
3	D0	4	ERR
5	D1	6	INIT#
7	D2	8	SLIN
9	D3	10	GND
11	D4	12	GND
13	D5	14	GND
15	D6	16	GND
17	D7	18	GND
19	ACK#	20	GND
21	BUSY	22	GND
23	PE	24	GND
25	SLCT	26	NC

## C.15 Extension Panel Connector (CN11)

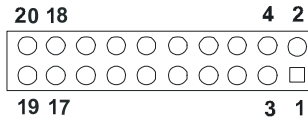

**Table C.15: Extension Panel Connector (CN11)**

Pin	Signal	Pin	Signal
1	GND	2	GND
3	PD24 signal output	4	PD25 signal output
5	PD26 signal output	6	PD27 signal output
7	PD28 signal output	8	PD29 signal output
9	PD30 signal output	10	PD31 signal output
11	PD32 signal output	12	PD33 signal output
13	PD34 signal output	14	PD35 signal output
15	GND	16	GND
17	NC	18	NC
19	NC	20	NC

## C.16 COM 1, 2 Connector (CN21, CN20)

**Table C.16: COM connector (CN 21, CN20)**

COM1 connector (CN21)				COM2 connector (CN20)			
Pin	Signal	Pin	Signal	Pin	Signal	Pin	Signal
1	DCD	6	DSR	1	DCD	2	DSR
2	RX	7	RTS	3	SIN	4	RTS
3	TX	8	CTS	5	SOUT	6	CTS
4	DTR	9	RI	7	DTR-	8	RI
5	GND			9	GND	10	N.C.
				11	TXD485+	12	TXD485-
				13	RXD485+	14	RXD485-

## C.17 Audio I/F connector(CN12)

---

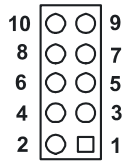

**Table C.17: Audio I/F connector(CN12)**

Pin	Signal	Pin	Signal
1	+5V	2	BitCLK
3	DATA IN	4	GND
5	GND	6	Sync
7	DATA OUT	8	ACRST
9	+5V	10	PCBEEP

## C.18 D-SUB VGA connector(CN16)

---

**Table C.18: D-SUB VGA connector(CN16)**

Pin	Signal	Pin	Signal
1	R	9	+5V
2	G	10	GND
3	B	11	NC
4	NC	12	S-DATA
5	GND	13	HSYNC
6	GND	14	VSYSN
7	GND	15	S-CLK
8	GND		

## C.19 Negative power input connector(CN22)

---



---

**Table C.19: Negative power input connector(CN22)**

---

Pin	Signal
1	-5V
2	GND
3	-12V

---

## C.20 Keyboard and Mouse connector(CN26)

---

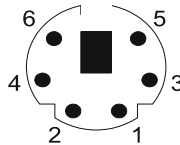

---

**Table C.20: Keyboard and mouse connector(CN26)**

---

Pin	Signal
1	KBDATA
2	MSDATA
3	GND
4	+5V
5	KBCLK
6	MSCLK

---

## C.21 EXT\_KB/Mouse connector(CN23)

---

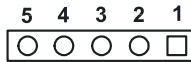
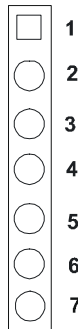

**Table C.21: EXT\_KB/Mouse connector(CN23)**

Pin	Signal
1	KBCLK
2	KBDATA
3	NC
4	GND
5	+5V

## C.22 Main power connector (CN19)

---



**Table C.22: Main power connector(CN19)**

Pin	Signal	Pin	Signal
1	+5V	2	GND
3	GND	4	+12V
5	NC	6	GND
7	+5V		

## C.23 LCD connector(CN14)

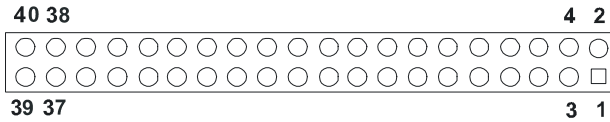

**Table C.23: LCD connector(CN14)**

Pin	Signal	Pin	Signal
1	+5V output	2	+5V output
3	GND	4	GND
5	+3.3V output	6	+3.3V output
7	GND	8	NC
9	PD0 signal output	10	PD1 signal output
11	PD2 signal output	12	PD3 signal output
13	PD4 signal output	14	PD5 signal output
15	PD6 signal output	16	PD7 signal output
17	PD8 signal output	18	PD9 signal output
19	PD10 signal output	20	PD11 signal output
21	PD12 signal output	22	PD13 signal output
23	PD14 signal output	24	PD15 signal output
25	PD16 signal output	26	PD17 signal output
27	PD18 signal output	28	PD19 signal output
29	PD20 signal output	30	PD21 signal output
31	PD22 signal output	32	PD23 signal output
33	GND	34	GND
35	Fpclk signal output	36	FPVS signal output
37	FPDE signal output	38	FPHS signal output
39	NC	40	ENVEE signal output



## C.24 PWR\_SW connector(CN1)

---

Table C.24: PWR\_SW connector(CN1)

Pin	Signal	Pin	Signal
1	Power ON/OFF signal	2	GND

## C.25 Reset connector(CN2)

---

Table C.25: Reset connector(CN2)

Pin	Signal	Pin	Signal
1	Reset signal	2	GND

## C.26 CPU Fan connector (FAN1)

---



Table C.26: CPU Fan connector(FAN1)

Pin	Signal
1	Speed Monitor
2	+5V
3	GND



## **System Assignments**

This appendix contains information of a detailed nature. It includes:

- System I/O ports
- 1st MB memory map
- DMA channel assignments
- Interrupt assignments

# Appendix D System Assignments

## D.1 System I/O Ports

<b>Addr. range (Hex)</b>	<b>Device</b>
00-1F	Master DMA controller
20-3F	Master Interrupt controller
40-5F	Timer/Counter
60-6F	Keyboard controller
(60h)	KBC Data
(61h)	Misc Funtions & Spkr Ctrl
(64h)	KBC Command/Status
70-77	RTC/COMS/NMI-Disable
78-7F	-available for system use-
80	-reserved-(debug port)
81-8F	DMA Page Registers
90-91	-available for system use-
92	System Control
93-9F	-available for system use-
A0-BF	Slave Interrupt Controller
C0-DF	Slave DMA Controller
E0-FF	-available for system use-
100-CF7	-available for system use-
CF8-CFB	PCI Configuration Address
CFC-CFF	PCI Configuration Data
D00-FFFF	-available for system use-
200-20F	Game Port
2F8-2FF	COM2
378-37F	Parallel Port(Standard & AFF)
3F0-3F1	Configuration Index/Data
3F0-3F7	Floppy Controller
3F8-3FF	COM1
778-77A	Parallel Port(ECP Extensions)(Port 378+400)

MPU-401 select from 300 ~ 330H (2 bytes)

## D.2 1st MB memory map

---

**Table D.2: 1st MB memory map**

Addr. range (Hex)	Device
F0000h - FFFFFh	System ROM
*CC000h - EFFFFh	Unused (reserved for Ethernet ROM)
C0000h - CBFFFh	Expansion ROM (for VGA BIOS)
B8000h - BFFFFh	CGA/EGA/VGA text
B0000h - B7FFFh	Unused
A0000h - AFFFFh	EGA/VGA graphics
00000h - 9FFFFh	Base memory

\* If Ethernet boot ROM is disabled (Ethernet ROM occupies about 16 KB)

\* E0000 - EFFFF is reserved for BIOS POST

## D.3 DMA channel assignments

---

**Table D.3: DMA channel assignments**

Channel	Function
0	Available
1	Available (audio)
2	Floppy disk (8-bit transfer)
3	Available (parallel port)
4	Cascade for DMA controller 1
5	Available
6	Available
7	Available

\* Audio DMA select 1, 3, or 5

\*\* Parallel port DMA select 1 (LPT2) or 3 (LPT1)

## D.4 Interrupt assignments

---

<b>Interrupt#</b>	<b>Interrupt source</b>
IRQ 0	Interval timer
IRQ 1	Keyboard
IRQ 2	Interrupt from controller 2 (cascade)
IRQ 3	COM2
IRQ 4	COM1
IRQ 5	Unused
IRQ 6	FDD
IRQ 7	LPT1
IRQ 8	RTC
IRQ 9	Reserved (audio)
IRQ 10	Unused
IRQ 11	Reserved for watchdog timer
IRQ 12	PS/2 mouse
IRQ 13	INT from co-processor
IRQ 14	Primary IDE
IRQ 15	Secondary IDE for CFC

\* Ethernet interface IRQ select: 9, 11, 15

\* PNP audio IRQ select: 9, 11, 15

\* PNP USB IRQ select: 9, 11, 15

\* PNP ACPI IRQ select: 9, 11, 15