

User Manual

MIC-3392

6U CompactPCI Intel Core 2 Duo
Processor Based Board with
Dual PCIe GbE/DDR2/SATA/PMC

Trusted ePlatform Services

ADVANTECH

Copyright

The documentation and the software included with this product are copyrighted 2006 by Advantech Co., Ltd. All rights are reserved. Advantech Co., Ltd. reserves the right to make improvements in the products described in this manual at any time without notice. No part of this manual may be reproduced, copied, translated or transmitted in any form or by any means without the prior written permission of Advantech Co., Ltd. Information provided in this manual is intended to be accurate and reliable. However, Advantech Co., Ltd. assumes no responsibility for its use, nor for any infringements of the rights of third parties, which may result from its use.

Acknowledgements

Intel and Pentium are trademarks of Intel Corporation.

Microsoft Windows and MS-DOS are registered trademarks of Microsoft Corp.

All other product names or trademarks are properties of their respective owners.

Product Warranty (2 years)

Advantech warrants to you, the original purchaser, that each of its products will be free from defects in materials and workmanship for two years from the date of purchase.

This warranty does not apply to any products which have been repaired or altered by persons other than repair personnel authorized by Advantech, or which have been subject to misuse, abuse, accident or improper installation. Advantech assumes no liability under the terms of this warranty as a consequence of such events.

Because of Advantech's high quality-control standards and rigorous testing, most of our customers never need to use our repair service. If an Advantech product is defective, it will be repaired or replaced at no charge during the warranty period. For out-of-warranty repairs, you will be billed according to the cost of replacement materials, service time and freight. Please consult your dealer for more details.

If you think you have a defective product, follow these steps:

1. Collect all the information about the problem encountered. (For example, CPU speed, Advantech products used, other hardware and software used, etc.) Note anything abnormal and list any onscreen messages you get when the problem occurs.
2. Call your dealer and describe the problem. Please have your manual, product, and any helpful information readily available.
3. If your product is diagnosed as defective, obtain an RMA (return merchandise authorization) number from your dealer. This allows us to process your return more quickly.
4. Carefully pack the defective product, a fully-completed Repair and Replacement Order Card and a photocopy proof of purchase date (such as your sales receipt) in a shippable container. A product returned without proof of the purchase date is not eligible for warranty service.
5. Write the RMA number visibly on the outside of the package and ship it prepaid to your dealer.

Part No. 2002339211

Printed in Taiwan

Edition 2

July 2008

Declaration of Conformity

CE

This product has passed the CE test for environmental specifications when shielded cables are used for external wiring. We recommend the use of shielded cables. This kind of cable is available from Advantech. Please contact your local supplier for ordering information.

FCC Class A

Note: This equipment has been tested and found to comply with the limits for a Class A digital device, pursuant to part 15 of the FCC Rules. These limits are designed to provide reasonable protection against harmful interference when the equipment is operated in a commercial environment. This equipment generates, uses, and can radiate radio frequency energy and, if not installed and used in accordance with the instruction manual, may cause harmful interference to radio communications. Operation of this equipment in a residential area is likely to cause harmful interference in which case the user will be required to correct the interference at his own expense.

FM

This equipment has passed the FM certification. According to the National Fire Protection Association, work sites are classified into different classes, divisions and groups, based on hazard considerations. This equipment is compliant with the specifications of Class I, Division 2, Groups A, B, C and D indoor hazards.

Technical Support and Assistance

1. Visit the Advantech web site at www.advantech.com/support where you can find the latest information about the product.
2. Contact your distributor, sales representative, or Advantech's customer service center for technical support if you need additional assistance. Please have the following information ready before you call:
 - Product name and serial number
 - Description of your peripheral attachments
 - Description of your software (operating system, version, application software, etc.)
 - A complete description of the problem
 - The exact wording of any error messages

Warnings, Cautions and Notes

Warning! Warnings indicate conditions, which if not observed, can cause personal injury!



Caution! Cautions are included to help you avoid damaging hardware or losing data. e.g.



There is a danger of a new battery exploding if it is incorrectly installed. Do not attempt to recharge, force open, or heat the battery. Replace the battery only with the same or equivalent type recommended by the manufacturer. Discard used batteries according to the manufacturer's instructions.

Note! Notes provide optional additional information.



Document Feedback

To assist us in making improvements to this manual, we would welcome comments and constructive criticism. Please send all such - in writing to: support@advan-tech.com

Packing List

- MIC-3392 all-in-one single board computer x1
- Utility and user manual (PDF file) CD-ROM disc x1
- CPU Heat sink (Assembled) x1
- Thermal pad for CPU x1
- HDD tray (Assembled) x 1
- North Bridge Heat sink including a thermal PAD for north bridge component (Assembled) x 1
- Daughter board for SATA HDD (Assembled) x1 (Single PMC version only)
- PMC filler panel(s) (Assembled) x1 (Single PMC version) or x2 (Dual PMC version)
- Solder-side cover (Assembled) x1
- RJ45 to DB9 cable x1
- Several screws
- Warranty certificate document x1
- Safety Warnings: CE, FCC class A

If any of these items are missing or damaged, contact your distributor or sales representative immediately.

Safety Instructions

1. Read these safety instructions carefully.
2. Keep this User Manual for later reference.
3. Disconnect this equipment from any AC outlet before cleaning. Use a damp cloth. Do not use liquid or spray detergents for cleaning.
4. For plug-in equipment, the power outlet socket must be located near the equipment and must be easily accessible.
5. Keep this equipment away from humidity.
6. Put this equipment on a reliable surface during installation. Dropping it or letting it fall may cause damage.
7. The openings on the enclosure are for air convection. Protect the equipment from overheating. **DO NOT COVER THE OPENINGS.**
8. Make sure the voltage of the power source is correct before connecting the equipment to the power outlet.
9. Position the power cord so that people cannot step on it. Do not place anything over the power cord.
10. All cautions and warnings on the equipment should be noted.
11. If the equipment is not used for a long time, disconnect it from the power source to avoid damage by transient overvoltage.
12. Never pour any liquid into an opening. This may cause fire or electrical shock.
13. Never open the equipment. For safety reasons, the equipment should be opened only by qualified service personnel.
14. If one of the following situations arises, get the equipment checked by service personnel:
 15. The power cord or plug is damaged.
 16. Liquid has penetrated into the equipment.
 17. The equipment has been exposed to moisture.
 18. The equipment does not work well, or you cannot get it to work according to the user's manual.
 19. The equipment has been dropped and damaged.
 20. The equipment has obvious signs of breakage.
21. **DO NOT LEAVE THIS EQUIPMENT IN AN ENVIRONMENT WHERE THE STORAGE TEMPERATURE MAY GO BELOW -20° C (-4° F) OR ABOVE 60° C (140° F). THIS COULD DAMAGE THE EQUIPMENT. THE EQUIPMENT SHOULD BE IN A CONTROLLED ENVIRONMENT.**
22. **CAUTION: DANGER OF EXPLOSION IF BATTERY IS INCORRECTLY REPLACED. REPLACE ONLY WITH THE SAME OR EQUIVALENT TYPE RECOMMENDED BY THE MANUFACTURER, DISCARD USED BATTERIES ACCORDING TO THE MANUFACTURER'S INSTRUCTIONS.**
23. The sound pressure level at the operator's position according to IEC 704-1:1982 is no more than 70 dB (A).

DISCLAIMER: This set of instructions is given according to IEC 704-1. Advantech disclaims all responsibility for the accuracy of any statements contained herein.

Wichtige Sicherheitshinweise

1. Bitte lesen sie sich diese Hinweise sorgfältig durch.
2. Heben Sie diese Anleitung für den späteren Gebrauch auf.
3. Vor jedem Reinigen ist das Gerät vom Stromnetz zu trennen. Verwenden Sie keine Flüssig- oder Aerosolreiniger. Am besten dient ein angefeuchtetes Tuch zur Reinigung.
4. Die Netzanschlusssteckdose soll nahe dem Gerät angebracht und leicht zugänglich sein.
5. Das Gerät ist vor Feuchtigkeit zu schützen.
6. Bei der Aufstellung des Gerätes ist auf sicheren Stand zu achten. Ein Kippen oder Fallen könnte Verletzungen hervorrufen.
7. Die Belüftungsöffnungen dienen zur Luftzirkulation die das Gerät vor Überhitzung schützt. Sorgen Sie dafür, daß diese Öffnungen nicht abgedeckt werden.
8. Beachten Sie beim Anschluß an das Stromnetz die Anschlußwerte.
9. Verlegen Sie die Netzanschlusbleitung so, daß niemand darüber fallen kann. Es sollte auch nichts auf der Leitung abgestellt werden.
10. Alle Hinweise und Warnungen die sich am Geräten befinden sind zu beachten.
11. Wird das Gerät über einen längeren Zeitraum nicht benutzt, sollten Sie es vom Stromnetz trennen. Somit wird im Falle einer Überspannung eine Beschädigung vermieden.
12. Durch die Lüftungsöffnungen dürfen niemals Gegenstände oder Flüssigkeiten in das Gerät gelangen. Dies könnte einen Brand bzw. elektrischen Schlag auslösen.
13. Öffnen Sie niemals das Gerät. Das Gerät darf aus Gründen der elektrischen Sicherheit nur von autorisiertem Servicepersonal geöffnet werden.
14. Wenn folgende Situationen auftreten ist das Gerät vom Stromnetz zu trennen und von einer qualifizierten Servicestelle zu überprüfen:
 15. Netzkabel oder Netzstecker sind beschädigt.
 16. Flüssigkeit ist in das Gerät eingedrungen.
 17. Das Gerät war Feuchtigkeit ausgesetzt.
 18. Wenn das Gerät nicht der Bedienungsanleitung entsprechend funktioniert oder Sie mit Hilfe dieser Anleitung keine Verbesserung erzielen.
 19. Das Gerät ist gefallen und/oder das Gehäuse ist beschädigt.
 20. Wenn das Gerät deutliche Anzeichen eines Defektes aufweist.
21. **VORSICHT:** Explosionsgefahr bei unsachgemäßen Austausch der Batterie. Ersatz nur durch denselben oder einem vom Hersteller empfohlene-männlichen Typ. Entsorgung gebrauchter Batterien nach Angaben des Herstellers.
22. **ACHTUNG:** Es besteht die Explosionsgefahr, falls die Batterie auf nicht fachmännische Weise gewechselt wird. Verfangen Sie die Batterie nur gleicher oder entsprechender Type, wie vom Hersteller empfohlen. Entsorgen Sie Batterien nach Anweisung des Herstellers.
23. Der arbeitsplatzbezogene Schalldruckpegel nach DIN 45 635 Teil 1000 beträgt 70dB(A) oder weniger.

Haftungsausschluss: Die Bedienungsanleitungen wurden entsprechend der IEC-704-1 erstellt. Advantech lehnt jegliche Verantwortung für die Richtigkeit der in diesem Zusammenhang getätigten Aussagen ab.

Safety Precaution - Static Electricity

Follow these simple precautions to protect yourself from harm and the products from damage.

- To avoid electrical shock, always disconnect the power from your PC chassis before you work on it. Don't touch any components on the CPU card or other cards while the PC is on.
- Disconnect power before making any configuration changes. The sudden rush of power as you connect a jumper or install a card may damage sensitive electronic components.

Contents

Chapter 1	Hardware Configuration	1
1.1	Introduction	2
	Table 1.1: MIC-3392 Variants	2
1.2	Specifications	2
1.2.1	CompactPCI Bus Interface	2
1.2.2	CPU	3
1.2.3	Processor	3
	Table 1.2: Intel Processors	3
1.2.4	BIOS	3
1.2.5	Chipset	3
1.2.6	Memory	4
	Table 1.3: SODIMM Types (Non-ECC)	4
1.2.7	Ethernet	5
1.2.8	Storage interface	5
1.2.9	Serial ports	5
1.2.10	USB port	5
1.2.11	LEDs	5
1.2.12	Watchdog timer	5
1.2.13	Optional Rear I/O Modules	5
1.2.14	Mechanical and Environmental Specifications	6
1.2.15	Compact Mechanical Design	6
1.2.16	CompactPCI Bridge	6
1.2.17	I/O Connectivity	7
1.2.18	PMC (PCI Mezzanine Card) IEEE1386.1 Compliant	7
1.2.19	Hardware Monitor	7
1.2.20	Super IO	7
1.2.21	RTC and Battery	7
1.2.22	IPMI	7
1.2.23	HPET and IO/APIC	8
1.3	Functional Block Diagram	8
	Figure 1.1 MIC-3392 functional block diagram	8
1.4	Jumpers and Switches	9
	Table 1.4: MIC-3392 jumper descriptions	9
	Table 1.5: MIC-3392 switch descriptions	9
1.4.1	Jumper Settings	9
	Table 1.6: JP2 VGA output settings	9
	Table 1.7: JP14 PMC2 V(IO) settings	9
	Table 1.8: JP4 PMC1 PCI bus frequency settings	9
1.4.2	Clear CMOS (JP1)	10
	Table 1.9: JP1 Clear CMOS	10
1.4.3	Switch Settings	10
	Table 1.10: SW5-1 LAN for BMC	10
	Table 1.11: SW5-2 SATA HDD channel setting (single PMC)	10
	Table 1.12: SW5-2 SATA HDD channel setting (dual PMC)	10
	Table 1.13: SW5-3 & SW5-4: COM2 to console or BMC	11
	Table 1.14: SW6 IPMI programming setting	11
	Table 1.15: SW7 - Master/Drone mode setting	11
	Table 1.16: SW1: BMC Reset Button & Platform Reset Button	11
	Figure 1.2 MIC-3392 jumper, switch and connector locations	12
1.5	Connector Definitions	12
	Table 1.17: MIC-3392 connector descriptions	12
1.5.1	VGA Display Connector (VCN1 or rear I/O)	13
1.5.2	Serial Ports (CN9 and Rear I/O)	13
1.5.3	USB Connector (CN11/12 and Rear I/O)	13

1.5.4	CompactFlash Socket (CN10).....	13
1.5.5	SATA daughter board connector (CN4) (Single PMC only).....	13
1.5.6	Ethernet Configuration (RJ1/RJ2 or Rear I/O RJ1)	14
1.5.7	PMC Connector (J23 for PMC1, Jxx for PMC2)	14
1.5.8	SW1 (System reset and BMC reset button).....	14
1.6	Safety Precautions.....	14
1.7	Installing the CPU and Heatsink	15
	Figure 1.3 Complete assembly of CPU and heat sink.....	15
1.7.1	CPU & Heatsink Installation Steps	16
1.8	Battery Replacement	17
1.9	Software Support	17

Chapter 2 AMI BIOS Setup..... 19

2.1	Introduction	20
	Figure 2.1 Setup program initial screen.....	20
2.2	Entering Setup	21
	Figure 2.2 Press Del to run Setup	21
2.3	Main Setup.....	22
	Figure 2.3 Main setup screen	22
2.3.1	System time/System date.....	22
2.4	Advanced BIOS Features Setup.....	23
	Figure 2.4 Advanced BIOS features setup screen	23
2.4.1	CPU Configuration.....	24
	Figure 2.5 CPU Configuration	24
2.4.2	LAN & SMBus Configuration.....	25
	Figure 2.6 LAN & SMBus Configuration	25
	Table 2.1: Select SMBus mode.....	25
2.4.3	IDE Configuration	26
	Figure 2.7 IDE Configuration	26
2.4.4	Floppy Configuration.....	27
	Figure 2.8 Floppy Configuration	27
2.4.5	Super I/O Configuration	28
	Figure 2.9 Super I/O Configuration.....	28
2.4.6	ACPI Setting	29
	Figure 2.10ACPI Setting.....	29
2.4.7	Hardware Health Configuration	29
	Figure 2.11Hardware Health Configuration	29
2.4.8	Console Redirection Configuration	30
	Figure 2.12Configure Remote Access types and parameters....	30
2.5	PCI/PNP Setup	31
	Figure 2.13PCI/PNP Setup.....	31
2.5.1	Clear NVRAM	31
2.5.2	Plug and Play O/S	31
2.5.3	PCI Latency Timer	31
2.6	Boot Setup	32
	Figure 2.14Boot Setup.....	32
2.6.1	Boot Settings Configuration.....	32
	Figure 2.15Boot Settings Configuration.....	32
2.7	Security Setup.....	33
	Figure 2.16Password Configuration	33
2.8	Advanced Chipset Settings.....	34
	Figure 2.17Advanced Chipset Setting	34
2.8.1	North Bridge Chipset Configuration	34
	Figure 2.18North Bridge Configuration.....	34
2.8.2	South Bridge Configuration.....	35
	Figure 2.19South Bridge Configuration	35
2.9	Exit Option	36
	Figure 2.20Exit Option.....	36

2.9.1	Save Changes and Exit	36
2.9.2	Discard Changes and Exit	36
2.9.3	Load Defaults.....	36

Chapter 3 IPMI37

3.1	Introduction	38
3.2	Definitions	38
3.3	IPMI function list.....	38
3.3.1	IPMI Device Global Commands.....	39
	Table 3.1: Supported IPMI commands	39
3.3.2	BMC Device and Messaging Interfaces.....	39
	Table 3.2: H8S12C bus connection to NIC SMBus	39
	Table 3.3: NIC Interrupt.....	39
	Table 3.4: BMC Device and Messaging Commands.....	40
3.3.3	BMC Watchdog Timer Commands	40
	Table 3.5: BMC Watchdog Timer Commands.....	40
3.3.4	Chassis Device Commands.....	41
	Table 3.6: Chassis Device commands	41
3.3.5	Event Commands	41
	Table 3.7: Event commands.....	41
3.3.6	PEF and Alerting Commands	41
	Table 3.8: PEF and Alerting commands.....	41
3.3.7	SEL Device Commands.....	42
	Table 3.9: SEL Device commands	42
3.3.8	SDR Device Commands.....	42
	Table 3.10:SDR Device commands	42
3.3.9	FRU data.....	42
	Table 3.11:FRU Device commands.....	42
3.3.10	Sensors and Threshold configuration	43
	Table 3.12: Sensor List.....	43
	Table 3.14: Sensor Device Commands.....	44
	Table 3.13: Threshold values of sensors.....	44
3.3.11	Serial over LAN.....	44
	Table 3.15:LAN Device Commands	44
3.3.12	Serial/Modem Device Commands	44
	Table 3.16: Serial/Modem Device Commands	44
3.4	BMC Reset.....	45

Appendix A Pin Assignments47

A.1	J1 Connector.....	48
	Table A.1: J1 CompactPCI I/O.....	48
A.2	J2 Connector.....	49
	Table A.2: J2 CompactPCI I/O.....	49
A.3	J3 Connector.....	50
	Table A.3: J3 CompactPCI I/O (LPT, FDD, Parallel IDE, 2.16) .	50
A.4	J5 Connector.....	51
	Table A.4: J5 CompactPCI I/O (VGA, LAN, COM, USB, PS/2) .	51
A.5	Other Connectors.....	51
	Table A.5: VCN1 VGA Connector.....	51
	Table A.6: CN9 COM1 (RJ45) Connector.....	52
	Table A.7: CN4 & CN5 USB port 1 & port 2.....	52
	Table A.8: BT1 CMOS battery	52
	Table A.9: CN10 CF socket	52
	Table A.10:CN4 SATA daughter board connector.....	53
	Table A.11:RJ1 LAN1 Connector.....	53
	Table A.12:RJ1 LAN1 Indicator	53
A.5.1	M/D, PWR & IDE/Hot-swap LEDs.....	54

Appendix B **Programming the Watchdog Timer . 55**

B.1	Watchdog Timer Programming Procedure	56
-----	--	----

Appendix C **CPLD 57**

C.1	Features	58
C.2	CPLD I/O Registers	58
	Table C.1: LPC I/O registers address	58
C.2.1	Debug Message.....	58
	Table C.2: Debug_Code [7:0] (LPC I/O address: 80H).....	58
C.2.2	Watchdog Register	58
	Table C.3: Watchdog [7:0] (LPC I/O address: 443H).....	58
C.2.3	Watchdog Disable Register	59
	Table C.4: Watchdog [7:0] (LPC I/O address: 444H).....	59
	Table C.5: Version [7:0] (LPC I/O address: 445H).....	59
C.2.4	Geography Address (GA)	59
	Table C.6: GA [7:0] (LPC I/O address: 447H).....	59

Chapter 1

Hardware Configuration

This chapter describes how to
configure MIC-3392 hardware.

1.1 Introduction

The MIC-3392 is a high performance, power efficient CompactPCI single-board computer based on the Intel Core 2 Duo and Core Duo microprocessors. The MIC-3392 delivers breakthrough energy-efficient performance for CompactPCI platforms. The Intel Core 2 Duo provides enhanced energy-efficient performance to help equipment manufacturers optimally balance processing capabilities within power and space constraints. The advanced smart cache of Core Duo dynamically allocates the shared L2 cache across cores and optimizes use of memory subsystem bandwidth to accelerate out-of-order execution. A prediction mechanism reduces the time in-flight instructions have to wait for data. The new pre-fetch algorithms move data from system memory into fast L2 cache in advance of execution.

The Core Duo combines the benefits of two high-performance execution cores with intelligent power management features to deliver significantly greater performance per watt over previous Intel processors. The two execution cores share a high-performance, power-optimized 667 MHz front-side bus to access the same system memory. To save power, address and data buffers are turned off when there is no activity.

The MIC-3392 maximizes I/O throughput with PCI Express (PCIe) technology. It supports up to 4 GB of 667 MHz DDR2 memory provided by a combination of SO-DIMM and soldered DRAM (6.4 GB/sec throughput). It supports a fast Serial-ATA interface to an on-board hard drive or CompactFlash socket. The MIC-3392 is available in single or dual PMC variants with differing I/O combinations as listed in the table below.

Table 1.1: MIC-3392 Variants

Features	'A' model Single PMC	'B' model Dual PMC
LAN	2	1
COM	1	1
PMC	1	2
USB	2	-
VGA	1	-
CPU	-	-
On-board HDD	1	-
CF socket	1	1
SODIMM socket	1	1

1.2 Specifications

1.2.1 CompactPCI Bus Interface

The MIC-3392 is compliant with PICMG 2.0 Rev. 3.0. It supports a 64-bit / 66 MHz or 33 MHz PCI bus for up to 8 compactPCI slots at 3.3 V or 5 V VIO. The MIC-3392 is hot-swap compliant (PICMG 2.1) and conforms to the CompactPCI Packet Switching Backplane specification (PICMG 2.16) as well as the CompactPCI System Management Specification (PICMG 2.9).

The board can be configured as a system master or a drone board. In drone mode it only draws power from the CompactPCI backplane and is not active on the CompactPCI bus. However, PICMG 2.16 is still fully supported in this mode.

1.2.2 CPU

The MIC-3392 supports the latest Intel Core Duo/Solo and Intel Core 2 Duo processor family with clock frequencies up to 2.16 GHz and a Front-Side Bus (FSB) up to 667 MHz.

Intel Core Duo processors are validated with the Mobile Intel 945GM/945GME Express chipset. This chipset provides greater flexibility for developers of embedded applications by offering improved graphics and increased I/O bandwidth over previous Intel chipsets, as well as remote asset management capabilities, and improved storage speed and reliability.

Currently supported processors are listed in the table below. The Intel Core Duo consists of two cores and up to 2 MB L2 cache shared by both cores. The Intel Core 2 Duo consists of two cores, up to 4 MB L2 cache shared by both cores.

1.2.3 Processor

Table 1.2: Intel Processors

Core speed	Front-Side Bus speed	L2 cache	TDP	Package	
Core Duo (T2500)	2.0 GHz	667 MHz	2 MB	31 W	FCPGA
LV Core Duo (L2400)	1.66 GHz	667 MHz	2 MB	15 W	FCBGA
Core 2 Duo (T7400)	2.16 GHz	667 MHz	4 MB	34 W	FCPGA
LV Core 2 Duo (L7400)	1.5 GHz	667 MHz	4 MB	17 W	FCBGA

Note!  Because power consumption and thermal restrictions vary between different CompactPCI systems, please double check these items before installing a higher speed CPU not listed in the table above.

1.2.4 BIOS

An 8 Mbit Firmware Hub (FWH) contains a board-specific BIOS that is designed to meet industrial and embedded system requirements.

1.2.5 Chipset

The Mobile Intel 945GM Express / 945GME chipset provides excellent flexibility for developers of embedded applications by offering improved graphics and increased I/O bandwidth over previous Intel chipsets, as well as remote asset management capabilities and improved storage speed and reliability. Features include an integrated 32-bit 3D graphics engine based on Intel Graphics Media Accelerator 950 (Intel GMA 950) architecture.

The Mobile Intel 945GM Express/945GME chipset consists of the Intel 82945GM Graphics Memory Controller Hub (GMCH) and Intel I/O Controller Hub 7-M (ICH7-M). It delivers outstanding system performance through high bandwidth interfaces such as PCI Express, Serial ATA and Hi-Speed USB 2.0.

1.2.6 Memory

The MIC-3392 has up to 2 GB of onboard non-ECC DDR2 memory. In addition, an SODIMM socket supports up to 2 GB of the following types of memory.

Table 1.3: SODIMM Types (Non-ECC)

Brand	Size	Speed	Vendor PN	Memory
UG	512 MB	DDR2 533	UG64T6400L8SU-5AS	SEC 525 ZC05 K4T51083QC EDE406CB (64x8)
Transcend	256 MB	DDR2 533	119697-0060	SAMSUNG 52B K4T56083QF-ZCD5 BBE393BA (32x8)
	512 MB	DDR2 533	119833-0266	Infineon HYB18T512 800AF37 SVV39006 0526 (32x8)
	1 GB	DDR2 533	120048-0014	ELPIDA TWN E5108AE-5C-E 0517A9105 (64x8)
DSL	256 MB	DDR2 533	NA	ELPIDA JAPAN E5116AB-5C-E 05020W108 (32x16)
	512 MB	DDR2 533	NA	ELPIDA JAPAN E5116AB-5C-E (32x16)
	1 GB	DDR2 533	NA	ELPIDA TWN E5108AE-5C-E 0511009276 (64x8)
NEXS	512 MB	DDR2 533	NXBS64M64VJ-75	ELPIDA TWN E5108AE-5C-E 0525A9B1S (64x8)
	1 GB	DDR2 533	NXBS128M64VJ-75	ELPIDA TWN E5108AE-5C-E 0525A9B1S (64x8)
Apacer	256 MB	DDR2 533	78.82054.420	ELPIDA JAPAN E5116AB-5C-E 05050WPWA (64x8)
	512 MB	DDR2 533	78.92051.421	ELPIDA JAPAN E5108AB-5C-E 04520WR5Q (64x8)
	1 GB	DDR2 533	78.02051.423	ELPIDA TWN E5108AE-5C-E (64x8)
A-DATA	256 MB	DDR2 533	M20SS2F3G3410A1 BOZ	SAMSUNG 52B K4T56083QF-GCD5 (32x8)
	512 MB	DDR2 533	M20EL2G3H3410A1 BOZ	ELPIDA JAPAN E5108AB-5C-E (64x8)
	1 GB	DDR2 533	M20EL2G314430B1 BOZ	ELPIDA TWN E5108AE-5C-E (64x8)
Transcend (RoHS)	256 MB	DDR2 667	TS32MSQ64V6M	Infineon HYB18T512161BF-28 (32x16)
	512 MB	DDR2 667	TS64MSQ64V6J	SAMSUNG K4T51083QC ZCE6 (64x8)
	2 GB	DDR2 667	TS256MSQ64V6U	Micron 7GEIID9HNL
	1 GB	DDR2 667	TS128MSQ64V6J	SAMSUNG K4T51083QC ZCE6 (64x8)
Apacer (RoHS)	512 MB	DDR2 667	78.92G63.422	ELPIODA E5108AG-6E-E (64x8)
	1 GB	DDR2 667	78.02G63.423	ELPIODA E5108AGBG-6E-E (64x8)
DSL (RoHS)	256 MB	DDR2 667	NA	ELPIDA E5116AF-6E-E (32x16)
	512 MB	DDR2 667	NA	ELPIDA E5108AGBG-6E-E (64x8)
	1 GB	DDR2 667	NA	ELPIDA E5108AGBG-6E-E (64x8)
UG (RoHS)	512 MB	DDR2 667	UG64T6400L8SU-6AS	ELPIDA E5108AE-6E-E (32x16)
	1 GB	DDR2 667	UG12T6400L8SU-6AP	ELPIDA E5108AG-6E-E (32x16)

1.2.7 Ethernet

The MIC-3392 uses two Intel 82573E LAN chips to provide 10/100/1000Base-T Ethernet connectivity (LAN1 & LAN2) and one Intel 82562GT LAN chip to provide 10/100Base-T Ethernet connectivity (LAN3) via rear I/O. Optional settings for the source of each individual Gigabit Ethernet port can be selected in the BIOS menu. These are mutually exclusive and can be any one of:

- Front I/O (RJ-45)
- Rear I/O (Rear Transition Module)
- PICMG 2.16

1.2.8 Storage interface

The MIC-3392 supports two SATA interfaces and one IDE channel. The SATA1 interface can be routed to an onboard 2.5" SATA hard disk drive or to the rear I/O module via the J3 connector. The onboard SATA port is only available on the single PMC version of the MIC-3392. The SATA2 interface is connected to the rear I/O module via the J5 connector and is reserved for user customized designs. Currently, Advantech's compatible RIO modules provide the SATA1 interface. The MIC-3392 also supports one IDE channel. The master is reserved for an onboard CompactFlash disk drive (type 1). The slave is connected to a rear I/O module via the J3 connector.

1.2.9 Serial ports

One RJ-45 COM1 port (RS-232 interface) is provided on the front panel. A COM2 port is routed to a rear I/O module via the J5 connector.

1.2.10 USB port

Two USB 2.0/1.1 compliant ports with fuse protection are provided. Both ports are routed to front panel connectors on the MIC-3392A (single-PMC board variant) and to the rear I/O module via the J5 connector on both the single-PMC and dual-PMC board variants.

1.2.11 LEDs

LEDs are provided on the front panel as follows:

- One bi-color LED (blue/yellow) indicates hot-swap status. Blue indicates that the board may be safely removed from the system and yellow indicates HDD activity.
- One green LED provides power status and a further green LED indicates "Master or Drone" mode. Green indicates that the board is in "Master" mode and when the LED is off the board is in "Drone" mode.

1.2.12 Watchdog timer

An onboard watchdog timer provides system reset capabilities via software control. The programmable time interval is from 1 to 255 seconds.

1.2.13 Optional Rear I/O Modules

A number of rear I/O modules are available with different I/O options:

- RIO-3310AE: 6U cPCI Rear I/O Module without SCSI
- RIO-3310S-A1E: 6U cPCI Rear I/O Module (Internal SCSI connectors)
- RIO-3310S-A2E: 6U cPCI Rear I/O Module (External SCSI connectors)

1.2.14 Mechanical and Environmental Specifications

- **Operating temperature:** 0 ~ 55° C (32 ~ 122° F)

Note! *The operating temperature range of the MIC-3392 depends on the installed processor and the airflow through the chassis.*



- **Storage Temperature:** -20 ~ 60° C (-4 ~ 140° F).
- **Humidity (Non-operating):** 5 ~ 95% @ 60° C (non-condensing)
- **Power Consumption:** (Intel Core 2 Duo and 2 GB memory)
+5 V @ 7.16 A; +3.3 V @ 3.17 A; +12 V @ 0.40 A
- **Board size:** 233.35 x 160 mm (6U size), 1-slot (4 TE) wide
- **Weight:** 0.8 kg (1.76 lb)
- **Shock:** 20 G (operating); 50 G (non-operating)
- **Random vibration:** 1.5 Grms (operating), 2.0 Grms (non-operating)

1.2.15 Compact Mechanical Design

The MIC-3392 has a specially designed CPU heat sink to enable fanless operation. Forced air cooling in the chassis is needed for operational stability and reliability.

1.2.16 CompactPCI Bridge

The MIC-3392 uses a PLX PCI-6254 (Hint HB6) universal bridge as a gateway to an intelligent subsystem. When configured as a system controller, the bridge acts as a standard transparent PCI-to-PCI bridge. As a peripheral controller it allows the local MIC-3392 processor to configure and control the onboard local subsystem independently from the CompactPCI bus host processor. The MIC-3392 local PCI subsystem is presented to the CompactPCI bus host as a single CompactPCI device. Finally, when the MIC-3392 is in drone mode, the PLX PCI-6254 is electrically isolated from the CompactPCI bus. The MIC-3392 receives power from the backplane, supports rear I/O and supports PICMG 2.16. Consult the PLX PCI-6254 (Hint HB6) datasheet for more details. The PLX PCI-6254 PCI bridge provides the following features:

- **PCI Interface**
 - Full compliance with the PCI Local Bus Specification, Revision 2.2
 - Supports 3.3 V or 5 V VIO operation
 - Concurrent local and CompactPCI bus operation
- **Buffer Architecture**
 - Queuing of multiple transactions in either direction
 - 256 bytes of posted write (data and address) buffering in each direction and 256 bytes of read data buffering in each direction
- **Configuration Register and Control/Status Registers (CSRs)**
 - Two sets of standard PCI configuration registers for local and CompactPCI interfaces, accessible from either the local or CompactPCI interface
 - Three 32-bit base address configuration registers mapping the CSRs
- **Transaction Forwarding**
 - Three primary interface base address configuration registers for downstream forwarding with programmable size and prefetch for all three address ranges
 - Direct offset address translation for downstream memory and I/O transactions
 - Three secondary interface address ranges for upstream forwarding, with programmable size and prefetch for all three address ranges

1.2.17 I/O Connectivity

Front panel I/O is provided by two RJ-45 Gigabit Ethernet ports, one RJ-45 COM port, two USB 2.0 ports, one VGA connector, and one PMC cutout. On the dual-PMC version only one RJ-45 Gigabit Ethernet Port and one RJ-45 COM port are available on the front panel due to the space taken by the second PMC cutout.

Onboard I/O consists of one IDE channel to a Compact Flash socket and additionally on the single-PMC version of the MIC-3392, one SATA channel can be connected to a 2.5" SATA HDD. Rear I/O connectivity is available via the following CompactPCI connectors:

- **J3:** First SATA port, one IDE slave port, one floppy port, one printer port, and two Gigabit Ethernet links to the backplane for PICMG 2.16.
- **J5:** Second SATA port, 10/100 LAN port, two USB ports (same ports as on the front panel), one keyboard & mouse connector, two COM ports, a VGA port and two Gigabit Ethernet LAN port for Rear I/O board.

The MIC-3392 provides two Gigabit Ethernet ports that can be routed to the front panel, the rear transition module or the PICMG 2.16 packet switched backplane.

1.2.18 PMC (PCI Mezzanine Card) IEEE1386.1 Compliant

Additional I/O or co-processing functionality is supported by add-on PMC modules. The MIC-3392 supports up to two PMC sites that are fully compliant with the IEEE1386.1 PCI Mezzanine Card specification. PMC1 supports a 64-bit / 66 MHz PCI bus interface whilst PMC2 supports a 32-bit / 33 MHz PCI bus interface. PMC1 supports 3.3 V VIO only, whereas PMC2 supports both 3.3 V and 5 V VIO.

The two-layer front panel design complies with IEEE 1101.10. Connectors are firmly screwed to the front panel, and a shielding gasket is attached to the panel edge. This reduces emissions and increases protection from external interference.

1.2.19 Hardware Monitor

Two Hardware Monitors (W83782D) are available to monitor critical hardware parameters. One is attached to the ICH7 and the other is connected to the Baseboard Management Controller (BMC) to monitor CPU temperature core voltage information.

1.2.20 Super IO

The MIC-3392 Super I/O device provides the following legacy PC devices:

- The serial port COM1 is connected to the rear I/O module or front panel
- The serial port COM2 is connected to the rear I/O module or BMC
- The parallel port is routed to the rear I/O module
- The FDD is routed to the rear I/O module
- The keyboard and mouse is routed to the rear I/O module

1.2.21 RTC and Battery

The RTC module keeps the date and time. On the MIC-3392 the RTC circuitry is connected to a battery source (CR2032M1S8-LF, 3 V, 210 mA).

1.2.22 IPMI

The MIC-3392 uses the Intelligent Platform Management Interface (IPMI) to monitor the health of an entire system. A Renesas H8S/2167 microcontroller provides BMC functionality to interface between system management software and platform hardware. The MIC-3392 implements fully-compliant IPMI 2.0 functionality and conforms to the PICMG 2.9 R1.0 specification. The IPMI firmware is based on proven technology from Avocent. Full IPMI details are covered in Chapter 3.

1.2.23 HPET and IO/APIC

The MIC-3392's built-in south bridge, the ICH7, provides features to support High Precision Event Timer (HPET) registers and I/O Advanced Programmable Interrupt Controller (APIC). The ICH7 timer registers are memory-mapped in a non-indexed scheme. The choice of address range will be selected by configuration bits in the HPET. The ICH7 incorporates an APIC that can be used in either a uni-processor or multi-processor system, like the standard ISA-compatible PIC used in a uni-processor system.

1.3 Functional Block Diagram

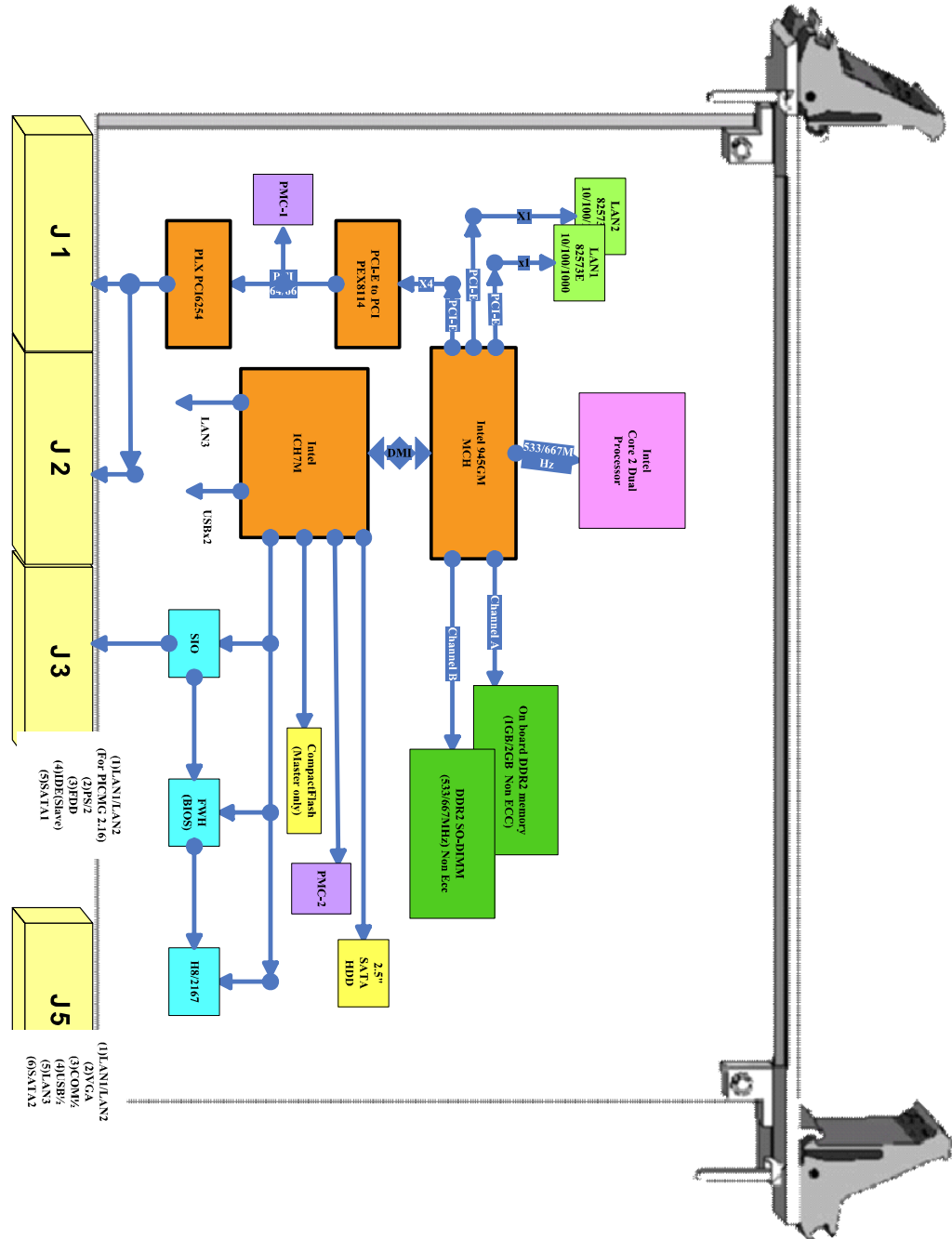

Figure 1.1 MIC-3392 functional block diagram

1.4 Jumpers and Switches

Table 1.4 and table 1.5 list the jumper and switch functions. Figure 1.2 illustrates the jumper and switch locations. Read this section carefully before changing the jumper and switch settings on your MIC-3392 board.

Table 1.4: MIC-3392 jumper descriptions

Number	Function
JP1	Clear CMOS
JP2	VGA Output Setting
JP14	PMC2 V(IO) setting
JP4	PMC1 PCI bus frequency setting

Table 1.5: MIC-3392 switch descriptions

Number	Function
SW5-1	LAN for BMC
SW5-2	SATA HDD channel Setting
SW5-3 & SW5-4	COM2 to console or BMC setting
SW6	IPMI programming / console setting
SW7	Master/Drone

1.4.1 Jumper Settings

Table 1.6: JP2 VGA output settings

Default	Front Panel	1-2	
	RTM	2-3	

Table 1.7: JP14 PMC2 V(IO) settings



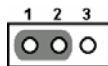
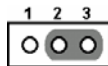

Default	3.3 V	2-3	
	5 V	1-2	

Table 1.8: JP4 PMC1 PCI bus frequency settings

Default	66 MHz	open	
	33 MHz	closed	

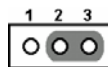
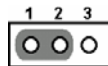

Note!  The MIC3392 supports auto-detection of PMC1 PCI bus frequency. This jumper should be used for manual configuration in combination with non compliant PMC modules, only.

1.4.2 Clear CMOS (JP1)

This jumper is used to erase CMOS data and reset the system BIOS information. Follow the procedures below to clear the CMOS.



1. Turn off the system.
2. Close jumper JP1 (1-2) for about 3 seconds.
3. Set jumper JP1 as Normal.
4. Turn on the system. The BIOS is reset to its default setting.

Table 1.9: JP1 Clear CMOS

Default	Normal	open	
	Clear CMOS	closed	

1.4.3 Switch Settings

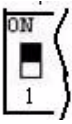
Table 1.10: SW5-1 LAN for BMC

Default	LAN2	on	
	LAN3 (reserved)	off	

SW5-1 selects the LAN port that is used for Serial Over LAN (SoL) functionality. The 10/100 LAN3 port is routed to the rear I/O but is not currently implemented on standard Advantech Rear I/O modules.

Table 1.11: SW5-2 SATA HDD channel setting (single PMC)



Default	On board	on	
	RTM	off	

Table 1.12: SW5-2 SATA HDD channel setting (dual PMC)

Default	RTM	on	
---------	-----	----	---

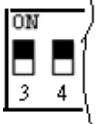
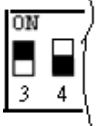
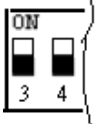

SW5-2 selects the routing of SATA channel 0 to either the onboard HDD socket or Rear IO module.

Table 1.13: SW5-3 & SW5-4: COM2 to console or BMC

	SW5-3	SW5-4	
SIO COM2 to BMC (Default)	On	On	
RIO COM2 to BMC	On	Off	
SIO COM2 to RIO	Off	Off	

When COM2 is not used as a console interface, it is used to communicate BMC information via the onboard SIO COM2 or RIO COM2. SW5-3 and SW5-4 determine whether COM2 is routed via SIO COM2 or RIO COM2. Three modes are available. SIO COM2 to BMC is the default.

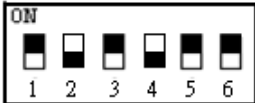
Table 1.14: SW6 IPMI programming setting

BMC firmware programmable	ON OFF ON OFF ON ON	
Default	BMC to console	
	OFF ON OFF ON OFF OFF	

When COM2 is connected to the BMC, the BMC firmware can be re-programmed by setting switch 6 to “BMC firmware programmable” mode.

Table 1.15: SW7 - Master/Drone mode setting

Default	Master	
	ON ON	
	Drone	
	OFF OFF	

The MIC-3392 default setting is Master.

Table 1.16: SW1: BMC Reset Button & Platform Reset Button

SW1-1	BMC Reset
SW1-2	Reset (Platform Reset)

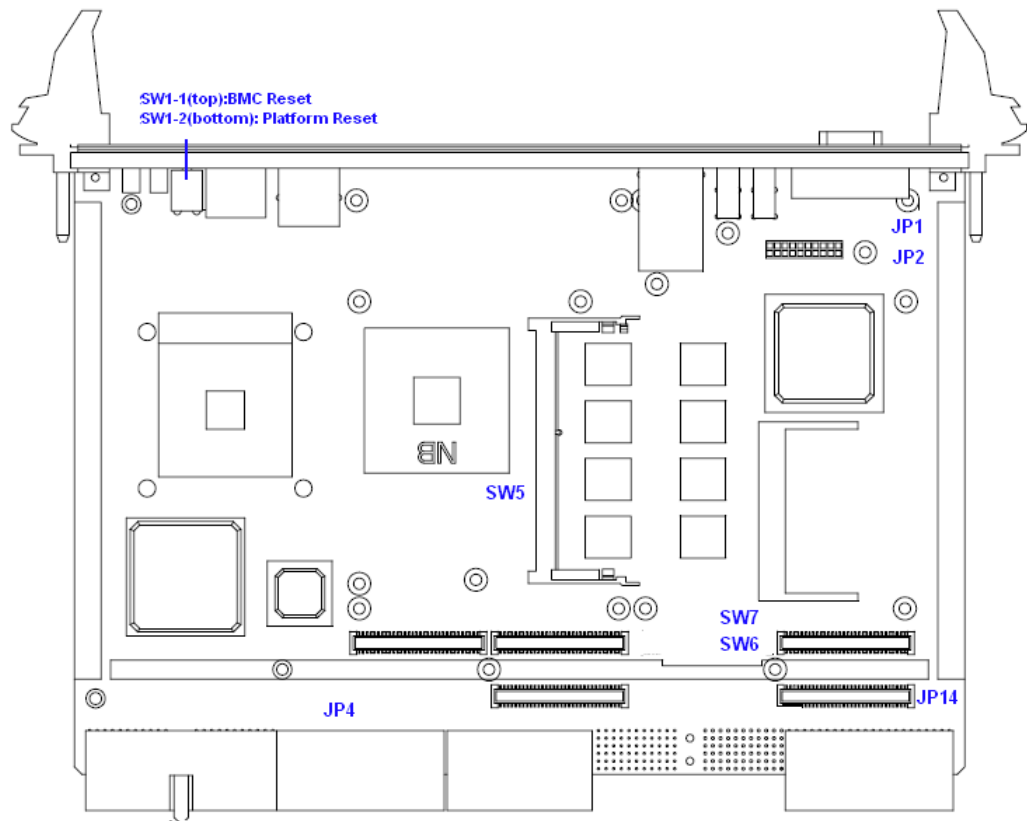

Figure 1.2 MIC-3392 jumper, switch and connector locations

1.5 Connector Definitions

Onboard connectors link to external devices such as hard disk drives, keyboards or floppy drives. Table 1.11 lists the function of each connector and Figure 1.2 illustrates each connector location.

Table 1.17: MIC-3392 connector descriptions

Number	Function
VCN1	VGA Connector
CN9	COM1 (RJ45)
CN11	USB port 1
CN12	USB port 2
BT1	CMOS Battery
CN10	CompactFlash socket
CN4	SATA daughter board connector
RJ1	LAN1 Connector
RJ2	LAN2 Connector
J1/J2	Primary CompactPCI bus
J3/J5	Rear I/O transition
DDR2 Channel B	SODIMM socket

1.5.1 VGA Display Connector (VCN1 or rear I/O)

The MIC-3392 incorporates the Intel 945GM/GME Graphic Memory Controller Hub (GMCH). The Intel Graphics Media Accelerator 950 (Intel GMA 950) graphics core is an intelligent and responsive graphics engine built into the chipset. This integration provides incredible visual quality, faster graphics performance and flexible display options without the need for a separate graphics card. The Intel GMA 950 operates at 256-bit core speeds of up to 400 MHz. The GMA 950 graphics core supports a bandwidth of up to 10.6 GB/sec with up to 224 MB of DDR2 667 video memory. The maximum resolution is 2048 x 1536 at 75 Hz.

The VCN1 connector of MIC-3392 and the VCN1 connector of the corresponding rear I/O board both provide DB-15 connectors for VGA monitors. The system monitor display is routed to either the front panel or the rear I/O module depending on the position of jumper JP2.

1.5.2 Serial Ports (CN9 and Rear I/O)

The MIC-3392 provides two serial ports. COM1 is available as an RS-232 interface via an RJ-45 connector on the front panel (CN9). An RJ-45 to DB-9 adaptor cable is provided in the MIC-3392 accessories to facilitate connectivity to external console or modem devices. Both the COM1 and COM2 ports are connected to the RIO-3310 series of rear I/O boards. The BIOS Advanced Setup program covered in Chapter 2 provides a user interface for features such as enabling or disabling the ports and setting the port address. Many serial devices implement the RS-232 standard in different ways. If you are having problems with a serial device, be sure to check the pin assignments for the connector. The IRQ and address range for both ports are fixed. However, if you wish to disable the port or change these parameters later, you can do this in the system BIOS setup.

1.5.3 USB Connector (CN11/12 and Rear I/O)

The MIC-3392 provides four Universal Serial Bus (USB) 2.0 channels. Two front panel USB ports CN11 and CN12 are available on the single PMC variant of the MIC-3392. Two USB channels are routed to rear I/O via the J5 connector. The USB interface provides complete plug and play, hot attach/detach for up to 127 external devices. The MIC-3392 USB interface complies with USB specification rev. 2.0 and is fuse protected (5 V @ 1.1 A). The USB interface can be disabled in the system BIOS setup. The USB controller default is set to "Enabled".

1.5.4 CompactFlash Socket (CN10)

The MIC-3392 features an on-board Compact Flash mass storage device connector. When populated with a flash disk it appears to the user as an intelligent ATA (IDE) disk drive with the same functionality and capabilities as a "rotating media" IDE hard drive. The MIC-3392 BIOS includes an option to allow the board to boot from the flash disk. The CompactFlash socket is connected to the IDE interface and 5 V power. UltraDMA is supported and has been tested on a number of devices from different manufacturers. Please contact your local support office in the unlikely event that you have any interoperability issues.

1.5.5 SATA daughter board connector (CN4) (Single PMC only)

The MIC-3392 provides two SATA interfaces: SATA1 channel via CN4 connects to the onboard SATA HDD or via the J3 connector to a rear I/O board when selected by switch SW5-2.

1.5.6 Ethernet Configuration (RJ1/RJ2 or Rear I/O RJ1)

The MIC-3392 is equipped with two high performance, PCI-Express based, network interface controllers which provide fully compliant IEEE 802.3u 10/100/1000Base-TX Ethernet interfaces. Users can select front panel, rear I/O or PICMG 2.16 connectivity via the BIOS. Users can choose the LAN1 and LAN2 either via the front panel RJ-45 connectors (RJ1 and RJ2) or the RJ-45 connector (RJ1) on the rear I/O module. The medium type can be configured via software included on the accompanying utility CD-ROM. Furthermore, the MIC-3392 supports the PICMG 2.16 Packet Switching Backplane Specification via the J3 connector.

1.5.7 PMC Connector (J23 for PMC1, Jxx for PMC2)

The MIC-3392 supports one or two PCI Mezzanine Cards (commonly known as PMCs or PMC modules). PMC1 connects to a 64-bit / 66 MHz, 3.3 V PCI bus. PMC2 connects to a 32-bit / 33 MHz PCI bus and is only available on the dual PMC version of the MIC-3392. Front panel access is provided for the PMCs that require I/O connectivity.

1.5.8 SW1 (System reset and BMC reset button)

The MIC-3392 provides a system reset button located on the front panel. The system reset button resets all payload and application-related circuitry. It does not reset the system management (IPMI) related circuitry. A separate BMC reset button on the front panel is provided for the BMC and related hardware.

1.6 Safety Precautions

Follow these simple precautions to protect yourself from harm and the products from damage.

- To avoid electric shock, always disconnect the power from your CompactPCI chassis before you work on it. Don't touch any components on the CPU board or other boards while the CompactPCI chassis is powered.
- Disconnect power before making any configuration changes. The sudden rush of power as you connect a jumper or install a board may damage sensitive electronic components.
- Always ground yourself to remove any static charge before you touch your CPU board. Be particularly careful not to touch the chip connectors.
- Modern integrated electronic devices, especially CPUs and memory chips, are extremely sensitive to static electric discharges and fields. Keep the board in its antistatic packaging when it is not installed in the chassis, and place it on a static dissipative mat when you are working with it. Wear a grounding wrist strap for continuous protection.

1.7 Installing the CPU and Heatsink

The MIC-3392 supports Intel Core Duo/Solo and Core 2 Duo processors. Advantech has designed a heat sink to meet the critical environmental conditions and size limitations of the MIC-3392 (see figure 1.3). Advantech also provides larger heat sinks as an option to support stricter operation environments. Application of such heat sinks may lead to restrictions and/or unavailability of other features of the MIC3392. Contact an Advantech local sales office or distributor for more information.

The MIC-3392 should be fastened to a heat sink supporting the Intel Core 2 Duo. When the user installs the CPU, the following steps should be followed:

1. Remove the screws from the solder side cover. During this step, the front panel should also loosen. Be careful not to damage the SBC during disassembly.
2. Remove the last four screws from the heat sink, and then loosen the heat sink for CPU installation. Apply the silicone heat sink compound, found in the accessory bag, to the CPU.
3. Follow the reverse procedure to replace the heat sink and solder side cover.

Note! *If your product comes with a processor in a soldered μ FCBGA package, please add a different heat sink. You need to insert a heat pad between the processor and the heat sink. The heat pad is provided in the accessory bag. The heat pad should be positioned between the heat sink and the CPU. The heat pad is fragile, so please be careful during disassembly. If you are using a heat pad other than the one issued by Advantech, be aware that it may not absorb a sufficient amount of heat.*

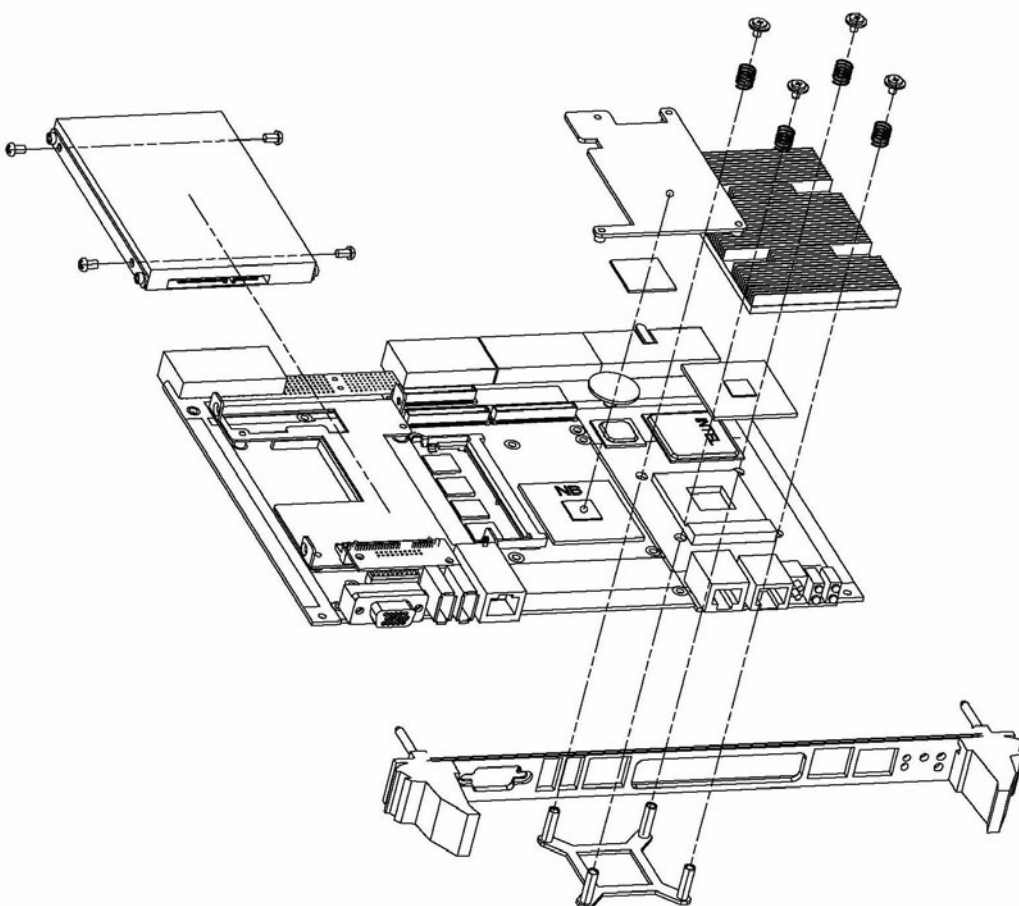

Figure 1.3 Complete assembly of CPU and heat sink

1.7.1 CPU & Heatsink Installation Steps

The MIC-3392 contains electrostatically sensitive devices. Please discharge your clothing before touching the assembly. Do not touch components or connector pins. We recommend that you perform assembly at an anti-static workbench.

1. Check that the following components are close at hand:
 - 1 x CPU
 - Thermal paste
 - 1 x Heatsink
 - 4 x screws
 - 4 x springs



2. Apply thermal paste to the top of the CPU die.
3. On the CPU interposer socket, turn the top screw to the “open” direction, to ensure that it is in the “unlock” position.



4. Carefully orient the CPU to the interposer socket



5. Turn the top screw to the “close” position to lock the processor in the socket.



Note! Match the corner of the interposer socket to the corner of the processor with triangle mark.



6. Align the screw holes on the heatsink with the spacers on the PCB and place the heatsink on the processor.

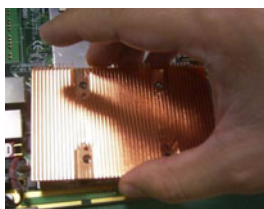

7. Fasten the heatsink to the base plate.



1.8 Battery Replacement

The battery model number is CR2032M1S8-LF, a 3 V, 210 mAh battery. Replacement batteries may be purchased from Advantech and replaced as described in the instructions below.

Order the battery from Advantech using the following part number:

1750129010 -- BATTERY 3V/210 mAh with WIRE ASS'YCR2032M1S8-LF

1. Remove the battery from the board by unplugging the connector and pulling away the battery cover from the board.



2. Apply adhesive to the replaced battery cover and re-glue it to the board. Finally, replace the connector

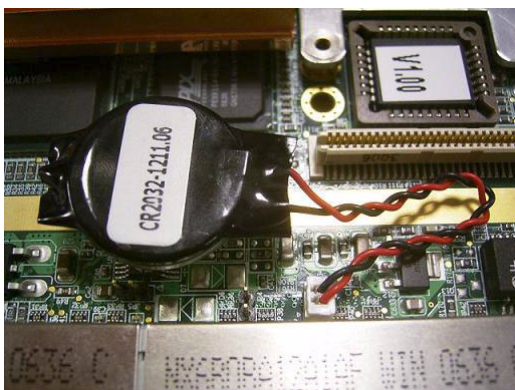

1.9 Software Support

Windows XP, Windows 2003, Windows Vista and Fedora Linux 6 have been fully tested on the MIC-3392. Please contact your local sales representative for details on support for other operating systems.

Chapter 2

AMI BIOS Setup

This chapter describes how to configure the AMI BIOS.

2.1 Introduction

The AMI BIOS has been customized and integrated into many industrial and embedded motherboards for over a decade. This section describes the BIOS which has been specifically adapted to the MIC-3392. With the AMI BIOS Setup program, you can modify BIOS settings and control the special features of the MIC-3392. The Setup program uses a number of menus for making changes and turning the special features on or off. This chapter describes the basic navigation of the MIC-3392 setup screens.

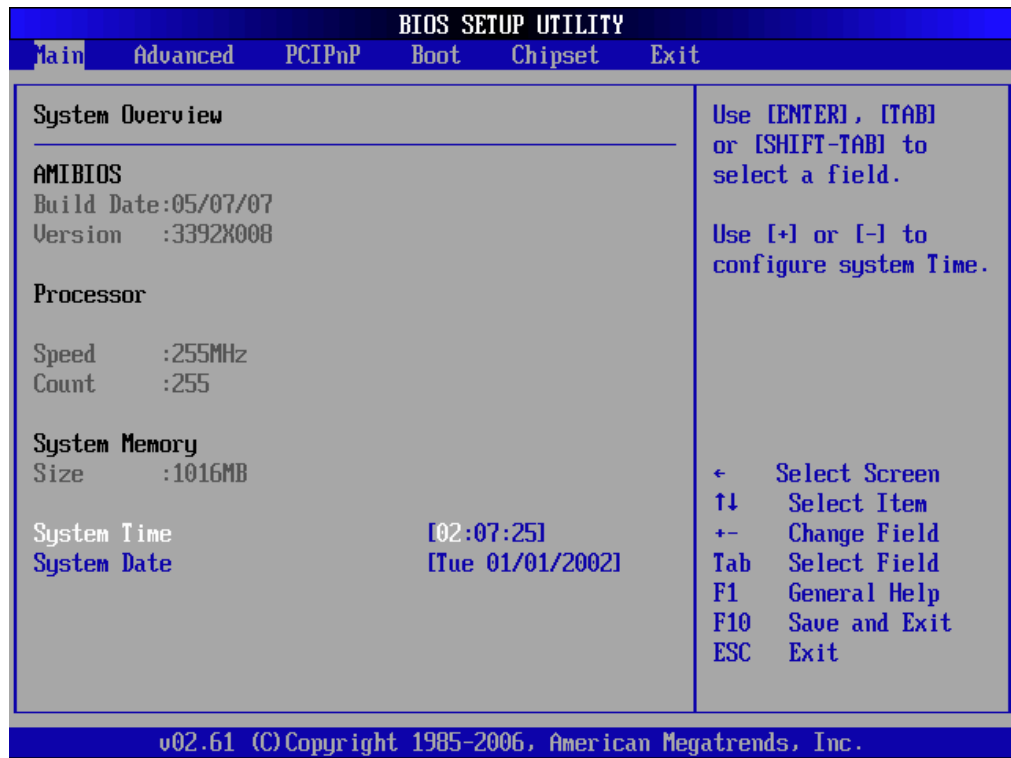

Figure 2.1 Setup program initial screen

The BIOS ROM has a built-in Setup program that allows users to modify the basic system configuration. This type of information is stored in battery-backed up CMOS so it retains the Setup information when the power is turned off.

2.2 Entering Setup

Turn on the computer and check for the “patch” code. If there is a number assigned to the patch code, it means that BIOS supports your CPU. If there is no number assigned to the patch code, please contact an Advantech application engineer to obtain an up-to-date patch code file. This will ensure that your CPU's system status is valid. After ensuring that you have a number assigned to the patch code, press and you will immediately be allowed to enter Setup.

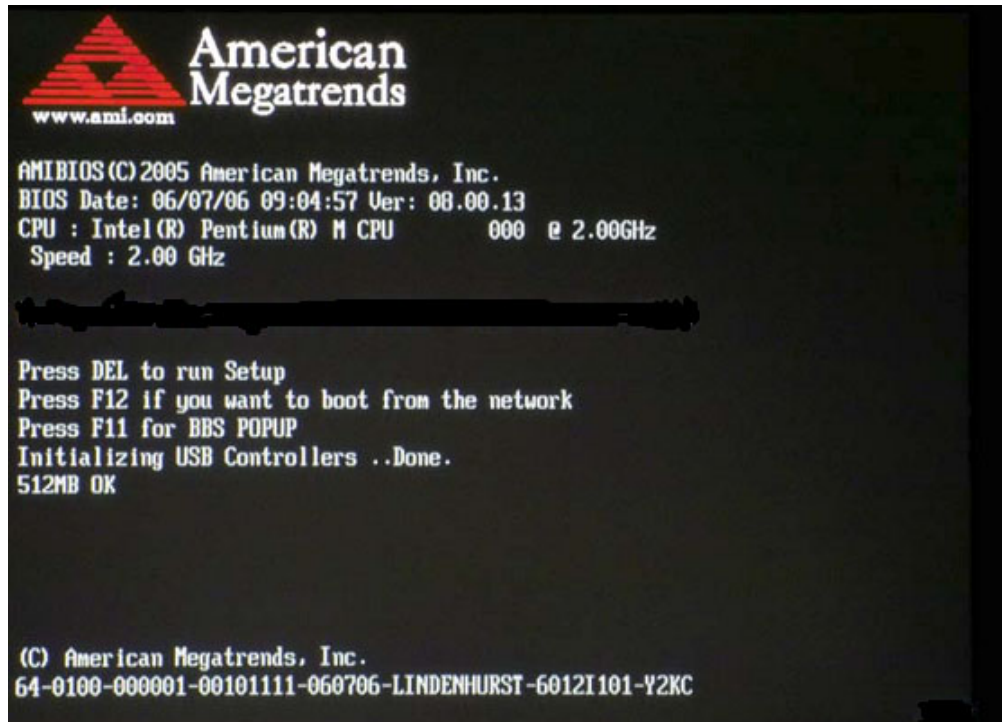

Figure 2.2 Press Del to run Setup

2.3 Main Setup

When you first enter the BIOS Setup Utility, you will enter the Main setup screen. You can always return to the Main setup screen by selecting the Main tab. Two main setup options are described in this section. The main BIOS setup screen is shown below.

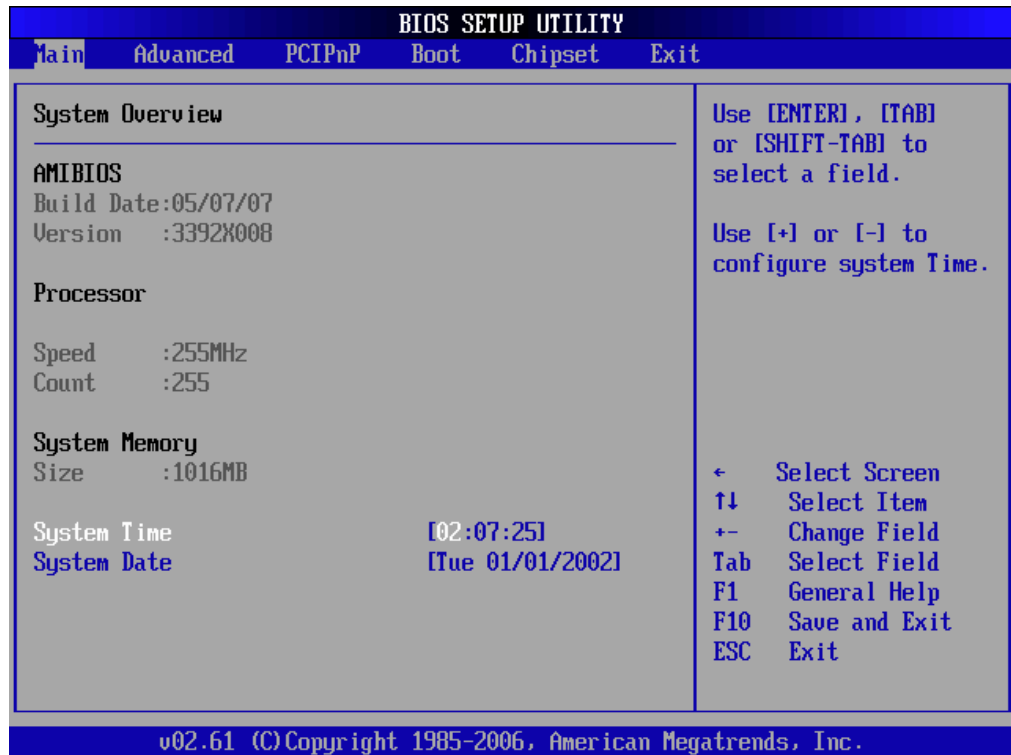

Figure 2.3 Main setup screen

The main BIOS setup menu screen has two main frames. The left frame displays all the options that can be configured. “Grayed-out” options cannot be configured whilst options in blue can. The right frame displays the key legend. Above the key legend is an area reserved for a text message. When an option is selected in the left frame, it is highlighted in white. Often a text message will accompany it.

2.3.1 System time/System date

Use this option to change the system time and date. Highlight System Time or System Date using the <Arrow> keys. Enter new values through the keyboard. Press the <Tab> key or the <Arrow> keys to move between fields. The date must be entered in MM/DD/YY format. The time is entered in HH:MM:SS format.

2.4 Advanced BIOS Features Setup

Select the Advanced tab from the MIC-3392 setup screen to enter the Advanced BIOS Setup screen. You can select any of the items in the left frame of the screen, such as CPU Configuration, to go to the sub menu for that item. You can display an Advanced BIOS Setup option by highlighting it using the <Arrow> keys. All Advanced BIOS Setup options are described in this section. The Advanced BIOS Setup screen is shown below. The sub menus are described on the following pages.

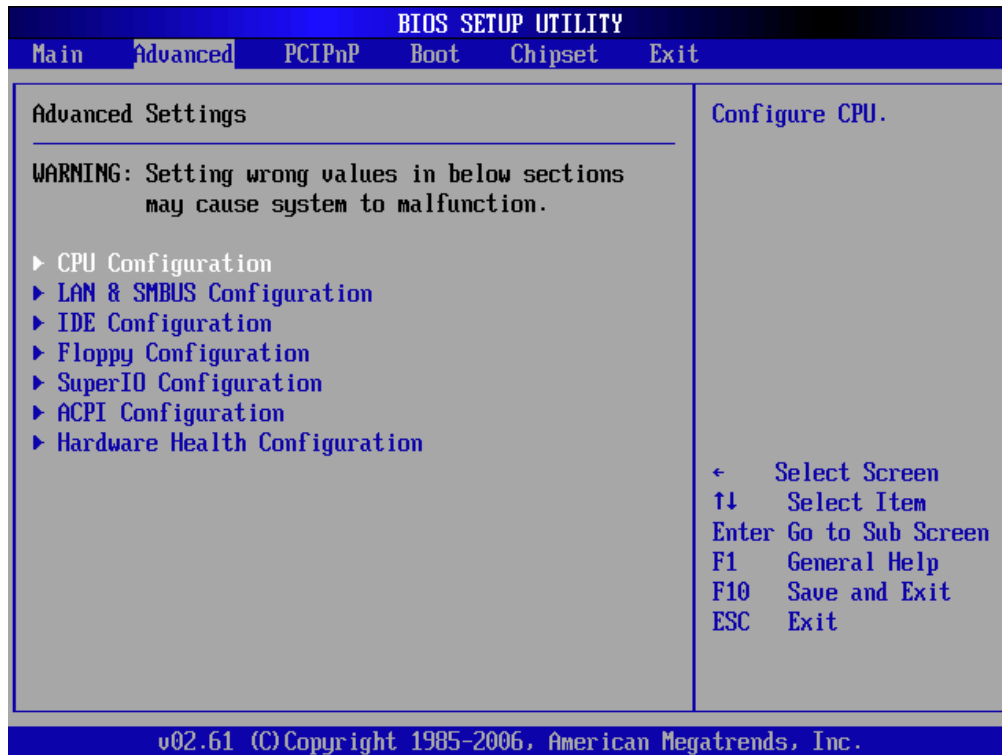

Figure 2.4 Advanced BIOS features setup screen

2.4.1 CPU Configuration

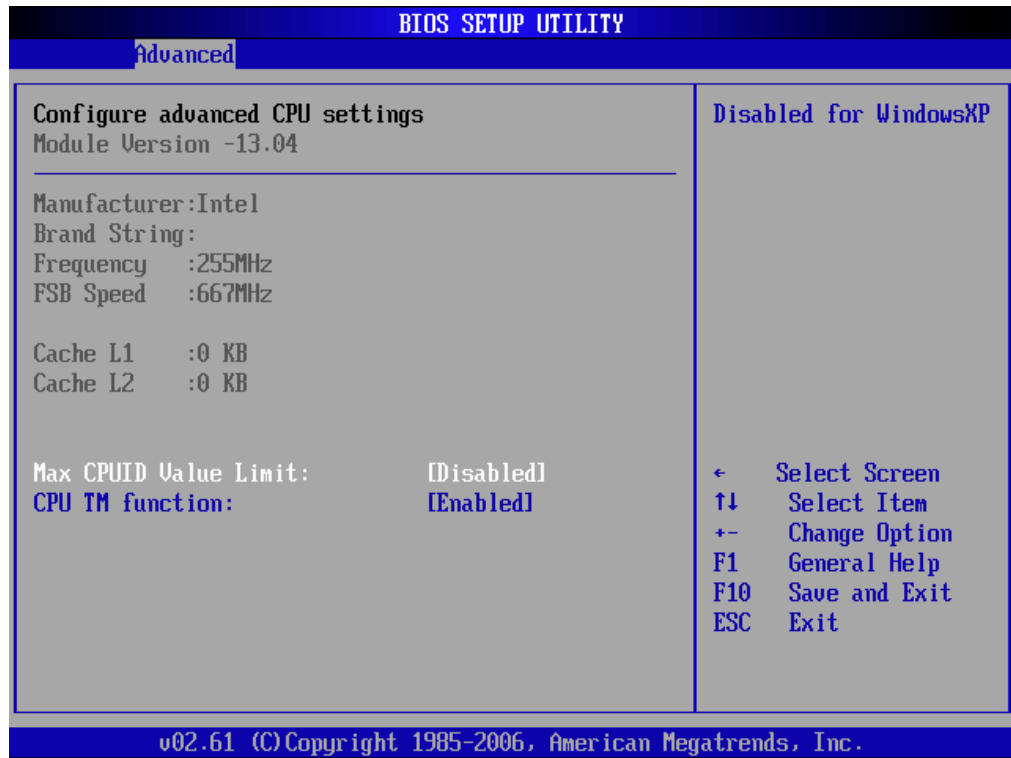

Figure 2.5 CPU Configuration

2.4.1.1 Max CPUID Value Limit

It is recommended that you leave this value at the default setting of Disabled.

Please note that this BIOS feature currently only allows the Intel Pentium 4 processor with Hyper-Threading Technology to work with operating systems that do not support extra CPUID information provided by the processor.

2.4.1.2 CPU TM function

This item specifies the Thermal Monitor Feature. If set to "Enabled" the BIOS enables the CPU's built in automatic thermal throttling when the die temperature is very near to the temperature limits of the processor. If set to "Disabled" the BIOS disables this feature and the MIC-3392 will shut off automatically if the CPU overheats. The default setting is "Enabled".

2.4.2 LAN & SMBus Configuration

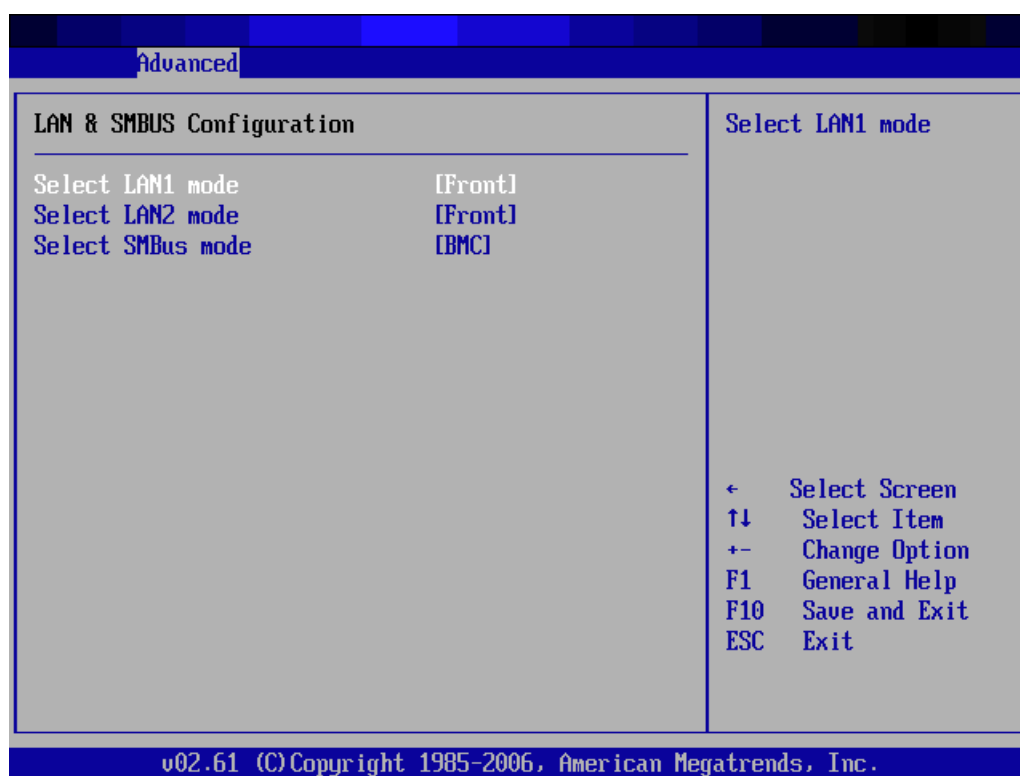

Figure 2.6 LAN & SMBus Configuration

2.4.2.1 Select LAN1/LAN2 mode

The item allows you to choose where the LAN1 and LAN2 Gigabit Ethernet ports are connected. There are 3 options: Front (Default), PICMG 2.16 and Rear I/O board.

2.4.2.2 Select SMBus mode

This setting indicates whether remote management is performed by Advantech's MIC-3924A Chassis Management Module (CMM) or by an IPMI-enabled CMM such as the Advantech MIC-3927. The default setting is "BMC" which corresponds to IPMI-enabled CMM.

Table 2.1: Select SMBus mode

	MIC-3924A
Default	BMC

2.4.3 IDE Configuration

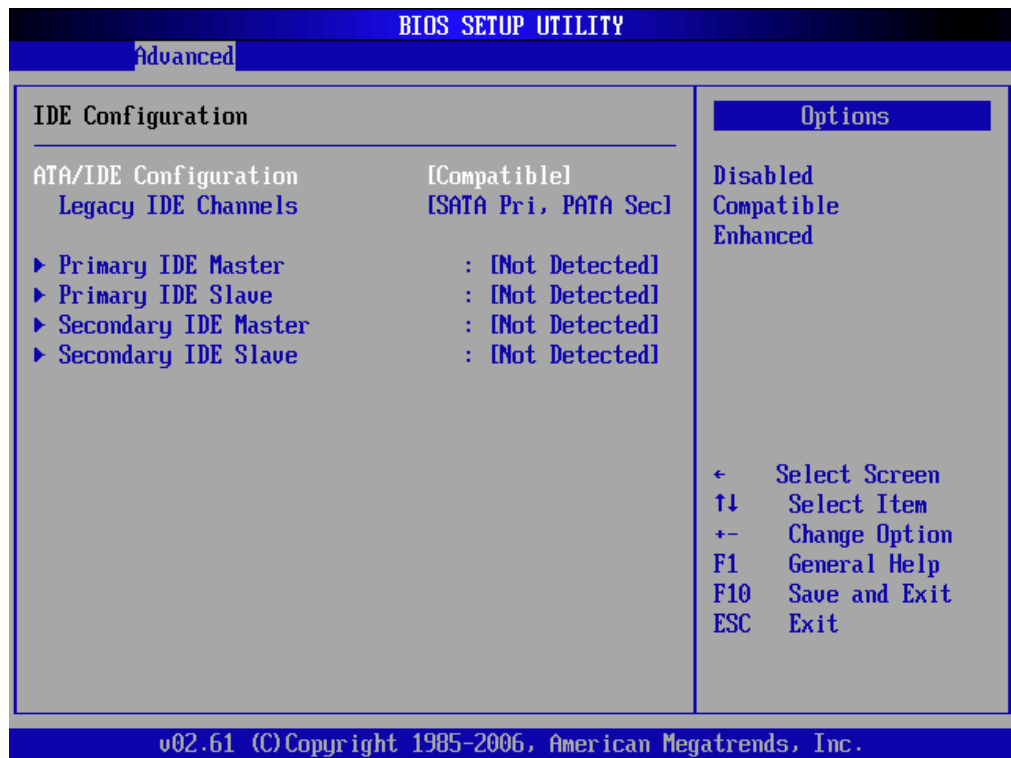

Figure 2.7 IDE Configuration

2.4.3.1 ATA/IDE Configuration

Three options are available: Disabled, Compatible or Enhanced. “Disabled” means that all IDE resources are disabled. “Compatible” enables up to 2 IDE channels for OS's requiring legacy IDE operation (default setting) and “Enhanced” enables all SATA and PATA resources.

2.4.3.2 Legacy IDE Channels

Four options are available: SATA Only, Reserved, “SATA Pri, PATA Sec” or PATA Only.

2.4.3.3 Primary and Secondary IDE Master and Slave

While entering setup, BIOS auto detects the presence of IDE devices. This displays the status of auto detection of the four possible IDE devices.

2.4.4 Floppy Configuration



Figure 2.8 Floppy Configuration

- **Floppy A:** Select the type of floppy drive connected to the system.
- **Floppy B:** Select the type of floppy drive connected to the system.

2.4.5 Super I/O Configuration

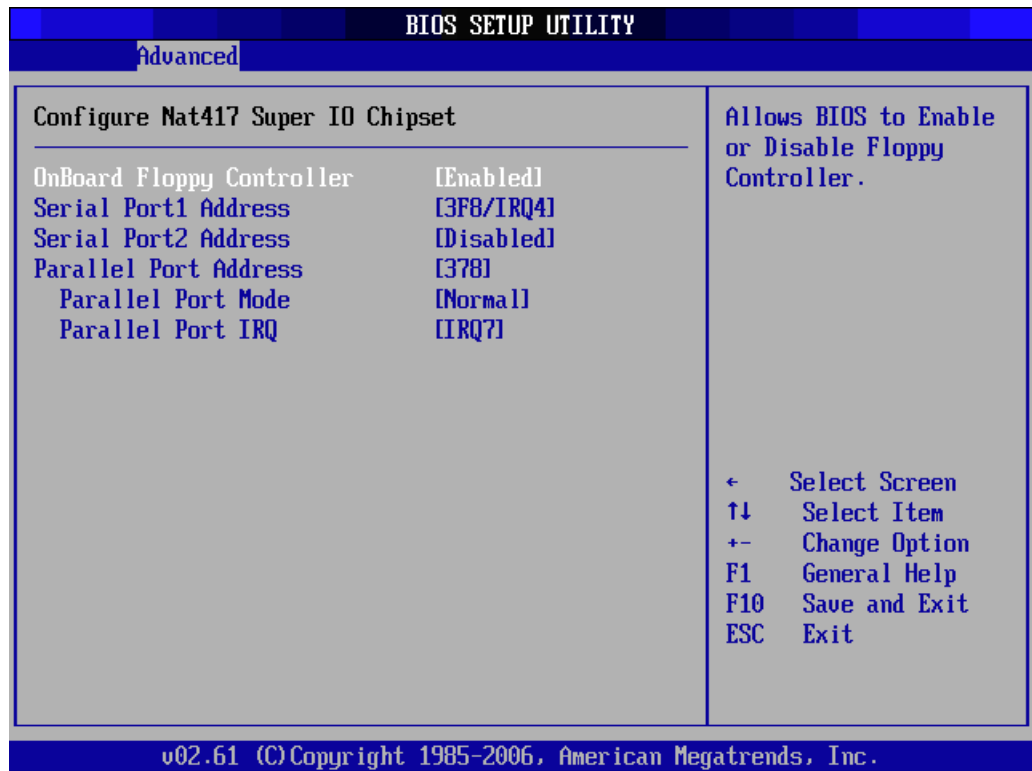

Figure 2.9 Super I/O Configuration

- **Onboard Floppy Controller:** Used to enable or disable the floppy controller
- **Serial Port1 Address:** Used to select Serial Port1 base addresses
- **Serial Port2 Address:** Used to select Serial Port2 base addresses
- **Parallel Port Address:** Used to select Parallel Port base addresses
 - **Parallel Port Mode:** Used to select Parallel Port mode
 - **Parallel Port IRQ:** Used to select Parallel Port IRQ

2.4.6 ACPI Setting

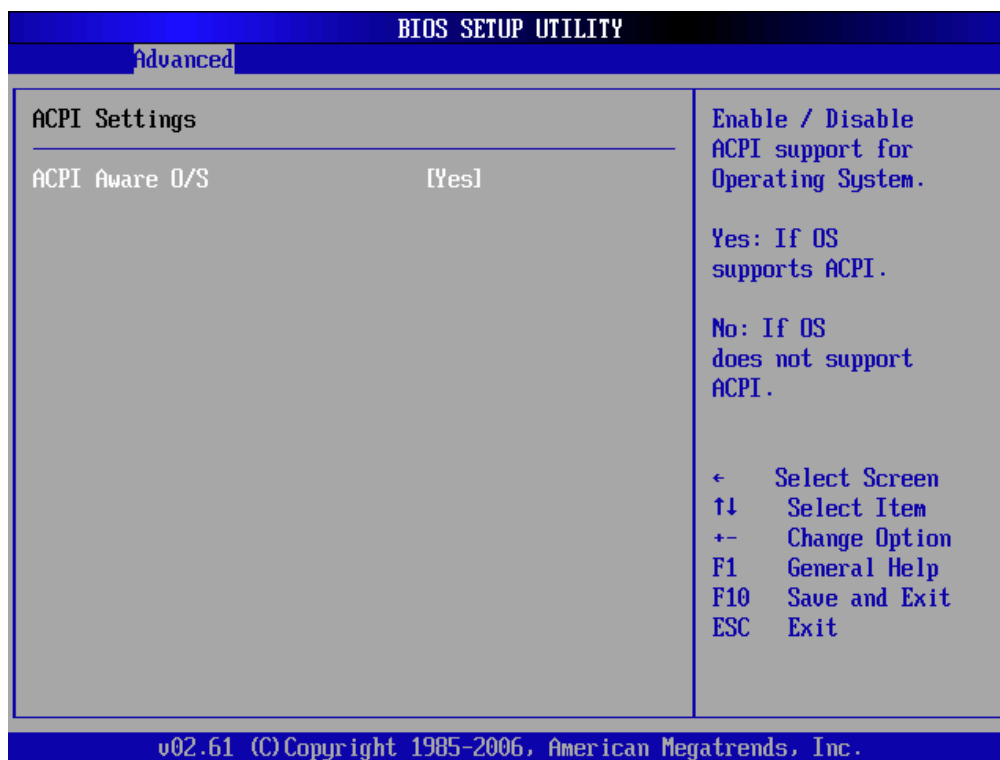

Figure 2.10 ACPI Setting

The options for “ACPI Aware O/S” are “Yes” or “No” in order to enable or disable ACPI support for the operating system. The default is “Yes”.

2.4.7 Hardware Health Configuration

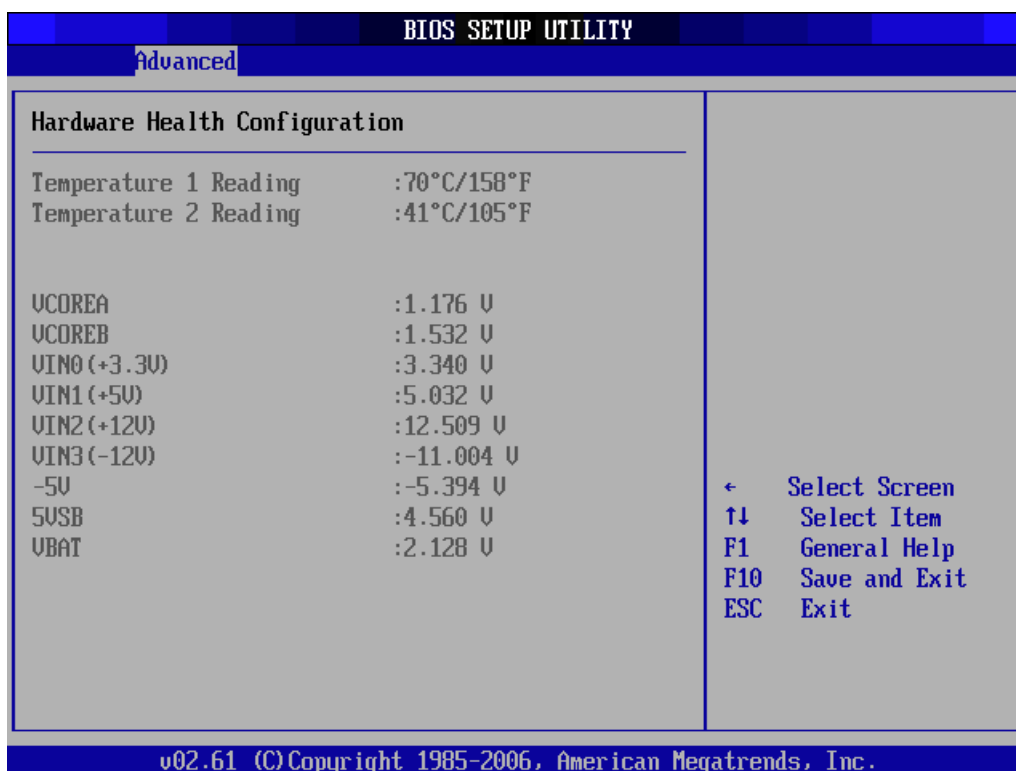

Figure 2.11 Hardware Health Configuration

2.4.8 Console Redirection Configuration

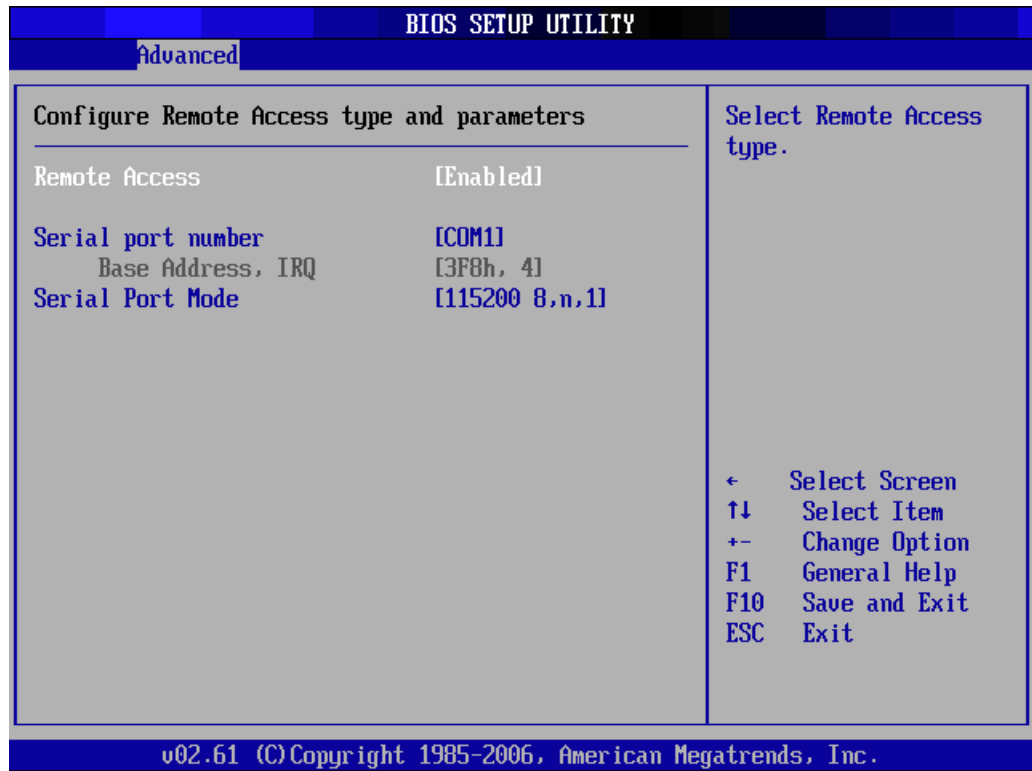

Figure 2.12 Configure Remote Access types and parameters

2.4.8.1 Remote Access

You can disable or enable the BIOS remote access feature here. The Optimal and Fail-Safe default setting is “Enabled”.

2.4.8.2 Serial Port Number

Select the serial port you want to use for console redirection. You can set the value for this option to either ICH COM1 or ICH COM2. The Optimal and Fail-Safe default setting is ICH COM1.

2.4.8.3 Serial Port Mode

Select the baud rate you want the serial port to use for console redirection. The Optimal and Fail-Safe default setting is 115200 8, n, 1.

2.5 PCI/PnP Setup

Select the PCI/PnP tab from the MIC-3392 setup screen to enter the Plug and Play BIOS Setup screen. You can display a Plug and Play BIOS Setup option by highlighting it using the <Arrow> keys. All Plug and Play BIOS Setup options are described in this section. The Plug and Play BIOS Setup screen is shown below.

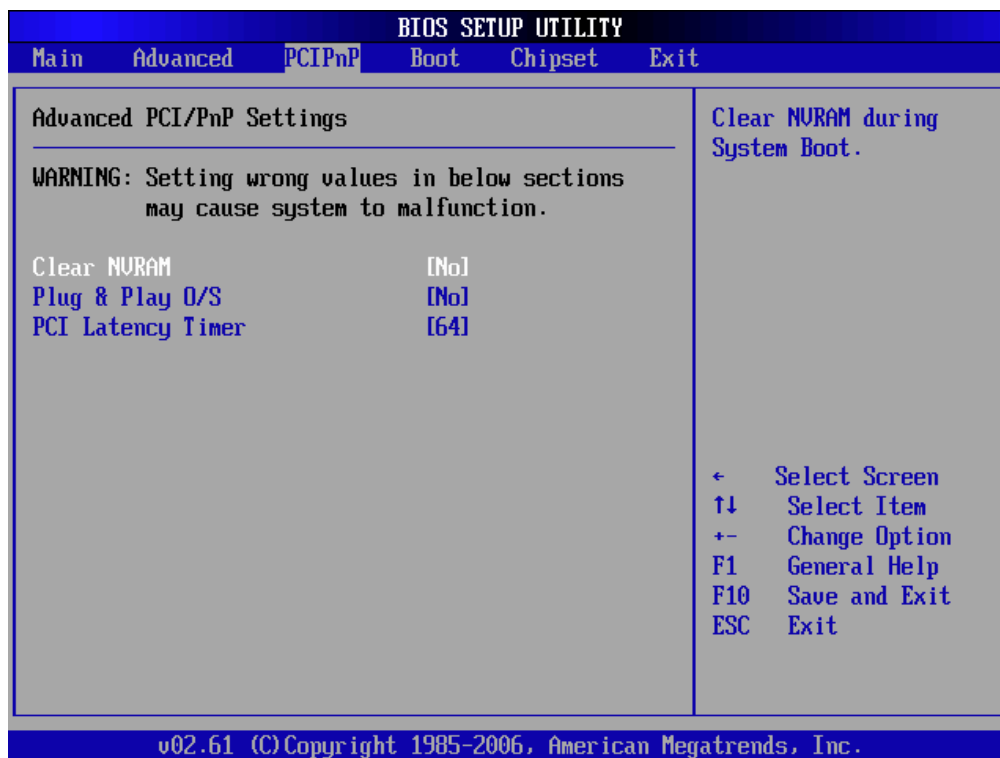

Figure 2.13 PCI/PnP Setup

2.5.1 Clear NVRAM

Set this value to force the BIOS to clear the Non-Volatile Random Access Memory (NVRAM). The Optimal and Fail-Safe default setting is No.

2.5.2 Plug and Play O/S

Set this value to allow the system to modify the settings for Plug and Play operating system support. The Optimal and Fail-Safe default setting is No.

2.5.3 PCI Latency Timer

This option sets the latency of all PCI devices on the PCI bus. The Optimal and Fail-Safe default setting is 64.

2.6 Boot Setup

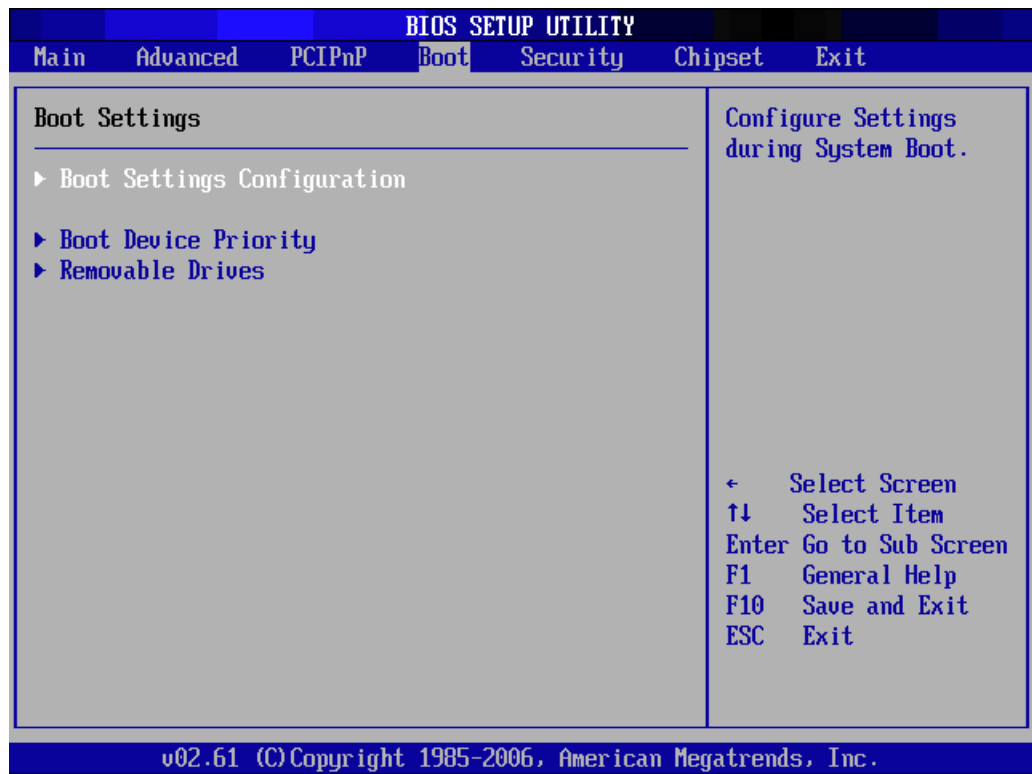

Figure 2.14 Boot Setup

2.6.1 Boot Settings Configuration

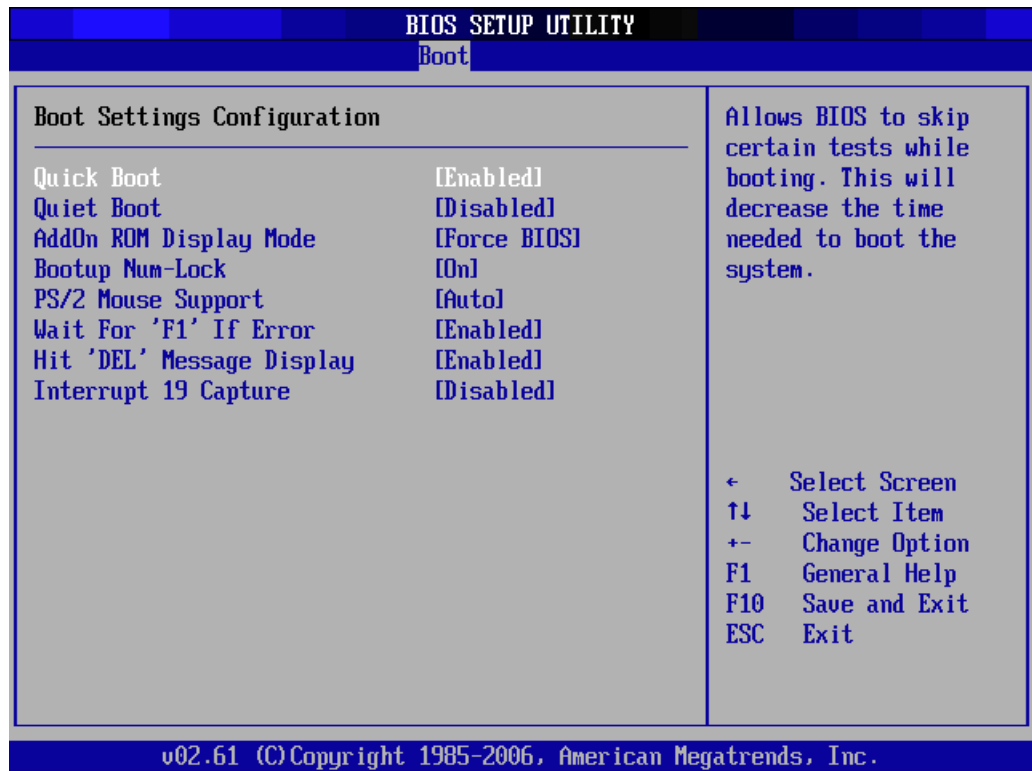

Figure 2.15 Boot Settings Configuration

- **Quick Boot:** Allows the BIOS to skip certain tests while booting. This will decrease the time needed to boot the system.
- **Wait For 'F1' If Error:** Wait for the F1 key to be pressed if an error occurs.
- **Hit 'DEL' Message Display:** Displays “Press DEL to run Setup” in POST.

2.7 Security Setup



Figure 2.16 Password Configuration

Select Security Setup from the MIC-3392 Setup main BIOS setup menu. All Security Setup options, such as password protection and virus protection, are described in this section. To access the sub menu for the following items, select the item and press <Enter>:

- Change Supervisor Password
- Change User Password
- Clear User Password

2.8 Advanced Chipset Settings

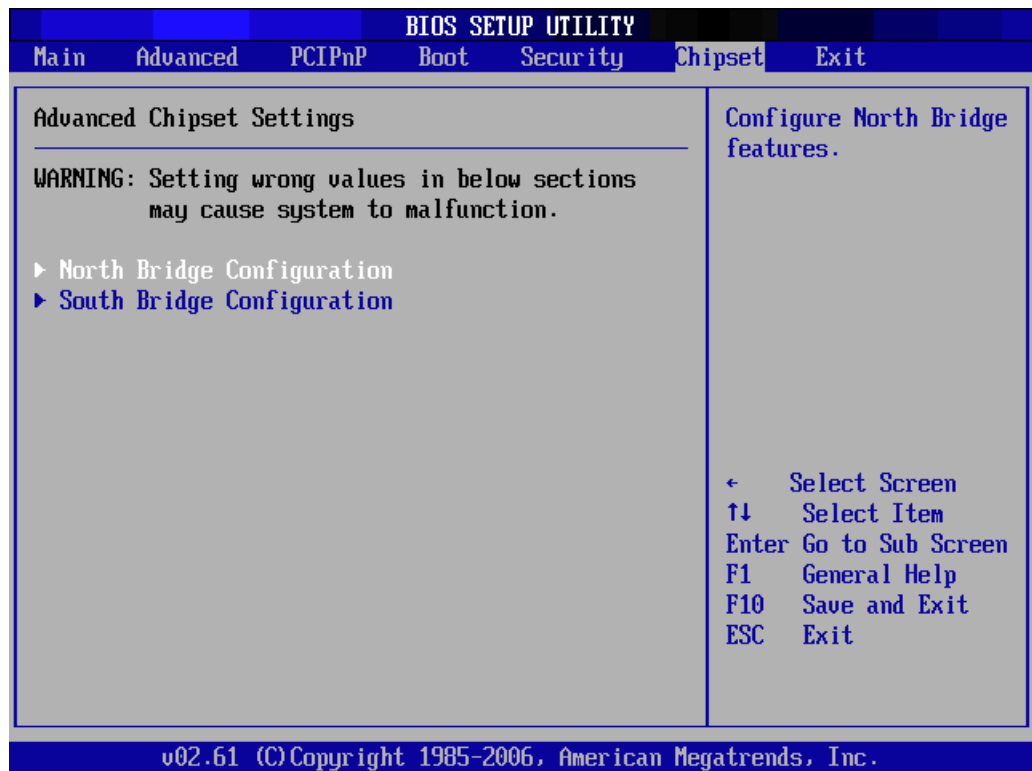

Figure 2.17 Advanced Chipset Setting

2.8.1 North Bridge Chipset Configuration

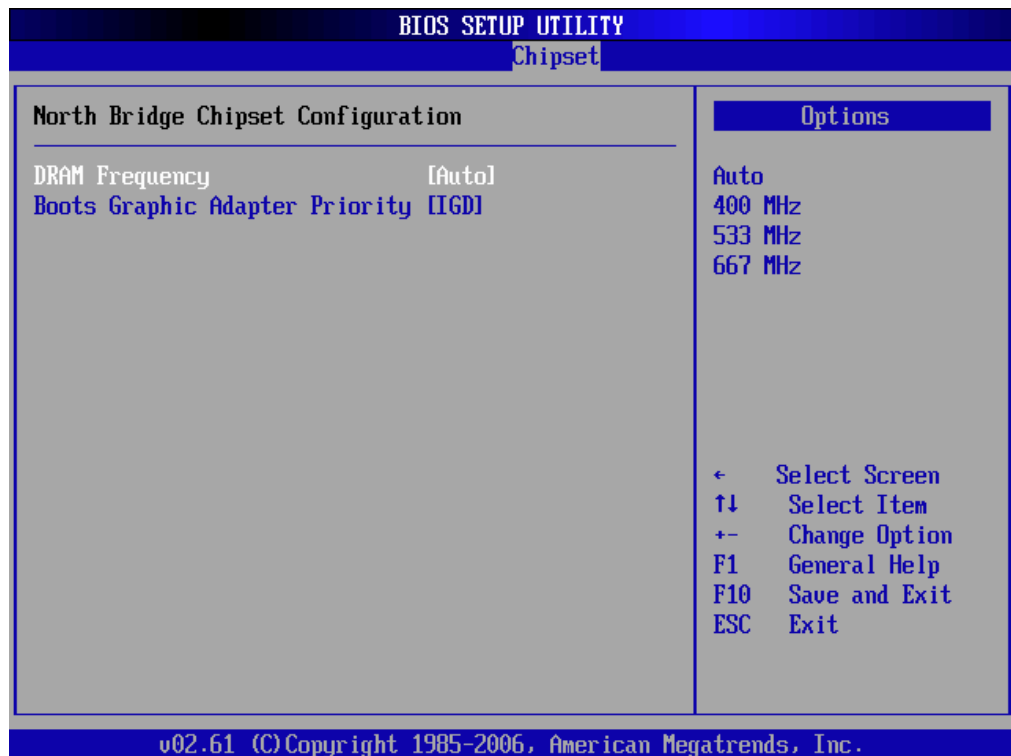

Figure 2.18 North Bridge Configuration

- **DRAM Frequency:** Auto, 533MHz, 667MHz
- **Boots Graphic Adapter Priority:** Select which graphics controller to use as the primary boot device.

2.8.2 South Bridge Configuration

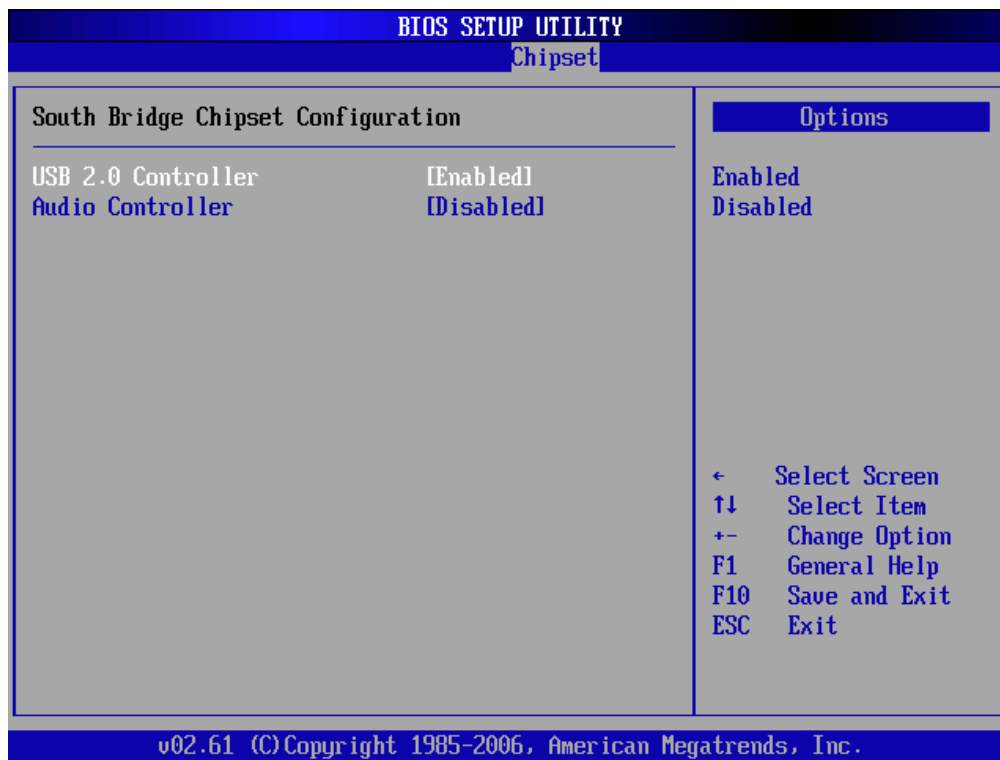

Figure 2.19 South Bridge Configuration

- **USB 2.0 Controller:** Enabled, Disabled
- **Audio Controller:** Auto, Azalia, AC'97 Audio and Modem, All Disabled

2.9 Exit Option



Figure 2.20 Exit Option

2.9.1 Save Changes and Exit

When you have completed the system configuration changes, follow these steps:

1. Select Exit Saving Changes from the Exit menu and press <Enter>. The following messages appear on the screen:
Save Configuration Changes and Exit Now?
[OK] [Cancel]
2. Select Ok to save changes and exit.

2.9.2 Discard Changes and Exit

Follow these steps to quit Setup without making any permanent changes to the system configuration.

1. Select Exit Discarding Changes from the Exit menu and press <Enter>. The following messages appear on the screen:
Discard Changes and Exit Setup Now?
[OK] [Cancel]
2. Select Ok to discard changes and exit. The following messages appear on the screen:
Discard Changes
3. Select Discard Changes from the Exit menu and press <Enter>.

2.9.3 Load Defaults

This loads the safe defaults values for the MIC-3392 which allows optimum functionality and system performance, but may not work best for all computer applications. Select Load Defaults from the Exit menu and press <Enter>.

Chapter 3

IPMI

This chapter describes IPMI configuration.

3.1 Introduction

The MIC-3392 fully supports the IPMI 2.0 interface and the PICMG 2.9 R1.0 specification. The Renesas H8S/2167 has been implemented as the IPMI controller / Baseboard Management Controller (BMC) to run firmware and collect information. The MIC-3392 IPMI firmware is sourced from Avocent, a provider of proven and tested IPMI implementations in a wide range of mission-critical applications. The BMC's key features and functions are listed below.

- Compliant with IPMI specification, revision 2.0
- Compliant with PICMG 2.9 specification
- Environment monitoring (temperature and voltage)
- Power/Reset control via IPMI chassis command
- Complete SEL, SDR and FRU functionality
- FRU data capacity: 2 KB
- Provides 4 messaging interfaces
 - One serial port
 - One LPC interface
 - One IPMB channel
 - One LAN channel messaging via sideband NIC for out-of-band management
- 4 I2C buses (including IPMB and SMBus) and 2 optional others
- Firmware Hub flashing and updating over serial port
- 1 hardware monitor
- 1 interrupt input
- Sensors threshold configuration
- Complete IPMI watchdog functionality (reset, power down, power cycle)
- Platform event filtering (PEF) and alert policies
- External Event Generation

3.2 Definitions

- **BMC - (Baseboard Management Controller):** This is the common abbreviation for an IPMI Baseboard Management Controller.
- **IPMB - (Intelligent Platform Management Bus):** A protocol defined for passing IPMI messages over a public I2C bus.
- **IPMI - (Intelligent Platform Management Interface):** A standardized system management interface. Please refer to the IPMI Specification for more details.
- **IPMIv2.0:** Specifically version 2.0 of IPMI

3.3 IPMI function list

The following standard IPMI commands are supported.

Note!



The Network function (NetFn) field identifies the functional class of the message. The Network Function clusters IPMI commands into different sets. Please refer to the IPMI specification of network function codes for more information.

These command codes are compliant with the IPMI specification. Mandatory and Optional commands are defined in the IPMI specification. For more details, please refer to the IPMI specification.

3.3.1 IPMI Device Global Commands

Table 3.1: Supported IPMI commands

IPMI Device Global Commands	NetFn	Cmd	Mandatory / Optional
Get Device Id	App	0x01	M
Cold Reset	App	0x02	O
Get Self Test Results	App	0x04	M
Manufacturing Test On	App	0x05	O
Set ACPI Power State	App	0x06	O
Get ACPI Power State	App	0x07	O
Get Device GUID	App	0x08	O

3.3.2 BMC Device and Messaging Interfaces

The BMC messaging interfaces comply with the Intelligent Platform Management Interface Specification, Version 2.0. The MIC-3392 provides 4 messaging interface channels.

- **LPC/KCS channel:** Connects the H8S/2167 to the system LPC bus. Firmware sets 1 host interface over LPC:KCS for SMS.
- **IPMB channel:** Connects IPMB devices or connects to the H8S/2167's I2C_0 interface.
- **Serial port:** The H8S/2167 supports one serial port for out-of-band management (OOB) as well as one serial port for firmware flash update. Serial Port 0 is selected for OOB serial port
- **LAN channel:** OOB management over LAN is accomplished by a sharing a NIC (LAN2 or LAN3). This messaging interface channel connects the H8S/2167's I2C interface to the NIC's SMBus interface.

Table 3.2: H8S12C bus connection to NIC SMBus

	H8S/2167 Pin Name	I2C address	Pin Number	System Connection
I2C_1	SCL1	0xC6	48	NIC SMBus clock
	SDA1		47	NIC SMBus data

Table 3.3: NIC Interrupt

H8S/2167 Pin Name	Pin Number	Usage
IRQ1#	130	SMALERT# for NIC SMBus

Table 3.4: BMC Device and Messaging Commands

BMC Device and Messaging Commands	NetFn	Cmd	Mandatory / Optional
Set BMC Global Enables	App	0x2e	M
Get BMC Global Enables	App	0x2f	M
Clear Message Flags	App	0x30	M
Get Message Flags	App	0x31	M
Enable Message Channel Receive	App	0x32	O
Get Message	App	0x33	M
Send Message	App	0x34	M
Read Event Message Buffer	App	0x35	O
Get System GUID	App	0x37	O
Get Channel Authentication Capabilities	App	0x38	O
Get Session Challenge	App	0x39	O
Activate Session	App	0x3a	O
Set Session Privilege Level	App	0x3b	O
Close Session	App	0x3c	O
Get Session Information	App	0x3d	O
Get AuthCode	App	0x3f	O
Set Channel Access	App	0x40	O
Get Channel Access	App	0x41	O
Get Channel Info	App	0x42	O
Set User Access	App	0x43	O
Get User Access	App	0x44	O
Set User Name	App	0x45	O
Get User Name	App	0x46	O
Set User Password	App	0x47	O
Master Write-Read	App	0x52	M

3.3.3 BMC Watchdog Timer Commands

Table 3.5: BMC Watchdog Timer Commands

BMC Watchdog Timer Commands	NetFn	Cmd	Mandatory / Optional
Reset Watchdog Timer	App	0x22	M
Set Watchdog Timer	App	0x24	M
Get Watchdog Timer	App	0x25	M

3.3.4 Chassis Device Commands

Table 3.6: Chassis Device commands

Chassis Device Commands	NetFn	Cmd	Mandatory / Optional
Get Chassis Capabilities	Chassis	0x00	M
Get Chassis Status	Chassis	0x01	M
Chassis Control	Chassis	0x02	M
Chassis Identify	Chassis	0x04	O
Set Chassis Capabilities	Chassis	0x05	O
Get System Restart Cause	Chassis	0x07	O
Set System Boot Options	Chassis	0x08	O
Get System Boot Options	Chassis	0x09	O
Set Front Panel Button Enables	Chassis	0x0a	O
Set Power Cycle Interval	Chassis	0x0b	O

3.3.5 Event Commands

Table 3.7: Event commands

Event Commands	NetFn	Cmd	Mandatory / Optional
Set Event Receiver	S/E	0x00	M
Get Event Receiver	S/E	0x01	M
Platform Event	S/E	0x02	M

3.3.6 PEF and Alerting Commands

Table 3.8: PEF and Alerting commands

PEF and Alerting Commands	NetFn	Cmd	Mandatory / Optional
Get PEF Capabilities	S/E	0x10	M
Arm PEF Postpone Timer	S/E	0x11	M
Set PEF Configuration Parameters	S/E	0x12	M
Get PEF Configuration Parameters	S/E	0x13	M
Set Last Processed Event ID	S/E	0x14	M
Get Last Processed Event ID	S/E	0x15	M
Alert Immediate	S/E	0x16	O
PET acknowledge	S/E	0x17	O

3.3.7 SEL Device Commands

Table 3.9: SEL Device commands

SEL Device Commands	NetFn	Cmd	Mandatory / Optional
Get SEL Info	Storage	0x40	M
Reserve SEL	Storage	0x42	O
Get SEL Entry	Storage	0x43	M
Add SEL Entry	Storage	0x44	M
Clear SEL	Storage	0x47	M
Get SEL Time	Storage	0x48	M
Set SEL Time	Storage	0x49	M

3.3.8 SDR Device Commands

Table 3.10: SDR Device commands

SDR Device Commands	NetFn	Cmd	Mandatory / Optional
Get SDR Repository Info	Storage	0x20	M
Reserve SDR Repository	Storage	0x22	M
Get SDR	Storage	0x23	M
Get SDR Repository Time	Storage	0x28	M
Set SDR Repository Time	Storage	0x29	M
Run Initialization Agent	Storage	0x2c	O

3.3.9 FRU data

The MIC-3392 supports the IPMI FRU function to store accessible multiple sets of non-volatile Field Replaceable Unit (FRU) information in FRU EEPROM. The FRU data includes information such as serial number, part number, model and asset tag. FRU information is accessed using IPMI commands compliant to the IPMI 2.0 specification as below.

Table 3.11: FRU Device commands

FRU Device Commands	NetFn	Cmd	Mandatory / Optional
Get FRU Inventory Area Info	Storage	0x10	M
Read FRU Inventory Data	Storage	0x11	M
Write FRU Inventory Data	Storage	0x12	M

3.3.10 Sensors and Threshold configuration

Sensor data record (SDR) repository will be stored in BMC's flash memory and cannot be changed.

- Note!** *UNC = Upper Non-Critical.*
 *UC = Upper Critical*
UNR = Upper Non-Recoverable
LNC = Lower Non-Critical
LC = Lower Critical
LNR = Lower Non-Recoverable

Table 3.12: Sensor List

Sensor Name	Sensor Number	Sensor Type	Reading Type Sensor	Logged Assertions	Logged De-assertions
Power Unit Status	50h	09h	6Fh	00h - Power Off 04h - AC Lost	00h - Power Off
Watchdog	51h	23h	6Fh	00h - Timer Expired, status only 01h - Hard Reset 02h - Power Down 03h - Power Cycle	N/A
Power Failure	52h	C0h	6Fh	00h - Power Failure 07h - over 75% full	00h - Power Failure
SEL Full	64h	D0h	01h	09h - over 90% full 0Bh - 100% full	N/A
W83782D Temp	00h	01	01h	UNC, UNR	UNC, UNR
W83782D 3.3V	01h	02h	01h	LC, UC	LC, UC
W83782D 2.5V	02h	02h	01h	LC, UC	LC, UC
W83782D 5V	03h	02h	01h	LC, UC	LC, UC
W83782D 12V	04h	02h	01h	LC, UC	LC, UC
W83782D VCC	05h	02h	01h	LNC,UC	LNC,UC

- Note!** *A chassis intruder sensor is not used on the MIC-3392 platform.*
 *Power failure sensor type "C0h" indicates a power failure event.*
Apart from the following list of sensors, other sensors should be reinitialized when the system is powered on or reset.
- VCC
 - SEL Fullness
 - System PWR monitor
 - Watchdog

Table 3.13: Threshold values of sensors

Sensor Number	01h	02h	03h	04h	05h	00h
Entity Instance	01h	01h	01h	01h	01h	01h
Nominal Reading	3.3 V	2.5 V	5 V	12 V	1.5 V	35° C
UNR	N/A	N/A	N/A	N/A	N/A	55° C
UC	3.62 V	2.76 V	5.6 V	13.4 V	1.65 V	N/A
UNC	N/A	N/A	N/A	N/A	N/A	45° C
LNR	N/A	N/A	N/A	N/A	N/A	N/A
LC	2.96 V	2.24 V	4.4 V	10.6 V	1.2 V	N/A
LNC	N/A	N/A	N/A	N/A	N/A	N/A
Positive-going	0x02	0x02	0x02	0x02	0x02	
Negative-going	0x02	0x02	0x02	0x02	0x02	

Table 3.14: Sensor Device Commands

Sensor Device Commands	NetFn	Cmd	Mandatory / Optional
Set Sensor Hysteresis	S/E	0x24	O
Get Sensor Hysteresis	S/E	0x25	O
Set Sensor Threshold	S/E	0x26	O
Get Sensor Threshold	S/E	0x27	O
Set Sensor Event Enable	S/E	0x28	O
Get Sensor Event Enable	S/E	0x29	O
Re-arm Sensor Events	S/E	0x2a	O
Get Sensor Event Status	S/E	0x2b	O
Get Sensor Reading	S/E	0x2d	M

3.3.11 Serial over LAN

The MIC-3392 supports Serial over LAN (SOL). This can be used for implementing a virtual remote serial terminal to enable user or remote software interaction with serial interfaces for operating system and management services. SOL is implemented as a payload type under the IPMI v2.0 “RMCP”+ protocol.

Table 3.15: LAN Device Commands

LAN Device Commands	NetFn	Cmd	Mandatory / Optional
Set LAN Configuration Parameters	Transport	0x01	M
Get LAN Configuration Parameters	Transport	0x02	M

3.3.12 Serial/Modem Device Commands

Table 3.16: Serial/Modem Device Commands

Serial/Modem Device Commands	NetFn	Cmd	Mandatory / Optional
Set Serial/Modem Configuration Parameters	Transport	0x10	M
Get Serial/Modem Configuration Parameters	Transport	0x11	M
Set Serial/Modem Mux	Transport	0x12	M

3.4 BMC Reset

The BMC can initiate a graceful shutdown of the MIC-3392 by issuing a short pulse (~500 ms) on the power button signal to the ACPI controller when commanded through its host, OOB, or IPMB channels as well as from a Graceful Shutdown Event from the CMM or a Handle OPEN event. An ACPI compliant OS will then perform a graceful shutdown and light the blue LED whereas a non-compliant OS will just shut down.

Note!  *The Network function (NetFn) field identifies the functional class of the message. The Network Function clusters IPMI commands into different sets. Please refer to the IPMI specification of network function codes for more information.*

These command codes are compliant with the IPMI specification.

Mandatory and Optional commands are defined in the IPMI specification. For more details, please refer to the IPMI specification.

Appendix **A**

Pin Assignments

This appendix describes pin assignments.

A.1 J1 Connector

Table A.1: J1 CompactPCI I/O

	Row A	Row B	Row C	Row D	Row E	Row F
1	+5V	-12V	TRST# (NC)	+12V	+5V	GND
2	TCK (NC)	+5V	TMS (NC)	TDO	TDI (NC)	GND
3	INTA#	INTB#	INTC#	+5V	INTD#	GND
4	IPMB_PWR	HEALTHY#	V(I/O)	INTP	INTS	GND
5	NC	NC	PCI_RST#	GND	GNT0#	GND
6	REQ0#	PCI_PRESENT	+3.3V	CLK0	AD31	GND
7	AD30	AD29	AD28	GND	AD27	GND
8	AD26	GND	V(I/O)	AD25	AD24	GND
9	C/BE3#	IDSEL	AD23	GND	AD22	GND
10	AD21	GND	+3.3V	AD20	AD19	GND
11	AD18	AD17	AD16	GND	C/BE2#	GND
12						-
13			Key Area			GND
14						-
15	+3.3V	FRAME#	IRDY#	BD_SEL#	TRDY#	GND
16	DEVSEL#	PCIXCAP	V(I/O)	STOP#	LOCK#	GND
17	+3.3V	IPMB_SCL	IPMB_SDA	GND	PERR#	GND
18	SERR#	GND	+3.3V	PAR	C/BE1#	GND
19	+3.3V	AD15	AD14	GND	AD13	GND
20	AD12	GND	V(I/O)	AD11	AD10	GND
21	+3.3V	AD9	AD8	M66EN	C/BE0#	GND
22	AD7	GND	+3.3V	AD6	AD5	GND
23	+3.3V	AD4	AD3	+5V	AD2	GND
24	AD1	+5V	V(I/O)	AD0	ACK64#	GND
25	+5V	REQ64#	ENUM#	+3.3V	+5V	GND

Note! NC: No Connect



#: Active Low

A.2 J2 Connector

Table A.2: J2 CompactPCI I/O

	Row A	Row B	Row C	Row D	Row E	Row F
1	CLK1	GND	REQ1#	GNT1#	REQ2#	GND
2	CLK2	CLK3	SYSEN#	GNT2#	REQ3#	GND
3	CLK4	GND	GNT3#	REQ4#	GNT4#	GND
4	V(I/O)	NC	C/BE7#	GND	C/BE6#	GND
5	C/BE5#	GND	V(I/O)	C/BE4#	PAR64	GND
6	AD63	AD62	AD61	GND	AD60	GND
7	AD59	GND	V(I/O)	AD58	AD57	GND
8	AD56	AD55	AD54	GND	AD53	GND
9	AD52	GND	V(I/O)	AD51	AD50	GND
10	AD49	AD48	AD47	GND	AD46	GND
11	AD45	GND	V(I/O)	AD44	AD43	GND
12	AD42	AD41	AD40	GND	AD39	GND
13	AD38	GND	V(I/O)	AD37	AD36	GND
14	AD35	AD34	AD33	GND	AD32	GND
15	NC	GND	FAL# (NC)	REQ5#	GNT5#	GND
16	NC	NC	DEG# (NC)	GND	NC	GND
17	NC	GND	PRST#	REQ6#	GNT6#	GND
18	NC	NC	NC	GND	NC	GND
19	NC	GND	SMB-SDA	SMB-SLL	SMB-ALERT#	GND
20	CLK5	NC	NC	GND	NC	GND
21	CLK6	GND	NC	NC	NC	GND
22	GA4	GA3	GA2	GA1	GA0	GND

Note! NC: No Connect
#: Active Low



A.3 J3 Connector

Table A.3: J3 CompactPCI I/O (LPT, FDD, Parallel IDE, 2.16)

Row A	Row B	Row C	Row D	Row E	Row F
1 LPT_PD0	LPT_PD1	LPT_PD2	LPT_PD3	LPT_PD4	GND
2 LPT_PD5	LPT_PD6	LPT_PD7	LPT_BUSY	FDD_DRVEN1	GND
3 LPT_STB#	LPT_AFD#	FDD_DRVEN0	FDD_INDEX#	FDD_DSKCHG#	GND
4 LPT_ERR#	LPT_ACK#	FDD_RDATA#	FDD_WP#	FDD_TRACK0#	GND
5 LPT_PE	LPT_SLCT	FDD_STEP#	FDD_MTR0#	FDD_WD#	GND
6 LPT_SLIN#	LPT_INIT#	FDD_WE#	FDD_HEAD#	FDD_DSA#	GND
7 FDD_DIR#	PATA_ACK#	PATA_RST#	PDIORDY	PATA_CS#1	GND
8 IRQ15	PATA_DETECT	PATA_DA0	PATA_DA1	PATA_DA2	GND
9 CF_LED#	RIO_CLOCK	PATA_IOW#	PATA_REQ	PATA_CS#3	GND
10 PATA_D15	PATA_D14	PATA_IOR#	PATA_D10	PATA_D11	GND
11 PATA_D5	PATA_D9	PATA_D13	PATA_D6	PATA_D8	GND
12 PATA_D1	PATA_D3	PATA_D12	PATA_D4	PATA_D7	GND
13 PATA_D0	PATA_D2	NC	NC	NC	GND
14 SATA_RX0N	SATA_RX0P	NC	SATA_TX0N	SATA_TX0P	GND
15 2.16_B1+	2.16_B1-	GND	2.16_B3+	2.16_B3-	GND
16 2.16_B0+	2.16_B0-	GND	2.16_B2+	2.16_B2-	GND
17 2.16_A1+	2.16_A1-	GND	2.16_A3+	2.16_A3-	GND
18 2.16_A0+	2.16_A0-	GND	2.16_A2+	2.16_A2-	GND
19 NC	NC	NC	NC	NC	GND

Note! NC: No Connect



#: Active Low

A.4 J5 Connector

Table A.4: J5 CompactPCI I/O (VGA, LAN, COM, USB, PS/2)

	Row A	Row B	Row C	Row D	Row E	Row F
1	GbE1_MD0+	GbE1_MD0-	GND	GbE1_MD1+	GbE1_MD1-	GND
2	GbE1_MD2+	GbE1_MD2-	GND	GbE1_MD3+	GbE1_MD3-	GND
3	GbE2_MD0+	GbE2_MD0-	GND	GbE2_MD1+	GbE2_MD1-	GND
4	GbE2_MD2+	GbE2_MD2-	GND	GbE2_MD3+	GbE2_MD3-	GND
5	GND	GND	+3.3V	GND	GND	GND
6	GbE1_100#	GbE1_LNK#	GbE2_1000#	GbE2_LNK#	+5V	GND
7	GbE1_1000#	NC	GbE2_100#	NC	+5V	GND
8	NC	NC	COM2_TX	COM2_RTS	PS2_KBDAT	GND
9	NC	COM2_RX	COM2_DTR	COM2_CTS	PS2_KBCLK	GND
10	COM2_DCD	NC	COM2_RI	COM2_DSR	PS2_MS DAT	GND
11	COM1_RX	COM1_CTS	NC	NC	PS2_MSCLK	GND
12	COM1_TX	COM1_DSR	NC	LAN3-ACT#	VGA_DAT	GND
13	COM1_RTS	COM1_DTR	NC	LAN3-LNK#	VGA_CLK	GND
14	COM1_DCD	COM1_RI	RIO-LED#	LAN3-SPD#	GND	GND
15	USB_OC3#	RIO Install	RIO-HW-SW	GND	VGA_BLUE	GND
16	USB_OC2#	GNT7	GND	VGA_VSYNC	GND	GND
17	GND	REQ7	NC	GND	VGA_GREEN	GND
18	USB_P2+	GND	GND	VGA_HSYNC	GND	GND
19	USB_P2-	GND	USB_P3+	GND	VGA_RED	GND
20	GND	GND	USB_P3-	GND	GND	GND
21	SATA_RX2N	SATA_RX2P	GND	SATA_TX2N	SATA_TX2P	GND
22	LAN3_RD+	LAN3_RD-	GND	LAN3_TD+	LAN3_TD-	GND

Note! NC: No Connect



#: Active Low

A.5 Other Connectors

Table A.5: VCN1 VGA Connector

1	RED	9	+5V
2	GREEN	10	GND
3	BLUE	11	NC
4	NC	12	DDC_DATA
5	GND	13	HSYNC
6	GND	14	VSYNC
7	GND	15	DDC_CLK
8	GND		

Table A.6: CN9 COM1 (RJ45) Connector

1	DCD#	6	DSR#
2	SIN	7	RTS#
3	SOUT	8	CTS#
4	DTR#		
5	GND		

Table A.7: CN4 & CN5 USB port 1 & port 2

1	+5V (fused)	1	+5V (fused)
2	USBD0-	2	USBD1-
3	USBD0+	3	USBD1+
4	GND	4	GND

Table A.8: BT1 CMOS battery

1	BAT_VCC	2	GND
---	---------	---	-----

Table A.9: CN10 CF socket

1	GND	2	D3
3	D4	4	D5
5	D6	6	D7
7	CS1#	8	GND
9	GND	10	GND
11	GND	12	GND
13	+5V (?)	14	GND
15	GND	16	GND
17	GND	18	A2
19	A1	20	A0
21	D0	22	D1
23	D2	24	NC
25	GND	26	GND
27	D11	28	D12
29	D13	30	D14
31	D15	32	CS3#
33	NC	34	IORD#
35	IOWR#	36	WE#
37	IRQ14	38	+5V (?)
39	CSEL#	40	NC
41	RESET#	42	IORDY#
43	REQ#	44	REG#
45	DASP#	46	DET#
47	D8	48	D9
49	D10	50	GND

Table A.10: CN4 SATA daughter board connector

1	GND	2	GND
3	GND	4	SATA_TX0P
5	GND	6	SATA_TX0N
7	GND	8	GND
9	GND	10	SATA_RX0N
11	GND	12	SATA_RX0P
13	GND	14	GND
15	RSV (+3.3V/+12V)	16	+5V
17	RSV (+3.3V/+12V)	18	+5V
19	RSV (+3.3V/+12V)	20	+5V

Table A.11: RJ1 LAN1 Connector

1	LANMDI_0+	5	LANMDI_2-
2	LANMDI_0-	6	LANMDI_1-
3	LANMDI_1+	7	LANMDI_3+
4	LANMDI_2+	8	LANMDI_3-

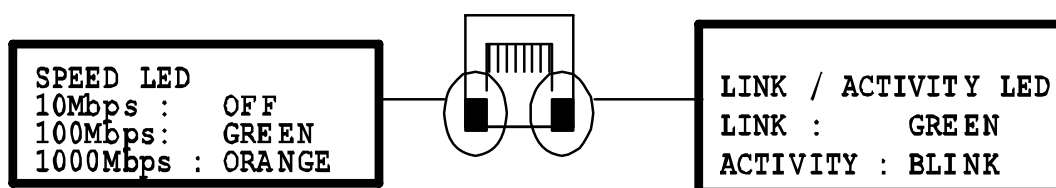
Table A.12: RJ1 LAN1 Indicator

A.5.1 M/D, PWR & IDE/Hot-swap LEDs

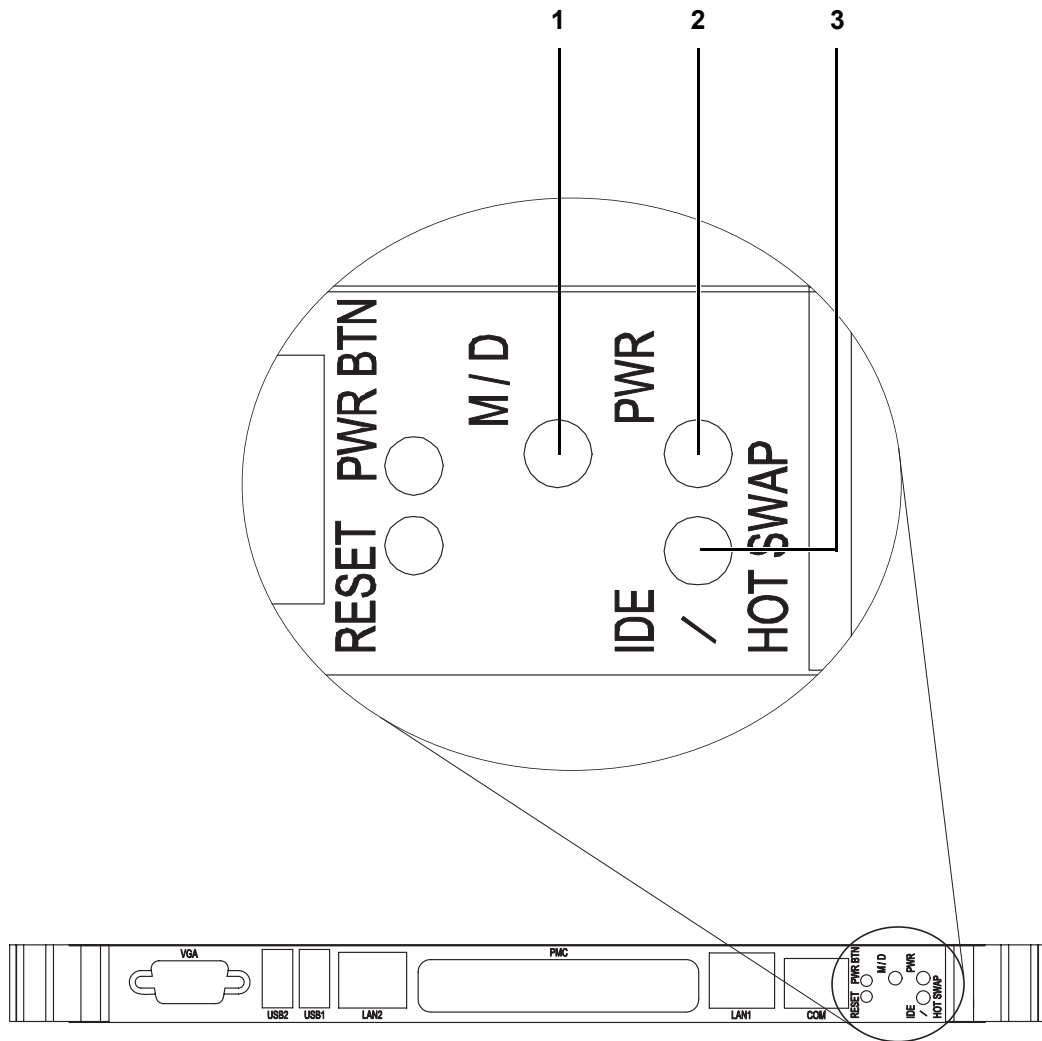

Name	Description
1 M/D (Green)	Indicates Master or Drone mode status
2 PWR (Green)	Indicates the power status
3 IDE / Hot-swap (Yellow/Blue)	Indicates IDE activity when yellow, or that the board is ready to be hot-swapped when blue.

Appendix **B**

Programming the Watchdog Timer

This appendix describes how to program the watchdog timer.

B.1 Watchdog Timer Programming Procedure

To program the watchdog timer, you must execute a program that writes a value to I/O port address 443/444 (hex) for Enable/Disable. This output value represents time interval. The value range is from 01 (hex) to FF (hex), and the related time interval is 1 to 255 seconds.

Data	Time Interval
01	1 sec.
02	2 sec.
03	3 sec.
04	4 sec.
...	...
3F	63 sec.

After data entry, your program must refresh the watchdog timer by rewriting the I/O port 443 and 043 (hex) while simultaneously setting it. When you want to disable the watchdog timer, your program should read I/O port 043 (hex). The following example shows how you might program the watchdog timer in BASIC:

```
10 REM Watchdog timer example program
20 OUT &H443, data REM Start and restart the watchdog
30 GOSUB 1000 REM Your application task #1,
40 OUT &H443, data REM Reset the timer
50 GOSUB 2000 REM Your application task #2,
60 OUT &H443, data REM Reset the timer
70 X=INP (&H444) REM, Disable the watchdog timer
80 END
1000 REM Subroutine #1, your application task
...
1070 RETURN
2000 REM Subroutine #2, your application task
...
2090 RETURN.
```

Appendix **C**

CPLD

This appendix describes CPLD configuration.

C.1 Features

- **Drone Mode**
- **Hot-Swap:** Hot insertion and removal control
- **CompactPCI Backplane:** CompactPCI slot Addressing
- **LPC Bus:** Provide LPC Bus access
- **Watchdog**
- **Debug Message:** Boot time POST message

C.2 CPLD I/O Registers

The Advantech MIC-3392 CPLD communicates with four main I/O spaces. The LPC (low pin count) Unit is used to interconnect the Intel ICH7M LPC signals. The Debug Port Unit is used to decode POST codes. The Hot-Swap Out-Of-Service LED Control Unit is used to control the blue LED during Hot-Insert and Hot-Remove. The Drone Mode Unit is used to disable the cPCI bridge. The other signals in the Miscellaneous Unit are for interfacing with corresponding I/O interface signals.

Table C.1: LPC I/O registers address

LPC Address	I/O Type	Description
0x 80h	R	Debug Message
0x 443h	W	Watchdog Register (enable)
0x 444h	R	Watchdog Register (disable)
0x 445h	R	CPLD version
0x 447h	R	Geography Address (GA)

C.2.1 Debug Message

Table C.2: Debug_Code [7:0] (LPC I/O address: 80H)

Bits	Name	Default State	Valid State	Read Only Function
7 ~ 0	Debug code	xxh	0 ~ FFh	Show debug code from Port 80h. Bit 7 (MSB) ... 0 (LSB) is mapped to LED7...0

C.2.2 Watchdog Register

Table C.3: Watchdog [7:0] (LPC I/O address: 443H)

Bits	Name	Default State	Valid State	Write Only Function
7 ~ 0	Watchdog	xxh	1 ~ FFh	Any non-zero value in I/O port 443h enables the watchdog function. The watchdog reset time is 1 ~ 255 seconds (1 second per step).

C.2.3 Watchdog Disable Register

Table C.4: Watchdog [7:0] (LPC I/O address: 444H)

Bits	Name	Default State	Valid State	Read Only Function
7 ~ 0	Watchdog	xxh	xxh	Reading I/O port 444h will disable the watchdog. The return value is meaningless.

Table C.5: Version [7:0] (LPC I/O address: 445H)

Bits	Name	Default State	Valid State	Read Only Function
7 ~ 4	CPLD Version (units)	xxh	xxh	Read I/O port 444h to get the CPLD version in BCD. E.g, for v1.4, the return value is: Bit 7 6 5 4 0 0 0 1
3 ~ 0	CPLD Version (tenths)	xxh	xxh	Read I/O port 444h to get the CPLD version in BCD. E.g, for v1.4, the return value is: Bit 4 3 2 1 0 1 0 0

C.2.4 Geography Address (GA)

This read-only address shows the CPCI backplane slot position.

Table C.6: GA [7:0] (LPC I/O address: 447H)

Bits	Name	Default State	Valid State	Read Only Function
7 ~ 5	Reserved	X	X	Bit 7 ... Bit 5 are always 111.
4	GA4 (MSB)	X	0/1	Bit 4 is connected to the J2.A22 pin.
3	GA3	X	0/1	Bit 3 is connected to the J2.B22 pin.
2	GA2	X	0/1	Bit 2 is connected to the J2.C22 pin.
1	GA1	X	0/1	Bit 1 is connected to the J2.D22 pin.
0	GA0 (LSB)	X	0/1	Bit 0 is connected to the J2.E22 pin.

Trusted ePlatform Services

ADVANTECH

www.advantech.com

Please verify specifications before quoting. This guide is intended for reference purposes only.

All product specifications are subject to change without notice.

No part of this publication may be reproduced in any form or by any means, electronic, photocopying, recording or otherwise, without prior written permission of the publisher.

All brand and product names are trademarks or registered trademarks of their respective companies.

© Advantech Co., Ltd. 2007