

CPC-2520

VGA/LCD module for Mini Biscuit PC

User's Manual

Copyright notice

This document is copyrighted, October 1999. All rights are reserved. The original manufacturer reserves the right to make improvements to the products described in this manual at any time without notice.

No part of this manual may be reproduced, copied, translated or transmitted in any form or by any means without the prior written permission of the original manufacturer. Information provided in this manual is intended to be accurate and reliable. However, the original manufacturer assumes no responsibility for its use, nor for any infringements upon the rights of third parties which may result from its use.

Acknowledgements

AMI is a trademark of American Megatrends, Inc.

Cyrix is a trademark of Cyrix Corporation.

IBM, PC/AT, PS/2 and VGA are trademarks of International Business Machines Corporation.

Intel and Pentium are trademarks of Intel Corporation.

Microsoft Windows and MS-DOS are registered trademarks of Microsoft Corp.

C&T is a trademark of Chips and Technologies, Inc.

All other product names or trademarks are properties of their respective owners.

Product warranty

Advantech warrants to you, the original purchaser, that each of its products will be free from defects in materials and workmanship for one year from the date of purchase.

This warranty does not apply to any products that have been repaired or altered by persons other than repair personnel authorized by Advantech, or which have been subject to misuse, abuse, accident or improper installation. Advantech assumes no liability under the terms of this warranty as a consequence of such events.

Because of Advantech high quality-control standards and rigorous testing, most of our customers never need to use our repair service. If an Advantech product is defective, it will be repaired or replaced at no charge during the warranty period. For out-of-warranty repairs, you will be billed according to the cost of replacement materials, service time and freight. Please consult your dealer for more details. If you think you have a defective product, follow these steps:

1. Collect all the information about the problem encountered. (For example, CPU speed, Advantech products used, other hardware and software used, etc.) Note anything abnormal and list any on- screen messages you get when the problem occurs.
2. Call your dealer and describe the problem. Please have your manual, product, and any helpful information readily available.
3. If your product is diagnosed as defective, obtain an RMA (return merchandise authorization) number from your dealer. This allows us to process your return more quickly.
4. Carefully pack the defective product, a fully-completed Repair and Replacement Order Card and a photocopy proof of purchase date (such as your sales receipt) in a shippable container. A product returned without proof of the purchase date is not eligible for warranty service.
5. Write the RMA number visibly on the outside of the package and ship it prepaid to your dealer.

Packing list

Before installing your board, make sure that the following materials have been received:

- 1 CPC-2520 VGA/LCD module for mini biscuit PC
- 2 floppy disks (or one CD-ROM) including SVGA utility programs and drivers for Windows 95/98/NT
- 1 warranty certificate
- This user's manual

If any of these items are missing or damaged, contact your distributor or sales representative immediately.

Technical support and sales assistance

If you have any technical questions about the CPC-2520 or any other Advantech products, please visit our support website at:

<http://support.advantech.com.tw>

For more information about Advantech's products and sales information, please visit:

<http://www.advantech.com>

Contents

Chapter 1 General Information	1
1.1 Introduction	2
1.2 Specifications	3
General	3
Mechanical and environmental	3
1.3 Board layout: dimensions	4
Chapter 2 Installation	5
2.1 Jumpers and connectors	6
2.2 Board layout: jumper/connector locations	7
2.3 Safety precautions	8
2.4 Jumper settings	9
2.5 LCD Panel select (SW1)	10
2.6 Display connectors (CN2, CN3)	10
2.7 LCD display connector (CN2)	11
2.8 VGA display connector (CN3)	12
2.9 FPC cable installation	14
Chapter 3 Software Configuration	15
3.1 Introduction	16
3.2 Connections for five standard LCDs	16
Connections to Sharp LM64183P, LM64P89 (640 x 480 DSTN MONO LCD)	16
Connections to Toshiba LTM10C042 (640 x 480 TFT color LCD)	18
Connections to Sharp LM64C142 (640 x 480 DSTN color LCD)	19
Connections to Toshiba LTM12C275A (800 x 600 TFT color LCD)	20

Chapter 4 PCI SVGA Setup	21
4.1 Introduction	22
4.1.1 Chipset	22
4.1.2 Display memory	22
4.1.3 Display types	22
4.2 Installation of SVGA driver	23
4.2.1 Installation for Windows 3.1	24
4.2.2 Installation for Windows 95	26
4.2.3 Installation for Windows NT	29
4.3 Further information.....	32
Chapter 5 Board Diagrams	33
5.1 PCB layout: SODIMM/screw hole locations	34
5.2 Board layout: connectors (top view)	35
5.3 FPC/FFC layout: CN2: 50-pin FPC connector	36
5.4 FPC/FFC cable layout:	
CN3: 12-pin FPC connector	36
5.5 Height limitations: side view	37
5.6 Component suppliers	37

Tables

Table 2-1: Jumpers and connectors	6
Table 2-2: LCD display connector (CN2)	11
Table 2-3: VGA display connector (CN3)	12
Table 2-4: VGA display connector (CN3)	13
Table 3-1: Connections to Sharp LM64183P, LM64P89	16
Table 3-2: Connections to PLANAR EL	17
Table 3-3: Connections to Toshiba LTM10C042	18
Table 3-4: Connections to Sharp LM64C142	19
Table 3-5: Connections to Toshiba LTM12C275A	20
Table 5-1: Component suppliers	37

CHAPTER 1

General Information

This chapter provides background information for the CPC-2520. Sections include:

- Card specifications
- Board layout

1.1 Introduction

The CPC-2520 is an extension VGA/LCD module for the CPC-2245 mini biscuit PC. The CPC-2520 uses a C&T 69000 chipset for its PCI/SVGA controller. It supports many popular LCD, EL, and gas plasma flat panel displays and conventional analog CRT monitors. The 69000 VGA BIOS supports mono-chrome LCD, EL, color TFT and STN LCD flat panel displays. In addition, it also supports interlaced and non-interlaced analog monitors (color and mono-chrome VGA) in high-resolution modes while maintaining complete IBM VGA compatibility. Digital monitors (i.e. MDA, CGA, and EGA) are NOT supported. Multiple frequency (multi-sync) monitors are handled as if they were analog monitors.

With on-board 2 MB display memory, the VGA controller can drive CRT displays or color panel displays with resolutions up to 1024 x 768 at 64 K colors.

CRT and panel displays can be used simultaneously. The CPC-2520 can be set in one of three configurations: on a CRT, on a flat panel display, or on both simultaneously. The system is initially set to simultaneous display mode.

1.2 Specifications

General

- Flat panel VGA interface
- **Chipset:** C&T 69000 VGA controller with Windows accelerator
- **Display memory:** 2 MB SDRAM in built-in chip
- **Display output:**
50-pin FPC connector for flat panel interface
12-pin FPC connector for VGA interface
- **Display type:** Supports CRT and flat panel (TFT, DSTN, and mono) displays. Can display both CRT and flat panel simultaneously
- **Resolution:** 640 x 480 @ 16 M colors
800 x 600 @ 16 M colors
1024 x 768 @ 64 K colors

Mechanical and environmental

- **Power supply voltage:** +5 V (4.75 V ~ 5.25 V)
- **Max. power requirements:** +5 V @ 0.8 A
- **Operating temperature:** 0 ~ 60° C (32 ~ 140° F)
- **Board size:** 68 x 100 mm (2.7" x 3.9")
- **Weight:** 0.05 kg (0.11 lb)

1.3 Board layout: dimensions

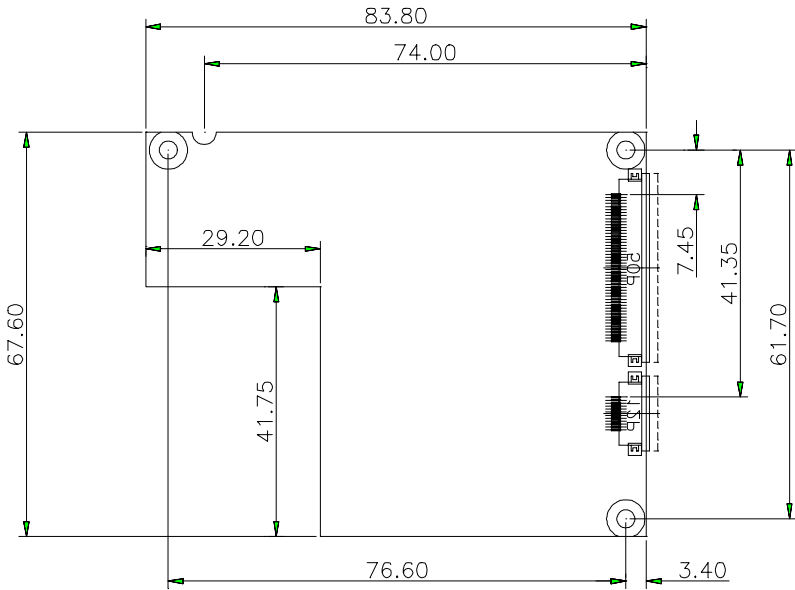

CHAPTER 2

Installation

This chapter explains the setup procedures of CPC-2520 hardware, including instructions on setting jumpers and connecting peripherals, switches and indicators. Be sure to read all safety precautions before you begin the installation procedure.

2.1 Jumpers and connectors

On-board connectors link to external devices such as hard disk drives, keyboards, or floppy drives, etc. In addition, the board has jumpers for configuring your board for specific applications.

The table below lists the function of each of the board's jumpers and connectors. Later sections in this chapter give detailed information on each jumper setting, and gives instructions for connecting external devices to your card.

Table 2-1: Jumpers and connectors

Number	Function
SW1	LCD panel type setting
CN1	Reserved for VGA testing
CN2	LCD display connector
CN3	VGA display connector
CN4	PCI bus

2.2 Board layout: jumper/connector locations

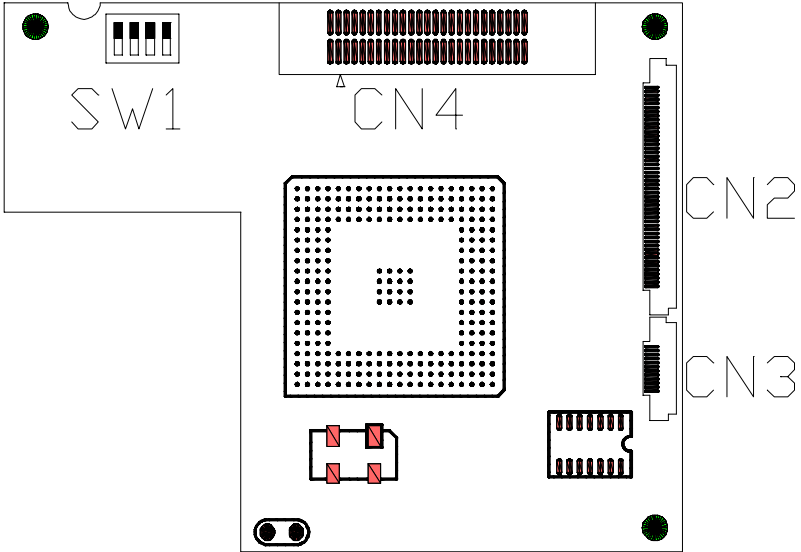

2.3 Safety precautions

Warning!



Always completely disconnect the power cord from your chassis whenever you are working on it. Do not make connections while the power is on because sensitive electronic components can be damaged by the sudden rush of power. Only experienced electronics personnel should open the PC chassis.

Caution!



Always ground yourself to remove any static charge before touching the CPU card. Modern electronic devices are very sensitive to static electric charges. Use a grounding wrist strap at all times. Place all electronic components on a static-dissipative surface or in a static-shielded bag when they are not in the chassis.

2.4 Jumper settings

You configure your card to match the needs of your application by setting jumpers. A jumper is the simplest kind of electric switch. It consists of two metal pins and a small metal clip (often protected by a plastic cover) that slides over the pins to connect them. To close a jumper you connect the pins with the clip. To open a jumper you remove the clip. Sometimes a jumper will have three pins, labeled 1, 2 and 3. In this case you would connect either pins 1 and 2 or 2 and 3.

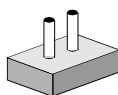

Open

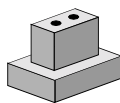

Closed

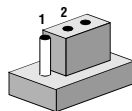

Closed 2-3

A pair of needle-nose pliers may be helpful when working with jumpers. If you have any doubts about the best hardware configuration for your application, contact your local distributor or sales representatives before you make any changes.

2.5 LCD panel select (SW1)

Panel #	SW1				Panel Type
	A	B	C	D	
1	ON	ON	ON	ON	1024 x 768 DSTN
2	OFF	ON	ON	ON	1280 x 1024 TFT
3	ON	OFF	ON	ON	640 x 480 DSTN
4	OFF	OFF	ON	ON	800 x 600 DST
5	ON	ON	OFF	ON	640 x 480 Sharp TFT
6	OFF	ON	OFF	ON	640 x 480 18-bit TFT
7	ON	OFF	OFF	ON	1024 x 768 36-bit TFT
8	OFF	OFF	OFF	ON	800 x 600 TFT
9	ON	ON	ON	OFF	800 x 600 TFT (large BIOS only)
10	OFF	ON	ON	OFF	800 x 600 TFT (large BIOS only)
11	ON	OFF	ON	OFF	800 x 600 DSTN (large BIOS only)
12	OFF	OFF	ON	OFF	800 x 600 DSTN (large BIOS only)
13	ON	ON	OFF	OFF	1024 x 768 TFT (large BIOS only)
14	OFF	ON	OFF	OFF	1280 x 1024 DSTN (large BIOS only)
15	ON	OFF	OFF	OFF	1024 x 600 DSTN (large BIOS only)
16	OFF	OFF	OFF	OFF	1024 x 600 TFT (large BIOS only)

2.6 Display connectors (CN2, CN3)

The CPC-2520 PCI SVGA interface can drive conventional CRT display and is capable of driving a wide range of flat display, including electroluminescent (EL), gas plasma, passive LCD, and active LCD displays. The card has two connectors to support these display, one for CRT VGA monitor and one for flat panel displays.

2.7 LCD display connector (CN2)

LCD display connector on CPC-2520 is a 50-pin FPC connector. The CPC-2520 supports up to 36 bits LCD panel.

Table 2-2: LCD display connector (CN2)

Pin	Signal	Pin	Signal
1	ENAVEE	26	P15
2	LP	27	P16
3	ENAVDD	28	P17
4	FLM	29	P18
5	SHIFT CLK	30	P19
6	SHIFT CLK-	31	GND
7	M	32	P20
8	ENABKL	33	P21
9	GND	34	P22
10	P0	35	P23
11	P1	36	P24
12	P2	37	P25
13	P3	38	P26
14	P4	39	P27
15	P5	40	GND
16	P6	41	P28
17	P7	42	P29
18	GND	43	P30
19	P8	44	P31
20	P9	45	P32
21	P10	46	P33
22	P11	47	P34
23	P12	48	P35
24	P13	49	GND
25	P14	50	GND

Note: The model number of the CN2 socket is IL-FPR-50S-HF (JAE Co., Ltd.)

2.8 VGA display connector (CN3)

VGA display connector on CPC-2520 is a 12-pin FPC connector, these VGA signals can be connected to client's system board through a FPC cable. Client can design this cable by referring to Cable layout diagram in chapter of design guide.

Table 2-3: VGA display connector (CN3)

Pin	Signal
1	GND
2	+5V
3	+5V
4	GND
5	H SYNC
6	DDC1
7	V SYNC
8	DDC0
9	BLUE
10	RED
11	GREEN
12	GND

Note: *The model number of the CN3 socket is IL-FPR-12S-HFC (JAE Co., Ltd.)*

The VGA connector is a 15-pin D-SUB connector. User can follow a transfer table to layout these VGA signals to a standard 15-pin D-SUB connector.

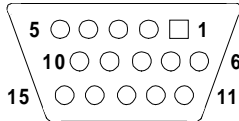
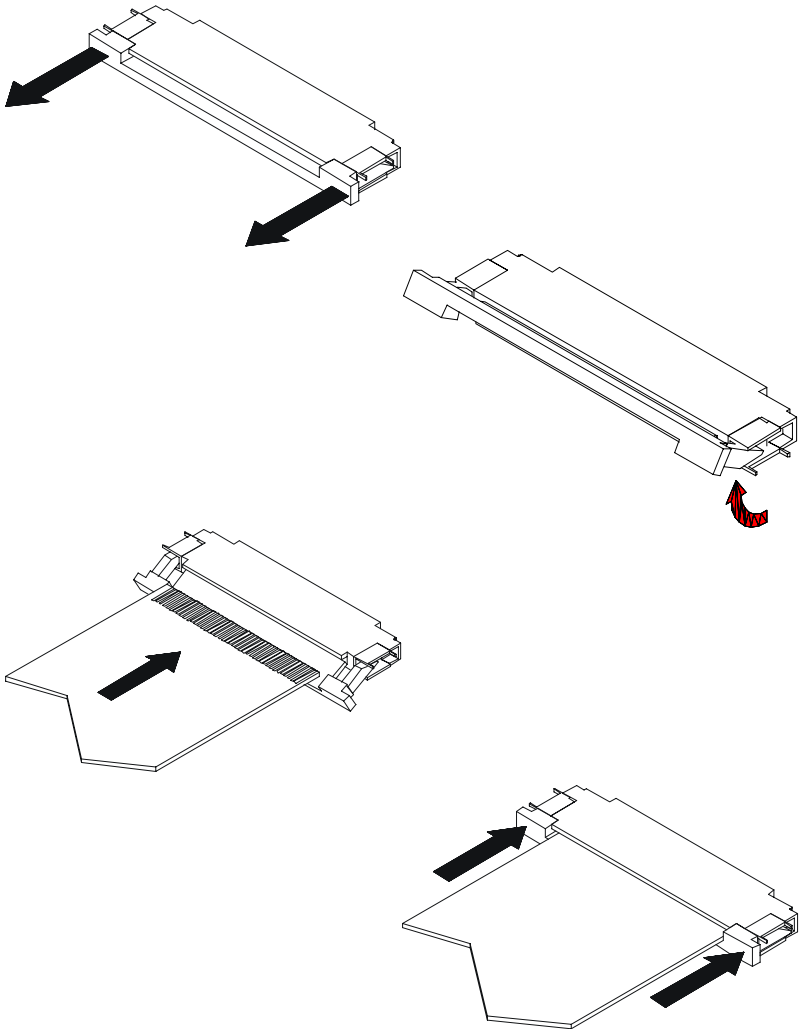

Table 2-4: VGA display connector (CN3)

VGA Pin	VGA Signal	CN3 Pin	CN3 Signal	VGA Pin	VGA Signal	CN3 Pin	CN3 Signal
1	RED	10	RED	9	Vcc	2, 3	+V
2	GREEN	11	GREEN	10	GND	4	GND
3	BLUE	9	BLUE	11	N/C	-	-
4	N/C	-	-	12	SDT	8	DDC0
5	GND	1	GND	13	H-SYNC	5	H SYNC
6	GND	1	GND	14	V-SYNC	7	V SYNC
7	GND	12	GND	15	SCK	6	DDC1
8	GND	12	GND				

2.9 FPC cable installation



CHAPTER 3

Software Configuration

This chapter details the software configuration information. It shows you how to configure the card to match your application requirements.

Sections include:

- Introduction
- Connections for five standard LCDs

3.1 Introduction

The CPC-2520 VGA BIOS are located in a 128 Kbyte, 32-pin (JEDEC spec.) Flash ROM device, designated U1. To set different types of LCD panels please choose Panel type from the DIP Switch.

3.2 Connections for five standard LCDs

Connections to Sharp LM64183P, LM64P89 (640 x 480 DSTN MONO LCD)

Table 3-1: Connections to Sharp LM64183P, LM64P89

LM64183/64P89		CPC-2520 CN2	
Pin	Name	Pin	Name
CN1-1	S	4	FLM
CN1-2	CP1	2	LP
CN1-3	CP2	5	SHIFT CLK
CN1-4	DISP	-	External power (+5 V)
CN1-5	VDD	-	External power (+5 V)
CN1-6	VSS	18,31,40	GND
CN1-7	VEE	-	External power*
CN1-8	DU0	13	P3
CN1-9	DU1	12	P2
CN1-10	DU2	11	P1
CN1-11	DU3	10	P0
CN1-12	DL0	17	P7
CN1-13	DL1	16	P6
CN1-14	DL2	15	P5
CN1-15	DL3	14	P4

*LM64183P-17 V

*LM64P89-20 V

Connections to PLANAR EL (640 x 480 AD4 EL)

Table 3-2: Connections to PLANAR EL

PLANAR 640 x 480 AD4		CPC-2520 CN2	
Pin	Name	Pin	Name
1	GND	9	GND
2	DO	23	P12
3	GND	9	GND
4	D1	24	P13
5	GND	18	GND
6	D2	25	P14
7	NC	-	-
8	D3	26	P15
9	NC	-	-
10	D4	19	P8
11	NC	-	-
12	D5	20	P9
13	NC	-	-
14	D6	21	P10
15	GND	18	GND
16	D7	22	P11
17	GND	31	GND
18	VCLK	6	SHIFT CLK-
19	GND	31	GND
20	/BLANK	-	-
21	GND	40	GND
22	HS	7	M
23	NC	-	-
24	VS	4	FLM
25	NC	-	-
26	SELFTST	40	GND
27	COLMAP	49	GND
28	ENABLE	-	-
29	RESERVED	-	-
30	/LOWPOW	-	-
31,32	NC	-	-
33	RESERVED	-	-
34	NC	-	-

Connections to Toshiba LTM10C042 (640 x 480 TFT color LCD)

Table 3-3: Connections to Toshiba LTM10C042

LTM10C042		CPC-2520 CN2	
Pin	Name	Pin	Name
1	GND	9	GND
2	CLK	5	SHIFT CLK
3	GND	9	GND
4	R0	29	P18
5	R1	30	P19
6	R2	32	P20
7	GND	18	GND
8	R3	33	P21
9	R4	34	P22
10	R5	35	P23
11	GND	18	GND
12	G0	21	P10
13	G1	22	P11
14	G2	23	P12
15	GND	31	GND
16	G3	24	P13
17	G4	25	P14
18	G5	26	P15
19	GND	31	GND
20	ENAB	7	M
21	GND	40	GND
22	B0	12	P2
23	B1	13	P3
24	B2	14	P4
25	GND	40	GND
26	B3	15	P5
27	B4	16	P6
28	B5	17	P7
29	GND	49	GND
30	VDD	-	External power
31, 32	VDD	-	External power

Connections to Sharp LM64C142 (640 x 480 DSTN color LCD)

Table 3-4: Connections to Sharp LM64C142

LM64C142		CPC-2520 CN2	
Pin	Name	Pin	Name
CN1-1	YD	4	FLM
CN1-2	LP	2	LP
CN1-3	XCX	5	SHIFT CLK
CN1-4	DISP	-	External power (+5 V)
CN1-5	VDD	-	External power (+5 V)
CN1-6	VSS	9	GND
CN1-7	VEE	-	External power
CN1-8	DU0	22	P11
CN1-9	DU1	21	P10
CN1-10	DU2	20	P9
CN1-11	DU3	19	P8
CN1-12	DU4	13	P3
CN1-13	DU5	12	P2
CN1-14	DU6	11	P1
CN1-15	DU7	10	P0
CN2-1	VSS	18	GND
CN2-2	DL0	26	P15
CN2-3	DL1	25	P14
CN2-4	DL2	24	P13
CN2-5	DL3	23	P12
CN2-6	DL4	17	P7
CN2-7	DL5	16	P6
CN2-8	DL6	15	P5
CN2-9	DL7	14	P4
CN2-10	VSS	31	GND

Connections to Toshiba LTM12C275A (800 x 600 TFT color LCD)

Table 3-5: Connections to Toshiba LTM12C275A

LTM12C275A		CPC-2520 CN2	
Pin	Name	Pin	Name
1	GND	9	GND
2	NCLK	5	SHIFT CLK
3	NC	-	NC
4	NC	-	NC
5	GND	9	GND
6	R0	29	P18
7	R1	30	P19
8	R2	32	P20
9	R3	33	P21
10	R4	34	P22
11	R5	35	P23
12	GND	18	GND
13	G0	21	P10
14	G1	22	P11
15	G2	23	P12
16	G3	24	P13
17	G4	25	P14
18	G5	26	P15
19	GND	31	GND
20	B0	12	P2
21	B1	13	P3
22	B2	14	P4
23	B3	15	P5
24	B4	16	P6
25	B5	17	P7
26	ENAB	7	M
27	GND	40	GND
28	VCC	-	External power (+5 V)
29	VCC	-	External power (+5 V)
30	GND	49	GND

CHAPTER
4

PCI SVGA Setup

- Introduction
- Installation of SVGA driver for
 - Windows 3.1
 - Windows 95
 - Windows NT
- Further information

4.1 Introduction

The CPC-2520 has an on-board PCI flat panel/VGA interface. The specifications and features are described as follows:

4.1.1 Chipset

The CPC-2520 uses a C&T 69000/69030 chipset for its PCI/SVGA controller. It supports many popular LCD, EL, and gas plasma flat panel displays and conventional analog CRT monitors. The 69000/69030 VGA BIOS supports monochrome LCD, EL, color TFT and STN LCD flat panel displays. In addition, it also supports interlaced and non-interlaced analog monitors (color and mono-chrome VGA) in high-resolution modes while maintaining complete IBM VGA compatibility. Digital monitors (i.e. MDA, CGA, and EGA) are NOT supported. Multiple frequency (multi-sync) monitors are handled as if they were analog monitors.

4.1.2 Display memory

With on-board 2 MB display memory, the VGA controller can drive CRT displays or color panel displays with resolutions up to 1024 x 768 at 64 K colors. The display memory can be expanded to 4 MB for true-color resolution of 1024 x 768 with C&T 69030.

4.1.3 Display types

CRT and panel displays can be used simultaneously. The CPC-2520 can be set in one of three configurations: on a CRT, on a flat panel display, or on both simultaneously. The system is initially set to simultaneous display mode. The utility disks includes three *.COM files in the subdirectory Utility\vga\ which can be used to configure the display. In order to use these configuration programs, type the file name and path at the DOS prompt.

CT.COM: Enables CRT display only

FP.COM: Enables panel display only

SM.COM: Enables both displays simultaneously

4.2 Installation of SVGA driver

Complete the following steps to install the SVGA driver. Follow the procedures in the flow chart that apply to the operating system that you are using within your CPC-2520.

Important: The following windows illustrations are examples only. You must follow the flow chart instructions and pay attention to the instructions which then appear on your screen.

Note: <Enter> means pressing the "Enter" key on the keyboard.

4.2.1 Installation for Windows 3.1

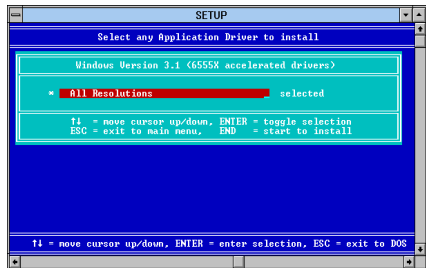
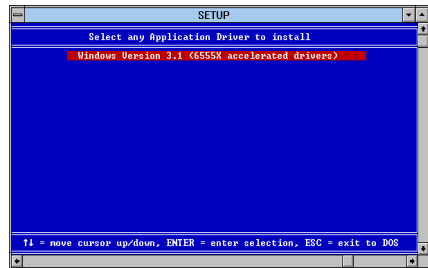
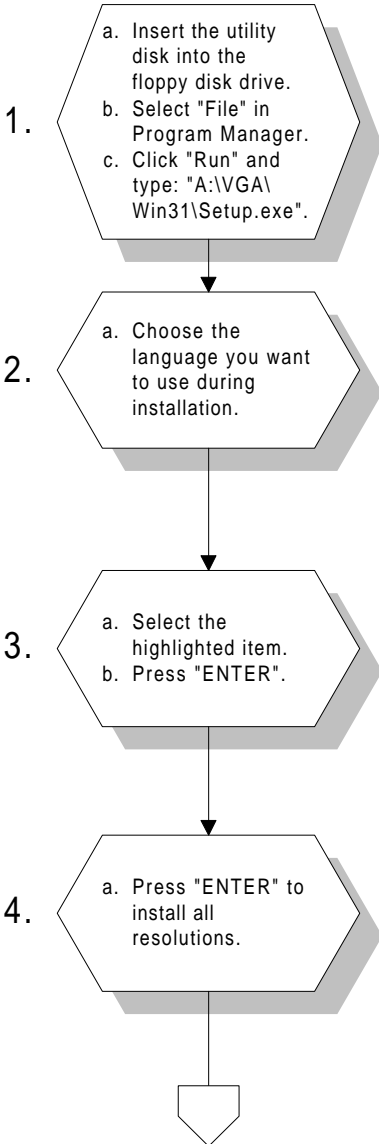

5.

- a. Type the path of the operating system.

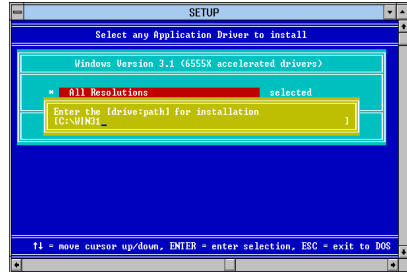

6.

- a. When installation is completed, reboot the system.
- b. You will see the "ChipsCPL" icon in the control panel.

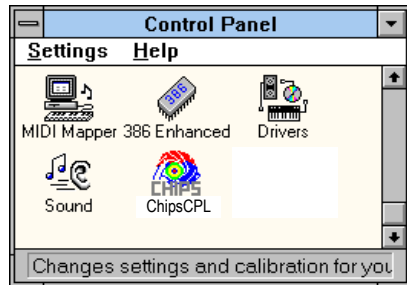

7.

- a. Double click "ChipsCPL".
- b. Adjust screen size, color and refresh rate to your preferences.

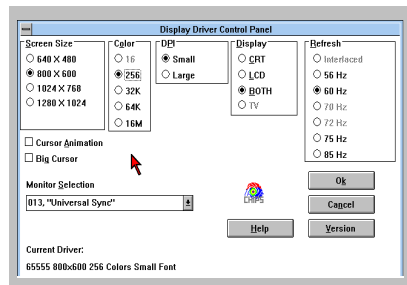

END

4.2.2 Installation for Windows 95

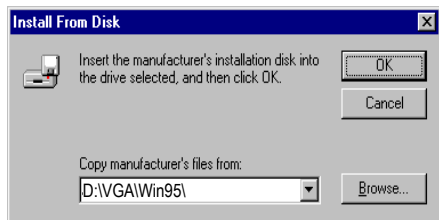
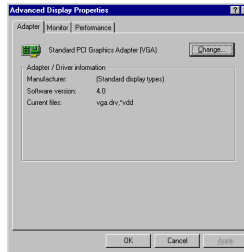
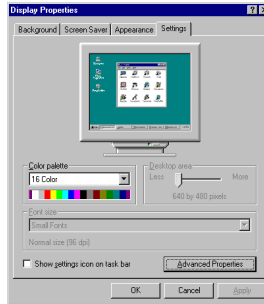
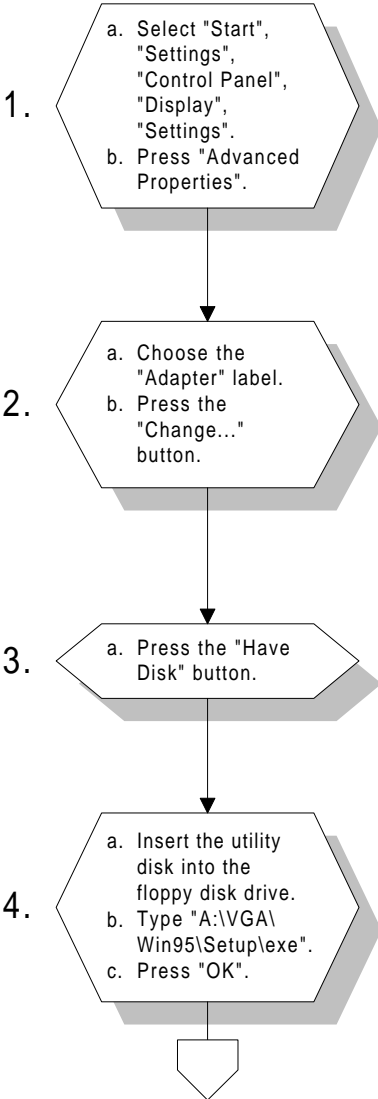

5.

- a. Select the highlighted item.
- b. Click the "OK" button.

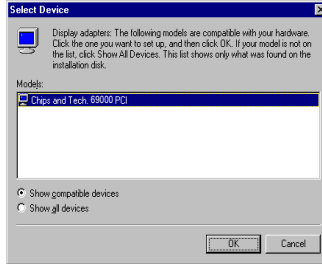

6.

- a. C&T69000/69030 appears in the adapter label.
- b. Click the "Apply" button.

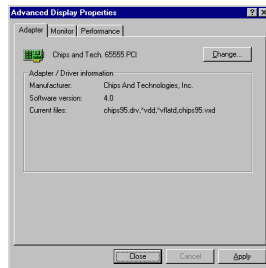

7.

- a. Press "Yes" to reboot.

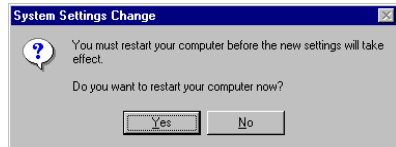

8.

- a. Repeat Step 1 on the previous page of this manual. The "CHIPS" label appears in "Display".
- b. Adjust resolution and color.

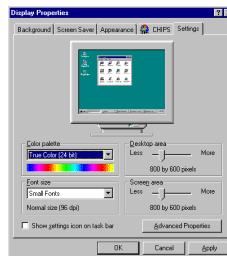

9.

- a. Click the "CHIPS" label.
- b. Adjust the refresh rate and display type.
- c. Press "OK" to exit.

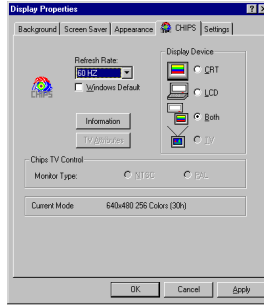

10.

- a. Press "Yes" to set the monitor type.

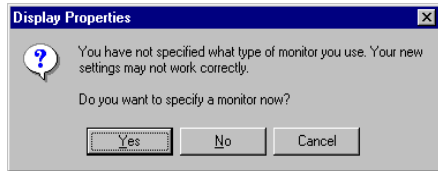

11.

- a. Select "Standard", "Super VGA 800 x 600", or "XGA".
- b. Press the "OK" button.

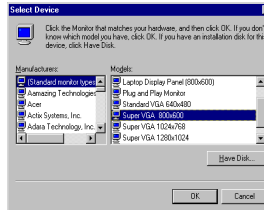

12.

- a. Choose "Restart" to reboot.

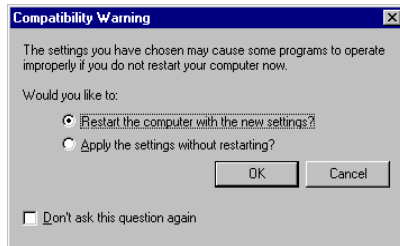

END

4.2.3 Installation for Windows NT

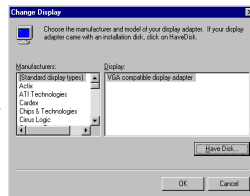
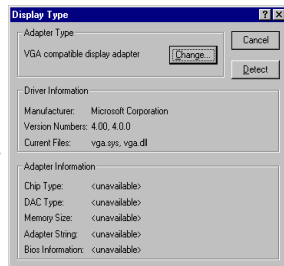
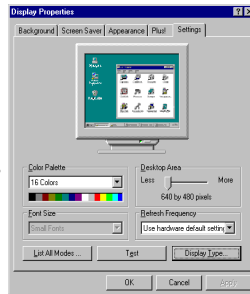
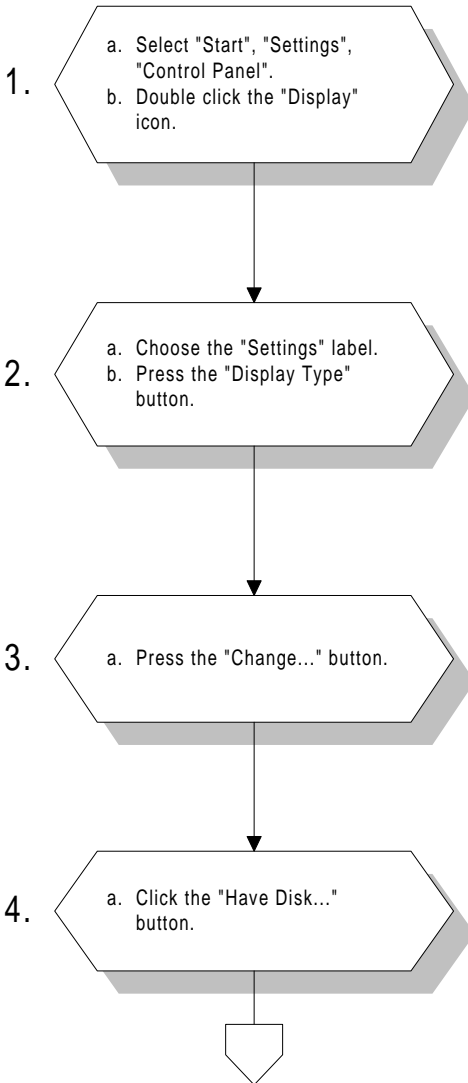

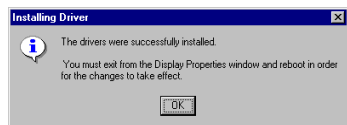
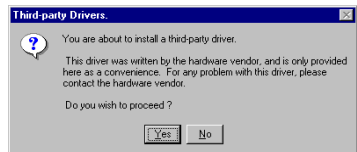
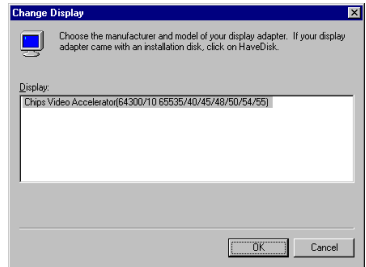
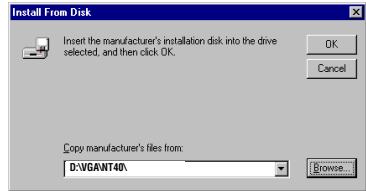
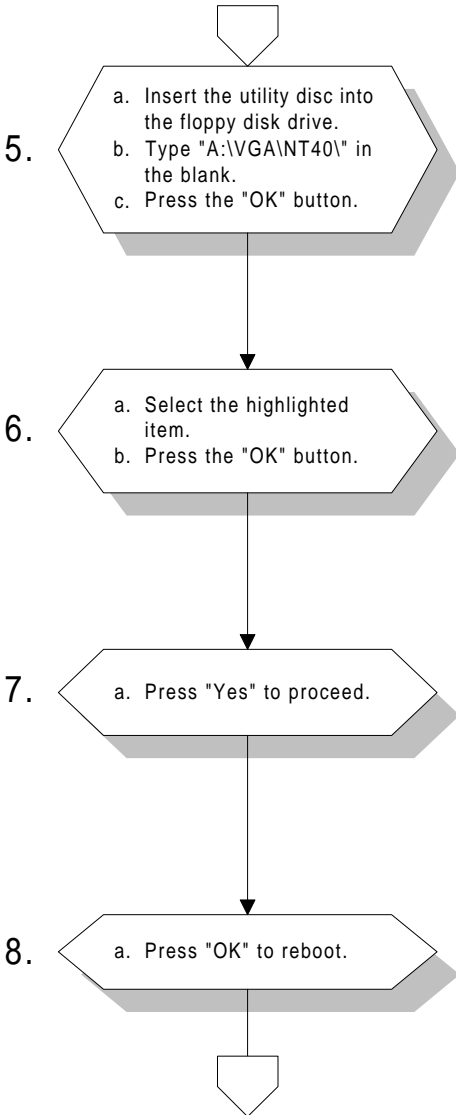

9.

- a. Repeat Step 1 in this manual, to select the "Settings" label.
- b. Adjust resolution and color.
- c. Click "Test" to see the result.
- d. Click "OK" to save the settings.

END

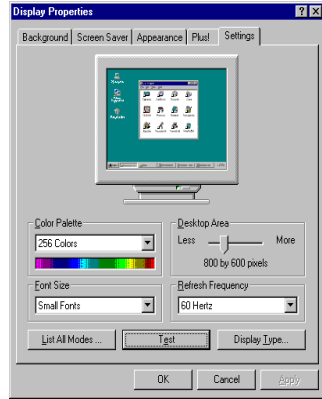

4.3 Further information

For further information about PCI/SVGA installation in your CPC-2520, including driver updates, troubleshooting guides and FAQ lists, visit the following web resources:

C&T website: **www.chips.com**

Advantech websites: **www.advantech.com**
support.advantech.com.tw

CHAPTER 5

Board Diagrams

This chapter contains diagrams of the CPC-2245/CPC-2520 carrier boards. It includes the FPC cable, SODIMM socket, and mechanical diagrams.

5.1 PCB layout: SODIMM/screw hole locations

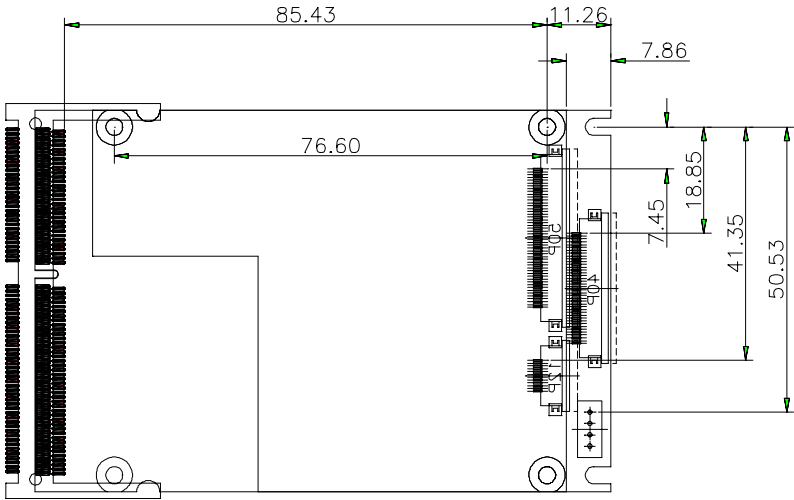

5.2 Board layout: connectors (top view)

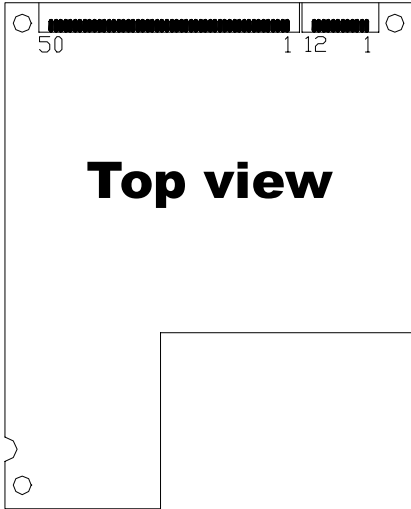

5.3 FPC/FFC layout: CN2: 50-pin FPC connector

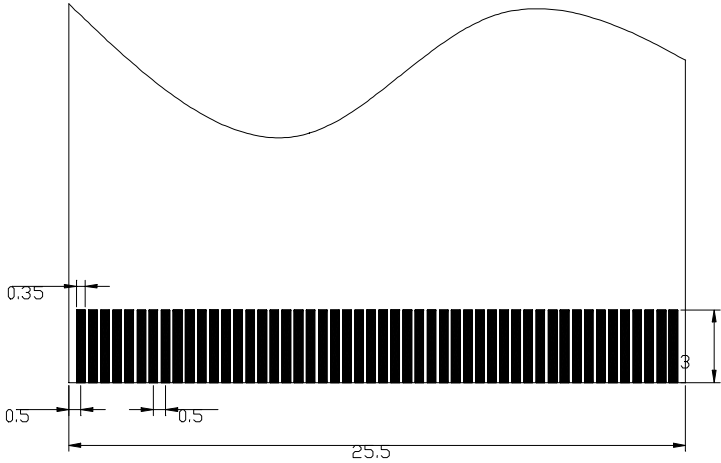

5.4 FPC/FFC cable layout: CN3: 12-pin FPC connector

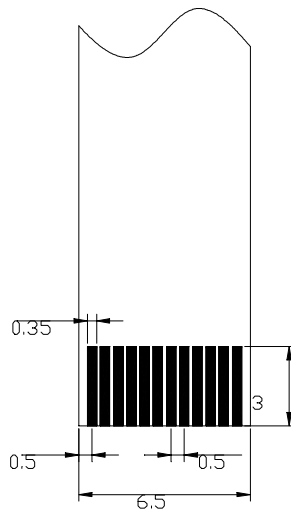

5.5 Height limitations: side view

At least 3 mm clearance is needed between the carrier board's surface and the bottom of the CPC-2245. Some suggested suppliers are listed below.

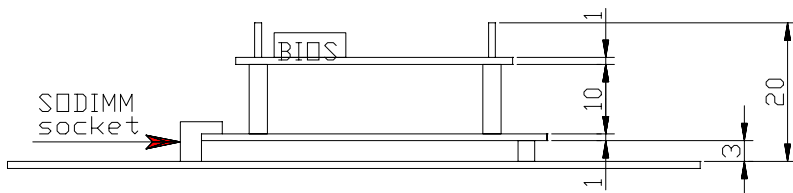

5.6 Component suppliers

Table 5-1: Component suppliers

Location	Model number	Supplier
CN2 50-pin FPC connector	IL-FPR-50S-HF	JAE
CN3 12-pin FPC connector	IL-FPR-12S-HF	JAE
CN4 50-pin FPC connector	145077050112861	ELCO

