

CPC-2420

2.5" Carrier Board for Mini Biscuit PC

User's Manual

Copyright notice

This document is copyrighted, 2000, by Advantech Co., Ltd. All rights are reserved. The original manufacturer reserves the right to make improvements to the products described in this manual at any time without notice.

No part of this manual may be reproduced, copied, translated or transmitted in any form or by any means without the prior written permission of the original manufacturer. Information provided in this manual is intended to be accurate and reliable. However, the original manufacturer assumes no responsibility for its use, nor for any infringements upon the rights of third parties which may result from such use.

Acknowledgements

IBM, PC/AT, PS/2 and VGA are trademarks of International Business Machines Corporation.

Intel and Pentium are trademarks of Intel Corporation.

Microsoft Windows and MS-DOS are registered trademarks of Microsoft Corp.

C&T is a trademark of Chips and Technologies, Inc.

All other product names or trademarks are properties of their respective owners.

Product warranty

Advantech warrants to you, the original purchaser, that each of its products will be free from defects in materials and workmanship for one year from the date of purchase.

This warranty does not apply to any products that have been repaired or altered by persons other than repair personnel authorized by Advantech, or which have been subject to misuse, abuse, accident or improper installation. Advantech assumes no liability under the terms of this warranty as a consequence of such events.

Because of Advantech high quality-control standards and rigorous testing, most of our customers never need to use our repair service. If an Advantech product is defective, it will be repaired or replaced at no charge during the warranty period. For out-of-warranty repairs, you will be billed according to the cost of replacement materials, service time and freight. Please consult your dealer for more details. If you think you have a defective product, follow these steps:

1. Collect all the information about the problem encountered. (For example, CPU speed, Advantech products used, other hardware and software used, etc.) Note anything abnormal and list any on-screen messages you get when the problem occurs.
2. Call your dealer and describe the problem. Please have your manual, product, and any helpful information readily available.
3. If your product is diagnosed as defective, obtain an RMA (return merchandise authorization) number from your dealer. This allows us to process your return more quickly.
4. Carefully pack the defective product, a fully-completed Repair and Replacement Order Card and a photocopy proof of purchase date (such as your sales receipt) in a shippable container. A product returned without proof of the purchase date is not eligible for warranty service.
5. Write the RMA number visibly on the outside of the package and ship it prepaid to your dealer.

Packing list

Before installing your board, make sure that the following materials have been received:

- 1 CPC-2420 carrier board for CPC-2245 mini biscuit PC
- 1 warranty certificate
- This user's manual
- 1 40-pin FPC cable (part no. 1701400301)
- 1 50-pin FPC cable (part no. 1701500700)
- Y cable (part no. 1700060201)
- HDD cable (part no. 1701440500)
- FDD cable (part no. 1701340600)
- LPT cable (part no. 1703340300)
- COM cable (part no. 1700100250)
- Phoenix power connector (part no. 1652002101)
- Power cable (part no. 1703050050)

If any of these items are missing or damaged, contact your distributor or sales representative immediately.

Technical support and sales assistance

If you have any technical questions about the CPC-2420 or any other Advantech products, please visit our support website at:

<http://www.advantech.com/support>

For more information about Advantech's products and sales information, please visit:

<http://www.advantech.com>

Contents

Chapter 1 Hardware Configuration	1
1.1 Introduction	2
1.2 Specifications	2
1.3 Safety precautions	3
1.4 Jumper settings	4
1.4.1 LCD 3.3/5 V select (J6)	4
1.4.2 Reset (J3)	4
1.5 Board layout: dimensions	5
1.6 Installing a Mini Biscuit PC	7
Chapter 2 Connecting Peripherals	9
2.1 Board layout: connector locations	10
2.2 Floppy drive/parallel port connector (CN2)	12
2.4 VGA display connector (CN3)	12
2.5 Ethernet configuration (CN4)	13
2.6 Enhanced IDE connector (CN5)	13
2.7 Power connector (CN6/CN15).....	13
2.8 Keyboard and PS/2 mouse connector (CN7)	14
2.9 24-bit LCD display connector (CN8).....	14
2.10 LCD inverter connector (CN9)	14
2.11 Serial ports	
(CN10: COM1/RS-232; CN12: COM2/RS-232)	14
2.11.1 RS-232 connection (COM1: CN10)	14
2.11.2 RS-232 connection (COM2: CN12)	15
2.12 36-bit LCD display connector (CN11).....	15
2.13 ISA connector (J1/J2)	15

Appendix A Pin Assignments	17
A.1 Floppy drive/parallel port connector (CN2)	18
A.2 CRT display connector (CN3).....	20
A.3 IDE hard drive connector (CN5)	21
A.4 Power connector (CN6)	22
A.5 Keyboard and mouse connector (CN7)	22
A.6 24-bit LCD display connector (CN8).....	23
A.7 LCD power inverter (CN9)	24
A.8 COM1 RS-232 serial port (CN10)	24
A.9 36-bit LCD display connector (CN11).....	25
A.10 COM2 RS-232 serial port (CN12)	26
A.11 Phoenix power connector (CN15)	26
A.12 ISA-bus FPC connector (J1/J2)	27
A.13 Board layout: locations of Pin 1 of J1 and J2	29
A.14 FPC cable layout (J1/J2; 50-pin FPC connector).....	31

Tables

Table 1-1: LCD 3.3/5 V VDD select (J6)	4
Table 2-1: Connectors	11
Table 2-2: CPC-2420 serial port default settings	15
Table A-1: Parallel port connector (CN2)	18
Table A-2: Floppy drive connector (CN2)	19
Table A-3: CRT display connector (CN3)	20
Table A-4: IDE hard drive connector (CN5)	21
Table A-5: Power connector (CN6)	22
Table A-6: Keyboard and mouse connector (CN7)	22
Table A-7: 24-bit LCD display connector (CN8)	23
Table A-8: LCD power inverter (CN9)	24
Table A-9: COM1 RS-232 serial port (CN10)	24
Table A-10: 36-bit LCD display connector (CN11)	25
Table A-11: COM2 RS-232 serial port (CN12)	26
Table A-12: Phoenix power connector (CN15)	26
Table A-13: ISA- bus FPC connector (J1)	27
Table A-14: ISA-bus FPC connector (J2)	28

Figures

Figure 1-1: Board layout: dimensions (component side)	5
Figure 1-2: Board layout: dimensions (solder side)	6
Figure 1-3: Installation of FPC cable	8
Figure 2-1: Board layout: connector locations (component side)	10
Figure 2-2: Board layout: connector locations (solder side)	10
Figure A-1: Board layout: location of Pin 1 of J2 (component side)	29
Figure A-2: Board layout: location of Pin 1 of J1 (solder side)	30
Figure A-3: FPC cable layout	31

Hardware Configuration

This chapter gives background information on the CPC-2420. It shows you how to configure the board to match your application and prepare it for installation into your PC.

Sections include:

- Introduction
- Specifications
- Safety precautions
- Jumper settings
- Board layout: dimensions

1.1 Introduction

The CPC-2420 is a carrier board designed with a SODIMM socket for connection to a Mini Biscuit PC. It also has connectors for functions such as VGA, LCD, LAN, FDD, IDE, ISA and a printer port. The CPC-2420 can help users design their own board easier.

1.2 Specifications

- Two FPC connectors for ISA-bus expansion
- DB-15 VGA connector
- RJ-45 Ethernet connector
- DB-9 COM1 serial port connector
- 10-pin COM2 serial port box header
- LCD connector
- One FDD/LPT connector
- 44-pin HDD connector
- 6-pin PS/2 KB/mouse connector
- Size: 120 x 82 mm
- Weight: 80 g

1.3 Safety precautions

The following sections tell how to make each connection. In most cases, you will simply need to connect a standard cable. All of the connector pin assignments are shown in Appendix A.

Warning!



Always completely disconnect the power cord from your PC chassis whenever you are working on it. Do not make connections while the power is on. Sensitive electronic components can be damaged by a sudden rush of power. Only experienced electronics personnel should open the PC chassis.

Caution!



Always ground yourself to remove any static charge before touching any PC board or card. Modern electronic devices are very sensitive to static electric charges. Use a grounding wrist strap at all times. Place all electronic components on a static-dissipative surface or in a static-shielded bag when they are not in the PC chassis.

1.4 Jumper settings

This section tells how to set the jumpers to configure your board. It gives the board default configuration and your options for each jumper. After you set the jumpers and install the board, you will also need to run your BIOS Setup program to configure the serial port addresses, floppy/hard disk drive types and system operating parameters. Connections, such as hard disk cables, appear in Chapter 2.

You configure your board to match the needs of your application by setting jumpers. A jumper is the simplest kind of electric switch. It consists of two metal pins and a small metal cap (often protected by a plastic cover) that slides over the pins to connect them. To "close" a jumper, connect the pins with the cap. To "open" a jumper, remove the cap. Sometimes a jumper will have three pins, labeled 1, 2 and 3. In this case, connect either pins 1 and 2 or 2 and 3.

You may find a pair of needle-nose pliers useful for setting the jumpers.

If you have any doubts about the best hardware configuration for your application, contact your local distributor or sales representative before you make any changes.

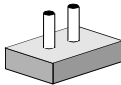

Open

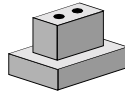

Closed

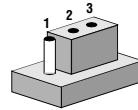

Closed 2 - 3

1.4.1 LCD 3.3/5 V select (J6)

This jumper is used to decide LCD supply voltage.

Table 1-1: LCD 3.3/5 V V_{DD} select (J6)

Function	Pins 1-2	Pins 2-3
5 V	Closed	Open
3.3 V	Open	Closed

1.4.2 Reset (J3)

Connect a wire from a reset button to J3. To "close" J3 will activate a reset.

1.5 Board layout: dimensions

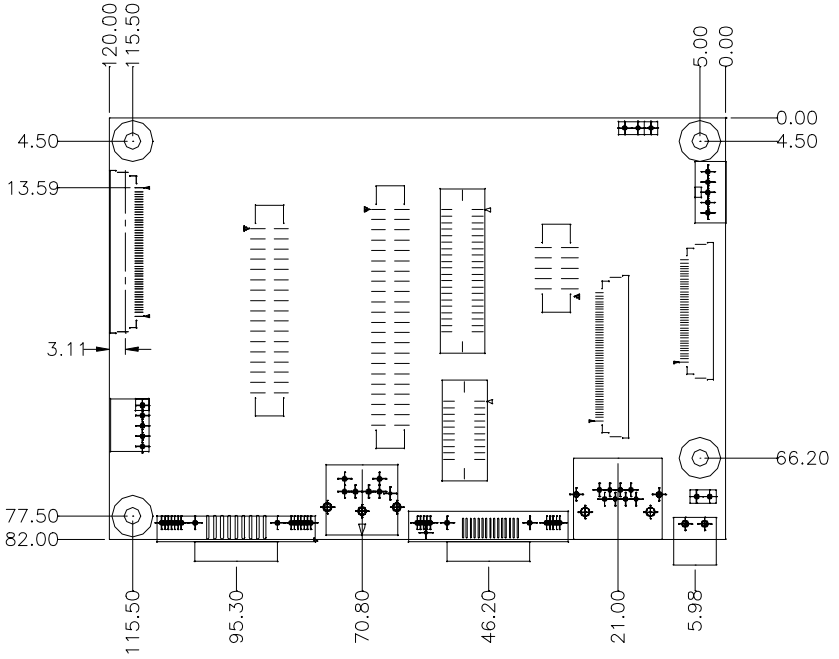

Figure 1-1: Board layout: dimensions (component side)

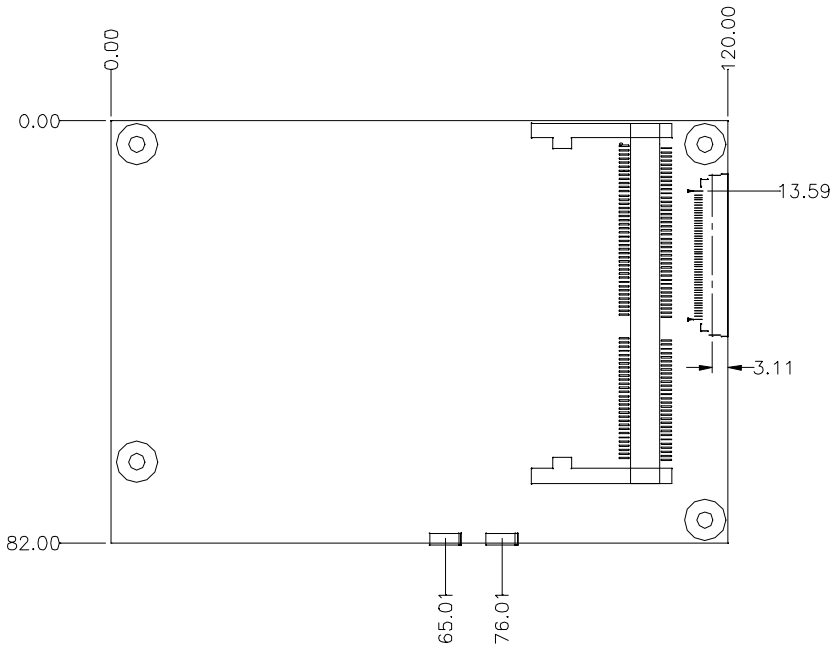

Figure 1-2: Board layout: dimensions (solder side)

1.6 Installing a Mini Biscuit PC

Note: The modules can fit into the socket only one way: the gold pins must point down into the SODIMM socket.

The procedure for installing a Mini Biscuit PC into the SODIMM socket of the CPC-2420 appears below. Please follow these steps carefully.

1. Make sure that all power supplies to the system are switched off.
2. Attach the copper support to the CPC-2420 by fastening the two thumbscrews.
3. Install the Mini Biscuit PC card (eg. CPC-2245, etc.). Install the Mini Biscuit PC card so that its gold pins point down into the SODIMM socket.
4. Slip the Mini Biscuit PC card into the socket at a 45 degree angle, and carefully push the bottom of the card against the connectors.
5. Gently push the Mini Biscuit PC card into a perpendicular position until the clips on the ends of the SODIMM socket snap into place.
6. Make sure that the Mini Biscuit PC card is correctly seated, and that all connectors make contact. The mini Biscuit PC card should fit snugly in its socket.
7. Pull out the FPC connector. Plug the FPC cable into the FPC connector, and then push in the FPC connector. (see Fig. 1-3). Connect the 40-pin FPC cable to J5 of the CPC-2420, and to the Mini Biscuit PC's FPC connector. The 50-pin FPC cable connects to J4 of the CPC-2420, and to VGA/LCD module's FPC connector.

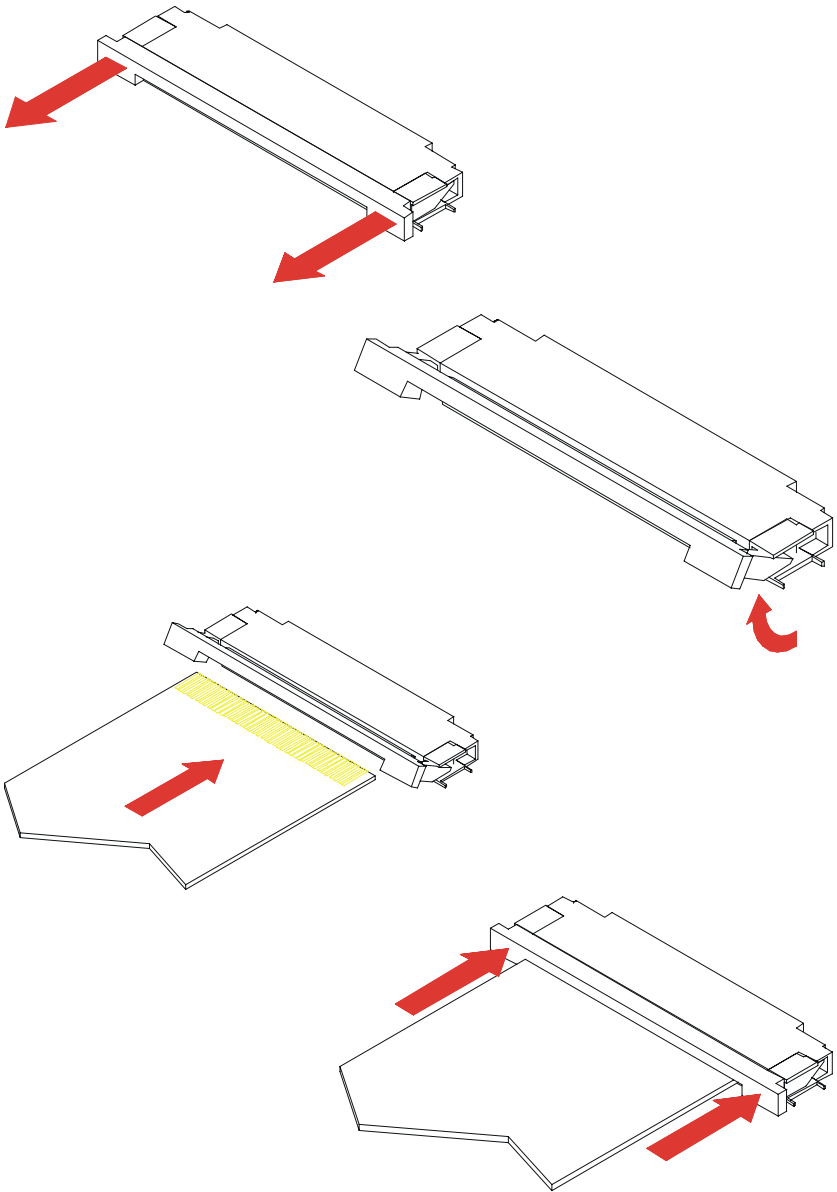

Figure 1-3: Installation of FPC cable

CHAPTER
2

Connecting Peripherals

This chapter tells how to set up the CPC-2420's hardware, including connecting peripherals, switches and indicators.

2.1 Board layout: connector locations

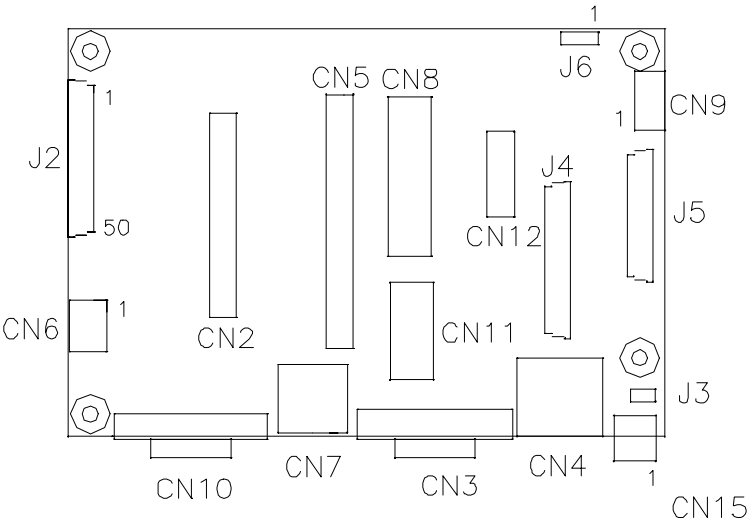

Figure 2-1: Board layout: connector locations (component side)

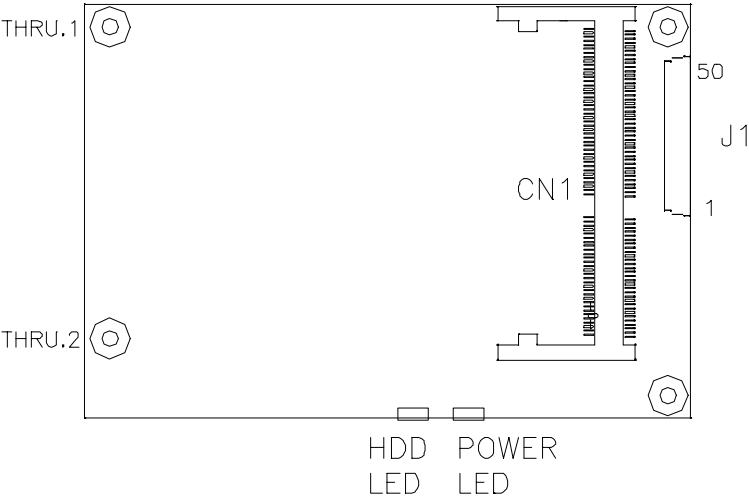

Figure 2-2: Board layout: connector locations (solder side)

The following table lists the connectors on the CPC-2420.

Table 2-1: Connectors

Number	Function
CN1	SODIMM socket
CN2	FDD/LPT connector
CN3	VGA connector
CN4	Ethernet connector
CN5	IDE connector
CN6	Power connector
CN7	Keyboard and PS/2 mouse connector
CN8	LCD 24-bit connector
CN9	LCD inverter connector
CN10	COM1 RS-232 connector
CN11	LCD 36-bit connector
CN12	COM2 RS-232 connector
CN15	Phoenix power connector
J1	ISA slot connector
J2	ISA slot connector
J4	LCD FPC connector
J5	VGA/COM/KB/MS FPC connector

2.2 Floppy drive/parallel port connector (CN2)

You can attach up to two floppy disk drives to the CPC-2420's onboard connector. You can use any combination of 5.25" (360 KB / 1.2 MB) and/or 3.5" (720 KB / 1.44 / 2.88 MB) drives.

The board comes with a 34-pin daisy-chain drive connector cable. One end of the cable has a 34-pin flat-cable connector. The other end has two sets of floppy disk drive connectors. Each set consists of a 34-pin flat-cable connector (usually used for 3.5" drives) and a printed-circuit-board connector (usually used for 5.25" drives). You can use only one connector in each set. The set on the end (after the twist in the cable) connects to the A: floppy. The set in the middle connects to the B: floppy.

The parallel port is normally used to connect the CPU card to a printer. The CPC-2420 has a parallel port cable, accessed via connector CN2. The parallel port is designated as LPT1, and can be disabled.

Note that an FDD cannot operate simultaneously with the parallel port.

2.4 VGA display connector (CN3)

The CPC-2420 provides a VGA controller for a high resolution VGA interface. The CPC-2420's CN3 is a DB-15 connector for VGA monitor input. Pin assignments for the CRT display are detailed in Appendix A.

Note that the VGA connector only operates when Advantech's CPC-2520 is not present in the system.

2.5 Ethernet configuration (CN4)

The CPC-2420 is equipped with a high performance 32-bit PCI-bus Fast Ethernet interface which is fully compliant with IEEE 802.3u 100/10Base-T specifications. It is supported by all major network operating systems.

2.6 Enhanced IDE connector (CN5)

You can attach two IDE (Integrated Device Electronics) drives to the CPC-2420. The CPC-2420 has an EIDE connector, designated CN5. Wire number 1 on the cable is red or blue, and the other wires are gray. Connect one end to connector CN5 on the carrier board. Make sure that the red (or blue) wire corresponds to pin 1 on the connector (on the right side). See "Board layout: connector locations" earlier in this chapter for help in finding the connector.

Unlike floppy drives, IDE hard drives can connect in either position on the cable. If you install two drives, you will need to set one as the master and one as the slave. You do this by setting the jumpers on the drives. If you use just one drive, you should set it as the master. See the documentation that came with your drive for more information. Connect the first hard drive to the other end of the cable. Wire 1 on the cable should also connect to pin 1 on the hard drive connector, which is labeled on the drive circuit board. Check the documentation that came with the drive for more information.

Connect the second drive, as described above, to CN5.

2.7 Power connector (CN6/CN15)

The CPC-2420's 5-pin power connector (CN6) is a 2.0 mm pitch mini-connector which carries 5 V DC and 12 V DC. An attached cable is used to transfer this mini-connector to the standard PC's AT power connector. Users can easily purchase AT power supplies in the marketplace.

The CPC-2420 comes with a Phoenix connector which carries 5 V DC for external power input. The CPC-2420 can get power either from CN6 or CN15.

2.8 Keyboard and PS/2 mouse connector (CN7)

The CPC-2420 board provides a keyboard connector. A 6-pin mini-DIN connector (CN7) is located on the board mounting bracket. The board comes with an adapter to convert from the 6-pin mini-DIN connector to a standard DIN connector and to a PS/2 mouse connector.

2.9 24-bit LCD display connector (CN8)

CN8 is a 40-pin dual inline header, and is used to connect an LCD display to the CPC-2420. The CPC-2420 has bias control which can be used to control the LCD signal voltage. Pin 7 of CN8 is for LCD contrast adjustments.

2.10 LCD inverter connector (CN9)

The LCD inverter is connected to CN9 via a 5-pin connector, to provide +12 V power to the LCD display. Pin 4 of CN9 provides LCD brightness control, and can be adjusted via R6 or R7.

2.11 Serial ports (CN10: COM1/RS-232; CN12: COM2/RS-232)

The CPC-2420 offers two serial ports: COM1 (RS-232) and COM2 (RS-232). These ports allow you to connect to serial devices (a mouse, printers, etc.) or a communications network.

You can select the address for each port (for example, 3F8H [COM1], 2F8H [COM2]), or disable each port..

2.11.1 RS-232 connection (COM1: CN10)

Different devices implement the RS-232 standard in different ways. If you are having problems with a serial device, be sure to check the pin assignments for the connector.

2.11.2 RS-232 connection (COM2: CN12)

COM2 is an RS-232 serial port. The IRQ and address range are both fixed. However, if you wish to disable the port or change these parameters later, you can do this in the system BIOS setup. The table below shows the settings for the CPC-2420 board's ports:

Table 2-2: CPC-2420 serial port default settings

Port	Address	Interrupt	Default
COM1	3F8, 3E8	IRQ4	3F8
COM2	2F8, 2E8	IRQ3	2F8

2.12 36-bit LCD display connector (CN11)

The CPC-2420 supports a 36-bit LCD, which must be connected to both CN8 (40-pin) and CN11 (20-pin).

The pin assignments for both CN8 and CN11 can be found in Appendix A.

2.13 ISA connector (J1/J2)

A 16-bit ISA-bus is used to connect the CPC-2420 to a customized I/O expansion card.

Pin Assignments

- Floppy drive/parallel port connector
- CRT display connector
- IDE hard drive connector
- Power connector
- Keyboard and mouse connector
- 24-bit LCD display connector
- LCD power inverter
- COM1 RS-232 serial port
- 36-bit LCD display connector
- COM2 RS-232 serial port
- Phoenix power connector
- ISA-bus FPC connector
- Board layout: locations of Pin 1 of J1 and J2
- FPC cable layout: (J1/J2; 50-pin FPC connector)

A.1 Floppy drive/parallel port connector (CN2)

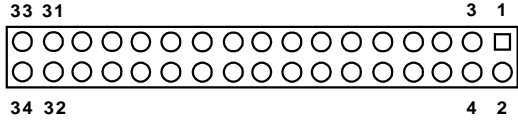

Table A-1: Parallel port connector (CN2)

Pin	Parallel port signal	Pin	Parallel port signal
1	GND	2	AUTOFD
3	GND	4	D5
5	GND	6	\STROBE
7	GND	8	D0
9	GND	10	D6
11	GND	12	\ACK
13	GND	14	D7
15	GND	16	BUSY
17	GND	18	INIT
19	GND	20	SLIN
21	GND	22	PE
23	GND	24	SLCT
25	GND	26	D1
27	GND	28	D2
29	GND	30	D3
31	GND	32	ERR
33	GND	34	D4

Table A-2: Floppy drive connector (CN2)

Pin	Floppy signal	Pin	Floppy signal
1	GND	2	DENSITY SELECT*
3	GND	4	N/C
5	GND	6	N/C
7	GND	8	INDEX*
9	GND	10	MOTOR 0*
11	GND	12	DRIVE SELECT 1*
13	GND	14	DRIVE SELECT 0*
15	GND	16	MOTOR 1*
17	GND	18	DIRECTION*
19	GND	20	STEP*
21	GND	22	WRITE DATA*
23	GND	24	WRITE GATE*
25	GND	26	TRACK 0*
27	GND	28	WRITE PROTECT*
29	GND	30	READ DATA*
31	GND	32	HEAD SELECT*
33	GND	34	DISK CHANGE*

* low active

A.2 CRT display connector (CN3)

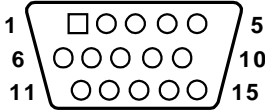

Table A-3: CRT display connector (CN3)

Pin	Signal	Pin	Signal
1	RED	9	N/C
2	GREEN	10	GND
3	BLUE	11	N/C
4	N/C	12	N/C
5	GND	13	H-SYNC
6	GND	14	V-SYNC
7	GND	15	N/C
8	GND		

A.3 IDE hard drive connector (CN5)

Table A-4: IDE hard drive connector (CN5)

Pin	Signal	Pin	Signal
1	IDE RESET*	2	GND
3	DATA 7	4	DATA 8
5	DATA 6	6	DATA 9
7	DATA 5	8	DATA 10
9	DATA 4	10	DATA 11
11	DATA 3	12	DATA 12
13	DATA 2	14	DATA 13
15	DATA 1	16	DATA 14
17	DATA 0	18	DATA 15
19	SIGNAL GND	20	N/C
21	N/C	22	GND
23	IO WRITE	24	GND
25	IO READ	26	GND
27	IO CHANNEL READY	28	N/C
29	HDACKO*	30	GND
31	IRQ14	32	IOCS16
33	ADDR 1	34	N/C
35	ADDR 0	36	ADDR 2
37	HARD DISK SELECT 0*	38	HARD DISK SELECT 1*
39	IDE ACTIVE*	40	GND

* low active

A.4 Power connector (CN6)

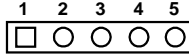

Table A-5: Power connector (CN6)

Pin	Signal
1	+5 V
2	+5 V
3	GND
4	GND
5	+12 V

Note: The model number of CN6 is B5B-PH-K-S (JST Co.)

A.5 Keyboard and mouse connector (CN7)

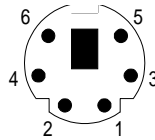

Table A-6: Keyboard and mouse connector (CN7)

Pin	Signal
1	KB DATA
2	MS DATA
3	GND
4	V_{cc}
5	KB CLOCK
6	MS CLOCK

A.6 24-bit LCD display connector (CN8)

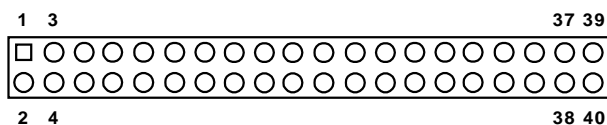

Table A-7: 24-bit LCD display connector (CN8)

Pin	Signal	Pin	Signal
1	VDDSAFE5/ VDDSAFE3	2	VDDSAFE5/ VDDSAFE3 (Note2)
3	GND	4	GND
5	VDDSAFE3	6	VDDSAFE3
7	Vcon	8	GND
9	P0	10	P1
11	P2	12	P3
13	P4	14	P5
15	P6	16	P7
17	P8	18	P9
19	P10	20	P11
21	P12	22	P13
23	P14	24	P15
25	P16	26	P17
27	P18	28	P19
29	P20	30	P21
31	P22	32	P23
33	GND	34	GND
35	SHIFT CLOCK	36	FILM
37	M	38	LP
39	ENABKL	40	ENAVEE

Note 1: The model number of the CN8 socket is DF13A-40DP-1.25V (Hirose Electric Co., Ltd.)

Note 2: 3.3 V or 5 V V_{DD} could be selected by using J6.

A.7 LCD power inverter (CN9)

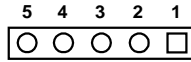

Table A-8: LCD power inverter (CN9)

Pin	Signal
1	+12 V
2	GND
3	ENABKL
4	VBR
5	V_{CC}

A.8 COM1 RS-232 serial port (CN10)

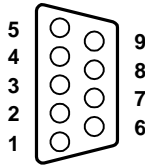

Table A-9: COM1 RS-232 serial port (CN10)

Pin	Signal
1	DCD
2	RXD
3	TXD
4	DTR
5	GND
6	DSR
7	RTS
8	CTS
9	RI

A.9 36-bit LCD display connector (CN11)

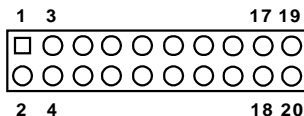

Table A-10: 36-bit LCD display connector (CN11)

Pin	Signal	Pin	Signal
1	GND	2	GND
3	P24	4	P25
5	P26	6	P27
7	P28	8	P29
9	P30	10	P31
11	P32	12	P33
13	P34	14	P35
15	GND	16	GND
17	NC	18	N/C
19	N/C	20	N/C

Note: *The model number of the CN11 socket is DF13A-20DP-1.25V (Hirose Electric Co., Ltd.)*

A.10 COM2 RS-232 serial port (CN12)

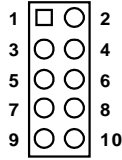

Table A-11: COM2 RS-232 serial port (CN12)

Pin	RS-232 port	Pin	RS-232 port
1	DCD	6	CTS
2	DSR	7	DTR
3	RxD	8	RI
4	RTS	9	GND
5	TxD	10	N/C

A.11 Phoenix power connector (CN15)

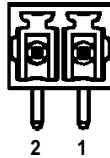

Table A-12: Phoenix power connector (CN15)

Pin	Signal
1	GND
2	+5 V

A.12 ISA-bus FPC connector (J1/J2)

Table A-13: ISA- bus FPC connector (J1)

Pin	Signal	Pin	Signal
1	GND	26	SA2
2	ZW	27	SA6
3	SA18	28	SD8
4	SA19	29	SD10
5	TC	30	SD11
6	IRQ6	31	SD9
7	IRQ5	32	SD14
8	IRQ4	33	SD13
9	SA10	34	SD12
10	SA9	35	BALE
11	SA14	36	SD15
12	SA17	37	SMEMR
13	SA12	38	SBHE
14	IRQ12	39	MEMR
15	GND	40	IOCS16
16	SYSCLK	41	IOCHK
17	GND	42	REFRESH
18	DRQ3	43	GND
19	DRQ1	44	GND
20	DRQ0	45	GND
21	LA17	46	GND
22	LA19	47	GND
23	LA22	48	GND
24	SA0	49	GND
25	LA23	50	GND

Table A-14: ISA-bus FPC connector (J2)

Pin	Signal	Pin	Signal
1	GND	26	DRQ7
2	RSTDRV	27	LA20
3	IRQ3	28	LA18
4	DACK7	29	LA21
5	DACK6	30	SA1
6	DACK5	31	SA4
7	NC	32	SA3
8	DACK3	33	SA7
9	DACK2	34	SA5
10	DACK1	35	SD0
11	DACK0	36	SD2
12	IRQ7	37	SD3
13	IRQ9	38	SD4
14	IRQ10	39	SD1
15	IRQ11	40	SD6
16	SA11	41	SD7
17	SA8	42	SD5
18	SA13	43	IOCHRDY
19	SA16	44	MEMW
20	SA15	45	IOR
21	IRQ15	46	MASTER
22	IRQ14	47	SMEMW
23	DRQ2	48	MEMCS16
24	DRQ5	49	IOW
25	DRQ6	50	AEN

A.13 Board layout: locations of Pin 1 of J1 and J2

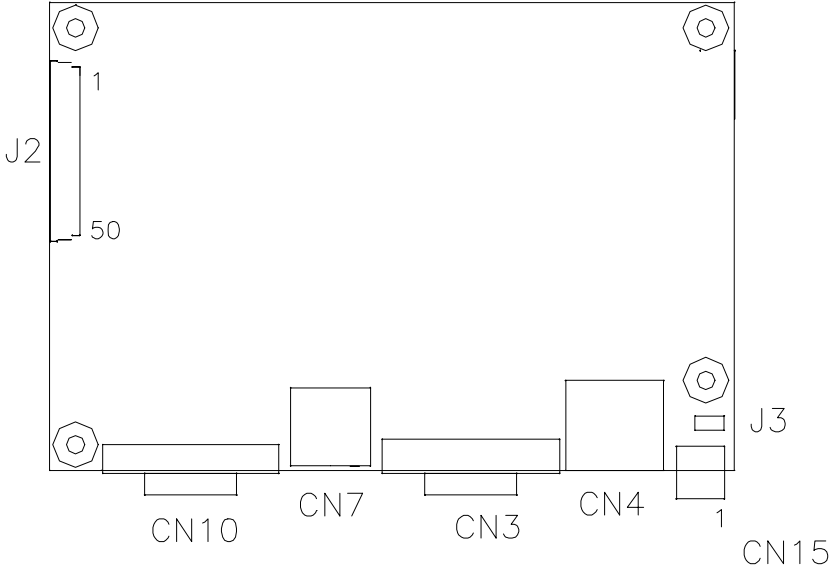

Figure A-1: Board layout: location of Pin 1 of J2 (component side)

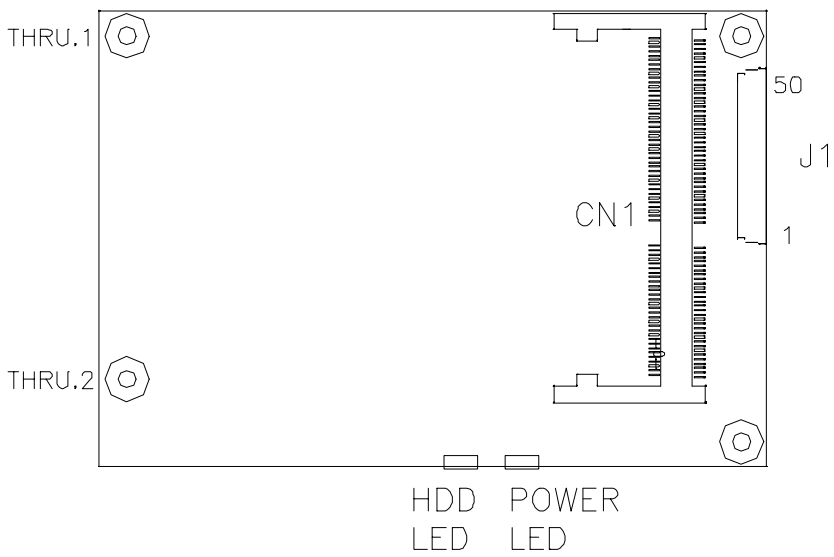

Figure A-2: Board layout: location of Pin 1 of J1 (solder side)

A.14 FPC cable layout (J1/J2; 50-pin FPC connector)

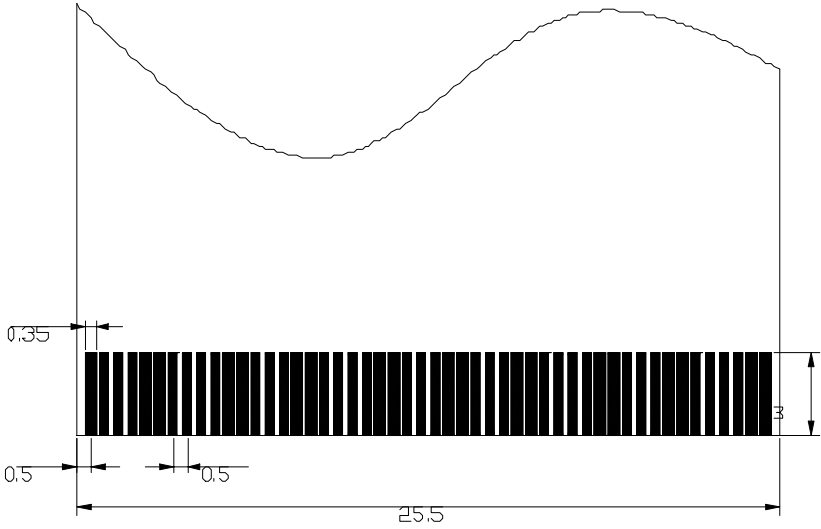

Figure A-3: FPC cable layout

