



User Manual

ARK-VH200

Embedded IPC

Trusted ePlatform Services

ADVANTECH

Attention!

Please note:

This package contains a hard-copy user manual in Chinese for China CCC certification purposes, and there is an English user manual included as a PDF file on the CD. Please disregard the Chinese hard copy user manual if the product is not to be sold and/or installed in China.

Copyright

The documentation and the software included with this product are copyrighted 2010 by Advantech Co., Ltd. All rights are reserved. Advantech Co., Ltd. reserves the right to make improvements in the products described in this manual at any time without notice.

No part of this manual may be reproduced, copied, translated or transmitted in any form or by any means without the prior written permission of Advantech Co., Ltd. Information provided in this manual is intended to be accurate and reliable. However, Advantech Co., Ltd. assumes no responsibility for its use, nor for any infringements of the rights of third parties, which may result from its use.

Acknowledgements

Award is a trademark of Award Software International, Inc.

VIA is a trademark of VIA Technologies, Inc.

IBM, PC/AT, PS/2 and VGA are trademarks of International Business Machines Corporation.

Intel® and Pentium® are trademarks of Intel Corporation.

Microsoft Windows® is a registered trademark of Microsoft Corp.

RTL is a trademark of Realtek Semi-Conductor Co., Ltd.

ESS is a trademark of ESS Technology, Inc.

UMC is a trademark of United Microelectronics Corporation.

SMI is a trademark of Silicon Motion, Inc.

Creative is a trademark of Creative Technology LTD.

CHRONTEL is a trademark of Chrontel Inc.

All other product names or trademarks are properties of their respective owners.

For more information about this and other Advantech products, please visit our website at:

<http://www.advantech.com/>

<http://www.advantech.com/ePlatform/>

For technical support and service, please visit our support website at:

<http://support.advantech.com.tw/support/>

Product Warranty (2 years)

Advantech warrants to you, the original purchaser, that each of its products will be free from defects in materials and workmanship for two years from the date of purchase.

This warranty does not apply to any products which have been repaired or altered by persons other than repair personnel authorized by Advantech, or which have been subject to misuse, abuse, accident or improper installation. Advantech assumes no liability under the terms of this warranty as a consequence of such events.

Because of Advantech's high quality-control standards and rigorous testing, most of our customers never need to use our repair service. If an Advantech product is defective, it will be repaired or replaced at no charge during the warranty period. For out-of-warranty repairs, you will be billed according to the cost of replacement materials, service time and freight. Please consult your dealer for more details.

If you think you have a defective product, follow these steps:

1. Collect all the information about the problem encountered. (For example, CPU speed, Advantech products used, other hardware and software used, etc.) Note anything abnormal and list any onscreen messages you get when the problem occurs.
2. Call your dealer and describe the problem. Please have your manual, product, and any helpful information readily available.
3. If your product is diagnosed as defective, obtain an RMA (return merchandise authorization) number from your dealer. This allows us to process your return more quickly.
4. Carefully pack the defective product, a fully-completed Repair and Replacement Order Card and a photocopy proof of purchase date (such as your sales receipt) in a shippable container. A product returned without proof of the purchase date is not eligible for warranty service.
5. Write the RMA number visibly on the outside of the package and ship it prepaid to your dealer.

Declaration of Conformity

FCC Class A

Note: This equipment has been tested and found to comply with the limits for a Class A digital device, pursuant to part 15 of the FCC Rules. These limits are designed to provide reasonable protection against harmful interference when the equipment is operated in a commercial environment. This equipment generates, uses, and can radiate radio frequency energy and, if not installed and used in accordance with the instruction manual, may cause harmful interference to radio communications. Operation of this equipment in a residential area is likely to cause harmful interference in which case the user will be required to correct the interference at his own expense.

Technical Support and Assistance

1. Visit the Advantech web site at www.advantech.com/support where you can find the latest information about the product.
2. Contact your distributor, sales representative, or Advantech's customer service center for technical support if you need additional assistance. Please have the following information ready before you call:
 - Product name and serial number
 - Description of your peripheral attachments
 - Description of your software (operating system, version, application software, etc.)
 - A complete description of the problem
 - The exact wording of any error messages

Warnings, Cautions and Notes

Warning! *Warnings indicate conditions, which if not observed, can cause personal injury!*



Caution! *Cautions are included to help you avoid damaging hardware or losing data. e.g.*



There is a danger of a new battery exploding if it is incorrectly installed. Do not attempt to recharge, force open, or heat the battery. Replace the battery only with the same or equivalent type recommended by the manufacturer. Discard used batteries according to the manufacturer's instructions.

Note! *Notes provide optional additional information.*



Safety Instructions

1. Please read these safety instructions carefully.
2. Please keep this User's Manual for later reference.
3. Please disconnect this equipment from AC outlet before cleaning. Use a damp cloth. Don't use liquid or sprayed detergent for cleaning. Use moist sheet or cloth for cleaning.
4. For pluggable equipment, the socket-outlet shall near the equipment and shall be easily accessible.
5. Please keep this equipment from humidity.
6. Lay this equipment on a reliable surface when install. A drop or fall could cause injury.
7. The openings on the enclosure are for air convection hence protecting the equipment from overheating. **DO NOT COVER THE OPENINGS.**
8. Make sure the voltage of the power source when connecting the equipment to the power outlet.
9. Place the power cord such a way that people cannot step on it. Do not place anything over the power cord.
10. All cautions and warnings on the equipment should be noted.
11. If the equipment is not used for long time, disconnect the equipment from mains to avoid being damaged by transient over-voltage.
12. Never pour any liquid into ventilation openings; this could cause fire or electrical shock.
13. Never open the equipment. For safety reasons, only qualified service personnel should open the equipment.
14. If one of the following situations arises, get the equipment checked by service personnel:
 - The power cord or plug is damaged.
 - Liquid has penetrated into the equipment.
 - The equipment has been exposed to moisture.
 - The equipment does not work well, or you cannot get it to work according to the user's manual.
 - The equipment has been dropped and damaged.
 - The equipment has obvious signs of breakage.
15. **DO NOT LEAVE THIS EQUIPMENT IN AN ENVIRONMENT WHERE THE STORAGE TEMPERATURE MAY GO BELOW -40° C (-40° F) OR ABOVE 85° C (185° F). THIS COULD DAMAGE THE EQUIPMENT. THE EQUIPMENT SHOULD BE IN A CONTROLLED ENVIRONMENT.**
16. **CAUTION: DANGER OF EXPLOSION IF BATTERY IS INCORRECTLY REPLACED. REPLACE ONLY WITH THE SAME OR EQUIVALENT TYPE RECOMMENDED BY THE MANUFACTURER, DISCARD USED BATTERIES ACCORDING TO THE MANUFACTURER'S INSTRUCTIONS.**
17. The sound pressure level at the operator's position according to IEC 704-1:1982 is no more than 70 dB (A).
18. **RESTRICTED ACCESS AREA:** The equipment should only be installed in a Restricted Access Area.
19. **DISCLAIMER:** This set of instructions is given according to IEC 704-1. Advantech disclaims all responsibility for the accuracy of any statements contained herein.

Packing List

Before installation, please ensure the following items have been shipped:

- 1 x ARK-VH200 Unit
- 1 x Driver/Utility CD
- 1 x Registration and 2 years Warranty card
- 1 x 3P Phoenix Power PLUG-IN BLOCK 5.0mm

Ordering information

Model Number	Description
ARK-VH200A-D5A1E	Intel Atom D510 1.66 GHz Compact Embedded Box IPC for Vehicle application, w/ vehicle power, ignition, 4-CH video recorder
ARK-VH200B-D5A1E	Intel Atom D510 1.66 GHz Compact Embedded Box IPC for Vehicle application, w/ vehicle power, ignition, 1xPoE

Optional accessories

Part Number	Description
1757002682	AC-to-DC Adapter DC19 V/3.42 A 65 W, 0 ~ 40°C for Home and Office Use
1652004519	3P Phoenix Power PLUG-IN BLOCK 5.0mm
1700001524	Power Cable 3-pin 180 cm, USA Type
170203183C	Power Cable 3-pin 180 cm, Europe Type
170203180A	Power Cable 3-pin 180 cm, UK Type
1700008921	Power Cable 3-pin 180 cm, PSE Mark

Contents

Chapter 1	General Introduction	1
1.1	Introduction	2
1.2	Product Features.....	2
1.2.1	General	2
1.2.2	Display	3
1.2.3	Ethernet	3
1.2.4	Power.....	3
1.2.5	Video Recording (ARK-VH200A only)	3
1.3	Chipset.....	4
1.3.1	Functional Specifications	4
1.4	Mechanical Specifications.....	6
1.4.1	Dimensions	6
	Figure 1.1 ARK-VH200 Mechanical dimension drawing.....	6
1.4.2	Weight.....	6
1.5	Power Requirements.....	6
1.5.1	System Power.....	6
1.5.2	RTC Battery	6
1.6	Environmental Specifications	7
1.6.1	Operating Temperature.....	7
1.6.2	Relative Humidity	7
1.6.3	Storage Temperature.....	7
1.6.4	Vibration During Operation	7
1.6.5	Shock During Operation.....	7
1.6.6	Safety.....	7
1.6.7	EMC	7
1.6.8	Vehicle Certifications	7
Chapter 2	H/W Installation.....	9
2.1	Introduction	10
2.2	Jumpers	10
2.2.1	Jumper Description	10
2.2.2	Jumper List	11
	Table 2.1: Jumper List for Motherboard	11
	Table 2.2: Jumper List for MIO Board	11
2.2.3	Jumper Locations.....	11
	Figure 2.1 Jumper and connector layout (Motherboard)	11
	Figure 2.2 Jumper layout (MIO Board)	12
2.2.4	Jumper Setting.....	12
2.3	Connectors.....	15
2.3.1	ARK-VH200 External I/O Connectors	15
	Figure 2.3 Front panel of ARK-VH200.....	15
	Figure 2.4 Rear panel of ARK-VH200	15
	Figure 2.5 COM Port connector.....	16
	Table 2.3: COM Connector Pin Assignments.....	16
	Figure 2.6 Ethernet connector	16
	Table 2.4: Ethernet Connector Pin Assignments.....	16
	Figure 2.7 Audio connector.....	17
	Table 2.5: Audio Connector Pin Assignments	17
	Figure 2.8 DIO Connector.....	17
	Table 2.6: DIO Connector Pin Assignments.....	17
	Figure 2.9 USB connector	18
	Table 2.7: USB Connector.....	18
	Figure 2.10VGA Connector	18

	Table 2.8: VGA Connector Pin Assignments	18
	Figure 2.11 Power Input Connector.....	19
	Table 2.9: Power connector Pin Assignments.....	19
	Figure 2.12 Power Button.....	19
	Figure 2.13 LED Indicators.....	19
	Figure 2.14 Power Output Connector.....	19
	Table 2.10: Power Output Connector Pin Assignments	20
	Figure 2.15 eSATA/USB Connector	20
	Table 2.11: eSATA Connector Pin Assignments.....	20
	Figure 2.16 LVDS Connector	20
	Table 2.12: LVDS Connector Pin Assignment	21
2.4	Installation.....	22
2.4.1	HDD Installation.....	22
	Figure 2.17 Unscrew the HDD door screws	22
	Figure 2.18 Assemble HDD and HDD frame with 4 screws	22
	Figure 2.19 Use the HDD damper screws to assemble the HDD door and HDD frame	23
	Figure 2.20 Connect the HDD cables.....	23
2.4.2	Memory Installation.....	24
	Figure 2.21 Install the memory module into the SO-DIMM socket at the bottom of the Main board	24
2.4.3	CF Card Installation	24
	Figure 2.22 Unscrew the CF door screws	24
	Figure 2.23 Pull the CF tray out.....	25
	Figure 2.24 Remove CF bracket	25
	Figure 2.25 Put CF onto the CF tray	26
2.4.4	Wireless Module Installation	26
	Figure 2.26 Unscrew the top case screws.....	26
	Figure 2.27 Knock out ANT hole and screw the SMA Cable into the front panel	27
	Figure 2.28 Put the SIM card into the socket	27
	Figure 2.29 Insert the miniPCIe card module	28
	Figure 2.30 Connect the SMA Cable to the miniPCIe card module	28

Chapter 3 BIOS Settings 29

	Figure 3.1 Setup Program Initial Screen	30
3.1	Entering BIOS Setup.....	30
3.2	Main Menu	31
	Figure 3.2 Main Setup Screen.....	31
3.2.1	System Time / System Date	31
3.3	Advanced BIOS Features Setup.....	31
	Figure 3.3 Advanced BIOS Features Setup Screen.....	32
3.3.1	CPU Configuration.....	32
	Figure 3.4 CPU Configuration Setting	32
3.3.2	IDE Configuration	33
	Figure 3.5 IDE Configuration	33
3.3.3	Super I/O Configuration	34
	Figure 3.6 Super I/O Configuration.....	34
3.3.4	Hardware Health Configuration	35
	Figure 3.7 Hardware Health Configuration	35
3.3.5	ACPI Settings	35
	Figure 3.8 ACPI Setting.....	35
	Figure 3.9 General ACPI Configuration.....	36
	Figure 3.10 Advanced ACPI Configuration.....	36
	Figure 3.11 Chipset ACPI Configuration	37
3.3.6	AHCI Setting	38
	Figure 3.12 AHCI Setting.....	38

3.3.7	APM Configuration	38
	Figure 3.13 APM Configuration	38
3.3.8	Event Log Configuration	39
	Figure 3.14 Event Log Configuration	39
3.3.9	MPS Configuration	40
	Figure 3.15 MPS Configuration	40
3.3.10	Smbios Configuration	41
	Figure 3.16 Smbios Configuration	41
3.3.11	USB Configuration	41
	Figure 3.17 USB Configuration	41
	Figure 3.18 USB Mass storage Device Configuration	42
3.4	Advanced PCI/PnP Settings	43
	Figure 3.19 PCI/PNP Setup (top)	43
3.5	Boot Settings	44
	Figure 3.20 Boot Setup Utility	44
3.5.1	Boot Settings Configuration	45
	Figure 3.21 Boot Setting Configuration	45
3.6	Security Setup	46
	Figure 3.22 Password Configuration	46
3.7	Advanced Chipset Settings	47
	Figure 3.23 Advanced Chipset Settings	47
3.7.1	North Bridge Chipset Configuration	47
	Figure 3.24 North Bridge Configuration	47
	Figure 3.25 Video function configuration	48
3.7.2	South Bridge Chipset Configuration	49
	Figure 3.26 South Bridge Configuration	49
3.8	Exit OS	50
	Figure 3.27 Exit Option	50
3.8.1	Save Changes and Exit	50
3.8.2	Discard Changes and Exit	50
3.8.3	Load Optimal Defaults	50
3.8.4	Load Fail-Safe Defaults	50

Chapter 1

General Introduction

This chapter gives background information on ARK-VH200 series.

1.1 Introduction

The ARK-VH200 fanless Embedded Industrial Computer is an ideal, application-ready system platform solution for in-vehicle applications. All electronics are protected in a compact, sealed, aluminum case for easy embedding in the customer's own housing, or as a stand-alone application where space is limited and the environment harsh.

A solid sealed aluminum case provides vibration and dust resistance while also providing a passive cooling solution. The ARK-VH200 provides system integrators with a turn-key solution and versatile application development path without breaking the bank or missing time-to-market deadlines.

The ARK-VH200 can be used as a standalone system in vehicles, and occupies a footprint of only 260 x 134 x 77 mm. The rugged, cast aluminum case not only provides great protection from EMI, shock/vibration, cold and heat, but, as we mentioned before, passive cooling for quiet, fanless operation. Its particular power design accepts a wide range of DC power that is compliant with vehicle power. ARK-VH200 is able to power ON/OFF with the ignition status of vehicles through the ignition pin. The firmware in ARK-VH200 is designed for controlling turn-on delay, turn-off delay and hard off, which ensures the system works dependably even in the vehicular electrical environment.

The ARK-VH200 answers offers up to 1 x VGA, 5 x USB 2.0 ports, 3 x Giga LAN ports, 3 x COM ports, 1 x eSATA, on board GPS, and 4-bit GPIO. Besides, ARK-VH200 can also support either 4 channel video recorders with H.264 hardware decoding or one PoE interface. The ARK-VH200 Compact Embedded Computer supports both 2.5" SATA HDD and Compact Flash card for storage options; it provides not only for in-vehicle use, but also for diversified applications in other fields.

1.2 Product Features

1.2.1 General

- **CPU:** Intel® Atom™ Processor D510 1.6 GHz
- **System Chipset:** Intel® ICH8M
- **BIOS:** AMI 16 Mbit Flash BIOS
- **System Memory:** DDRII 667 MHz up to 2 GB
- **SSD:** Supports CompactFlash Card TYPE I/II
- **Watchdog Timer:** Single chip Watchdog 255-level interval timer, setup by software
- **I/O Interface:** 3 x RS232
- **USB:** 5 x USB 2.0 (one shared with e-SATA connector), Compliant with USB 2.0, two ports with lock
- **Audio:** Line out, Mic-in
- **DIO:** 4-bit general purpose input/output
- **Expansion Interface:** Supports 2 x Mini-PCIe device
- **eSATA:** Supports 1 x eSATA (not support hot plug)
- **GPS:** Built-in u-blox LEA 5 GPS GPS/GALILEO chip (Communication via COM4)
- **Video Recording:** Supports 4 x CH Video and Audio input with HW coding.

1.2.2 Display

- **Chipset:** Intel® Embedded Gen3.5+ GFX Core
- **Memory Size:** Up to 224 MB of dynamic video memory allocation
- **Interface:**
 - CRT x 1
 - LVDS: Supports 18-bit LVDS LCD
- **Resolution:**
 - CRT: to 2048 x 1536 (CRT single display)
 - LVDS: Single channel 18-bit LVDS up to WXGA 1366 x 768
- **Dual Display:**
 - CRT + LVDS (18-bit)

1.2.3 Ethernet

- **Chipset:** LAN1 Intel 82567, LAN2 Intel 82583V, PoE Intel 82574L (ARK-VH200B only)
- **Speed:** 10/100/1000 Mbps
- **Interface:** 3 x RJ45
- **Standard:** Compliant with IEEE 802.3, IEEE 802.3u, IEEE 802.3x, IEEE 802.3y, IEEE 802.ab.
- **Power over Ethernet:** Compliant with IEEE802.3 af, up to 15 Watt (ARK-VH200B only)

1.2.4 Power

- **Input Voltage:** $9 V_{DC} \sim 32 V_{DC}$
- **Ignition:** Support ignition function
- **In-Vehicle Function:** Battery status check, and Off-delay support
- **In-Vehicle Certificate:** Compliant with ISO-7637-2
- **Input Connector Interface:** 3-pin phoenix connector (pitch 5.0mm)
- **Power Output:** $12V_{DC}$ maximum 1A and 5VDC maximum 1A

1.2.5 Video Recording (ARK-VH200A only)

- **Video Compression:** H/W H.264
- **Video Input:** 4 x Ch Video Inputs, BNC
- **Audio Input:** 4 x Ch Audio Inputs, D-SUB9 (Optional)
- **Video Format:** CIF, 2CIF, D1
- **Video Frame:** 30/25 FPS (NTSC/PAL) @ D1 resolution
- **Watchdog Timer:** Yes
- **SDK Support:** VC++, .NET/BCB/VB

1.3 Chipset

1.3.1 Functional Specifications

1.3.1.1 Processor

Processor	Intel® Atom™ D510 at 1.67 GHz with 1MB L2 cache Manufacturing Technology: 45 nm
------------------	--

1.3.1.2 Chipset

Memory	<ul style="list-style-type: none">■ Intel® D510■ Supports DDR2 667 MHz up to 2 GB■ SODIMM Socket:<ul style="list-style-type: none">– 1* 200-pin SODIMM socket type *1
Graphic and Video Controllers	Intel 3.5 Gen Integrated Graphic Engine + GFX core <ul style="list-style-type: none">■ DVMT 3.0 (Dynamic Video Memory Technology)■ DirectX* 9 compliant Pixel Shader 2.0■ Dual display choose on board: VGA, LVDS or VGA + LVDS through OS Driver■ Intel® Clear Video Technology■ VGA: Intel Atom D510 supports up to 2048 x 1536 (VGA single display)■ LVDS: Single channel 18-bit LVDS up to WXGA 1366 x 768 VGA Connector on board: D-SUB 15P LVDS Connector: MDR-26P
SATA & IDE Interface	SB: Intel® ICH8M chip supports: <ul style="list-style-type: none">■ Supports the Serial ATA specification Revision 1.0a■ Supports several optional sections of Serial ATA II: Extensions to Serial ATA 1.0 Specification, Revision 1.0■ Supports SATA transfers to 300 Mbytes/sec.■ Supports Compact Flash Card Type II Socket CF Socket: CF Type II 50P 90D(M) external connector x 1
USB Interface	SB: Intel® ICH8M chip supports: <ul style="list-style-type: none">■ USB host interface with support for 6 USB 2.0 ports■ All ports are High-Speed, Full-Speed, and Low-Speed capable■ Supports legacy keyboard/mouse software
Audio Link	SB: Intel® ICH8M chip supports: <ul style="list-style-type: none">■ Supports HD Codec■ Supports Link for Audio and Telephony CODECS
Power Management	SB: Intel® ICH8M chip supports: <ul style="list-style-type: none">■ Supports ACPI 2.0■ ACPI Power Management Logic Support
BIOS	SB: Intel® ICH8M chip supports: AMI 16Mb Flash BIOS via SPI

1.3.1.3 Other

LAN	<p>LAN1 Intel 82567, LAN2 Intel 82583V</p> <ul style="list-style-type: none"> ■ Compliant with IEEE 802.3, IEEE 802.3u, IEEE 802.3x, IEEE 802.3y, IEEE 802.ab. ■ Support 1000 Mbps. <p>LAN Connectors: Phone Jack RJ45 8P 90D(F)</p>
Serial ports	<p>SMSC SCH 3114 support</p> <ul style="list-style-type: none"> ■ 3 serial ports by SMSC SCH 3114. ■ High Speed NS16C550A Compatible UARTs with Data rates to 1.5Mbps. ■ Support IRQ Sharing among serial ports on XPE ■ COM1~COM3: Supports RS-232 <p>COM connector: D-SUB CON. 9P</p>
Audio	<p>Audio Codec: Realtek ALC888:</p> <ul style="list-style-type: none"> ■ Compliant with HD Audio specifications ■ Supports to 16/20/24-bit DAC and 16/20/24-bit ADC resolution ■ Support: Line-out, Mic-in <p>Audio Connectors: Ear Phone Jack * 2</p>
DIO	<p>SMSC SCH 3114 support</p> <ul style="list-style-type: none"> ■ 5 I/O pins with one ground pin ■ 5V tolerance I/Os. <p>DIO Connector: 5-pin Phoenix connector</p>
Battery backup	<ul style="list-style-type: none"> ■ BATTERY 3V/210 mAh with WIRE x 1

1.4 Mechanical Specifications

1.4.1 Dimensions

220 x 85 x 130 Unit: mm

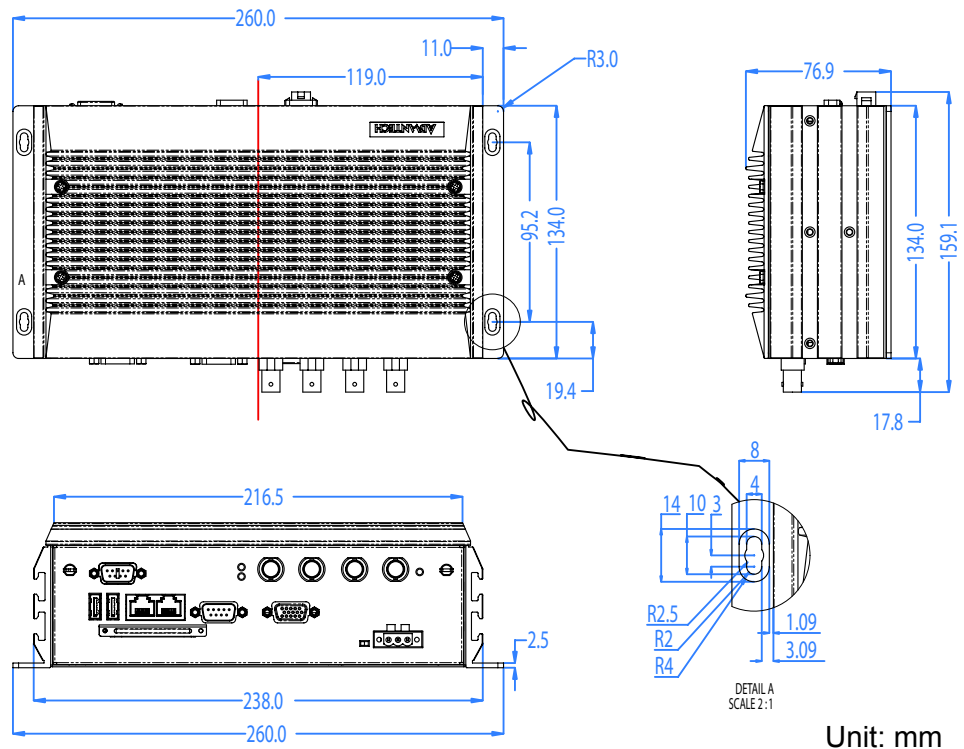

Figure 1.1 ARK-VH200 Mechanical dimension drawing

1.4.2 Weight

3 kg (6.6 lb)

1.5 Power Requirements

1.5.1 System Power

- Minimum power input: DC9V-32V 6A-1.7A

1.5.2 RTC Battery

- Lithium 3 V/210 mAH

1.6 Environmental Specifications

1.6.1 Operating Temperature

- With Industrial Grade CompactFlash disk: 0 ~ 60° C (32~131° F), when air flow speed = 0.7 m/sec
- With 2.5-inch extended temperature hard disk 0 to 45° C (32~113° F), when air flow speed = 0.7 m/sec

1.6.2 Relative Humidity

- 95% @ 40° C (non-condensing)

1.6.3 Storage Temperature

- -40 ~ 85° C (-40 ~ 185° F)

1.6.4 Vibration During Operation

- When system is equipped with Compact Flash card only: 5Grms, IEC 60068-2-64, random, 5 ~ 500 Hz, 1 Oct/min., 1hr/axis, x,y,z 3 axes.
- When system is equipped with 2.5-inch HDD: 1Grms, IEC 60068-2-64, random, 5~500 Hz, 1 Oct/min., 1hr/axis, x,y,z 3 axes.

1.6.5 Shock During Operation

- When system is equipped with Compact Flash card only: 50G, IEC 60068-2-27, half sine, 11 ms duration.
- When system is equipped with 2.5-inch: 20G, IEC 60068-2-27, half sine, 11 ms duration.

1.6.6 Safety

- CCC

1.6.7 EMC

- CE, FCC, CCC

1.6.8 Vehicle Certifications

- eMark, EN-5015

Chapter 2

H/W Installation

This chapter introduces external IO and the installation of ARK-VH200 hardware.

2.1 Introduction

The following sections show the internal jumper settings and the external connectors and pin assignments for applications.

2.2 Jumpers

2.2.1 Jumper Description

You may configure the ARK-VH200 to match the needs of your application by setting jumpers. A jumper is a metal bridge used to close an electric circuit. It consists of two metal pins and a small metal clip (often protected by a plastic cover) that slides over the pins to connect them. To close a jumper, you connect the pins with the clip. To open a jumper, you remove the clip. Sometimes a jumper will have three pins, labeled 1, 2 and 3. In this case you would connect either pins 1 and 2, or 2 and 3.

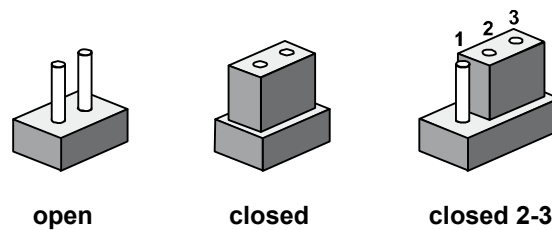

The jumper settings are schematically depicted in this manual as follows.

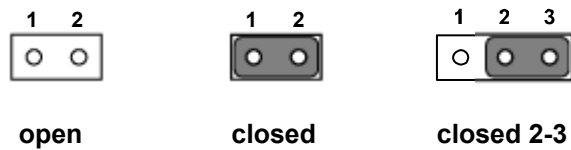

A pair of needle-nose pliers may be helpful when working with jumpers. If you have any doubts about the best hardware configuration for your application, contact your local distributor or sales representative before you make any changes. Generally, you simply need a standard cable to make most connections.

2.2.2 Jumper List

Table 2.1: Jumper List for Motherboard

J2	COM2 Setting
J4	Clear CMOS
J5	Panel Voltage Select

Table 2.2: Jumper List for MIO Board

JP2	Mini PCI-E Power Setting Header
CN2	Antenna IPEX Connector for GPS
CN3	COM for GPS

2.2.3 Jumper Locations

Motherboard

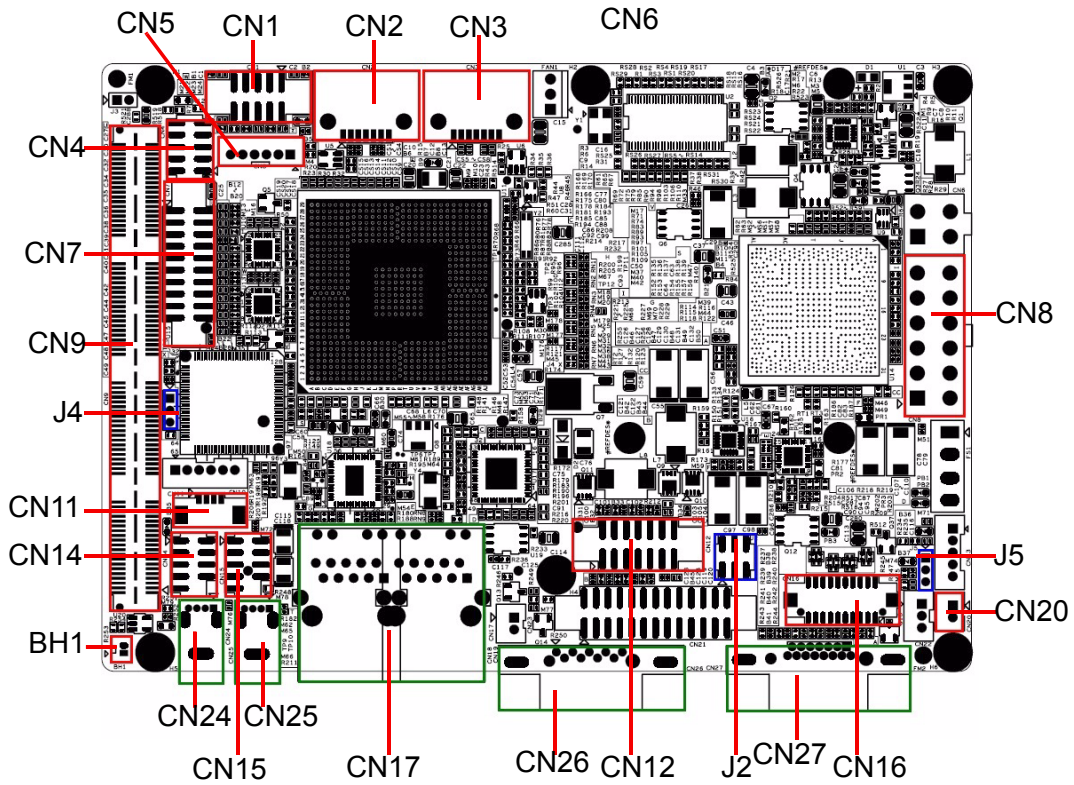

Figure 2.1 Jumper and connector layout (Motherboard)

MIO Board

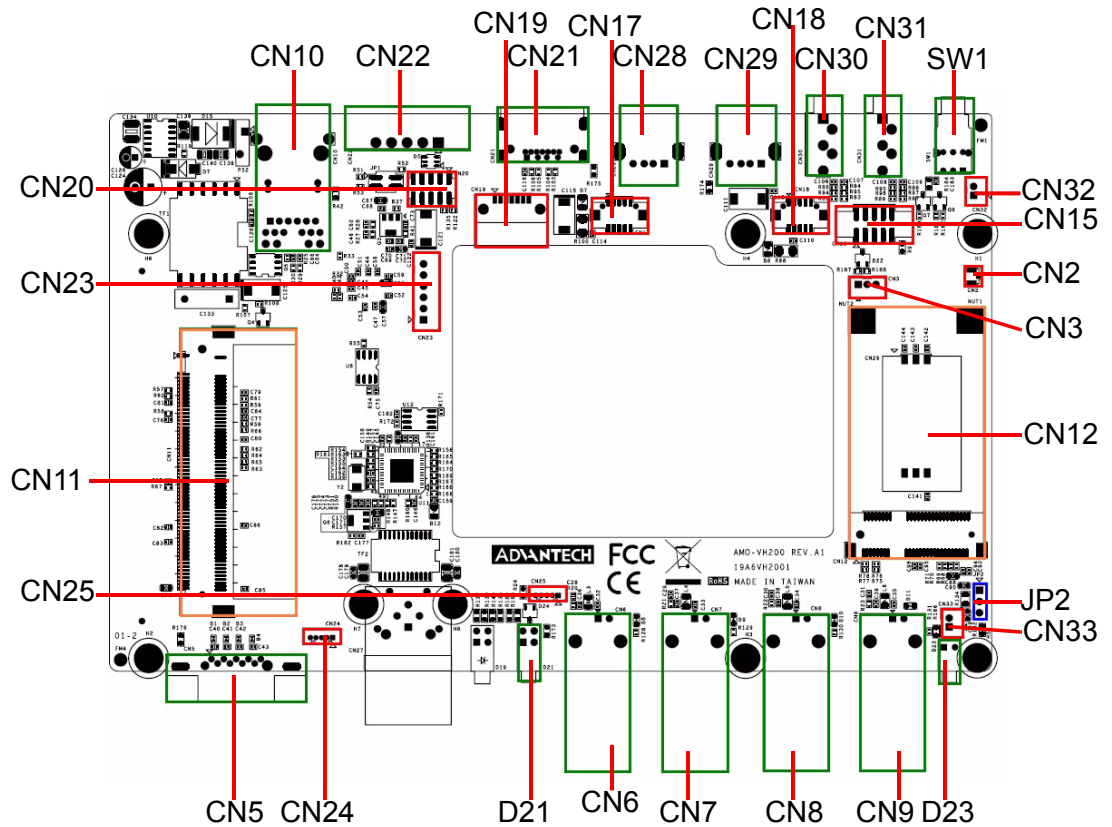
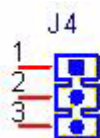

Figure 2.2 Jumper layout (MIO Board)

2.2.4 Jumper Setting Motherboard

J4	CLEAR CMOS
Part Number	1653003101
Footprint	HD_3x1P_79_D
Description	PIN HEADER 3*1P 180D(M) DIP SQUARE W/O Pb
Setting	Function
(1-2)	NORMAL (Default)
(2-3)	CLEAR CMOS



Clear CMOS
1653003101
PH_3x1V_2.00mm

J5	Internal LVDS PANEL POWER Select
Part Number	1653003101
Footprint	HD_3x1P_79_D
Description	PIN HEADER 3*1P 180D(M) 2.0mm DIP SQUARE W/O Pb
Setting	Function
(1-2)	5 V for LVDS PANEL POWER
(2-3)	3.3 V for LVDS PANEL POWER (Default)



MIO Board

JP2	Mini PCI-E Power Setting Header
Part Number	1653003100
Package	PH3x1P-2.54
Description	PIN HEADER 3*1P 180D(M) 2.54mm DIP WO/Pb
Setting	Function
1-2	+V3.3SB (Default)
2-3	+V3.3V

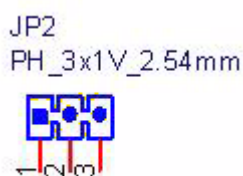

CN2		Antenna IPEX connector for GPS	
Part Number	1654004676		
Package	RF_3P		
Description	RF Conn 3p 180D(M) SMD 105A01-000000-G4		
Pin	Name		
1	GND_GPS		
2	GPS_RFIN		
3	GND_GPS		

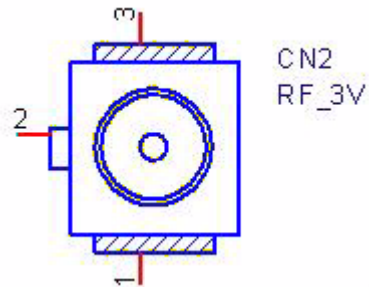

CN3		COM for GPS	
Part Number	1655303020		
Package	WHL3V-2M		
Description	WAFER BOX 2.0mm 3P 180D w/LOCK		
Pin	Name		
1	RXD2		
2	TXD2		
3	GND		

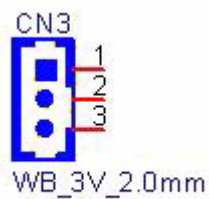

2.3 Connectors

2.3.1 ARK-VH200 External I/O Connectors

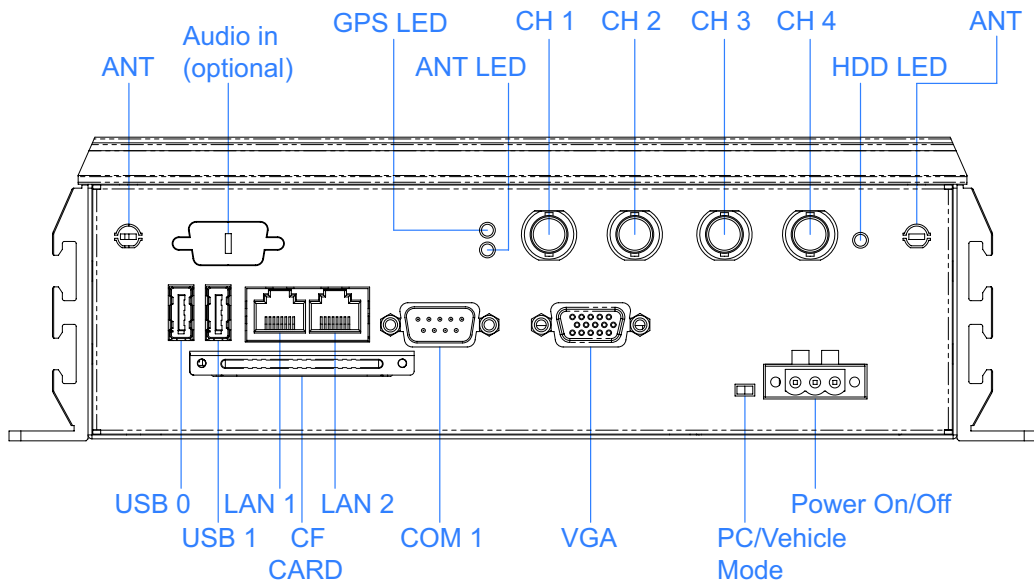

Figure 2.3 Front panel of ARK-VH200

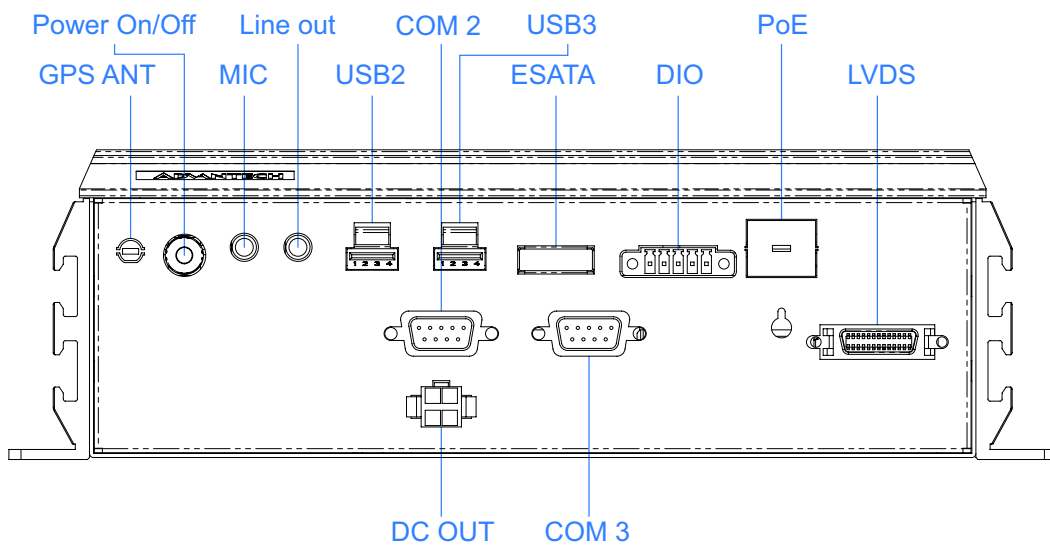

Figure 2.4 Rear panel of ARK-VH200

2.3.1.1 COM Connector

ARK-VH200 provides three D-sub 9-pin connectors.

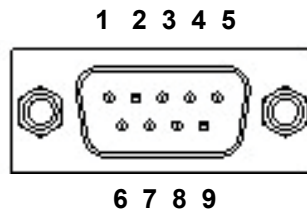

Figure 2.5 COM Port connector

Table 2.3: COM Connector Pin Assignments

RS-232	
Pin	Signal Name
1	DCD
2	RxD
3	TxD
4	DTR
5	GND
6	DSR
7	RTS
8	CTS
9	RI

2.3.1.2 Ethernet Connector (LAN)

ARK-VH200 is equipped with up to three Ethernet controllers that are fully compliant with IEEE 802.3u 10/100/1000 Mbps CSMA/CD standards. LAN1 is equipped with 82567; LAN2 is equipped with 82583V. The Ethernet port provides a standard RJ-45 jack connector with LED indicators on the front side to show its Active/Link status (Green LED) and Speed status (Green/Yellow LED).

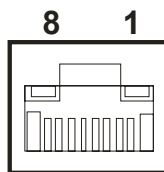

Figure 2.6 Ethernet connector

Table 2.4: Ethernet Connector Pin Assignments

Pin	10/100/1000BaseT Signal Name
1	TX+
2	TX-
3	RX+
4	MDI2+
5	MDI2-
6	RX-
7	MDI3+
8	MDI3-

2.3.1.3 Audio Connector

ARK-VH200 offers two stereo audio ports, each with a phone jack connector: Mic_In and Line_Out. The audio is controlled by ALC888, and it's compliant with Azalea standard.

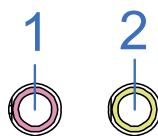

Figure 2.7 Audio connector

Table 2.5: Audio Connector Pin Assignments

Pin	Audio Signal Name
1	Mic_In
2	Line_Out

2.3.1.4 DIO Connector

ARK-VH200 provides one phoenix 5-pin male connector which serves as a Digital Input/Output communication interface. If the client wants to use DIO, pin assignments are as follows.

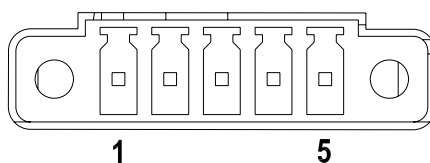

Figure 2.8 DIO Connector

Table 2.6: DIO Connector Pin Assignments

Pin	Signal Name
1	DIO bit0
2	DIO bit1
3	DIO bit2
4	DIO bit3
5	GND

2.3.1.5 USB Connector

ARK-VH200 provides four USB interface connectors, which give complete Plug & Play and hot swapping for up to 127 external devices. The USB interface complies with USB UHCI, Rev. 2.0. The USB interface can be disabled in the system BIOS setup. Please refer to Table. 2.7 for its pin assignments. The USB connectors are used to connect any device that conforms to the USB interface. Most digital devices conform to this standard. The USB interface supports Plug and Play without turning off computers. Note that USB2 and USB3 are lockable USB connectors. When any

USB device is plugged into either of these two connectors, it locks into place. Release the latch plate above the USB2/3 connector to un-plug the USB device.

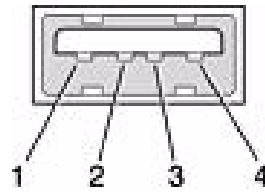

Figure 2.9 USB connector

Table 2.7: USB Connector

Pin	Signal name	Pin	Signal name
1	VCC	2	USB_data-
3	USB_data+	4	GND

2.3.1.6 VGA Connector

The ARK-VH200 provides a high resolution VGA interface connected by a D-sub 15-pin connector to support a VGA CRT monitor. It supports display resolutions up to 2048 x 1536.

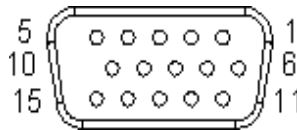

Figure 2.10 VGA Connector

Table 2.8: VGA Connector Pin Assignments

Pin	Signal Name	Pin	Signal Name
1	Red	2	Green
3	Blue	4	NC
5	GND	6	GND
7	GND	8	GND
9	NC	10	GND
11	NC	12	NC
13	H-SYNC	14	V-SYNC
15	NC		

2.3.1.7 Power Input Connector

ARK-VH200 comes with a three-pin header that carries 9~32 VDC external power input. For the in-vehicle power mode, there is one pin for the ignition signal. For the PC ATX mode, the ignition pin can be ignored.

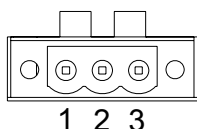

Figure 2.11 Power Input Connector

Table 2.9: Power connector Pin Assignments

Pin	Signal Name
1	Ignition
2	GND
3	+9~32 VDC

2.3.1.8 Power ON/OFF Button

ARK-VH200 comes with a Power On/Off button with LED indicators on the front side to show its On status (Green LED) and Off/Suspend status (Orange LED). Dual functions of Soft Power -On/Off (Instant off or Delay 4 Second), and Suspend are supported.



Figure 2.12 Power Button

2.3.1.9 LED Indicators

There are two LED indicators on ARK-VH200 front panel for indicating system status: GPS LED will flash when it receive GPS signal from satellites; and WLAN LED will flash when it retrieval the data.

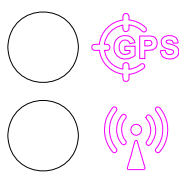

Figure 2.13 LED Indicators

2.3.1.10 Power Output Connector

ARK-VH200 comes with a 4-pin Power Output Connector to provide 5 VDC and 12 VDC power. This power can be use for a panel or other peripherals, but neither should exceed 1A current.

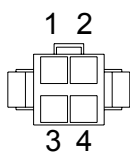

Figure 2.14 Power Output Connector

Table 2.10: Power Output Connector Pin Assignments

Pin	Signal Name
1	GND
2	GND
3	+5V _{DC}
4	+12V _{DC}

2.3.1.11 eSATA/USB Connector

ARK-1382 provides an external SATA connector for external storage; if you do not need to use eSATA, the connector can be used as a USB port.

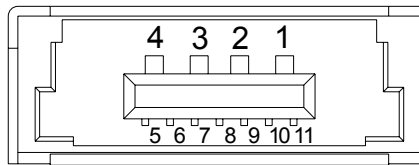
**Figure 2.15 eSATA/USB Connector****Table 2.11: eSATA Connector Pin Assignments**

Pin	Signal Name
1	VBUS
2	D-
3	D+
4	GND
5	GND
6	SATA_TX+
7	SATA_TX-
8	GND
9	SATA_RX-
10	SATA_RX+
11	GND

2.3.1.12 LVDS Connector

The ARK-LVDS comes with a D-Sub 26-pin connector that carries LVDS signal output, and can direct-connect to LVDS LCD display via external cable.

The system also provides a jumper (J5) on the motherboard for selecting the LCD signal power of 5V or 3.3V, please refer to Section 2.2.2 for the jumper table of J5. The default setting for J5 is for 5V.

**Figure 2.16 LVDS Connector**

Table 2.12: LVDS Connector Pin Assignment

Pin	Signal Name	Pin	Signal name
1	CLK2P	14	CLK2M
2	GND	15	A0M
3	A0P	16	A1M
4	A1P	17	A2M
5	A2P	18	CLK1M
6	CLK1P	19	GND
7	VCC_LCD	20	VDD_LCD
8	GND	21	A3M
9	A3P	22	A4M
10	A4P	23	A5M
11	A5P	24	A6M
12	A6P	25	A7M
13	A7P	26	GND

2.4 Installation

2.4.1 HDD Installation

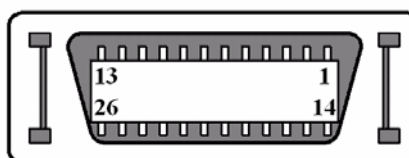
1. Unscrew the HDD door screws on the bottom side of ARK-VH200.

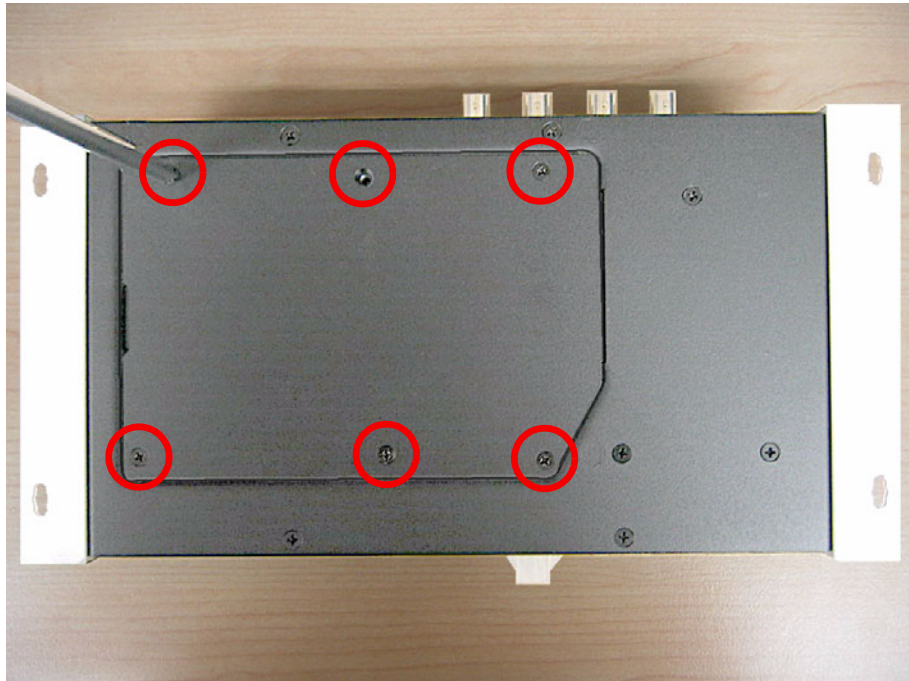

Figure 2.17 Unscrew the HDD door screws

2. Assemble HDD in the HDD frame with four screws.



Figure 2.18 Assemble HDD and HDD frame with 4 screws

3. Use the HDD damper screws to assemble the HDD door and HDD frame.

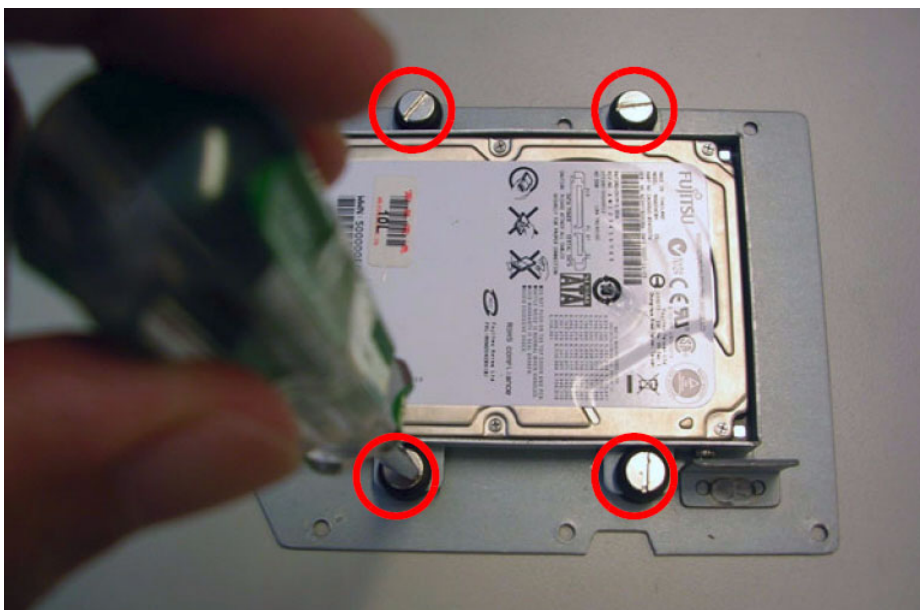

Figure 2.19 Use the HDD damper screws to assemble the HDD door and HDD frame

4. Connect the HDD cables.

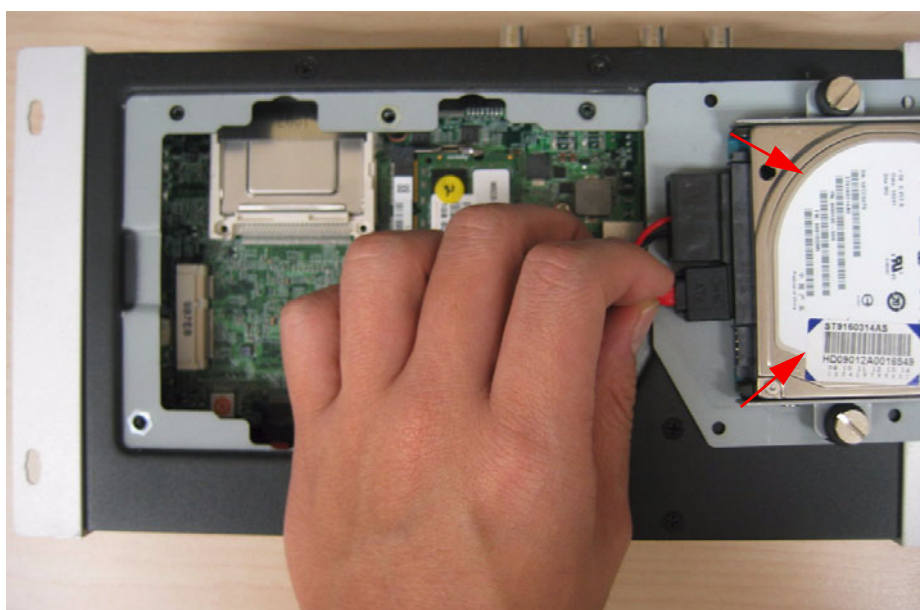

Figure 2.20 Connect the HDD cables

5. Replace HDD door and secure with screws.

2.4.2 Memory Installation

1. Refer to section 2.4.1-1 to open the HDD door.
2. Install the memory module into the SODIMM socket at the bottom of the main board.



Figure 2.21 Install the memory module into the SO-DIMM socket at the bottom of the Main board

3. Replace HDD door and secure with screws.

2.4.3 CF Card Installation

1. Unscrew the CF door screws.

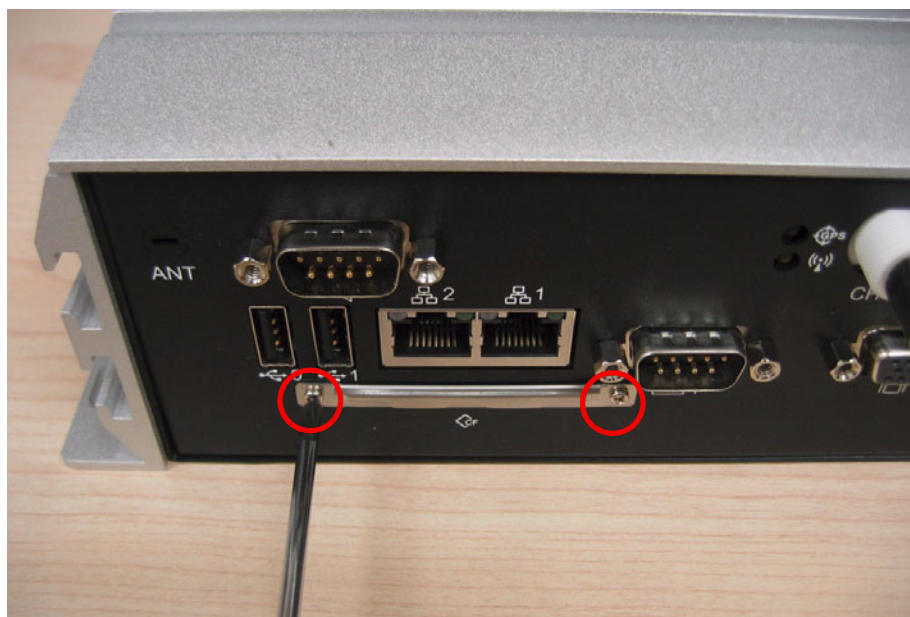

Figure 2.22 Unscrew the CF door screws

2. Pull the CF tray out.

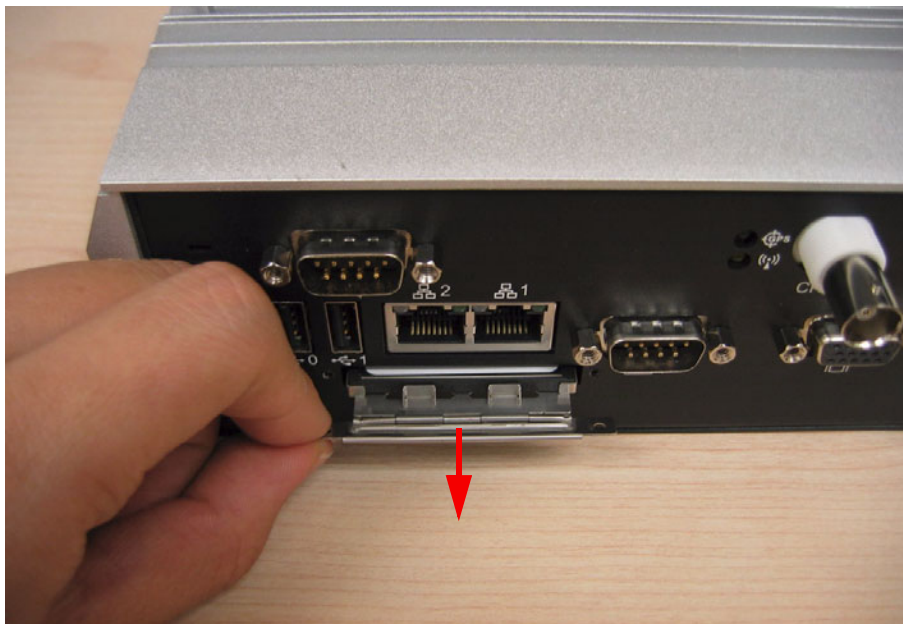

Figure 2.23 Pull the CF tray out

3. Remove the black CF bracket.

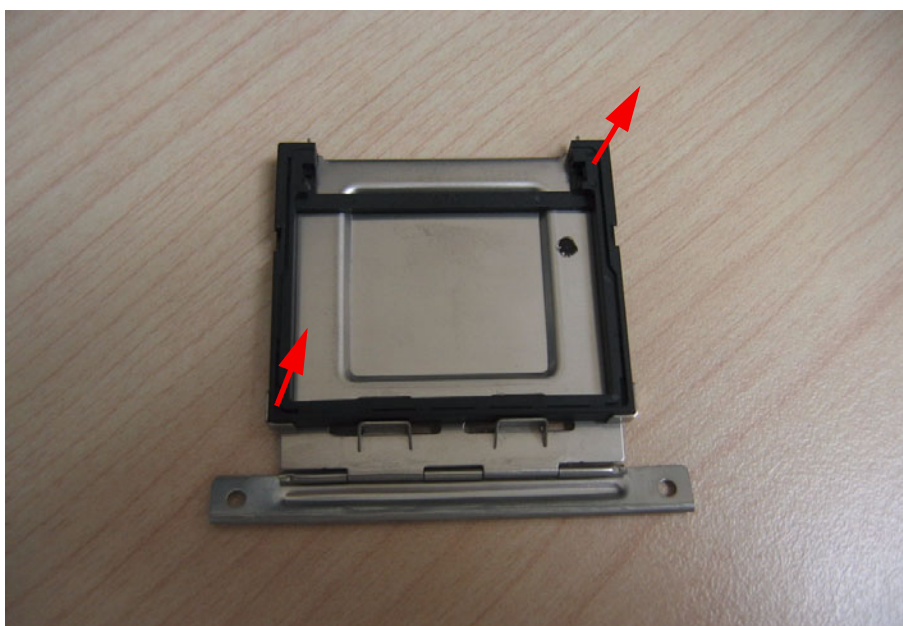

Figure 2.24 Remove CF bracket

- Put CF on to the CF tray.



Figure 2.25 Put CF onto the CF tray

- Push the CF tray back and secure with screws.

2.4.4 Wireless Module Installation

- Unscrew screws of ARK-VH200 top case, and open it.



Figure 2.26 Unscrew the top case screws

2. Remove the ANT hole knockout and screw the SMA Cable into the front panel. The knockout beside the HDD LED is suggested for the miniPCIe device, if any, on the MIO board. The corresponding knockout on the back panel is suggested for the miniPCIe device, again if any, on the bottom of the motherboard.



Figure 2.27 Knock out ANT hole and screw the SMA Cable into the front panel

3. Put the SIM card into the socket if needed. (Only the miniPCIe on the MIO board can support a SIM card.)

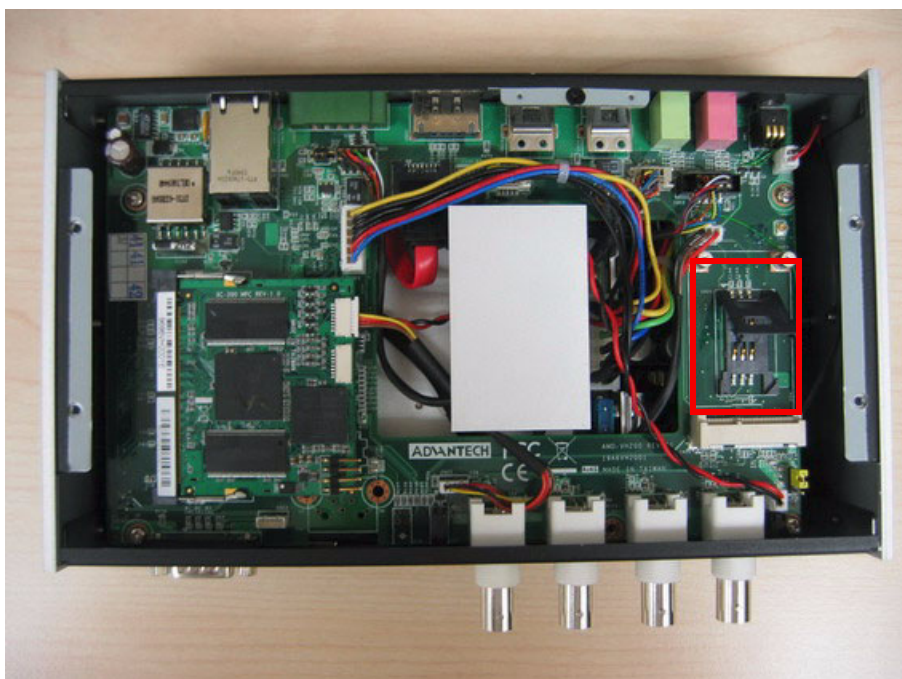

Figure 2.28 Put the SIM card into the socket

4. Insert the miniPCIe card module and screw it onto the socket.

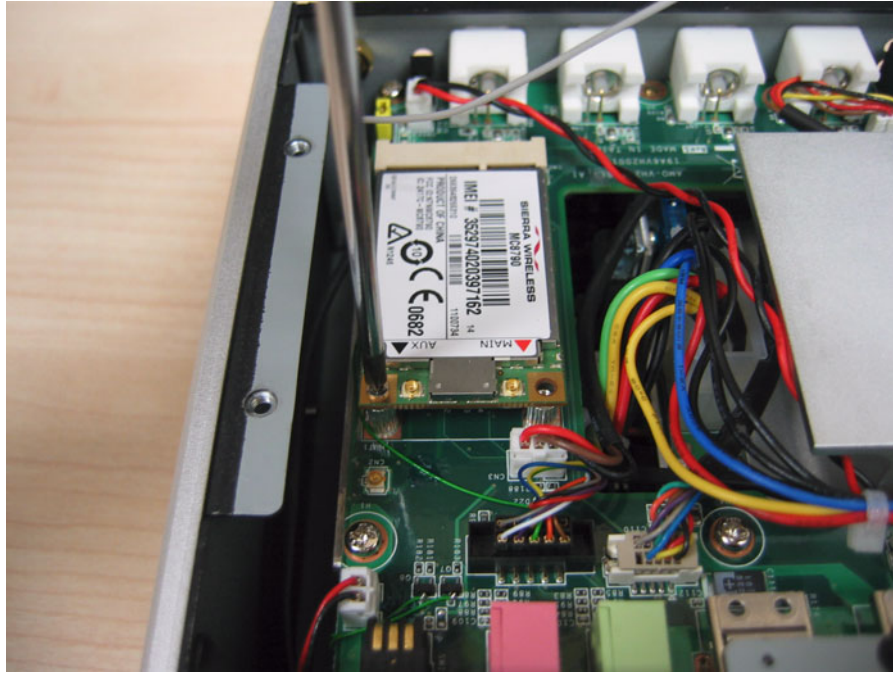

Figure 2.29 Insert the miniPCIe card module

5. Connect the SMA Cable to the miniPCIe card module.



Figure 2.30 Connect the SMA Cable to the miniPCIe card module

6. Replace top case cover and secure the screws.

Chapter 3

BIOS Settings

This chapter introduces how to set BIOS configuration data.

AMIBIOS has been integrated into many motherboards for over two decades. With the AMIBIOS Setup program, you can modify BIOS settings and control the various system features. This chapter describes the basic navigation of the ARK-VH200 BIOS setup screens.

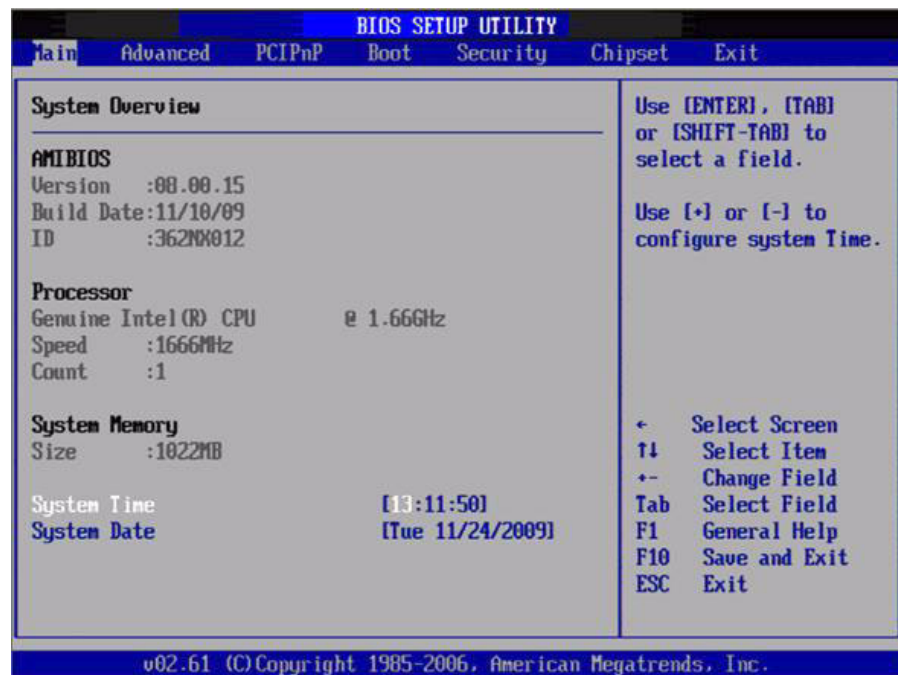

Figure 3.1 Setup Program Initial Screen

AMI's BIOS ROM has a built-in Setup program that allows users to modify the basic system configuration. This information is stored in battery-backed CMOS so it retains the Setup information when the power is turned off.

3.1 Entering BIOS Setup

Turn on the computer and check for the “patch code”. If there is a number assigned to the patch code, it means that the BIOS supports your CPU. If there is no number assigned to the patch code, please contact an Advantech application engineer to obtain an up-to-date patch code file. This will ensure that your CPU's system status is valid. After ensuring that you have a number assigned to the patch code, immediately press and you will enter Setup.

3.2 Main Menu

When you first enter the BIOS Setup Utility, you will enter the Main setup screen. You can always return to the Main setup screen by selecting the Main tab. There are two Main Setup options. They are described in this section. The Main BIOS Setup screen is shown below.

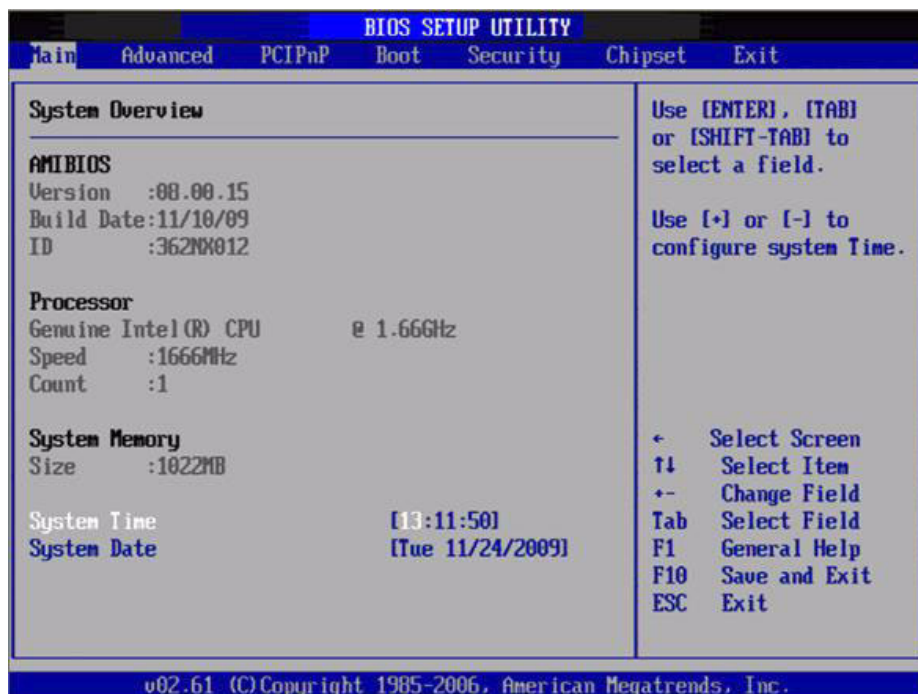

Figure 3.2 Main Setup Screen

The Main BIOS setup screen has two main frames. The left frame displays all the options that can be configured. Grayed-out options cannot be configured; options in blue can. The right frame displays the key legend.

Above the key legend is an area reserved for a text message. When an option is selected in the left frame, it is highlighted in white. Often a text message will accompany it.

3.2.1 System Time / System Date

Use this option to change the system time and date. Highlight System Time or System Date using the <Arrow> keys. Enter new values through the keyboard. Press the <Tab> key or the <Arrow> keys to move between fields. The date must be entered in MM/DD/YY format. The time must be entered in HH:MM:SS format.

3.3 Advanced BIOS Features Setup

Select the Advanced tab from the ARK-VH200 setup screen to enter the Advanced BIOS Setup screen. You can select any of the items in the left frame of the screen, such as CPU Configuration, to go to the sub menu for that item. You can display an Advanced BIOS Setup option by highlighting it using the <Arrow> keys. All Advanced BIOS Setup options are described in this section. The Advanced BIOS Setup screens is shown below. The sub menus are described on the following pages.

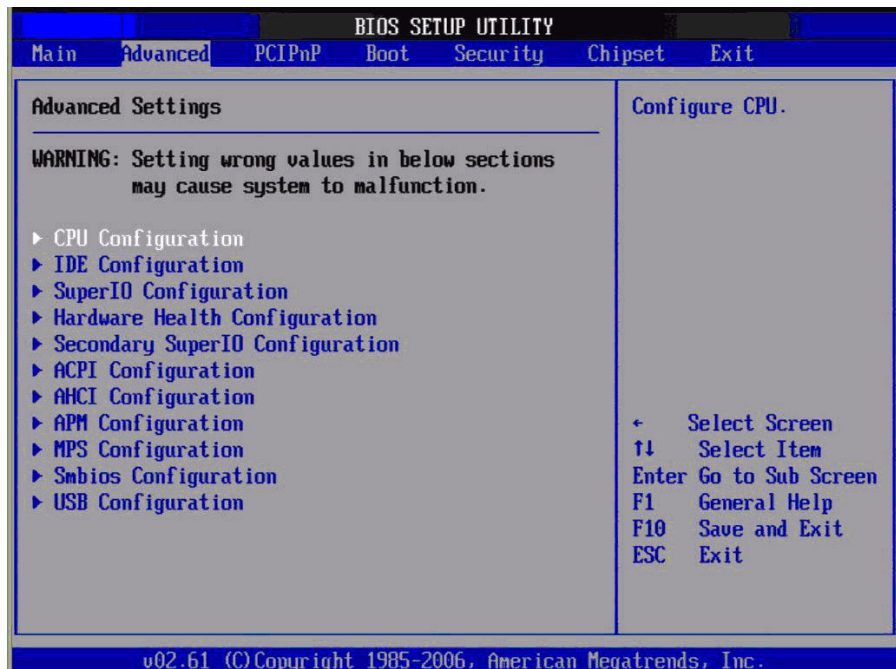

Figure 3.3 Advanced BIOS Features Setup Screen

3.3.1 CPU Configuration

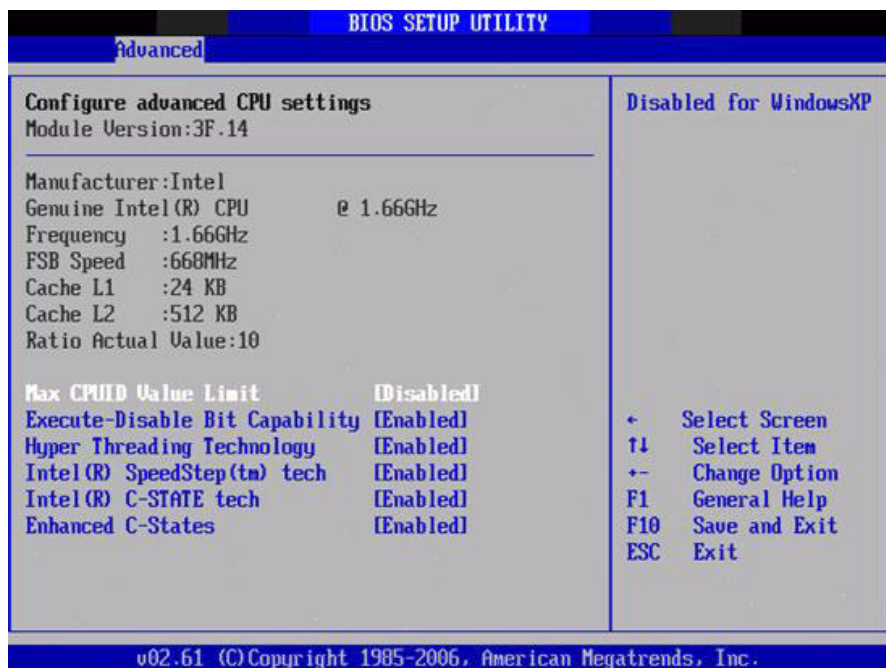

Figure 3.4 CPU Configuration Setting

- **Max CPUID Value Limit**
This item allows you to limit CPUID maximum value.
- **Execute-Disable Bit Capability**
This item allows you to enable or disable the No-Execution page protection technology.
- **Hyper Threading Technology**
This item allows you to enable or disable Intel® Hyper Threading technology.

- **Intel® SpeedStep® Tech**
When set to disabled, the CPU runs at its default speed, when set to enabled, the CPU speed is controlled by the operating system.
- **Intel® C-STATE tech**
This item allows the CPU to save more power under idle mode.
- **Enhanced C-States**
CPU idle set to enhanced C-States, disabled by Intel® C-STATE tech item.

3.3.2 IDE Configuration



Figure 3.5 IDE Configuration

- **ATA/IDE Configuration**
This item allows you to select Disabled / Compatible / Enhanced.
- **Legacy IDE Channels**
When set to Enhanced mode you can select IDE or AHCI mode. When select Compatible mode you can select SATA only / SATA pri, PATA sec or PATA only.
- **Primary/Secondary/Third IDE Master/Slave**
BIOS auto detects the presence of IDE device, and displays the status of auto detection of IDE device.
 - **Type:** Select the type of SATA driver.[Not Installed][Auto][CD/DVD][ARMD]
 - **LBA/Large Mode:** Enables or Disables the LBA mode.
 - **Block (Multi-Sector Transfer):** Enables or disables data multi-sectors transfers.
 - **PIO Mode:** Select the PIO mode.
 - **DMA Mode:** Select the DMA mode.
 - **S.M.A.R.T.:** Select the smart monitoring, analysis, and reporting technology.
 - **32Bit Data Transfer:** Enables or disables 32-bit data transfer.
- **Hard Disk Write Protect**
Disable/Enable device write protection. This will be effective only if device is accessed through BIOS.

- **IDE Detect Time Out (Sec)**

This item allows you to select the time out value for detecting ATA/ATAPI device(s).

3.3.3 Super I/O Configuration

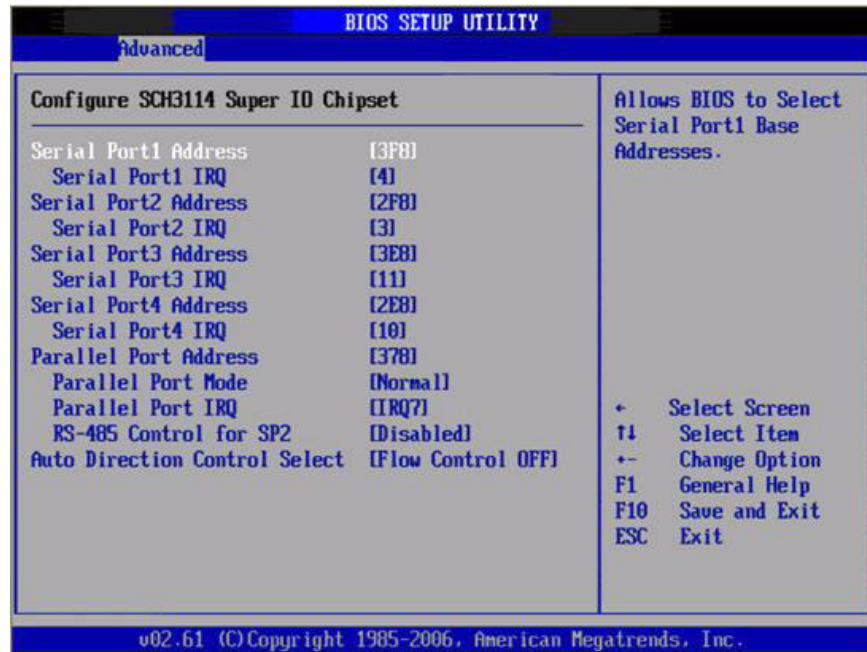

Figure 3.6 Super I/O Configuration

- **Serial Port1 / Port2 / Port3 / Port 4 address (Port 4 is for GPS communication)**

This item allows you to select serial port1 ~ port4 of base addresses.

- **Serial Port1 / Port2 / Port3 / Port 4 IRQ (Port 4 is for GPS communication)**

This item allows you to select serial port1 ~ port4 of IRQ.

- **Parallel Port Address (optional)**

This item allows you to select Parallel port address.

- **Parallel Port Mode (optional)**

This item allows you to select Parallel port Mode.

- **Parallel Port IRQ (optional)**

This item allows you to select Parallel port IRQ.

- **RS-485 Control for SP2**

This item allows you to select RS485 control.

- **Auto Direction Control Select**

This item allows you to enable or disable auto flow control function.

3.3.4 Hardware Health Configuration



Figure 3.7 Hardware Health Configuration

- **H/W Health Function**
This item allows you to control H/W monitor of showing.
- **Temperature & Voltage Show**
CPU/System Temperature
Vcore / +3.3 Vin / +5 Vin / +12 Vin / VBAT

3.3.5 ACPI Settings



Figure 3.8 ACPI Setting

3.3.5.1 General ACPI Configuration

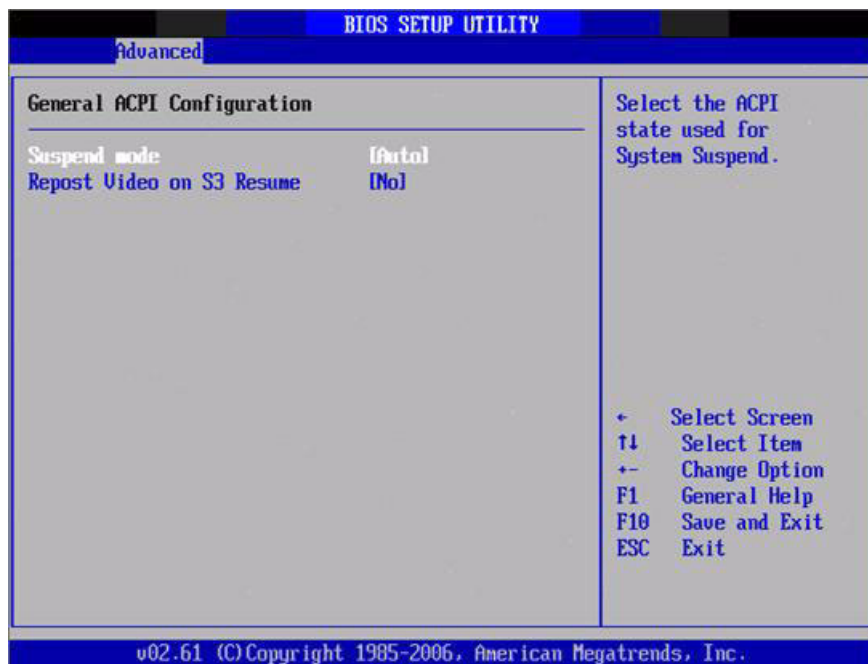

Figure 3.9 General ACPI Configuration

- **Suspend Mode**
Select the ACPI state used for system suspend.
- **Report Video on S3 Resume**
This item allows you to invoke VA BIOS POST on S3/STR resume.

3.3.5.2 Advanced ACPI Configuration

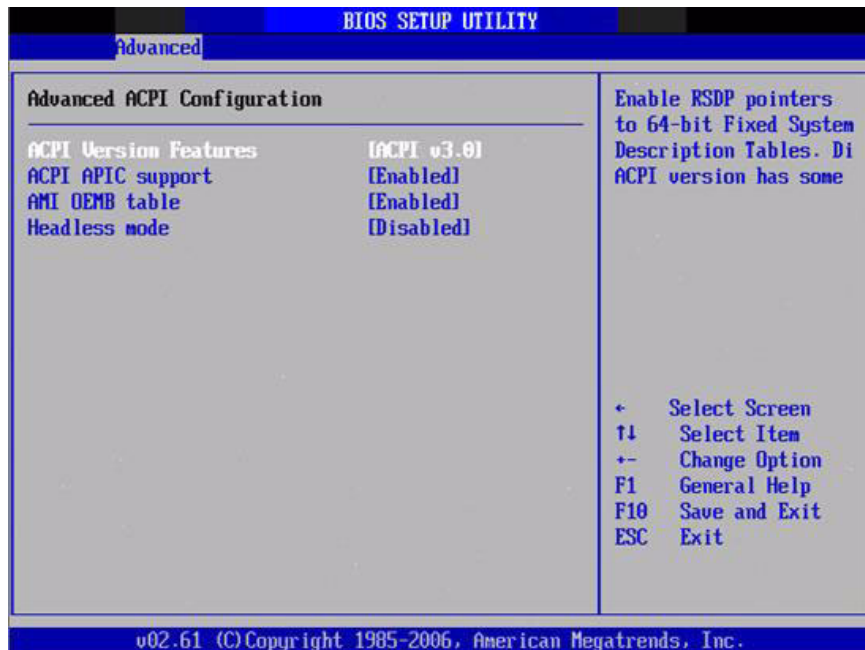

Figure 3.10 Advanced ACPI Configuration

- **ACPI Version Features**
This item allows you to enable RSDP pointers to 64-bit fixed system description tables.
- **ACPI APIC support**
Include APIC table pointer to RSDT pointer list.
- **AMI OEMB table**
Include OEMB table pointer to R(x)SDT pointer lists.
- **Headless mode**
Enable / Disable Headless operation mode through ACPI.

3.3.5.3 Chipset ACPI Configuration



Figure 3.11 Chipset ACPI Configuration

- **Energy Lake Feature**
Allows you to configure Intel's Energy Lake power management technology.
- **APIC ACPI SCI IRQ**
Enable/Disable APIC ACPI SCI IRQ.
- **USB Device Wakeup From S3/S4**
Enable/Disable USB Device Wakeup from S3/S4.
- **High Performance Event Timer**
Enable/Disable High performance Event timer.

3.3.6 AHCI Setting

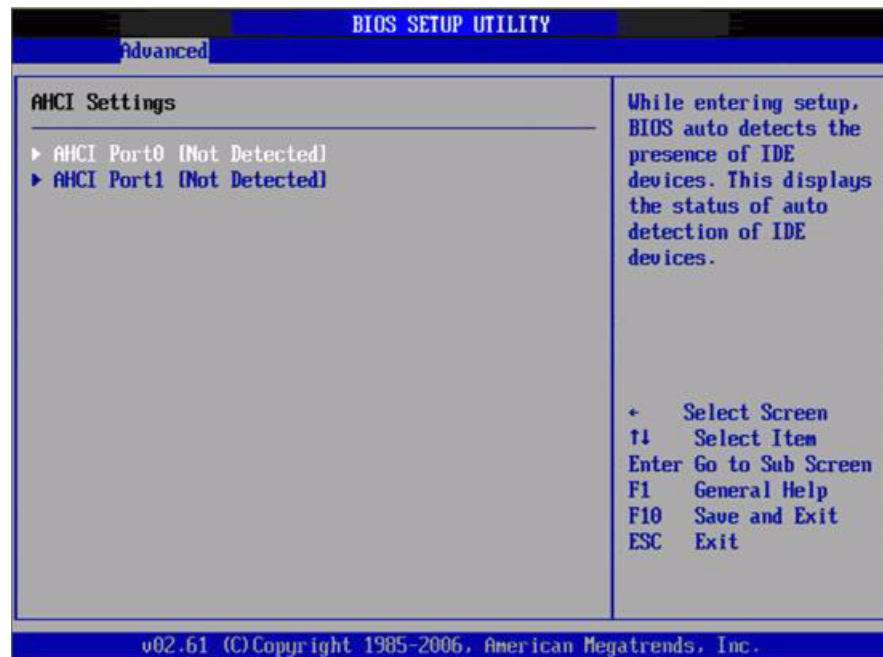

Figure 3.12 AHCI Setting

- **AHCI Port0 / Port**

While entering setup, BIOS auto detects the presence of IDE devices. This displays the status of auto detection of IDE device.

3.3.7 APM Configuration



Figure 3.13 APM Configuration

- **Power Management/APM**
Enable or disable APM.
- **Power Button Mode**
Power on, off, or enter suspend mode when the power button is pressed. The following options are also available.
- **Restore on AC power Loss**
Use this to set up the system response after a power failure. The "Off" setting keeps the system powered off after power failure, the "On" setting boots up the system after failure, and the "Last State" returns the system to the status just before power failure.
- **Video Power Down Mode**
Power down video in suspend or standby mode.
- **Hard Disk Power Down Mode**
Power down Hard Disk in suspend or standby mode.
- **Standby Time Out**
Go into standby in the specified time.
- **Suspend Time Out**
Go into Suspend in the specified time.
- **Resume On Ring**
Enable / Disable RI to generate a wake event.
- **Resume On PME#**
Enable / Disable PME to generate a wake event.
- **Resume On RTC Alarm**
Enable / Disable RTC to generate a wake event.

3.3.8 Event Log Configuration



Figure 3.14 Event Log Configuration

- **View Event Log**
View all unread events on the event Log.
- **Mark all events as read**
Mark all unread events as read.
- **Clear Event Log**
Discard all events in the event Log.

3.3.9 MPS Configuration



Figure 3.15 MPS Configuration

- **MPS Revision**
This item allows you to select MPS version.

3.3.10 Smbios Configuration

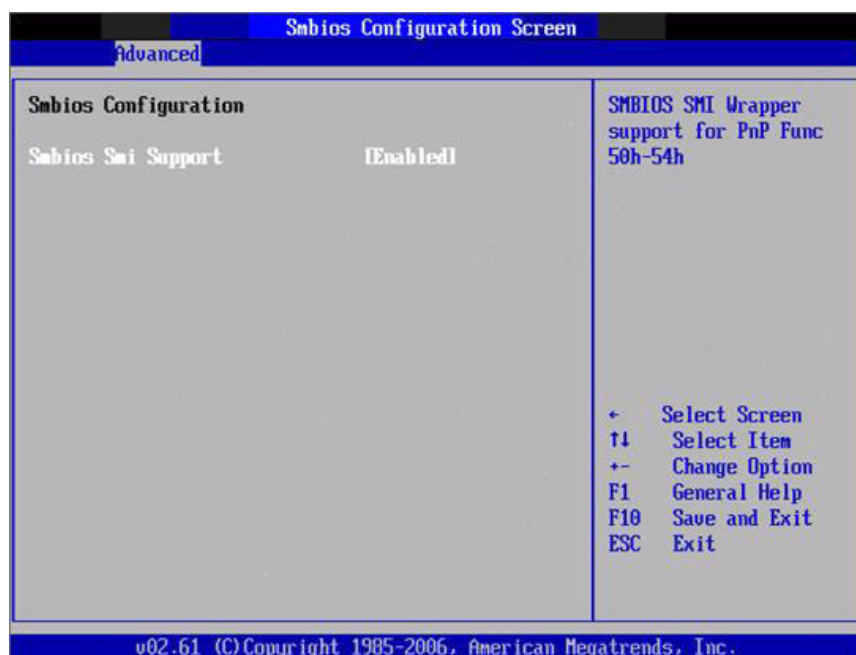

Figure 3.16 Smbios Configuration

- **Smbios Smi Support**
SMBIOS SMI wrapper support for PnP function 50h-54h.

3.3.11 USB Configuration



Figure 3.17 USB Configuration

- **Legacy USB Support**
Enables support for legacy USB. Auto option disables legacy support if no USB devices are connected.
- **USB 2.0 Controller Mode**
This item allows you to select HiSpeed (480Mbps) or FullSpeed (12Mbps).
- **BIOS EHCI Hand-Off**
This is a workaround for OSES without EHCI hand-off support. The EHCI ownership change should claim by EHCI driver.
- **Hotplug USB FDD Support**
A dummy FDD device is created that will be associated with the hotplugged FDD later. Auto option creates this dummy device only if there is no USB FDD present.

3.3.11.1 USB Mass Storage Device Configuration



Figure 3.18 USB Mass storage Device Configuration

- **USB Mass Storage Reset Delay**
Number of sends POST wait for the USB mass storage device after start unit command.
- **Emulation Type**
If Auto, USB devices less than 530MB will be emulated as Floppy and remaining as hard drive. Force FDD option can be used to force a FDD formatted drive to boot as FDD (E.G., a ZIP drive).

3.4 Advanced PCI/PnP Settings

Select the PCI/PnP tab from the ARK-VH200 setup screen to enter the Plug and Play BIOS Setup screen. You can display a Plug and Play BIOS Setup option by highlighting it using the <Arrow> keys. All Plug and Play BIOS Setup options are described in this section. The Plug and Play BIOS Setup screen is shown below.



Figure 3.19 PCI/PnP Setup (top)

- **Clear NVRAM**
Set this value to force the BIOS to clear the Non-Volatile Random Access Memory (NVRAM). The Optimal and Fail-Safe default setting is No.
- **Plug & Play O/S**
When set to No, BIOS configures all the device in the system. When set to Yes and if you install a Plug and Play operating system, the operating system configures any Plug and Play device not required for boot.
- **PCI Latency Timer**
Value in units of PCI clocks for PCI device latency timer register.
- **Allocate IRQ to PCI VGA**
When set to Yes will assigns IRQ to PCI VGA card if card requests IRQ. When set to No will not assign IRQ to PCI VGA card even if card requests an IRQ.
- **Palette Snooping**
This item is designed to solve problems caused by some non-standard VGA card.
- **PCI IDE BusMaster**
When set to enabled BIOS uses PCI busmastering for reading/writing to IDE drives.
- **OffBoard PCI/ISA IDE Card**
Some PCI IDE cards may require this to be set to the PCI slot number that is holding the card. Auto works for most PCI IDE cards.

- **IRQ3 / 4 / 5 / 7 / 9 / 10 / 11**
This item allows you assign interrupts IRQ-3, 4, 5, 7, 9, 10, and 11, respectively.
- **DMA Channel0 / 1 / 3 / 5 / 6 / 7**
When set to Available will specified DMA is available to be used by PCI/PnP devices. When set to Reserved will specified DMA will Reserved for use by legacy ISA devices.
- **Reserved Memory Size**
This item allows you to reserve a memory block for legacy ISA devices.

3.5 Boot Settings

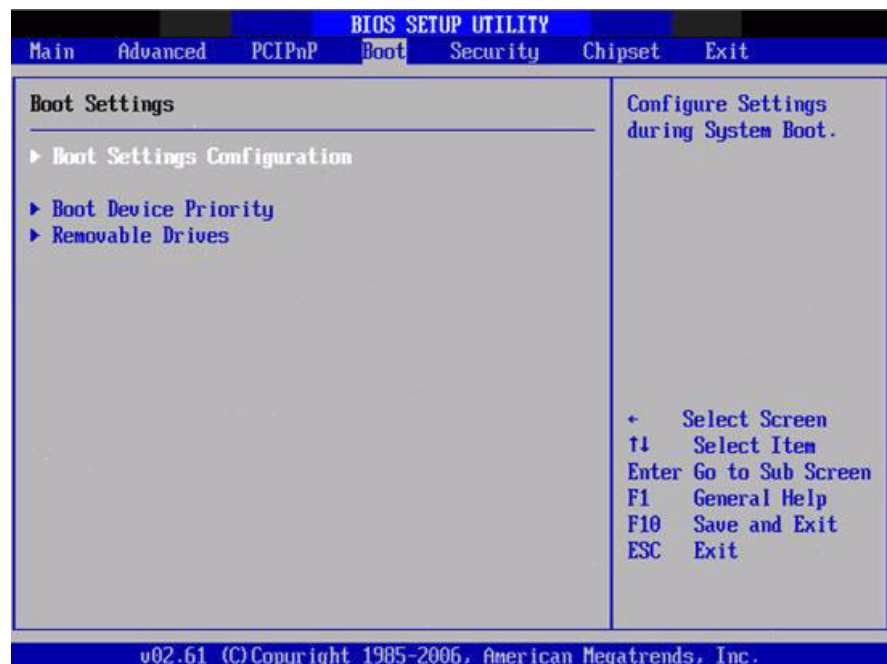

Figure 3.20 Boot Setup Utility

3.5.1 Boot Settings Configuration

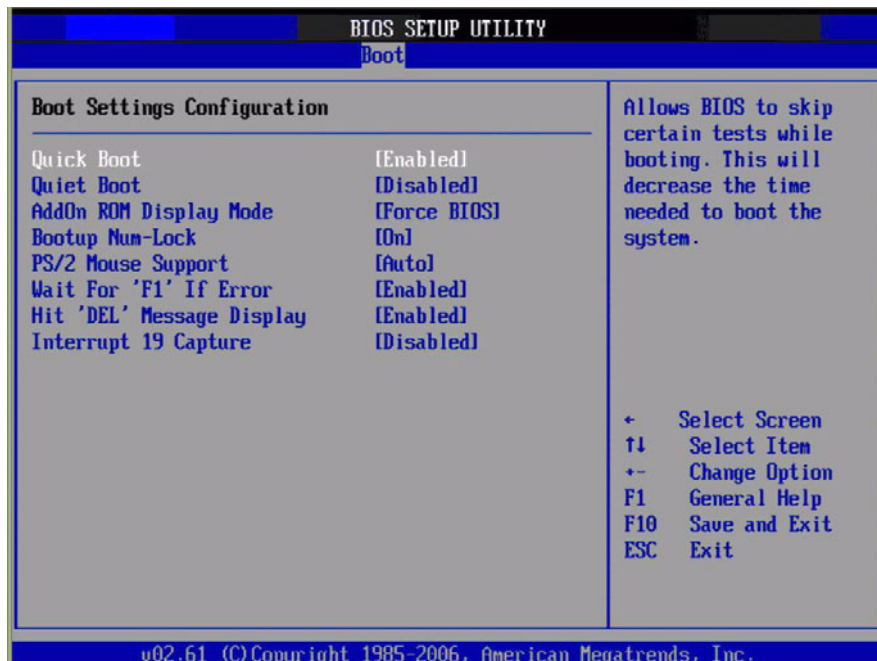

Figure 3.21 Boot Setting Configuration

- **Quick Boot**
This item allows BIOS to skip certain tests while booting. This will decrease the time needed to boot the system.
- **Quiet Boot**
If this option is set to Disabled, the BIOS displays normal POST messages. If Enabled, an OEM Logo is shown instead of POST messages.
- **AddOn ROM Display Mode**
Set display mode for option ROM.
- **Bootup Num-Lock**
Select the Power-on state for Numlock.
- **PS/2 Mouse Support**
Select support for PS/2 Mouse.
- **Wait For "F1" If Error**
Wait for the F1 key to be pressed if an error occurs.
- **Hit "DEL" Message Display**
Displays - Press DEL to run Setup in POST.
- **Interrupt 19 Capture**
This item allows option ROMs to trap interrupt 19.

3.6 Security Setup



Figure 3.22 Password Configuration

Select Security Setup from the ARK-VH200 Setup main BIOS setup menu. All Security Setup options, such as password protection and virus protection are described in this section. To access the sub menu for the following items, select the item and press <Enter>:

- **Change Supervisor / User Password**
- **Boot sector Virus protection:**

The boot sector virus protection will warn if any program tries to write to the boot sector.

3.7 Advanced Chipset Settings



Figure 3.23 Advanced Chipset Settings

3.7.1 North Bridge Chipset Configuration



Figure 3.24 North Bridge Configuration

- **DRAM Frequency**
This item allows you to manually changed DRAM frequency.
- **Configure DRAM Timing by SPD**
This item allows you to enable or disable detect by DRAM SPD.

- **Memory Hole**
This item allows you to free 15MB-16MB of memory for some ISA devices.
- **Initiate Graphic Adapter**
This item allows you to select which graphics controller to use as the primary boot device.
- **Internal Graphics Mode Select:**
Select the amount of system memory used by the internal graphics device.

3.7.1.1 Video function configuration



Figure 3.25 Video function configuration

- **DVMT Mode Select**
Displays the active system memory mode.
- **DVMT/FIXED Memory**
Specify the amount of DVMT / FIXED system memory to allocate for video memory.
- **Boot Display Device**
Select boot display device at post stage.
- **Flat Panel Type**
This item allows you to select panel resolution.
- **Spread Spectrum Clock**
This item allows you to enable or disable spread spectrum clock.

3.7.2 South Bridge Chipset Configuration

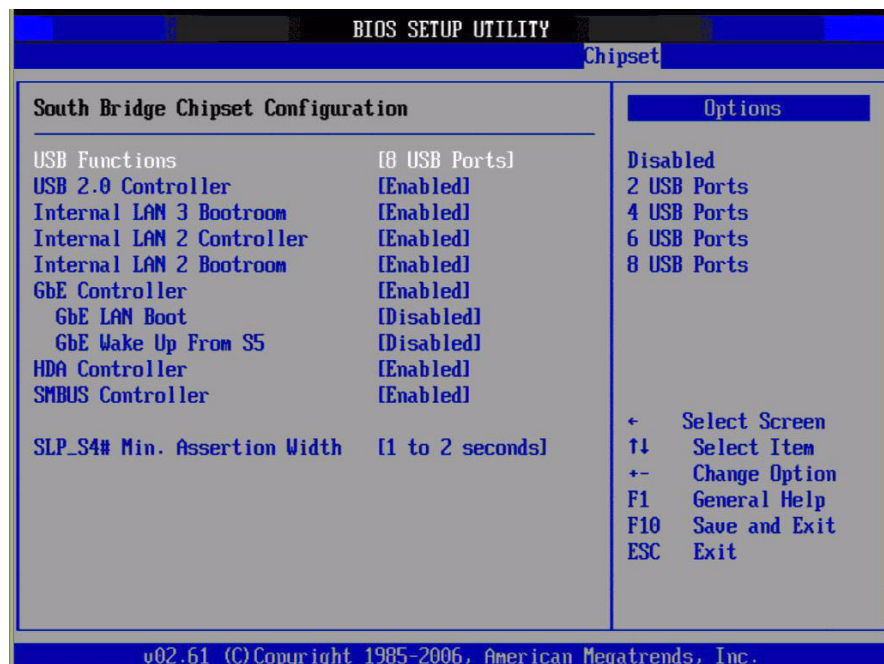

Figure 3.26 South Bridge Configuration

- **USB Functions**
Disabled, 2 USB Ports, 4 USB Ports, 6 USB Ports or 8 USB Ports.
- **USB 2.0 Controller**
Enables or disables the USB 2.0 controller.
- **Internal LAN3 Bootroom**
Enables or disables internal LAN boot with LAN3.
- **Internal LAN2 controller**
Enables or disables the internal LAN controller with LAN2.
- **Internal LAN2 Bootroom**
Enables or disables internal LAN boot with LAN2.
- **GbE controller**
Enables or disables the GbE controller with LAN1.
- **GbE LAN Boot**
Enables or disables GbE LAN boot with LAN1.
- **GbE Wake Up From S5**
Enables or disables GbE LAN wake up from S5 function.
- **HDA Controller**
Enables or disables the HDA controller.
- **SMBUS Controller**
Enables or disables the SMBUS controller.
- **SLP_S4# Min. Assertion Width**
This item allows you to set a minimum assertion width of the SLP-S4# signal to guarantee that memory has been safely power-cycled.

3.8 Exit OS



Figure 3.27 Exit Option

3.8.1 Save Changes and Exit

When you have completed system configuration, select this option to save your changes, exit BIOS setup and reboot the computer so the new system configuration parameters can take effect.

1. Select Exit Saving Changes from the Exit menu and press <Enter>. The following message appears: Save Configuration Changes and Exit Now? [OK] [Cancel]
2. Select Ok or cancel.

3.8.2 Discard Changes and Exit

Select this option to quit Setup without making any permanent changes to the system configuration.

1. Select Exit Discarding Changes from the Exit menu and press <Enter>. The following message appears: Discard Changes and Exit Setup Now? [Ok] [Cancel]
2. Select Ok to discard changes and exit. Changes are discarded before exiting.

3.8.3 Load Optimal Defaults

The ARK-VH200 automatically configures all setup items to optimal settings when you select this option. Optimal Defaults are designed for maximum system performance, but may not work best for all computer applications. In particular, do not use the Optimal Defaults if your computer is experiencing system configuration problems. Select Load Optimal Defaults from the Exit menu and press <Enter>.

3.8.4 Load Fail-Safe Defaults

The ARK-VH200 automatically configures all setup options to fail-safe settings when you select this option. Fail-Safe Defaults are designed for maximum system stability,

but not maximum performance. Select Fail-Safe Defaults if your computer is experiencing system configuration problems.

1. Select Load Fail-Safe Defaults from the Exit menu and press <Enter>. The following message appears: Load Fail-Safe Defaults? [OK] [Cancel]
2. Select OK to load Fail-Safe defaults.

Trusted ePlatform Services

ADVANTECH

www.advantech.com

Please verify specifications before quoting. This guide is intended for reference purposes only.

All product specifications are subject to change without notice.

No part of this publication may be reproduced in any form or by any means, electronic, photocopying, recording or otherwise, without prior written permission of the publisher.

All brand and product names are trademarks or registered trademarks of their respective companies.

© Advantech Co., Ltd. 2010