



**User Manual**

# **ARK-3202**

**Compact Embedded IPC**

*Trusted ePlatform Services*

**ADVANTECH**

---

## Copyright

The documentation and the software included with this product are copyrighted 2009 by Advantech Co., Ltd. All rights are reserved. Advantech Co., Ltd. reserves the right to make improvements in the products described in this manual at any time without notice.

No part of this manual may be reproduced, copied, translated or transmitted in any form or by any means without the prior written permission of Advantech Co., Ltd. Information provided in this manual is intended to be accurate and reliable. However, Advantech Co., Ltd. assumes no responsibility for its use, nor for any infringements of the rights of third parties, which may result from its use.

## Acknowledgements

Award is a trademark of Award Software International, Inc.

VIA is a trademark of VIA Technologies, Inc.

IBM, PC/AT, PS/2 and VGA are trademarks of International Business Machines Corporation.

Intel® and Pentium® are trademarks of Intel Corporation.

Microsoft Windows® is a registered trademark of Microsoft Corp.

RTL is a trademark of Realtek Semi-Conductor Co., Ltd.

ESS is a trademark of ESS Technology, Inc.

UMC is a trademark of United Microelectronics Corporation.

SMI is a trademark of Silicon Motion, Inc.

Creative is a trademark of Creative Technology LTD.

CHRONTEL is a trademark of Chrontel Inc.

All other product names or trademarks are properties of their respective owners.

For more information about this and other Advantech products, please visit our website at:

<http://www.advantech.com/>

<http://www.advantech.com/ePlatform/>

For technical support and service, please visit our support website at:

<http://support.advantech.com.tw/support/>

## Product Warranty (2 years)

Advantech warrants to you, the original purchaser, that each of its products will be free from defects in materials and workmanship for two years from the date of purchase.

This warranty does not apply to any products which have been repaired or altered by persons other than repair personnel authorized by Advantech, or which have been subject to misuse, abuse, accident or improper installation. Advantech assumes no liability under the terms of this warranty as a consequence of such events.

Because of Advantech's high quality-control standards and rigorous testing, most of our customers never need to use our repair service. If an Advantech product is defective, it will be repaired or replaced at no charge during the warranty period. For out-of-warranty repairs, you will be billed according to the cost of replacement materials, service time and freight. Please consult your dealer for more details.

If you think you have a defective product, follow these steps:

1. Collect all the information about the problem encountered. (For example, CPU speed, Advantech products used, other hardware and software used, etc.) Note anything abnormal and list any onscreen messages you get when the problem occurs.
2. Call your dealer and describe the problem. Please have your manual, product, and any helpful information readily available.
3. If your product is diagnosed as defective, obtain an RMA (return merchandise authorization) number from your dealer. This allows us to process your return more quickly.
4. Carefully pack the defective product, a fully-completed Repair and Replacement Order Card and a photocopy proof of purchase date (such as your sales receipt) in a shippable container. A product returned without proof of the purchase date is not eligible for warranty service.
5. Write the RMA number visibly on the outside of the package and ship it prepaid to your dealer.

## Declaration of Conformity

### FCC Class A

Note: This equipment has been tested and found to comply with the limits for a Class A digital device, pursuant to part 15 of the FCC Rules. These limits are designed to provide reasonable protection against harmful interference when the equipment is operated in a commercial environment. This equipment generates, uses, and can radiate radio frequency energy and, if not installed and used in accordance with the instruction manual, may cause harmful interference to radio communications. Operation of this equipment in a residential area is likely to cause harmful interference in which case the user will be required to correct the interference at his own expense.

---

## Technical Support and Assistance

1. Visit the Advantech web site at [www.advantech.com/support](http://www.advantech.com/support) where you can find the latest information about the product.
2. Contact your distributor, sales representative, or Advantech's customer service center for technical support if you need additional assistance. Please have the following information ready before you call:
  - Product name and serial number
  - Description of your peripheral attachments
  - Description of your software (operating system, version, application software, etc.)
  - A complete description of the problem
  - The exact wording of any error messages

## Warnings, Cautions and Notes

**Warning!** *Warnings indicate conditions, which if not observed, can cause personal injury!*



**Caution!** *Cautions are included to help you avoid damaging hardware or losing data. e.g.*



*There is a danger of a new battery exploding if it is incorrectly installed. Do not attempt to recharge, force open, or heat the battery. Replace the battery only with the same or equivalent type recommended by the manufacturer. Discard used batteries according to the manufacturer's instructions.*

**Note!** *Notes provide optional additional information.*



# Safety Instructions

1. Read these safety instructions carefully.
2. Keep this User Manual for later reference.
3. Disconnect this equipment from any AC outlet before cleaning. Use a damp cloth. Do not use liquid or spray detergents for cleaning.
4. For plug-in equipment, the power outlet socket must be located near the equipment and must be easily accessible.
5. Keep this equipment away from humidity.
6. Put this equipment on a reliable surface during installation. Dropping it or letting it fall may cause damage.
7. The openings on the enclosure are for air convection. Protect the equipment from overheating. **DO NOT COVER THE OPENINGS.**
8. Make sure the voltage of the power source is correct before connecting the equipment to the power outlet.
9. Position the power cord so that people cannot step on it. Do not place anything over the power cord.
10. All cautions and warnings on the equipment should be noted.
11. If the equipment is not used for a long time, disconnect it from the power source to avoid damage by transient overvoltage.
12. Never pour any liquid into an opening. This may cause fire or electrical shock.
13. Never open the equipment. For safety reasons, the equipment should be opened only by qualified service personnel.  
If one of the following situations arises, get the equipment checked by service personnel:
  - The power cord or plug is damaged.
  - Liquid has penetrated into the equipment.
  - The equipment has been exposed to moisture.
  - The equipment does not work well, or you cannot get it to work according to the user's manual.
  - The equipment has been dropped and damaged.
  - The equipment has obvious signs of breakage.
14. Do not leave this equipment in an environment where the storage temperature may go below  $-20^{\circ}\text{C}$  ( $-4^{\circ}\text{F}$ ) or above  $60^{\circ}\text{C}$  ( $140^{\circ}\text{F}$ ). This could damage the equipment. The equipment should be in a controlled environment.
15. **CAUTION:** Danger of explosion if battery is incorrectly replaced. Replace only with the same or equivalent type recommended by the manufacturer, discard used batteries according to the manufacturer's instructions.
16. The sound pressure level at the operator's position according to IEC 704-1:1982 is no more than 70 dB (A).
17. **RESTRICTED ACCESS AREA:** The equipment should only be installed in a Restricted Access Area.
18. **DISCLAIMER:** This set of instructions is given according to IEC 704-1. Advantech disclaims all responsibility for the accuracy of any statements contained herein.

---

## Packing List

Before installation, please ensure the following items have been shipped:

- 1 x ARK-3202 Unit
- 2 x Desk/Wall mount plate
- 1 x 2-pin Phoenix DC power connector
- 1 x Utility CD
- 1 x Registration and 2 years Warranty card

## Ordering information

Model Number Description

ARK-3202L-S6A1E Intel® ATOM N270 1.6GHz Compact Embedded Box IPC

## Optional accessories

Part Number	Description
1757000222	ADAPTER AC 65 W DC19 V/3.42 A FSP (ARK-338X)
1700001947	Power Cable 2-pin 180 cm, USA for ARK-338X
1700009398	LVDS cable for ARK-3202

Note: \* By project option.

# Contents

<b>Chapter 1</b>	<b>General Introduction .....</b>	<b>1</b>
1.1	Introduction .....	2
1.2	Product Feature .....	2
	1.2.1 General .....	2
	1.2.2 Display .....	2
	1.2.3 Power consumption .....	2
1.3	Hardware Specification .....	3
	1.3.1 System .....	3
	1.3.2 Memory .....	3
	1.3.3 Input/Output .....	3
	1.3.4 Graphics.....	3
	1.3.5 Ethernet LAN .....	3
	1.3.6 Industrial features .....	3
1.4	Mechanical Specification.....	4
	1.4.1 Dimensions .....	4
	Figure 1.1 ARK-3202 Mechanical Dimension Drawing.....	4
	1.4.2 Weight.....	4
1.5	Power requirement.....	4
	1.5.1 System power .....	4
	1.5.2 RTC battery.....	4
1.6	Environmental Specifications .....	5
	1.6.1 Operation temperature.....	5
	1.6.2 Relative Humidity .....	5
	1.6.3 Storage temperature .....	5
	1.6.4 Vibration loading during operation .....	5
	1.6.5 Shock during operation .....	5
	1.6.6 Safety.....	5
	1.6.7 EMC .....	5
<b>Chapter 2</b>	<b>Hardware installation .....</b>	<b>7</b>
2.1	ARK-3202 I/O Indication .....	8
	Figure 2.1 ARK-3202 Front View.....	8
	Figure 2.2 ARK-3202 Rear View .....	8
2.2	ARK-3202 front side external I/O connectors.....	9
	Table 2.1: Connector Table .....	9
	Figure 2.3 PCI-7030 for ARK-3202.....	22
2.3	Memory Installation .....	24
	Figure 2.4 Memory Installation .....	24
2.4	Compact Flash installation .....	25
	Figure 2.5 CF Card installation .....	25
2.5	HDD installation .....	25
	2.5.1 Internal fixed HDD installation.....	25
	Figure 2.6 Internal Fixed HDD Installation.....	25
<b>Chapter 3</b>	<b>BIOS settings .....</b>	<b>27</b>
3.1	BIOS Introduction .....	28
3.2	BIOS Setup .....	28
	3.2.1 Main Menu .....	29
	3.2.2 Standard CMOS Features .....	30
	3.2.3 Advanced BIOS Features .....	31
	3.2.4 Advanced Chipset Features.....	32

3.2.5	Integrated Peripherals .....	34
3.2.6	USB Device Setting .....	37
3.2.7	Security Chip Configuration (Optional Item) .....	38
3.2.8	TPM Support.....	38
3.2.9	Power Management Setup .....	38
3.2.10	PnP/PCI Configurations.....	40
3.2.11	PC Health Status .....	41
3.2.12	Frequency/Voltage Control .....	42
3.2.13	Load Setup Defaults .....	43
3.2.14	Set Password.....	43
3.2.15	Save & Exit Setup.....	45
3.2.16	Quit without Saving.....	45

## **Chapter 4 Software Installation..... 47**

4.1	Chipset Driver Installation .....	48
4.1.1	Before You Begin.....	48
4.1.2	Introduction .....	48
4.1.3	Windows XP Driver Setup .....	49
4.2	VGA Driver Installation.....	50
4.2.1	Introduction .....	50
4.2.2	Windows Vista/XP/2000 .....	50
4.3	LAN Driver Installation .....	51
4.3.1	Introduction .....	51
4.3.2	Installation.....	51
4.3.3	Win XP/Vista Driver Setup.....	51
4.4	Audio Driver Installation .....	52



# Chapter 1

## General Introduction

This chapter gives background information on ARK-3202 series.

---

## 1.1 Introduction

ARK-3202 Compact Embedded Box IPC is an ideal application ready system platform solution. All electronics are protected in a compact sealed aluminum case for easy embedding in customers own housing, or as a stand-alone application, where space is limited and the environment harsh.

A solid sealed aluminum case provides vibration and dust resistance while also providing a passive cooling solution. The ARK-3202 provides system integrators with a turn-key solution and versatile application development path without breaking the bank or missing time to market deadlines.

The ARK-3202 can be used as a standalone system, wall-mounted and desktop mounted. The system accepts a wide range of power supplies (DC power in) and comes in a footprint of only 220 mm x 68 mm x 200 mm (8.66" x 2.68" x 7.87"). The rugged cast aluminum case not only provides great protection from EMI, shock/vibration, cold and heat, but also passive cooling for quiet fanless operation.

The ARK-3202 answers this demand by offering 1 x DVI-D interface for dual display, 5 x USB 2.0 ports, 2 x Giga LAN port, audio function and 2 x COM ports packed into a small rugged unit and powered by an Intel ATOM N270 processor. It also supports a wide range of input voltages from 12 VDC to 24 VDC. The ARK-3202 Compact Embedded IPC supports 1 x 2.5" SATA HDD and 1 x Compact Flash card for storage options and it can provide the diversified application field.

## 1.2 Product Feature

### 1.2.1 General

- Intel ATOM N270 Processor 1.6 GHz
- Dual display and support for wide screen with high resolution
- Support 2 GbE, 5 USB 2.0, audio and 2 COM
- Internal one 2.5-inch SATA HDD drive bay
- Easy integration, easy maintenance, and wide input voltage range

### 1.2.2 Display

- **Dual display:** CRT + DVI-D
- **LVDS support:** Support 36-bit LVDS interface (Optional)

### 1.2.3 Power consumption

- **Typical:** 13.3 W (CPU is Intel ATOM N270 Processor 1.6 GHz and w/o expansion)
- **Max.:** 17 W (CPU is Intel ATOM N270 Processor 1.6 GHz and w/o expansion)

## 1.3 Hardware Specification

### 1.3.1 System

- **CPU:** Intel® Atom. N270 1.6 GHz FSB 533 MHz
- **BIOS:** Award SPI 8 Mbit BIOS
- **System chipset:** Intel/Æ 945GSE with ICH7M
- **SATA hard disk drive interface:** One on-board SATA connectors with data transmission rate up to 150 MB
- **CF interface:** Supports compact flash Type II

### 1.3.2 Memory

- **RAM:** Up to 2 GB in 1 slots 200-pin SODIMM sockets. Supports single channel DDRII 533 SDRAM

### 1.3.3 Input/Output

- **PCI bus:** Support 32/33MHz PCI 4 Slots to backplane.
- **Serial ports:** Six serial ports, 2 x RS-232 onboard, 3 x RS-232/422/485 with auto flow control by AMO-R007 add-on card
- **Keyboard and PS/2 mouse connector:** Two 6-pin mini-DIN connectors are located on the mounting bracket for easy connection to a PS/2 keyboard and mouse
- **USB port:** 5 USB 2.0 with 480 Mbps
- **GPIO connector:** 8-bit general purpose input/output (Optional)

### 1.3.4 Graphics

- **Controller:** Chipset integrated VGA controller
- **Display memory:** Dynamically shared system memory up to 224 MB
- **CRT:** Up to 2048 x 1536 resolution, 400 MHz RAMDAC
- **LVDS:** Supports single channel 18-bit/ dual channel 36-bit LVDS, Up to UXGA 1600 x 1200
- **DVI:** Support Maximum pixel clock of 400 MHz, up to 2048 x 1536 resolutions @ 75 Hz refresh rate

### 1.3.5 Ethernet LAN

- Supporting dual 10/100/1000 Mbps Ethernet port (s) via PCI Express x1 bus which provides 500 MB/s data transmission rate
- **Controller:** Intel 82574L Chipset

### 1.3.6 Industrial features

- **Watchdog timer:** Can generate a system reset. The watchdog timer is programmable and can be set from 1 to 255 seconds or 1 to 255 minutes.

## 1.4 Mechanical Specification

### 1.4.1 Dimensions

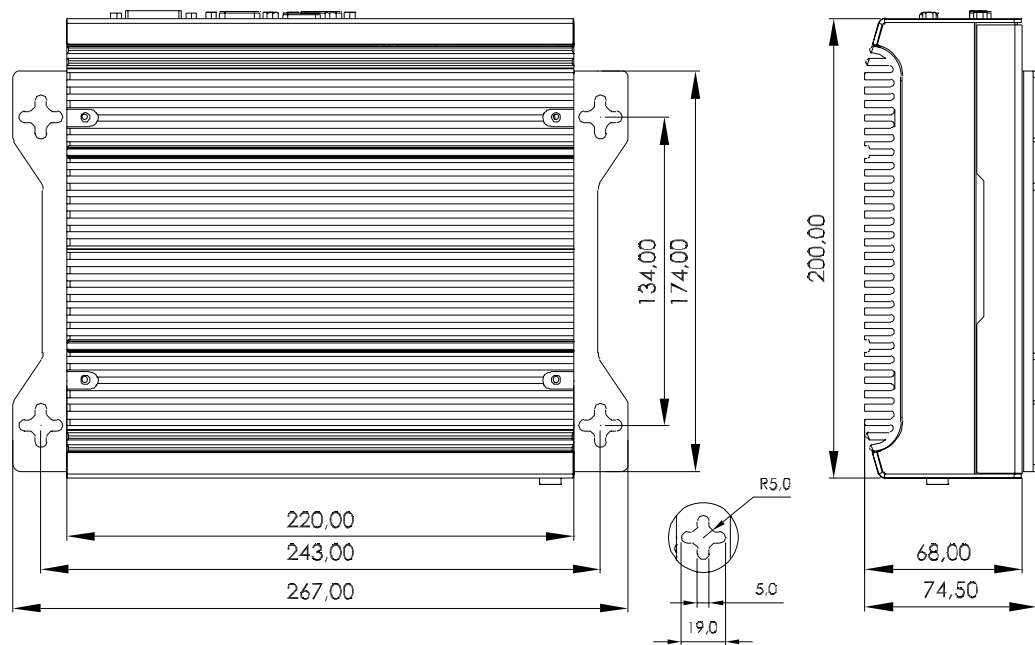

Figure 1.1 ARK-3202 Mechanical Dimension Drawing

### 1.4.2 Weight

3 kg (6.6 lb)

## 1.5 Power requirement

### 1.5.1 System power

Minimum power input: DC 12 V - 24 V, 3.0 A - 1.5 A

### 1.5.2 RTC battery

3 V / 195 mAH BR2032

## 1.6 Environmental Specifications

### 1.6.1 Operation temperature

- With Industrial Grade CompactFlash disk: 0 ~ 60° C
- With 2.5-inch extended temperature hard disk 0 ~ 45° C, with air flow, speed=0.7 m/sec

### 1.6.2 Relative Humidity

95% @ 40° C (non-condensing)

### 1.6.3 Storage temperature

-40 ~ 85° C (-40 ~ 185° F)

### 1.6.4 Vibration loading during operation

- With CompactFlash disk: 5 Grms, IEC 60068-2-64, random, 5 ~ 500 Hz, 1 Oct./min, 1 hr/axis.
- With 2.5-inch hard disk: 1 Grms, IEC 60068-2-64, random, 5 ~ 500 Hz, 1 Oct./min, 1 hr/axis.

### 1.6.5 Shock during operation

- With CompactFlash disk: 50 G, IEC 60068-2-27, half sine, 11 ms duration
- With hard disk: 20 G, IEC 60068-2-27, half sine, 11 ms duration

### 1.6.6 Safety

UL, CCC, BSMI

### 1.6.7 EMC

CE, FCC, CCC, BSMI



# Chapter 2

## Hardware installation

This chapter introduces external IO and the installation of ARK-3202 Hardware.

## 2.1 ARK-3202 I/O Indication

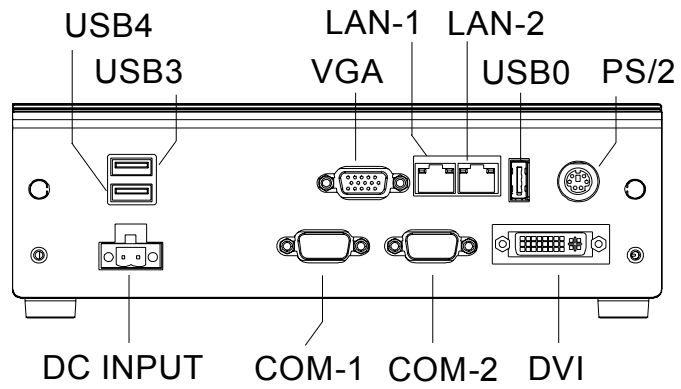

Figure 2.1 ARK-3202 Front View

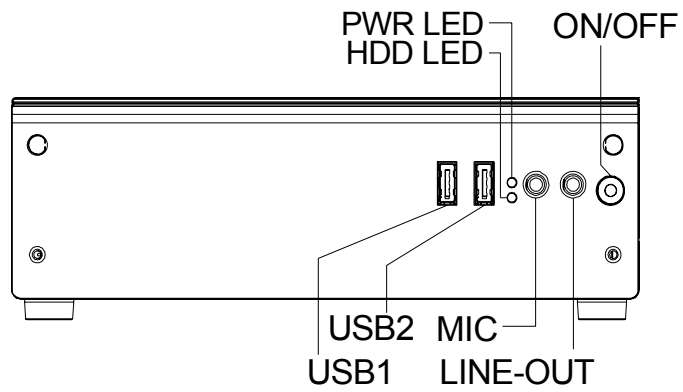

Figure 2.2 ARK-3202 Rear View



## 2.2 ARK-3202 front side external I/O connectors

**Table 2.1: Connector Table**

JFP1	Front Panel Indicate and SW Header (By Cable to AMO-0102)
COM1, 2	COM Port Header (By Cable to I/O) (or BY Cable to AMO-R007 Optional)
VGA1	VGA Port
LAN1, 2	LAN Port X 2
USB5	USB I/O Port
KBMS1	PS2 Keyboard & Mouse
USB12	USB X 2 Header (By Cable to AMO-0102)
USB34	USB X 2 Header (By Cable to I/O)
SPI1	BIOS Socket
DVI1	DVI Header (By Cable to I/O)
LVDS1	LVDS Header (By Cable to I/O Optional)
INV1	LVDS power Header (By Cable to I/O)
HDAUD1	HD AUDIO Header (By Cable to AMO-0102)
SATA1	SATA Header
DIMMA1	DDR2 Socket
ATX1	Power Header (By Cable to PCM-257)

<b>JFP1</b>	<b>Front Panel Indicate and SW Header</b>
<b>Part Number</b>	<b>1653005200</b>
<b>Package</b>	<b>PH5x2P-2.54</b>
<b>Description</b>	<b>PIN HEADER 5*2P 180D (M) 2.54 mm DIP WO/Pb</b>
<b>Pin</b>	<b>Name</b>
1	HDLED_A
2	GF_HDDLED#
3	PWRLED_A
4	PWRLED_C
5	SUSLED_A
6	SUSLED_C
7	SYS_RST#
8	GND
9	PANSWIN#_R
10	GND

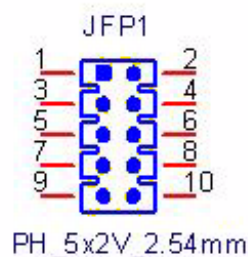

<b>COM1, COM2</b>	<b>COM Port Header</b>
<b>Part Number</b>	<b>1653210260</b>
<b>Package</b>	<b>BH10x2P-S2.00</b>
<b>Description</b>	<b>BOX HEADER 10*2P 180D(M) 2.0mm SMD W/O Pb</b>
<b>Pin</b>	<b>Name</b>
1	DCDA
2	DSRA
3	SINA
4	RTSA
5	SOUTA
6	CTSA
7	DTRA
8	RIA
9	GND
10	GND
11	DCDB
12	DSRB
13	SINB
14	RTSB
15	SOUTB
16	CTSB
17	DTRB
18	RIB
19	GND
20	GND

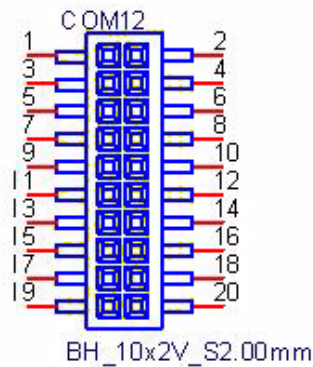

<b>VGA1</b>	<b>VGA Port</b>
<b>Part Number</b>	<b>1654515304</b>
<b>Package</b>	<b>DSUB15P</b>
<b>Description</b>	<b>D-SUB CONN. 15P 90D(F) DIP 5mm BLUE W/O Pb</b>
<b>Pin</b>	<b>Name</b>
1	CRT_R
2	CRT_G
3	CRT_B
4	NC
5	GND_VGA
6	CRT_FOC_ON
7	GND_VGA
8	GND_VGA
9	+V5_VGA
10	GND_VGA
11	NC
12	CRT_DDAT
13	CRT_HSYNC
14	CRT_VSYNC
15	CRT_DCLK
16	GND_F
17	GND_F

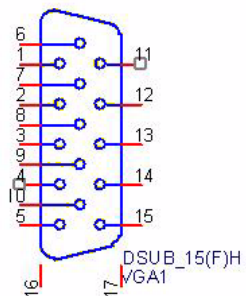

<b>LAN1, LAN2</b>	<b>LAN Port X 2</b>
<b>Part Number</b>	<b>1652003274</b>
<b>Package</b>	<b>RJ45-2x1+FMR</b>
<b>Description</b>	<b>PHONE JACK RJ45 28P DIP Gold flash RTB-19GB9J1A</b>
<b>Pin</b>	<b>Net Name</b>
A1	LAN1_MDI0+
A2	LAN1_MDI0-
A3	LAN1_MDI1+
A4	LAN1_MDI1-
A5	LAN1_1P8R
A6	TCT1
A7	LAN1_MDI2+
A8	LAN1_MDI2-
A9	LAN1_MDI3+
A10	LAN1_MDI3-
A11	LAN1_LED1_R
A12	+V3.3_LAN1
A13	LAN1_LINK1000#
A14	LAN1_LINK100#
B1	LAN2_MDI0+
B2	LAN2_MDI0-
B3	LAN2_MDI1+
B4	LAN2_MDI1-
B5	LAN2_1P8R
B6	TCT2
B7	LAN2_MDI2+
B8	LAN2_MDI2-
B9	LAN2_MDI3+
B10	LAN2_MDI3-
B11	LAN1_LED2
B12	+V3.3_LAN2
B13	LAN2_LINK1000#
B14	LAN2_LINK100#
H1	NC
H2	NC
H3	GND_F
H4	GND_F

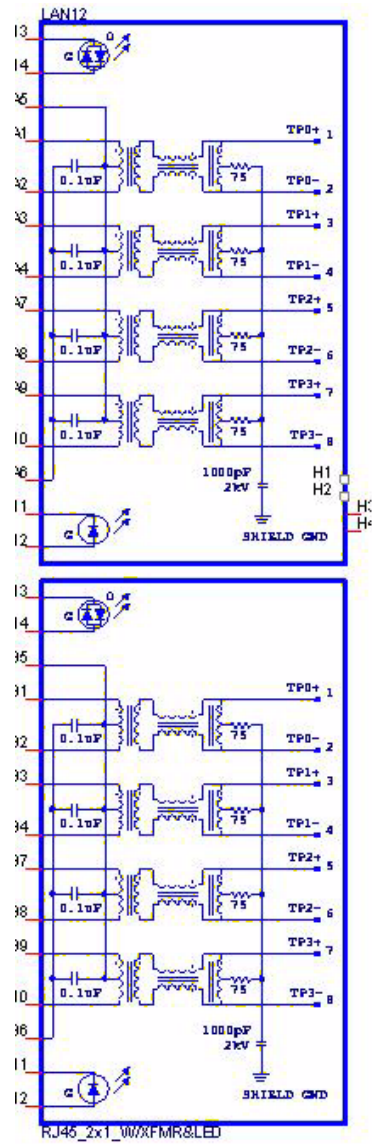

<b>USB5</b>	<b>USB I/O Port</b>
<b>Part Number</b>	<b>1654904105</b>
<b>Package</b>	<b>USB4P</b>
<b>Description</b>	<b>USB CON. 4P 90D(F) DIP A TYPE RoHS</b>
<b>Pin</b>	<b>Name</b>
1	USBV2
3	USBP4+
2	USBP4-
4	GND
5	GND_F
6	GND_F
7	GND_F

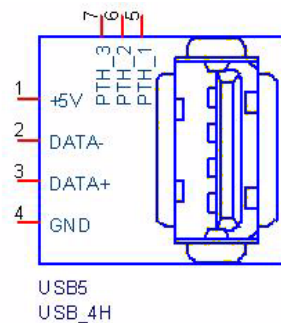

<b>KBMS1</b>	<b>PS2 Keyboard &amp; Mouse</b>
<b>Part Number</b>	<b>1654003199</b>
<b>Package</b>	<b>MINIDIN6P</b>
<b>Description</b>	<b>MINIDIN 6P Short body W/Shielding90D(F) DIP</b>
<b>Number</b>	<b>Net Name</b>
1	R_KDAT
2	R_MDAT
3	GND
4	VCC_M
5	R_KCLK
6	R_MCLK
7	GND_F
8	GND_F
9	GND_F

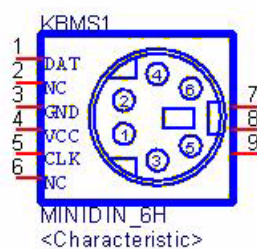

<b>USB1, 2 and USB3, 4</b>	<b>USB X 2 Header</b>
<b>Part Number</b>	<b>1655002182</b>
<b>Package</b>	<b>WB10P-2.0</b>
<b>Description</b>	<b>Wafer box conn. DIP 2*5P 180D(M) 2.0mm NO.10P</b>
<b>Pin</b>	<b>Name</b>
1	USBV0
2	USBV0
3	USBD0-
4	USBD1-
5	USBD0+
6	USBD1+
7	GND
8	GND
9	FGND

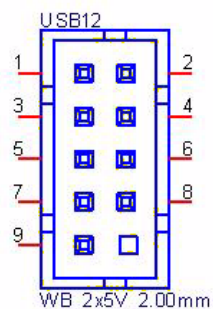

<b>SPI1</b>	<b>BIOS Socket</b>
<b>Part Number</b>	<b>1651000682</b>
<b>Package</b>	<b>IC SKT8P</b>
<b>Description</b>	<b>IC SKT 8P SMD WO/Pb C ACA-SPI-004-K01</b>
<b>Pin</b>	<b>Name</b>
1	SPI_CS#
2	SPI_MISO
3	SPI_WP#
4	GND
5	SPI_MOSI
6	SPI_CLK
7	SPI_HD#
8	+V3.3_SPI

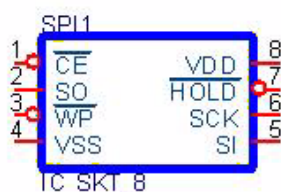

<b>DVI1</b>	<b>DVI Header</b>
<b>Part Number</b>	<b>1653910261</b>
<b>Package</b>	<b>DF13-20P-S1.25</b>
<b>Description</b>	<b>*CONN. SMD 10*2P 180D(M)DF13-20DP-1.25V(54) HRS</b>
<b>Pin</b>	<b>Name</b>
1	TDC0-
2	+V5_TMDS
3	TDC0+
4	TLC-
5	GND
6	TLC+
7	TDC1-
8	GND
9	TDC1+
10	SC_DDC
11	GND
12	SD_DDC
13	TDC2-
14	HPDETT
15	TDC2+
16	NC
17	+V5_TMDS
18	NC
19	NC
20	NC
21	NC
22	NC
23	NC
24	NC

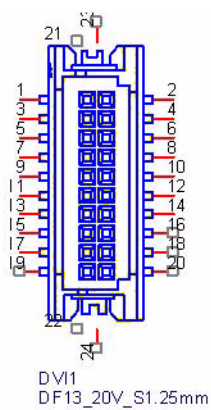



<b>LVDS1</b>	<b>LVDS Header</b>
<b>Part Number</b>	<b>1653920200</b>
<b>Package</b>	<b>DF13-40P-S1.25</b>
<b>Description</b>	<b>*CONN. 40P 90D 1.25mm SMD WO/Pb DF13-40DP-1.25V</b>
<b>Number</b>	<b>Net Name</b>
1	+V_LCD
2	+V_LCD
3	GND
4	GND
5	+V_LCD
6	+V_LCD
7	LVDS0_D0-
8	LVDS1_D0-
9	LVDS0_D0+
10	LVDS1_D0+
11	GND
12	GND
13	LVDS0_D1-
14	LVDS1_D1-
15	LVDS0_D1+
16	LVDS1_D1+
17	GND
18	GND
19	LVDS0_D2-
20	LVDS1_D2-
21	LVDS0_D2+
22	LVDS1_D2+
23	GND
24	GND
25	LVDS0_CLK-
26	LVDS1_CLK-
27	LVDS0_CLK+
28	LVDS1_CLK+
29	GND
30	GND
31	LVDS0_DDC_SC
32	LVDS0_DDC_SD
33	GND
34	GND
35	NC
36	NC
37	NC
38	NC
39	NC
40	NC
41	NC

42	NC
43	NC
44	NC

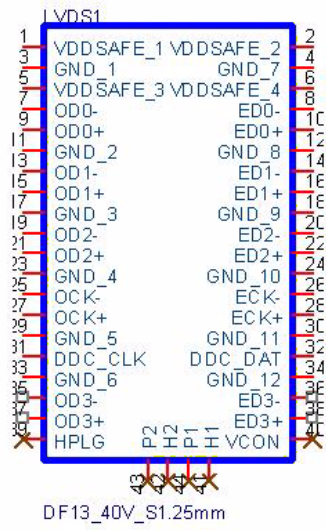

<b>INV1</b>	<b>LVDS power Header</b>
<b>Part Number</b>	<b>1655305020</b>
<b>Package</b>	<b>WB5P-2.00</b>
<b>Description</b>	<b>WAFER BOX 2.0mm 5P 180D(M) W/LOCK</b>
<b>Pin</b>	<b>Name</b>
1	+V12_INV1
2	GND
3	LVDS0_a_ENABKL
4	VBR
5	+V5_INV1

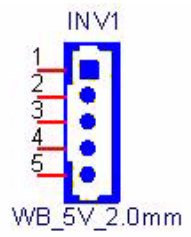

<b>HDAUD1</b>	<b>HD AUDIO Header</b>
<b>Part Number</b>	<b>1653006204</b>
<b>Package</b>	<b>PH6x2P-2.00</b>
<b>Description</b>	<b>PIN HEADER 6*2P 180D(M) 2.0mm DIP NO.12P</b>
<b>Pin</b>	<b>Name</b>
1	+V5_Audio
2	GND
3	AZ_SYNC
4	AZ_BITCLK
5	AZ_SDOUT
6	AZ_SDIN0_R
7	AZ_SDIN1_R
8	AZ_RST#
9	+V12_Audio
10	GND
11	GND

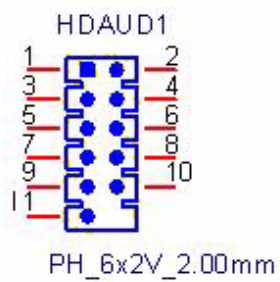

<b>SATA1</b>	<b>SATA Header</b>
<b>Part Number</b>	<b>1654004659</b>
<b>Package</b>	<b>SATA7P</b>
<b>Description</b>	<b>Serial ATA Con 7p 180D(M)DIP 1.27mm WO/Pb(L=3.3)</b>
<b>Pin</b>	<b>Name</b>
1	GND
2	SATA0_TX+
3	SATA0_TX-
4	GND
5	SATA0RX_N
6	SATA0RX_P
7	GND
8	NC
9	NC

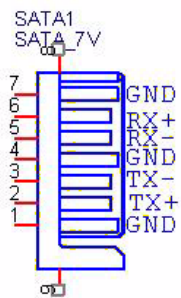

<b>DIMMA1</b>	<b>SODIMM DDR2 Socket</b>
<b>Part Number</b>	<b>1651000087</b>
<b>Footprint</b>	<b>SODIMM200P</b>
<b>Description</b>	<b>SKT DIMM 200P DDR2 H=6.5mm STD SMD WO/Pb</b>

<b>ATX1</b>	<b>ATX Power Header</b>
<b>Part Number</b>	<b>1655412110</b>
<b>Package</b>	<b>ATX6x2P-R4.20</b>
<b>Description</b>	<b>WAFER 2*6P 4.2mm 90D(M) W/LOCK 4200-WR-A1</b>
<b>Number</b>	<b>Net Name</b>
1	GND
2	+V5
3	+V5
4	GND
5	+V5
6	+V5
7	GND
8	GND
9	+V5SB
10	PSION_SIO#
11	GND
12	+V12

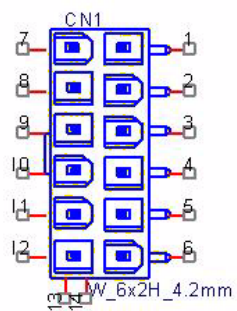

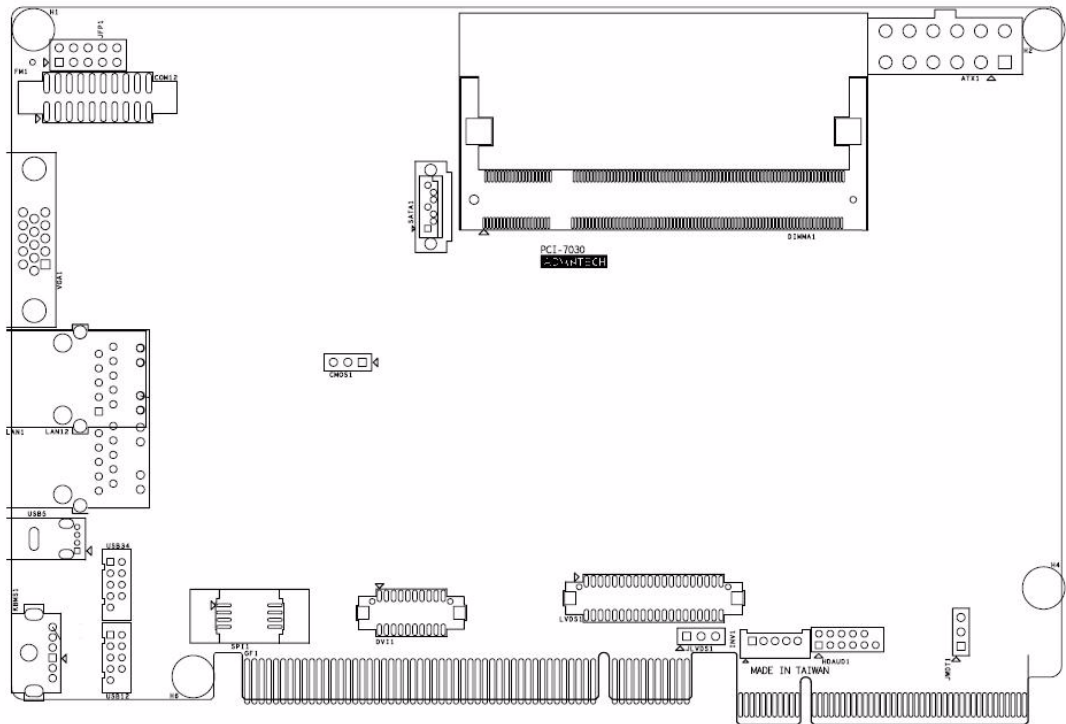

**Figure 2.3 PCI-7030 for ARK-3202**

**Jumper Setting**

CMOS1	Clear CMOS Setting
JLVDS1	LVDS Voltage Setting
JWDT1	Watch Dog Setting

**CMOS1 Clear CMOS Setting**

<b>Part Number</b>	<b>1653003100</b>
<b>Package</b>	<b>PH3x1P-2.54</b>
<b>Description</b>	<b>PIN HEADER 3*1P 180D(M) 2.54mm DIP WO/Pb</b>

<b>Setting</b>	<b>Function</b>
1-2	Normal (Default)
2-3	Clear

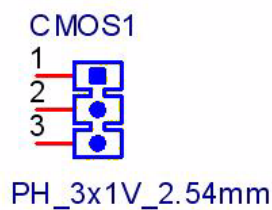

<b>JLVDS1</b>	<b>LVDS Voltage Setting</b>
<b>Part Number</b>	<b>1653003100</b>
<b>Package</b>	<b>PH3x1P-2.54</b>
<b>Description</b>	<b>PIN HEADER 3*1P 180D(M) 2.54mm DIP WO/Pb</b>
<b>Setting</b>	<b>Function</b>
1-2	3.3 V (Default)
2-3	5 V

PH\_3x1V\_2.54mm  
JLVDS1

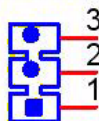

<b>JWDT1</b>	<b>Watch Dog Setting</b>
<b>Part Number</b>	<b>1653003100</b>
<b>Package</b>	<b>PH3x1P-2.54</b>
<b>Description</b>	<b>PIN HEADER 3*1P 180D(M) 2.54mm DIP WO/Pb</b>
<b>Setting</b>	<b>Function</b>
1-2	By South Bridge
2-3	By SIO (Default)

JWDT1

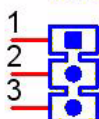

NL/PH\_3x1V\_2.54mm

## 2.3 Memory Installation

Step 1: Remove the Heatsink by loosen the fixing screws.

Step 2: Remove the heatspreader by unscrew the 4 screws.

Step 3: Insert the memory module into the SODIMM socket.

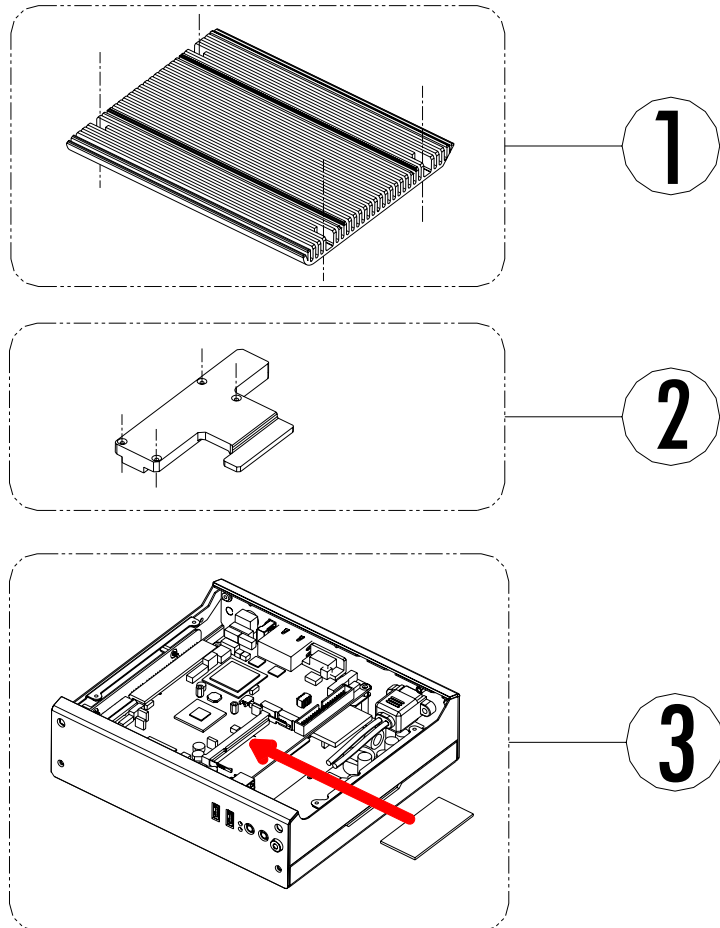

Figure 2.4 Memory Installation



## 2.4 Compact Flash installation

step 1: Remove the bottom cover by unscrew 4 screws.

Step 2: Unscrew CF bracket and install compact Flash.

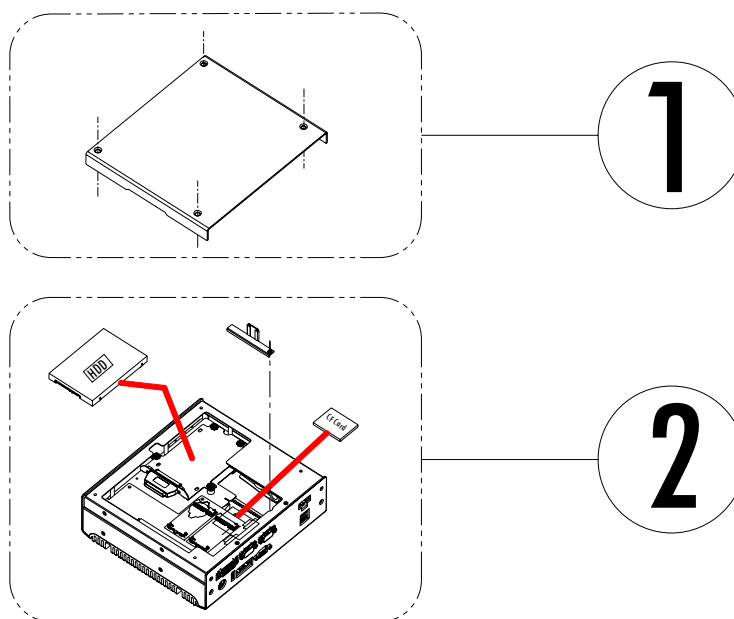

Figure 2.5 CF Card installation

## 2.5 HDD installation

### 2.5.1 Internal fixed HDD installation

Step 1: Remove the bottom cover by unscrew the 4 screws.

Step 2: Install the 2.5-inch SATA HDD by 4 HDD screws.

Step 3: Connect the SATA signal cable and power cable with the fixing 2.5-inch HDD.

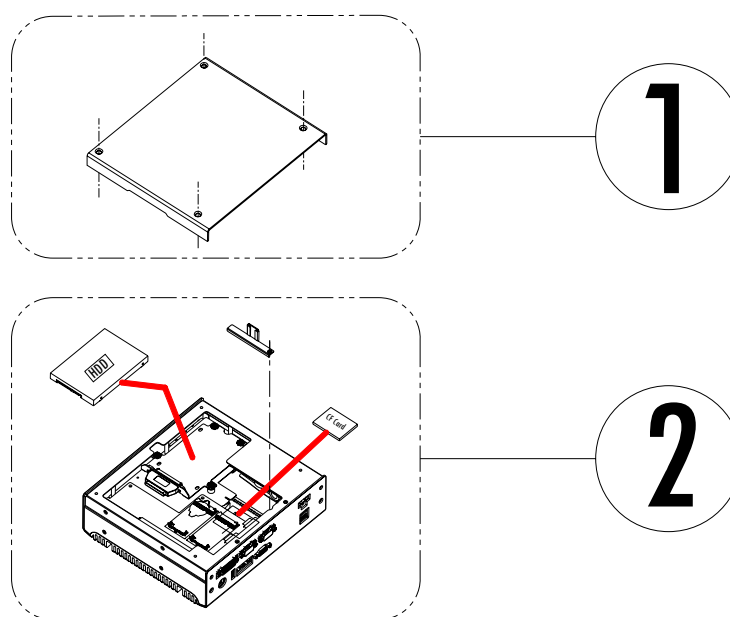

Figure 2.6 Internal Fixed HDD Installation



# Chapter 3

## BIOS settings

This chapter introduces how to set BIOS configuration data.

## 3.1 BIOS Introduction

Advantech provides full-featured AwardBIOS 6.0 and delivers the superior performance, compatibility and functionality that system integrators demand.

The modular, adaptable AwardBIOS 6.0 supports the broadest range of third-party peripherals and all popular chipsets, plus Intel, AMD, nVidia, VIA, and compatible CPUs from 386 through Pentium and AMD Geode, K7 and K8 (including multiple processor platforms), and VIA Eden C3 and C7 CPU.

You can use Advantech's utilities to select and install features as needed.

## 3.2 BIOS Setup

The ARK-3202 series system has build-in AwardBIOS with a CMOS SETUP utility which allows user to configure required settings or to activate certain system features.

The CMOS SETUP saves the configuration in the CMOS RAM of the motherboard. When the power is turned off, the battery on the board supplies the necessary power to the CMOS RAM.

When the power is turned on, press the <Del> button during the BIOS POST (Power-On Self Test) will take you to the CMOS SETUP screen.

---

### CONTROL KEYS

---

< ↑ >< ↓ >< ← >< → >	Move to highlight item
----------------------	------------------------

---

<Enter>	Select Item
---------	-------------

---

<Esc>	Main Menu - Quit and not save changes into CMOS
-------	---

---

<Esc>	Sub Menu - Exit current page and return to Main Menu
-------	--

---

<Page Up/+>	Increase the numeric value or make changes
-------------	--

---

<Page Down/->	Decrease the numeric value or make changes
---------------	--

---

<F1>	General help, for Setup Sub Menu
------	----------------------------------

---

<F2>	Item Help
------	-----------

---

<F5>	Load Previous Values
------	----------------------

---

<F7>	Load Optimized Default
------	------------------------

---

<F10>	Save all CMOS changes
-------	-----------------------

---

### 3.2.1 Main Menu

Press <Del> to enter AwardBIOS CMOS Setup Utility, the Main Menu will appear on the screen. Use arrow keys to select among the items and press <Enter> to accept or enter the sub-menu.

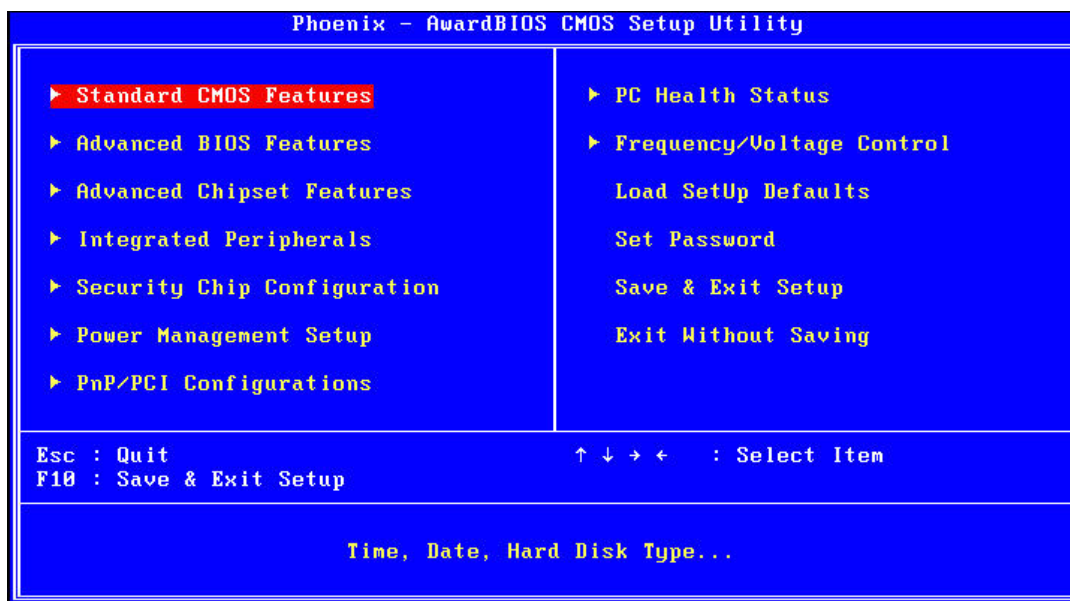

- **Standard CMOS Features**  
This setup page includes all the items in standard compatible BIOS.
- **Advanced BIOS Features**  
This setup page includes all the items of Award BIOS enhanced features.
- **Advanced Chipset Features**  
This setup page includes all the items of Chipset configuration features.
- **Integrated Peripherals**  
This setup page includes all onboard peripheral devices.
- **Security chip configuration**  
This SETUP page includes all the items of Trusted Module Configuration features. This sub-menu item only appears when the Trusted Module is plugged in.
- **Power Management Setup**  
This setup page includes all the items of Power Management features.
- **PnP/PCI Configurations**  
This setup page includes PnP OS and PCI device configuration.
- **PC Health Status**  
This setup page includes the system auto detect CPU and system temperature, voltage, fan speed.
- **Frequency/Voltage Control**  
This setup page includes CPU host clock control, frequency ratio and voltage.
- **Load Setup Defaults**  
This setup page includes Load system optimized value, and the system would be in best performance configuration.
- **Set Password**  
Establish, change or disable password.

- **Save & Exit Setup**  
Save CMOS value settings to CMOS and exit BIOS setup.
- **Exit Without Saving**  
Abandon all CMOS value changes and exit BIOS setup.

### 3.2.2 Standard CMOS Features

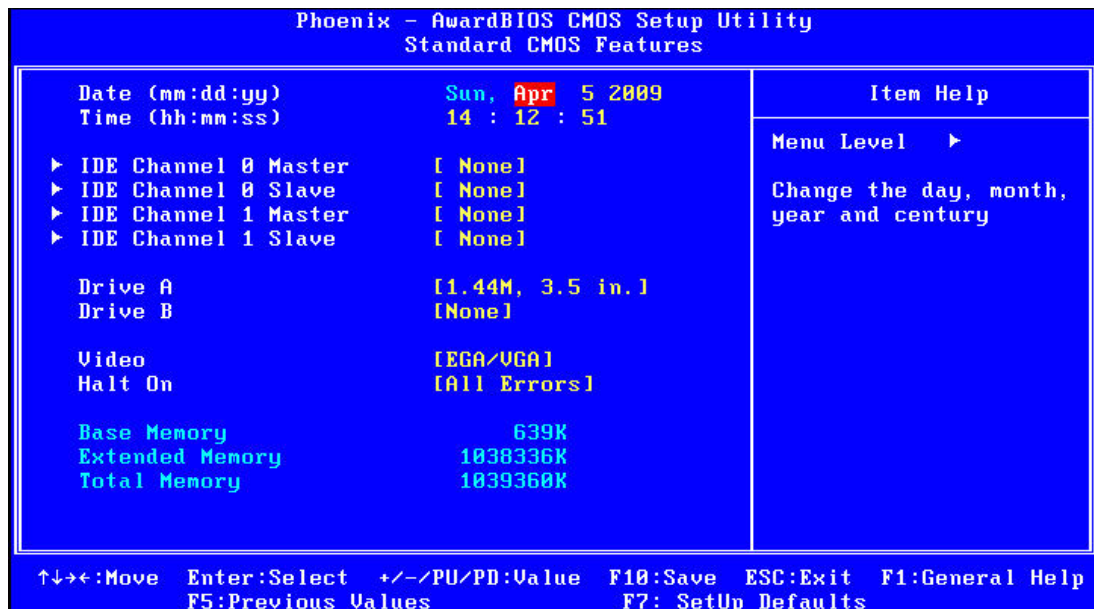

- **Date**  
The date format is <weekday>, <month>, <day>, <year>.  

Weekday	From Sun to Sat, determined and displayed by BIOS only
Month	From Jan. to Dec.
Day	From 1 to 31
Year	From 1999 through 2098
- **Time**  
The time format is <hour> <minute> <second>, based on 24-hour time.
- **IDE Channel 0 Master/Slave**  
IDE HDD Auto-Detection Press "Enter" for automatic device detection.
- **Video**  
Select EGA or VGA display.
- **Halt on**  
The item determines whether the computer will stop if an error is detected during power up.  

No Errors	The system boot will not stop for any error.
All Errors	Whenever the BIOS detects a non-fatal error the system will be stopped.
All, But Keyboard	The system boot will not stop for a keyboard error; it will stop for all other errors. (Default value)
- **Base Memory**  
The POST of the BIOS will determine the amount of base (or conventional) memory installed in the system.
- **Extended Memory**

The BIOS POST will determine the amount of extended memory (above 1 MB in CPU's memory address map) installed in the system.

- **Total Memory**

This item displays the total system memory size.

### 3.2.3 Advanced BIOS Features

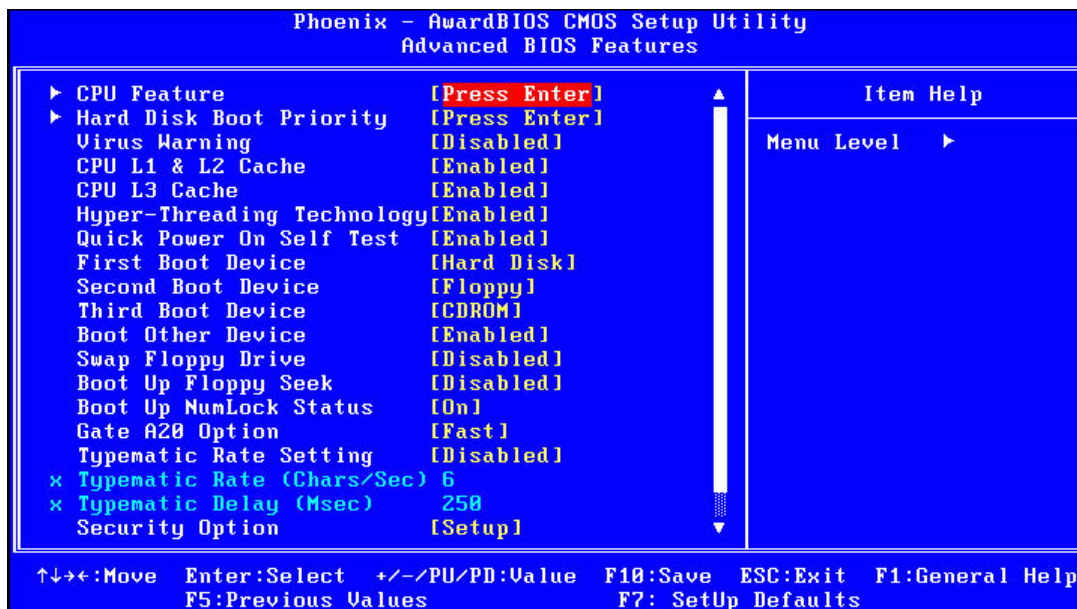

- **CPU Feature**

This item allows users to adjust CPU features.

- **Hard Disk Boot Priority**

This item allows users to select boot sequence for system device HDD, USB-HDD, SCSI, RAID.

- **Virus Warning [Disabled]**

Enables or disables the virus warning.

- **CPU L1 & L2 Cache [Enabled]**

This item allows users to enable CPU L1 and L2 cache.

- **CPU L3 Cache**

This item allows users to enable CPU L3 cache.

- **Hyper-Threading Technology**

While using a CPU with Hyper-Threading technology, you can select "Enabled" to enable Hyper-Threading Technology in an OS which supports Hyper-Threading Technology or select "Disabled" for other OSs which do not support Hyper-Threading technology.

- **Quick Power On Self Test [Enabled]**

This field speeds up the Power-On Self Test (POST) routine by skipping retesting a second, third and fourth time. Setup setting default is enabled.

- **First / Second / Third / Other Boot Drive**

Hard Disk	Select boot device priority by Hard Disk.
CDROM	Select boot device priority by CDROM.
USB-FDD	Select boot device priority by USB-FDD.
USB-ZIP	Select boot device priority by USB-ZIP.
USB-CDROM	Select boot device priority by USB-CDROM.

- LAN Select boot device priority by LAN.
- Disabled Disable this boot function.

■ **Gate A20 Option [Fast]**

This item enables users to switch A20 control by port 92 or not.

■ **Typematic Rate Setting**

This item enables users to set the two typematic controls items.

- Typematic Rate (Chars/Sec)

This item controls the speed at which the system registers auto-repeated key-strokes. The eight settings are 6, 8, 10, 12, 15, 20, 24 and 30.

- Typematic Delay (Msec)

This item sets the keypress time delay before autorepeat begins.

Four delay rate options are 250, 500, 750 and 1000.

■ **Security Option [Setup]**

- System System will not boot and refuses access to Setup page if the correct password is not entered at the prompt.
- Setup System will boot, but access to Setup requires password (default value).

■ **APIC Mode [Enabled]**

This item allows user to enabled of disabled “Advanced Programmable Interrupt Controller”. APIC is implemented in the motherboard and must be supported by the operating system, and it extends the number of IRQ's available.

### 3.2.4 Advanced Chipset Features

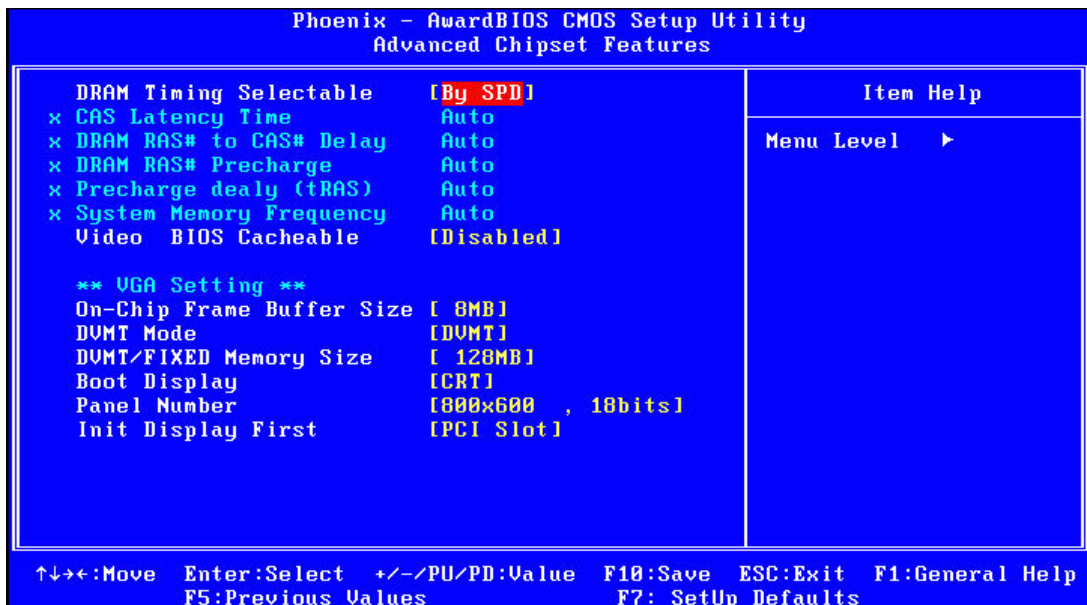

**Note!** This “Advanced Chipset Features” page controls configuration of the board’s chipset. This page is chipset dependent; screens may differ somewhat depending on the chipset. It is strongly recommended that only technical users make changes to the default settings.



- **DRAM Timing Selectable [By SPD]**

This item enables users to set the optimal timings for items 2 through 5; system default setting “By SPD” follows the SPD information and ensures the system runs stably with optimal performance.
- **CAS Latency Time [Auto]**

This item enables users to set the timing delay in clock cycles before SDRAM starts a read command after receiving it.
- **DRAM RAS# to CAS# Delay [Auto]**

This item enables users to set the timing of the transition from RAS (row address strobe) to CAS (column address strobe) as both rows and column are separately addressed shortly after DRAM is refreshed.
- **DRAM RAS# Precharge [Auto]**

This item enables users to set the DRAM RAS# precharge timing, system default is setting to “Auto” to reference the data from SPD ROM.
- **Precharge delay (tRAS) [Auto]**

This item allows user to adjust memory precharge time.
- **Video BIOS Cacheable [Disabled]**

This item allows the video BIOS to be cached to allow faster execution and better performance.
- **On-Chip Frame Buffer Size [8 MB]**

This item allows the user to adjust the on-chip frame buffer size 8 MB or 1 MB.
- **DVMT Mode [DVMT]**

This item allows the user to adjust Intel's Dynamic Video Memory Technology (DVMT). BIOS provides three options: DVMT, FIXED, and Both.
- **DVMT/FIXED Memory Size [128MB]**

This item allows the user to adjust DVMT/FIXED graphics memory size.
- **Boot Display**

This item allows the user to decide boot display mode.
- **Panel Number**

This item allows the user to decide display resolution.
- **Init Display First**

This item is the setting for start up video output: either from PCI Express or Onboard device.

## 3.2.5 Integrated Peripherals

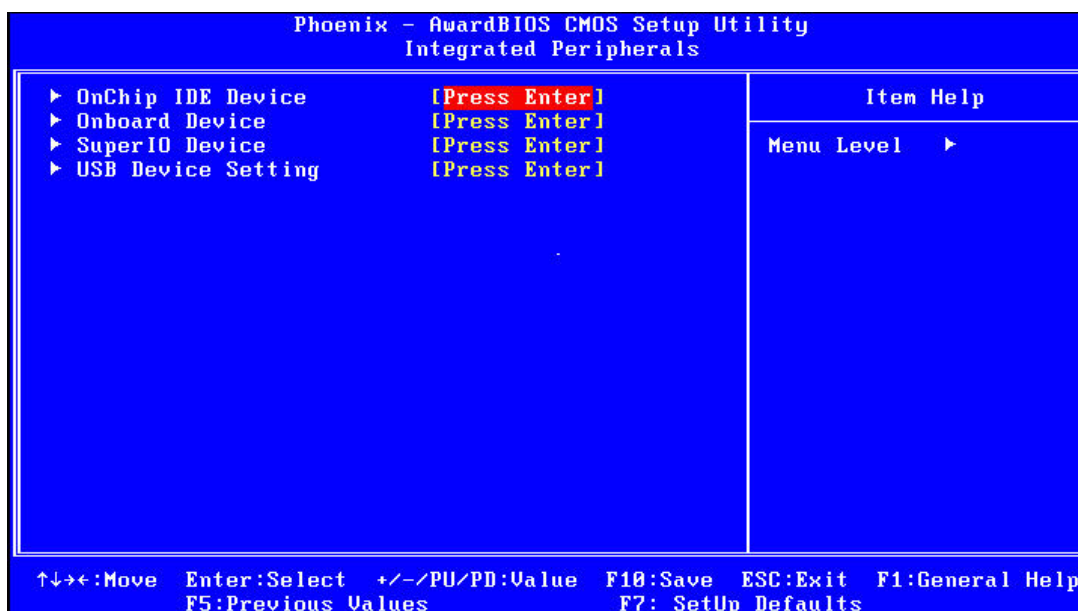

**Note!**  This "Integrated Peripherals" page controls the configuration of the board's chipset, including IDE, ATA, SATA, USB, AC97, MC97 and Super IO and Sensor devices. This page is chipset dependent; the screen capture above is illustrative, but screens do differ depending on chipset features.

### ■ OnChip IDE Device

This item enables users to set the OnChip IDE device status, including some of new chipsets also support SATA devices (Serial-ATA).

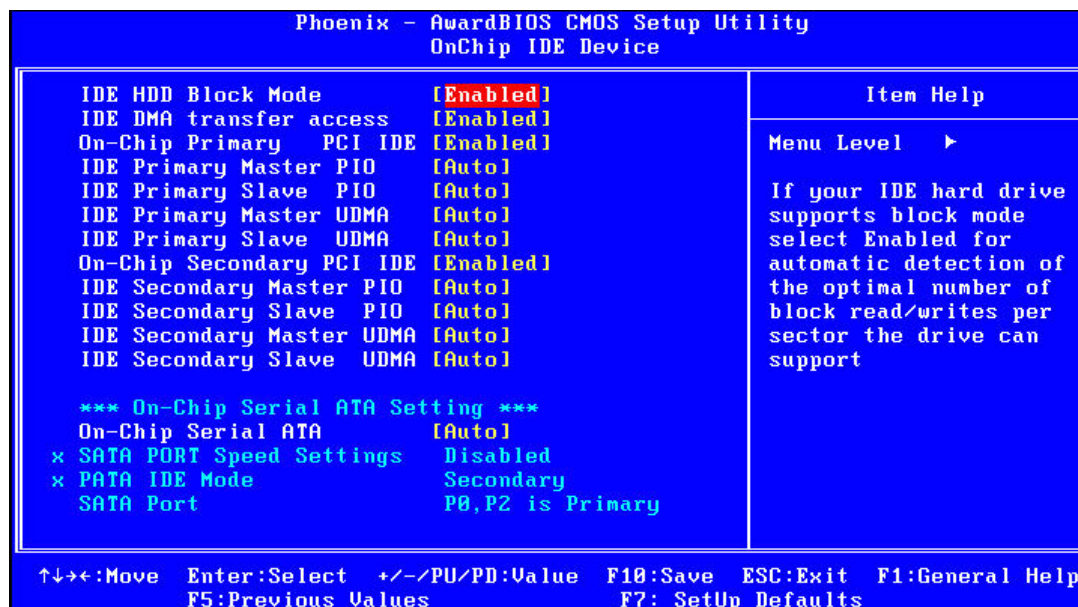

### ■ Onboard Device

This item enables users to set the Onboard device status, including enabling AC97, and LAN devices.

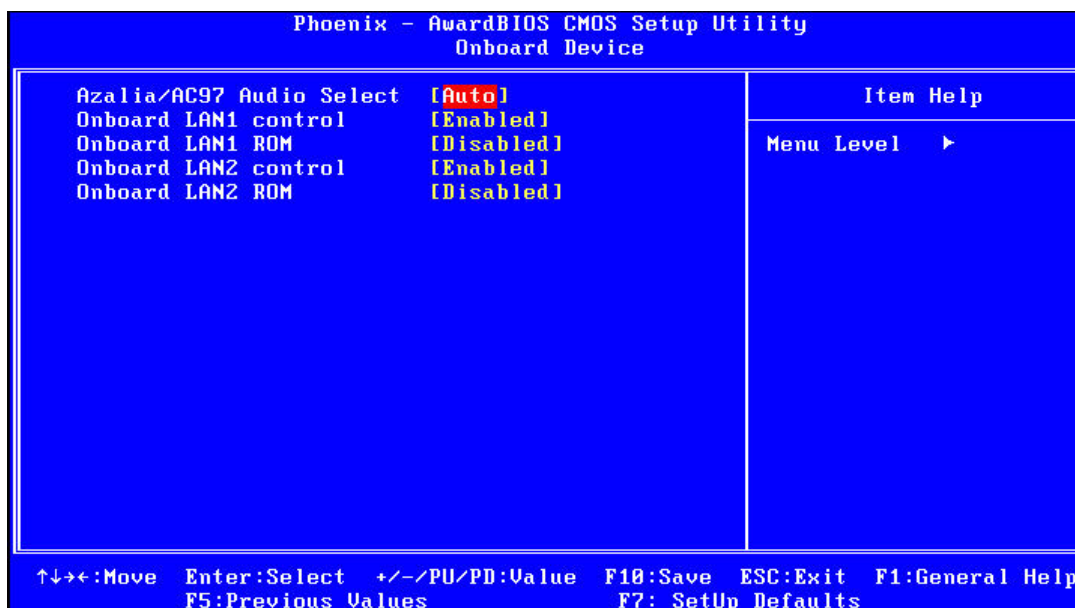

### ■ Super IO Device

This item enables users to set the Super IO device status, including enabling of COM, and LPT.

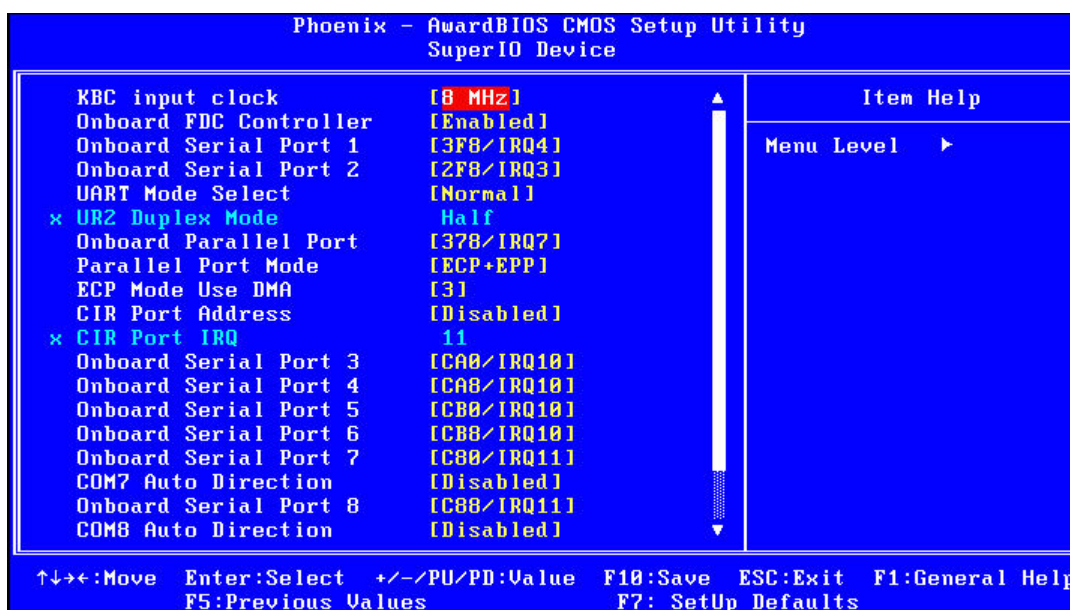

### ■ KKB input clock [8 MHz]

PS/2 keyboard communicates with the keyboard controller. The speed of the data link depends on the clock signal generated by the keyboard controller.

### ■ Onboard FDC Controller [Enable]

When enabled, this field allows you to connect your floppy disk drives to the onboard floppy disk drive connector instead of a separate controller card. If you want to use a different controller card to connect the floppy disk drives, set this field to Disabled.

- 
- **Onboard Serial port 1 [3F8 / IRQ4]**  
This item allows user to adjust serial port 1 of address and IRQ.
  - **Onboard Serial port 2 [2F8/ IRQ3]**  
This item allows user to adjust serial port 2 of address and IRQ.
  - **UART Mode select [Normal]**  
This item allows you to select UART mode.
  - **Onboard Parallel Port [378/IRQ7]**  
This item allows user to adjust parallel port of address and IRQ.
  - **Parallel Port Mode [ECP+EPP]**  
This item allows user to adjust parallel port mode.
  - **ECP Mode Use DMA [3]**  
This item allows user to adjust ECP DMA resource.
  - **CIR Port Address [Disable]**  
This item allows user to adjust CIR port of address and IRQ.
  - **Onboard Serial port 3 [CA0/IRQ10]**  
This item allows user to adjust serial port 3 of address and IRQ.
  - **Onboard Serial port 4 [CA8/IRQ10]**  
This item allows user to adjust serial port 4 of address and IRQ.
  - **Onboard Serial port 5 [CB8/IRQ10]**  
This item allows user to adjust serial port 5 of address and IRQ.
  - **Onboard Serial port 6 [CB8/IRQ10]**  
This item allows user to adjust serial port 6 of address and IRQ.
  - **Onboard Serial port 7 [C80/IRQ11]**  
This item allows user to adjust serial port 7 of address and IRQ.  
This serial port 7 need to be provided by LPC module (optional)
  - **COM7 Auto Direction [Disable]**  
This item allows user to enable Auto-Flow control function of COM7 if supported.
  - **Onboard Serial port 8 [C88/IRQ11]**  
This item allows user to adjust serial port 8 of address and IRQ.  
This serial port 8 need to be provided by LPC module (optional)
  - **COM8 Auto Direction [Disable]**  
This item allows user to enable Auto-Flow control function of COM8 if supported.
  - **Onboard Serial port 9 [C90/IRQ11]**  
This item allows user to adjust serial port 9 of address and IRQ.  
This serial port 9 need to be provided by LPC module (optional)
  - **COM9 Auto Direction [Disable]**  
This item allows user to enable Auto-Flow control function of COM9 if supported.
  - **Onboard Serial port 10 [C98/IRQ11]**  
This item allows user to adjust serial port 10 of address and IRQ.  
This serial port 10 need to be provided by LPC module (optional)
  - **COM10 Auto Direction [Disable]**  
This item allows user to enable Auto-Flow control function of COM10 if supported.

### 3.2.6 USB Device Setting

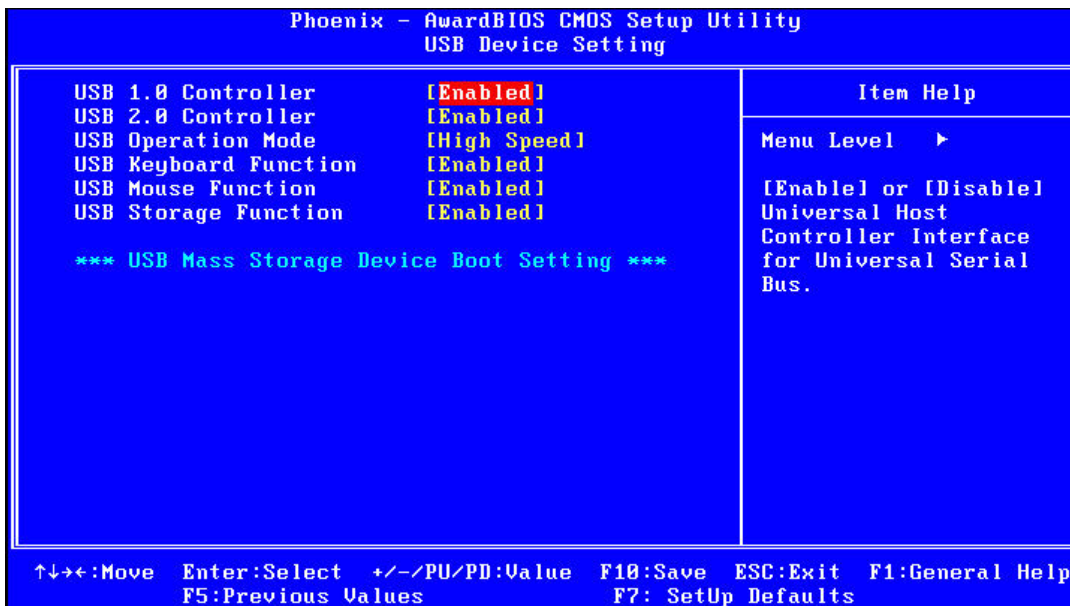

- **USB 1.0 Controller**  
 Select Enabled. if your system contains a Universal Serial Bus (USB) controller and you have USB peripherals. The choices are "Enabled" and "Disabled".
- **USB 2.0 Controller**  
 This entry is used to disable/enable the USB 2.0 controller only. The BIOS itself may or may not have high-speed USB support. If the BIOS has high speed USB support built in, the support will automatically turn on when a high speed device is attached. The choices are "Enabled" or "Disabled".
- **USB Operation Mode**  
 Set the USB 2.0 controller to Hi Speed (480 Mbps) or Full Speed (12 Mbps).
- **USB Keyboard / Mouse Function**  
 Select "Enabled" if you plan to use a USB keyboard/Mouse. The choices are "Enabled" and "Disabled".
- **USB Storage Function**  
 Select "Enabled" if you plan to use an external USB storage device to boot system under DOS mode. The choices are "Enabled" and "Disabled".

### 3.2.7 Security Chip Configuration (Optional Item)

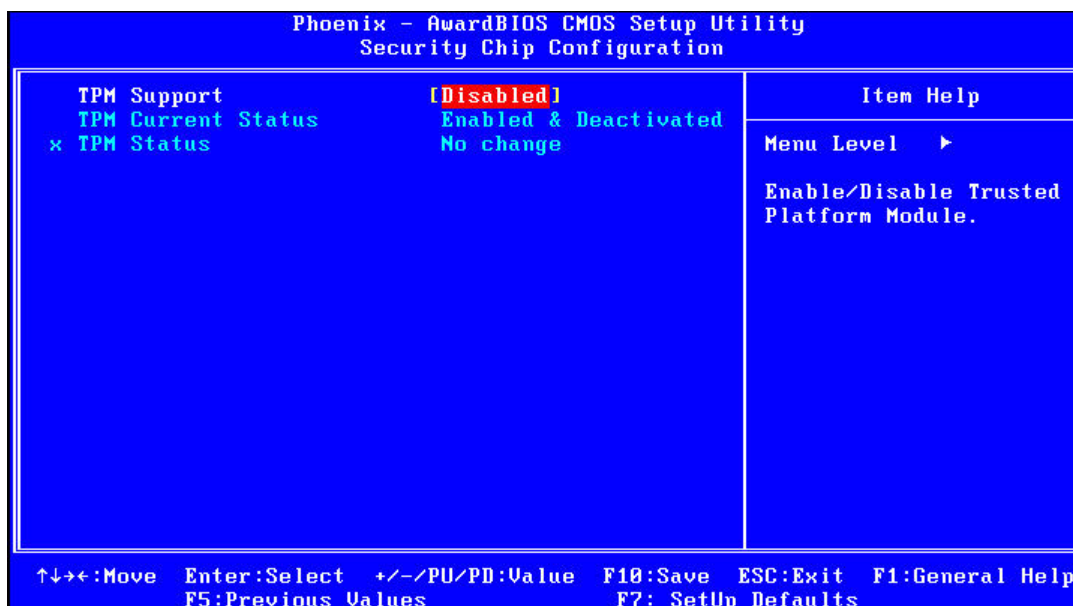

### 3.2.8 TPM Support

The items in this menu allow you to set the TPM (Trusted Platform Module) features. Select an item and then press <Enabled> to display the configuration options.

**Note!** To enable the TPM function, set the TPM Support item to [Enabled] and then save the change; after rebooting, the TPM configuration menu will show the active options.



### 3.2.9 Power Management Setup

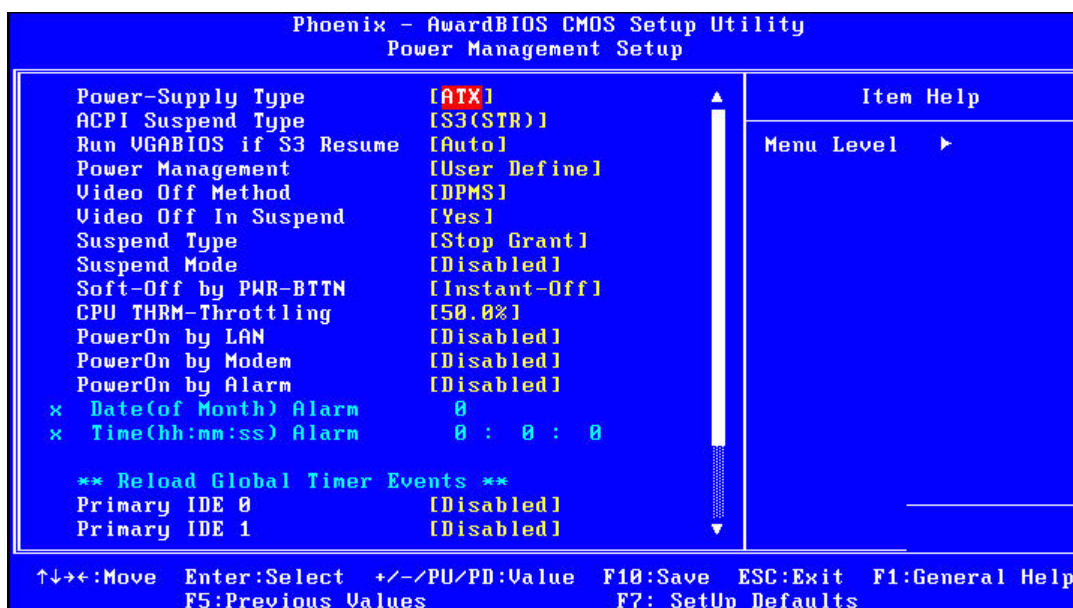

**Note!** Adjust "Power management Setup" to configure the system to most effective energy savings still consistent with the intended style of use.



- **Power-Supply Type [ATX]**  
This item allows user to set power-supply type, ATX or AT mode.
- **ACPI Suspend Type [S3(STR)]**  
This item allows user to select sleep state when in suspend.
 

S1(POS)	The suspend mode is equivalent to a software power down;
S3(STR)	The system shuts down with the exception of a refresh current to the system memory.
- **Run VGA BIOS if S3 Resume [Auto]**  
This item allows system to reinitialize VGA BIOS after system resume from ACPI S3 mode.
- **Power Management [User Define]**  
This item allows user to select system power saving mode.
 

Min Saving	Minimum power management. Suspend Mode=1 hr.
Max Saving	Maximum power management. Suspend Mode=1 min.
User Define	Allows user to set each mode individually. Suspend Mode= Disabled or 1 min ~1 hr.
- **Video Off Method [DPMS]**  
This item allows user to determine the manner in which the monitor is blanked.
 

V/H SYNC+Blank	This option will cause system to turn off vertical and horizontal synchronization ports and write blanks to the video buffer.
Blank Screen	This option only writes blanks to the video buffer.
DPMS	Initial display power management signaling.
- **Video Off In Suspend [Yes]**  
This item allows users to turn off video when system is in suspend mode.
- **Suspend Type [Stop Grant]**  
This item allows users to determine the suspend type.
- **Suspend Mode [Disabled]**  
This item allows users to set a delay time. If system inactivity exceeds the delay time, all devices except the CPU will be shut off.
- **Soft-Off by PWR-BTTN [Instant-Off]**  
This item allows users to define function of power button.
 

Instant-Off	Press power button for instant power off.
Delay 4 Sec	Press power button for four seconds to initiate power off.
- **CPU THRM-Throttling**  
The ability is control how much percent of your CPU's clock speed will be throttled down when the CPU overheat. You can set "75.0%", "50.0%", and "25.0%".
- **PowerOn by LAN [Enabled]**  
This item allows users to power on the system via LAN. The choices are "Enabled" and "Disabled".
- **PowerOn by Modem [Enabled]**  
This item allows users to power on the system by Modem. The choices are "Enabled" and "Disabled".
- **PowerOn by Alarm [Disabled]**  
The choices are "Enabled" and "Disabled". If enabled, the fields that follow indicate dates and times of alarm settings.





### 3.2.11 PC Health Status

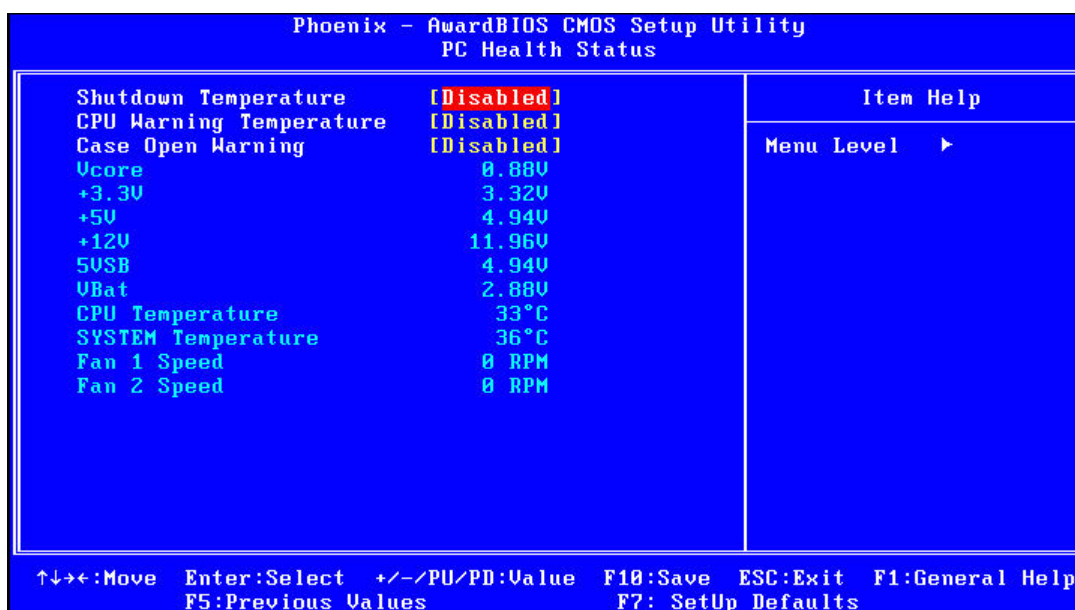

- **Shutdown Temperature [Disabled]**  
The system will shut down automatically if the CPU temperature goes over the selected setting.
- **CPU Warning Temperature [Disabled]**  
The system will give an automatic warning if the CPU temperature goes over the selected setting.
- **Case Open Warning [Disabled]**  
Enable this to detect if the case is open or closed.
- **VCORE and Other Voltages**  
This shows the voltage of VCORE, +3.3 V, +5 V, +12 V, 5VSB, VBat(V)
- **CPU Temperature**  
This shows the current CPU temperature.
- **SYSTEM Temperature**  
This shows the current temperature of the system.
- **FAN 1 Speed**  
This shows the current FAN 1 operating speed.
- **FAN 2 Speed**  
This shows the current FAN 2 operating speed.

### 3.2.12 Frequency/Voltage Control

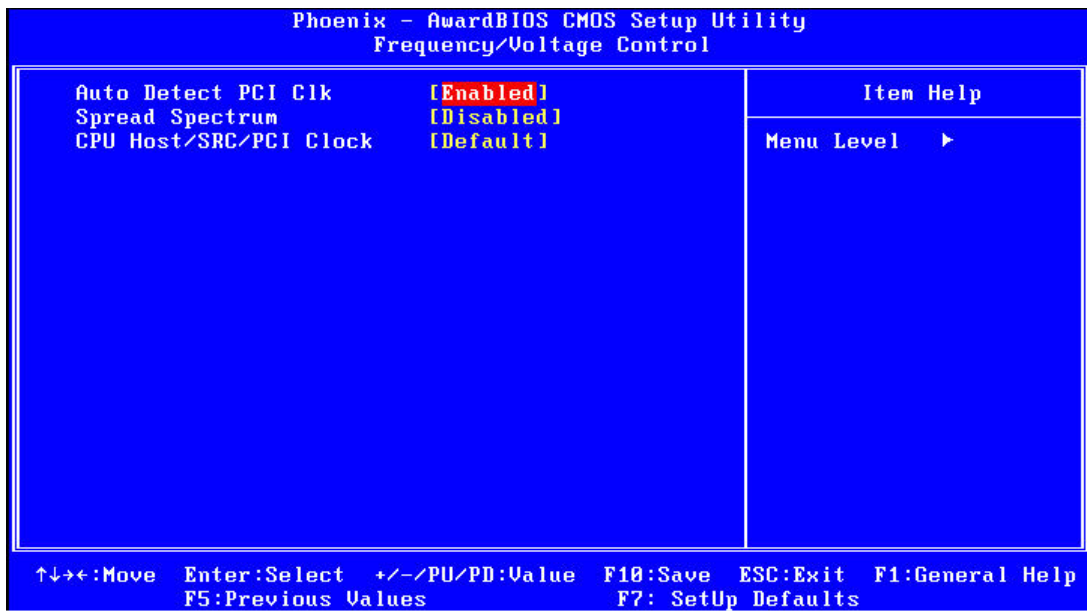

- **Auto Detect PCI Clk [Enabled]**  
This item enables users to set the PCI Clock by system automatic detection or by manual.
- **Spread Spectrum [Disabled]**  
This item enables users to set the spread spectrum modulation.
- **CPU Host/SRC/PCI Clock [Default]**  
This item enables users to set the CPU Host and PCI clock by system automatic detection or by manual.

### 3.2.13 Load Setup Defaults

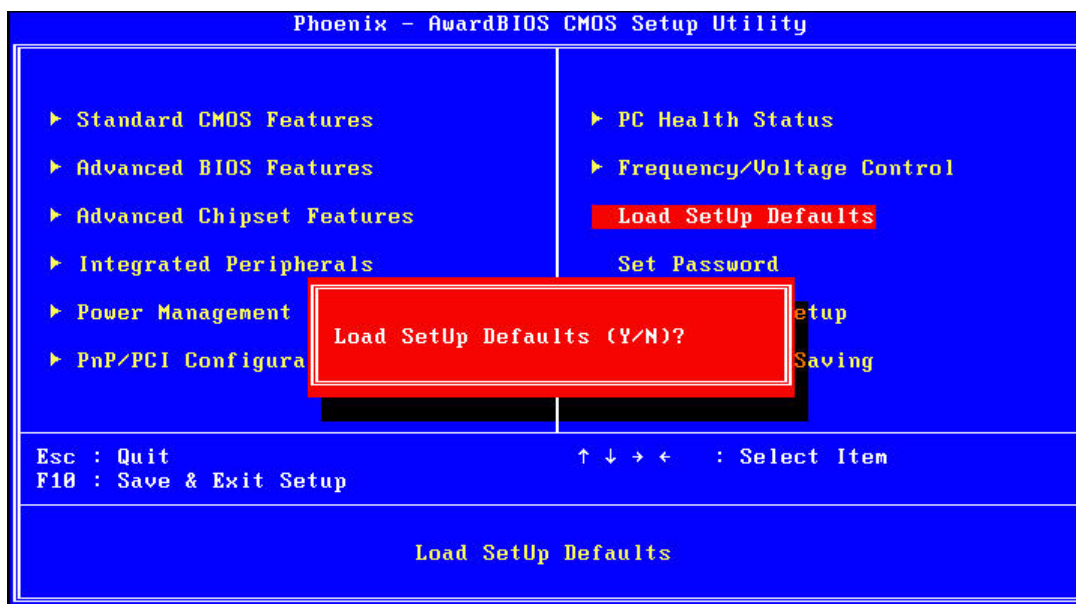

**Note!** *Load Setup Defaults loads the default system values directly from ROM. Useful if the stored record created by the Setup program should ever become corrupted (and therefore unusable).*



### 3.2.14 Set Password

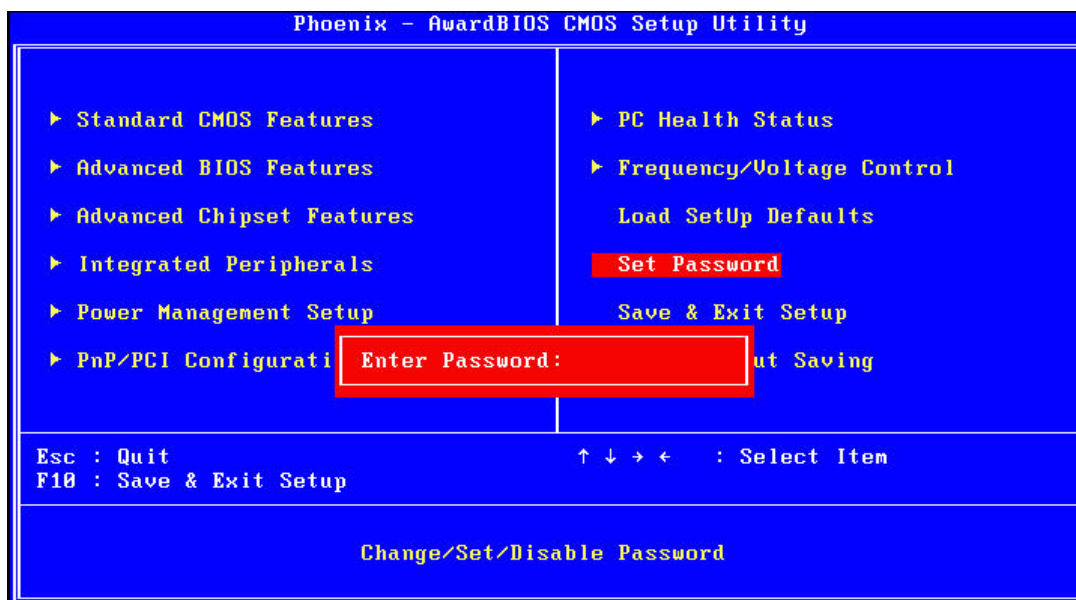

**Note!** *To enable this feature, you should first go to the Advanced BIOS Features menu, choose the Security Option, and select either Setup or System, depending on which aspect you want password protected. "Setup" requires a password only to enter Setup. "System" requires the password either to enter Setup or to boot the system. A password can be at most 8 characters long.*



---

#### To Establish Password

1. Choose the Set Password option from the CMOS Setup Utility main menu and press <Enter>.
2. When you see "Enter Password", enter the desired password and press <Enter>.
3. At the "Confirm Password" prompt, retype the desired password, then press <Enter>.
4. Select Save to CMOS and EXIT, type <Y>, then <Enter>.

#### To Change Password

1. Choose the Set Password option from the CMOS Setup Utility main menu and press <Enter>.
2. When you see "Enter Password", enter the existing password and press <Enter>.
3. You will see "Confirm Password". Type it again, and press <Enter>.
4. Select Set Password again, and at the "Enter Password" prompt, enter the new password and press <Enter>.
5. At the "Confirm Password" prompt, retype the new password, and press <Enter>.
6. Select Save to CMOS and EXIT, type <Y>, then <Enter>.

#### To Disable Password

1. Choose the Set Password option from the CMOS Setup Utility main menu and press <Enter>.
2. When you see "Enter Password", enter the existing password and press <Enter>.
3. You will see "Confirm Password". Type it again, and press <Enter>.
4. Select Set Password again, and at the "Enter Password" prompt, please don't enter anything; just press <Enter>.
5. At the "Confirm Password" prompt, again, don't type in anything; just press <Enter>.
6. Select Save to CMOS and EXIT, type <Y>, then <Enter>.

### 3.2.15 Save & Exit Setup

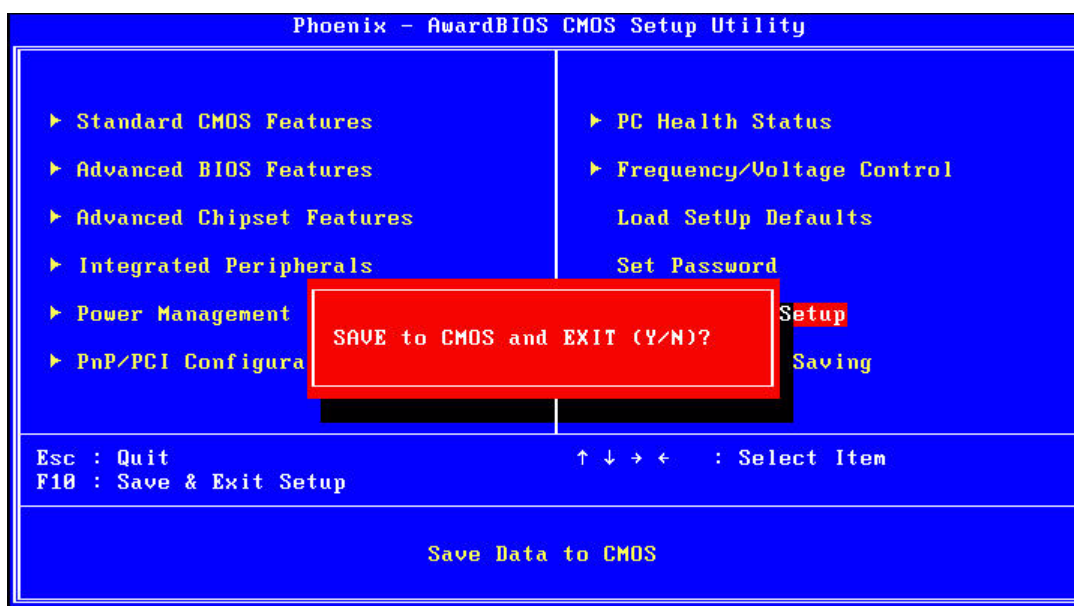

**Note!** Typing “Y” will quit the BIOS Setup Utility and save user setup values to CMOS.



Typing “N” will return to BIOS Setup Utility.

### 3.2.16 Quit without Saving

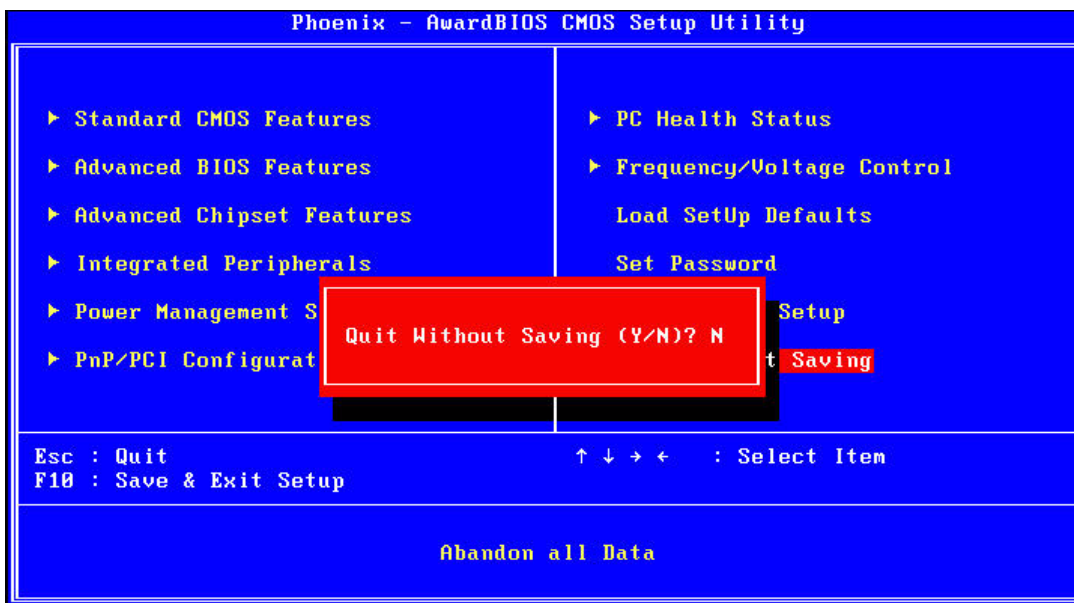

**Note!** Typing “Y” will quit the BIOS Setup Utility without saving to CMOS.



Typing “N” will return to BIOS Setup Utility.



# Chapter 4

## Software Installation

This chapter introduces driver installation.

## 4.1 Chipset Driver Installation

### 4.1.1 Before You Begin

To facilitate the installation of the enhanced display drivers and utility software, read the instructions in this chapter carefully. The drivers for ARK-3202 are located on the software installation CD. The driver in the folder of the driver CD will guide and link you to the utilities and drivers under a Windows system. Updates are provided via Service Packs from Microsoft\*.

**Note!** *The files on the software installation CD are compressed. Do not attempt to install the drivers by copying the files manually. You must use the supplied SETUP program to install the drivers.*



Before you begin, it is important to note that most display drivers need to have the relevant software application already installed in the system prior to installing the enhanced display drivers. In addition, many of the installation procedures assume that you are familiar with both the relevant software applications and operating system commands. Review the relevant operating system commands and the pertinent sections of your application software's user manual before performing the installation.

### 4.1.2 Introduction

The Intel® Chipset Software Installation (CSI) utility installs the Windows INF files that outline to the operating system how the chipset components will be configured. This is needed for the proper functioning of the following features:

- Core PCI PnP services
- IDE Ultra ATA 100/66/33 and Serial ATA interface support
- USB 1.1/2.0 support (USB 2.0 driver needs to be installed separately for Win98)
- Identification of Intel® chipset components in the Device Manager
- Integrates superior video features. These include filtered sealing of 720 pixel DVD content, and MPEG-2 motion compensation for software DVD

**Note!** *This utility is used for the following versions of Windows, and it has to be installed **before** installing all the other drivers:*



- Windows 2000
- Windows XP
- Windows Vista



### 4.1.3 Windows XP Driver Setup

1. Insert the driver CD into your system's CD-ROM drive. You can see the driver folder items. Navigate to the "Drv\_INF" folder and click "infnst\_autol.exe" to complete the installation of the driver.

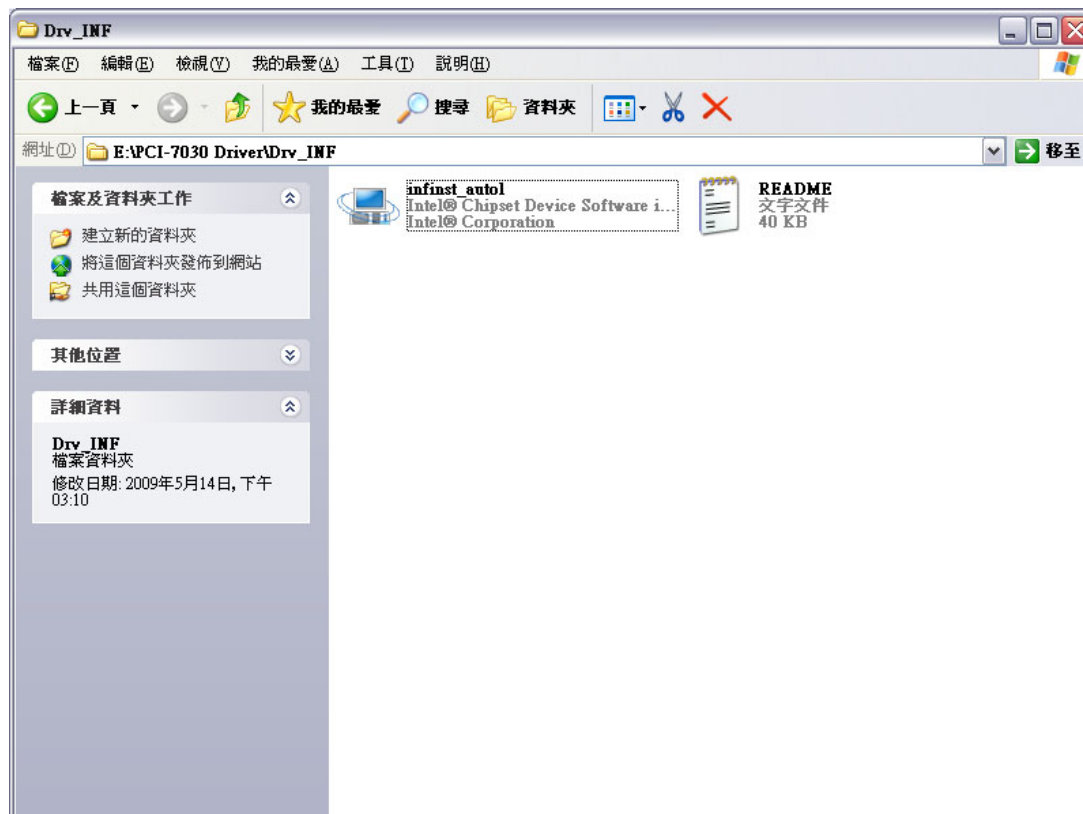
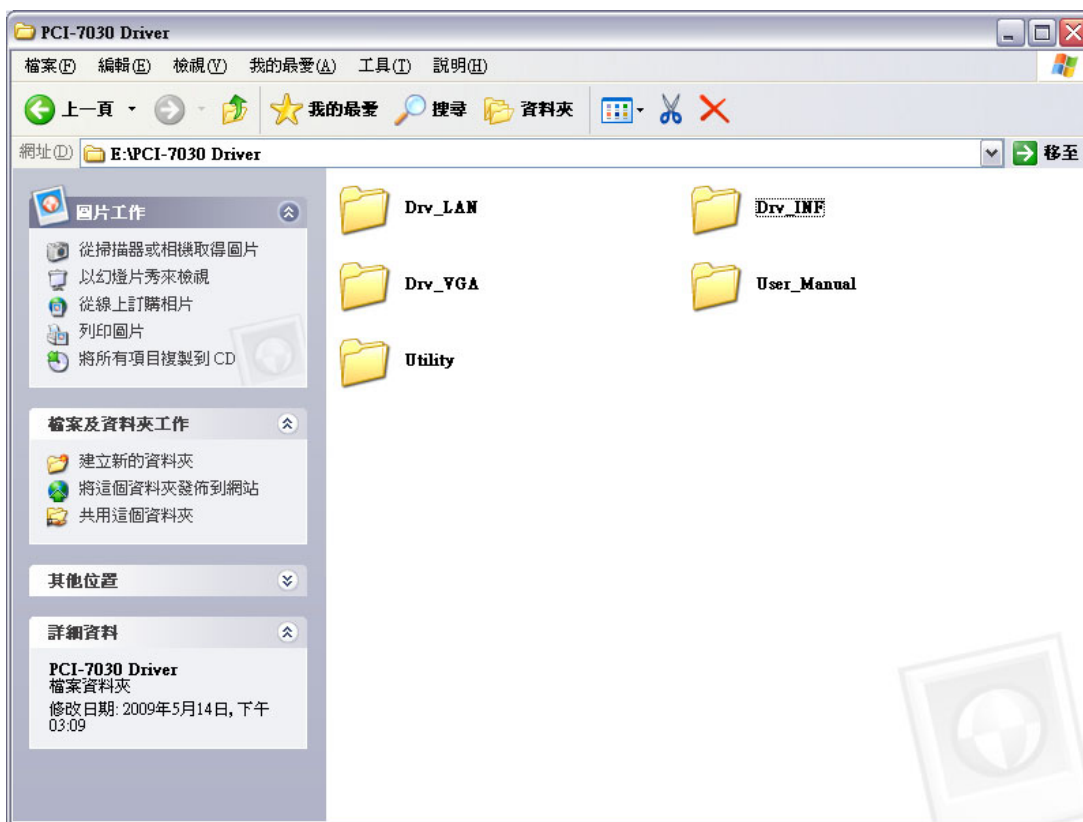

## 4.2 VGA Driver Installation

### 4.2.1 Introduction

To benefit from the Intel® 945GSE integrated graphics controller, you need to install the VGA driver. The Intel® 945GSE integrated graphics controller includes the following features:

- Intel® Graphics Media Accelerator 950: Incorporating the latest Microsoft® DirectX 9 support capabilities. Dual independent display, enhanced display modes for widescreen flat panels, and optimized 3D support deliver an intense and realistic visual experience without requiring a separate graphics card.

### 4.2.2 Windows Vista/XP/2000

**Note!** Before installing this driver, make sure the CSI utility has been installed in your system. See Chapter 4 for information on installing the CSI utility.



Insert the driver CD into your system's CD-ROM drive. You can see the driver folders items. Navigate to the "Drv\_VGA" folder and click "setup.exe" to complete the installation of the drivers for Vista, Windows XP, and Windows 2000.

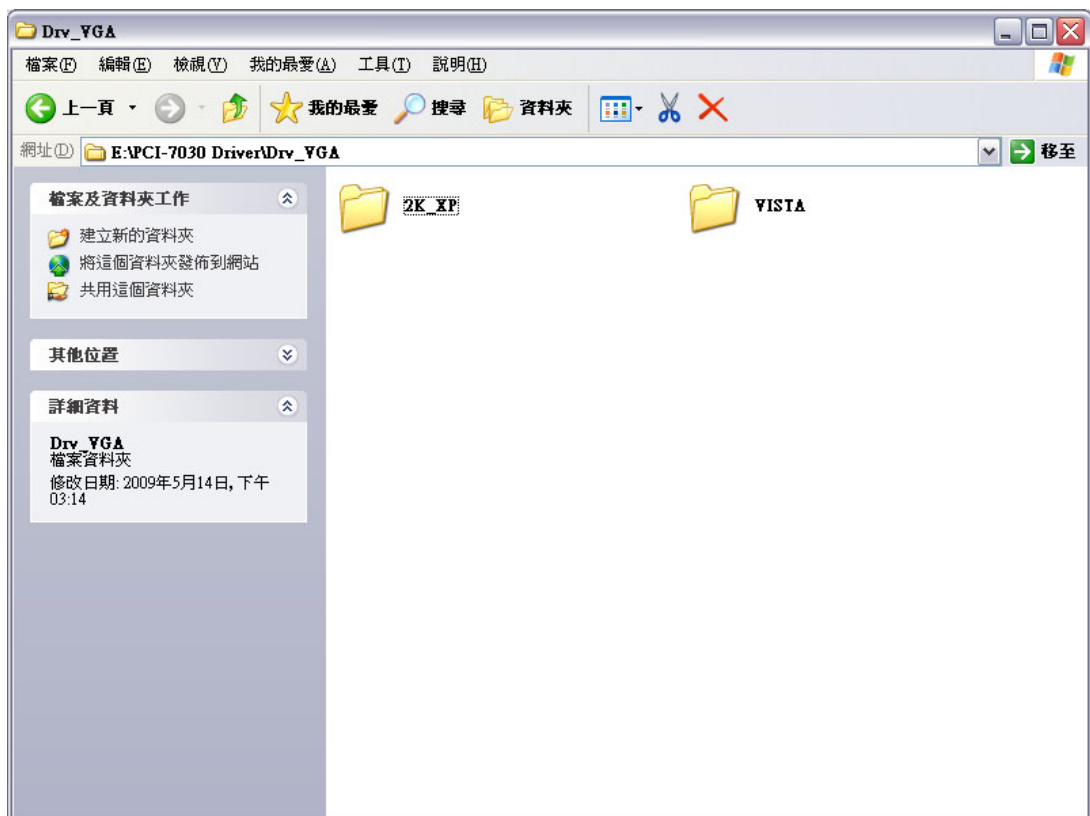

## 4.3 LAN Driver Installation

### 4.3.1 Introduction

The PCI-7030 has a dual Gigabit Ethernet LAN via dedicated PCI Express x 1 bus (Intel82574L), which offers bandwidth of up to 500 MB/sec, eliminating the bottleneck of network data flow and incorporating Gigabit Ethernet to operate at 1000Mbps. Features

### 4.3.2 Installation

**Note!** Before installing the LAN drivers, make sure the CSI utility has been installed on your system. See Chapter 4 for information on installing the CSI utility.



The PCI-7030 Intel82574L Gigabit integrated controller supports all major network operating systems. However, the installation procedure varies with different operating systems. Please find and use the section that provides the driver setup procedure for the operating system you are using.

### 4.3.3 Win XP/Vista Driver Setup

Insert the driver CD into your system's CD-ROM drive. Select the Drv\_LAN folder then navigate to the directory for your OS.

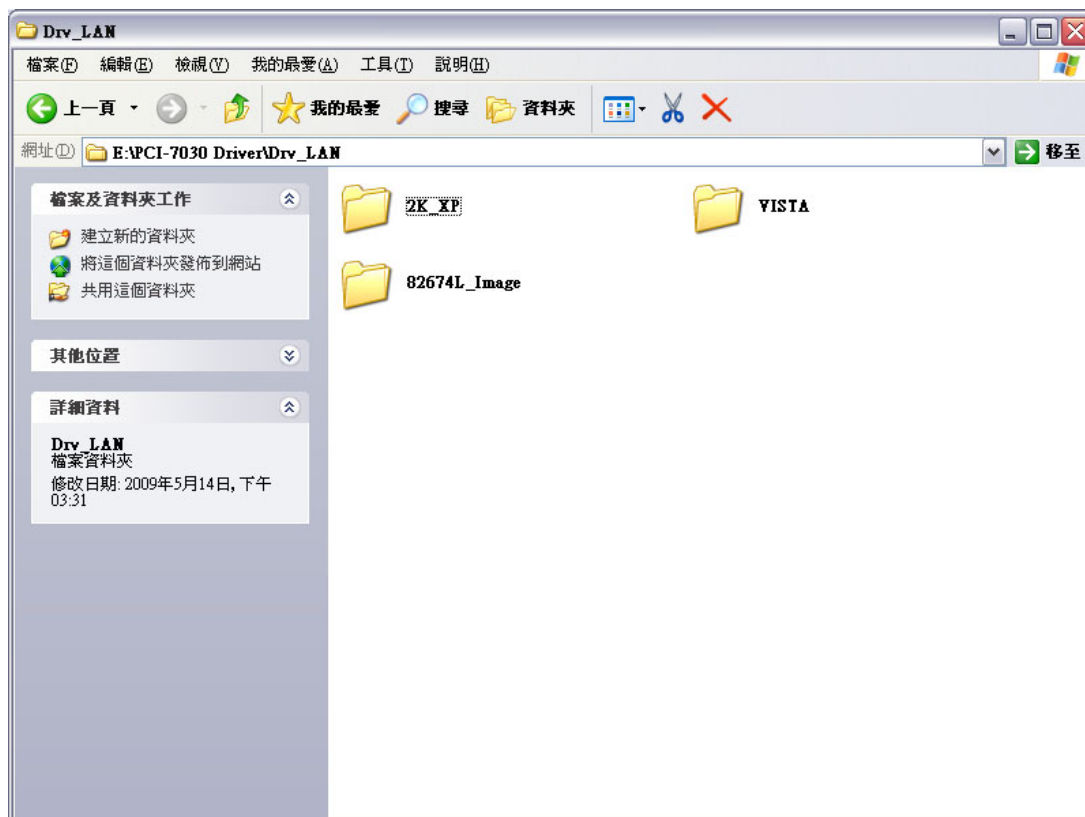

## 4.4 Audio Driver Installation

1. Change folder address to \Drivers\Audio. And double click to execute WDM\_R173.exe.

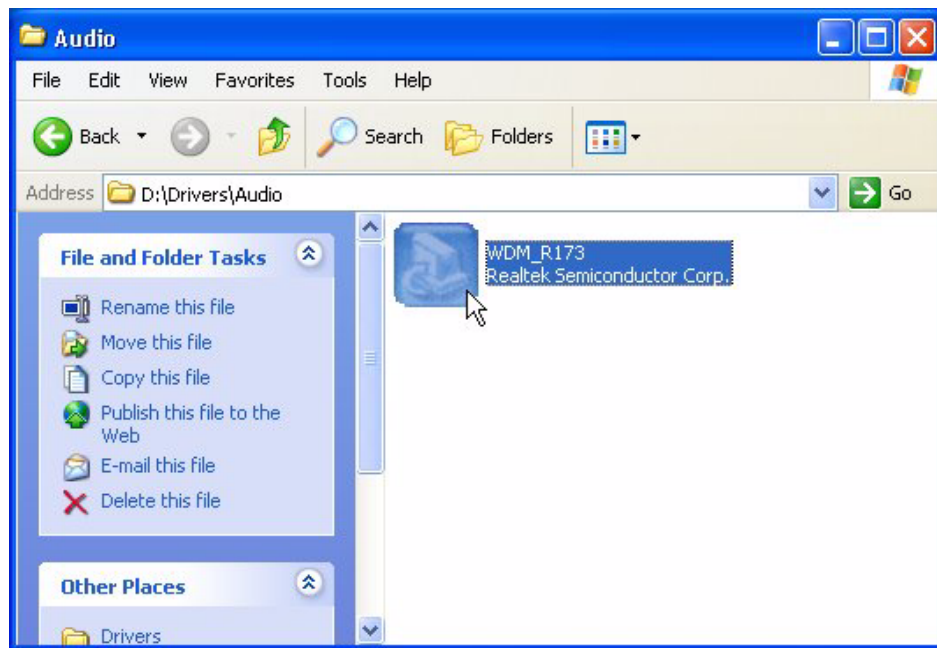

2. Click "Next" button to skip welcome message.

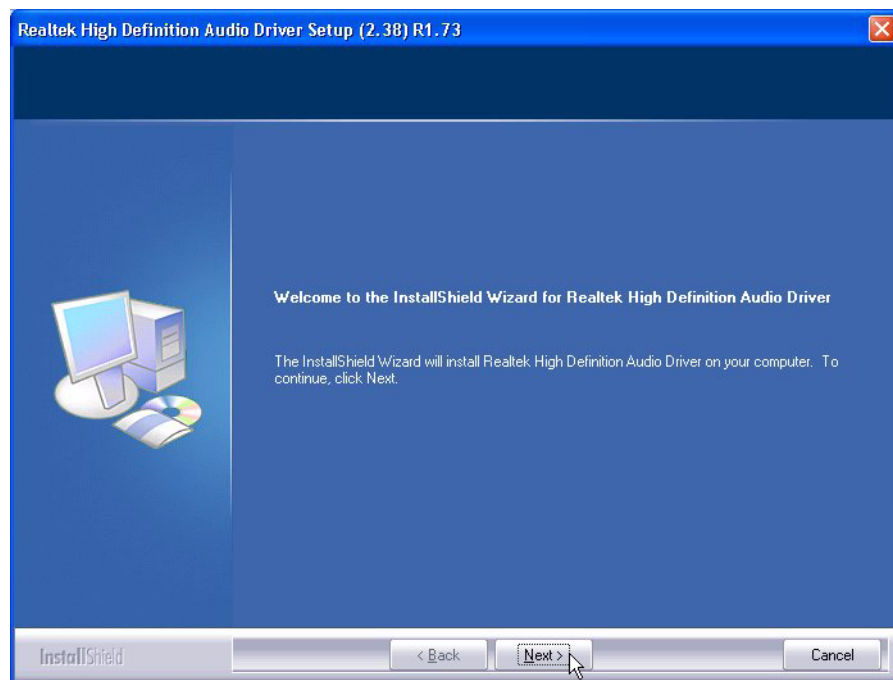

3. Select "Yes, I want to restart this computer now," and click "Finish" button. The computer will restart automatically. Then the driver installation is completed.

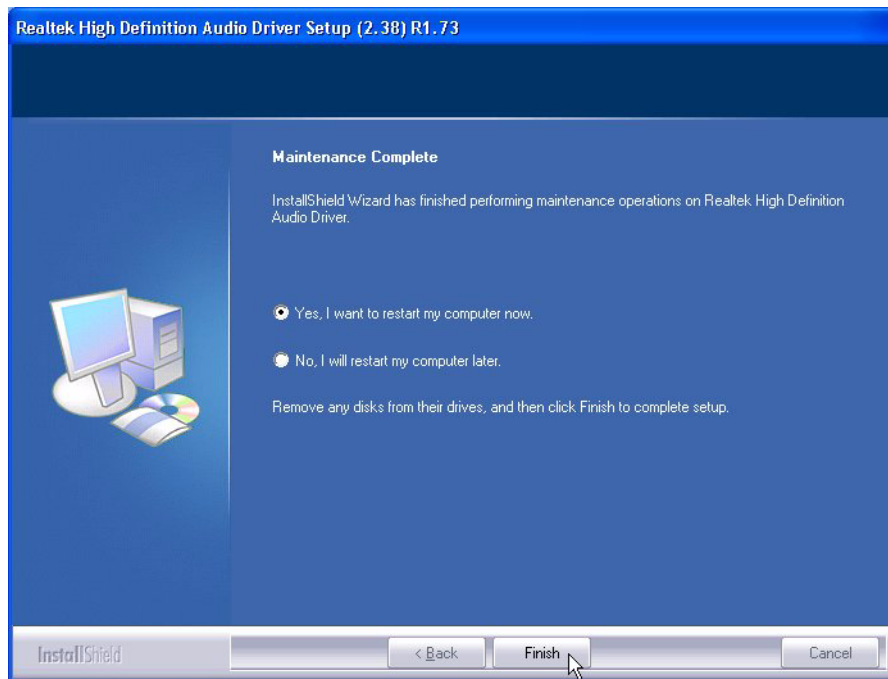

*Trusted ePlatform Services*

**ADVANTECH**

**[www.advantech.com](http://www.advantech.com)**

Please verify specifications before quoting. This guide is intended for reference purposes only.

All product specifications are subject to change without notice.

No part of this publication may be reproduced in any form or by any means, electronic, photocopying, recording or otherwise, without prior written permission of the publisher.

All brand and product names are trademarks or registered trademarks of their respective companies.

© Advantech Co., Ltd. 2009