



User Manual

ARK-1360

Box IPC

Trusted ePlatform Services

ADVANTECH

Attention!

This package contains a hard-copy user manual in Chinese for China CCC certification purposes, and there is an English user manual included as a PDF file on the CD. Please disregard the Chinese hard copy user manual if the product is not to be sold and/or installed in China.

Copyright

The documentation and the software included with this product are copyrighted 2009 by Advantech Co., Ltd. All rights are reserved. Advantech Co., Ltd. reserves the right to make improvements in the products described in this manual at any time without notice. No part of this manual may be reproduced, copied, translated or transmitted in any form or by any means without the prior written permission of Advantech Co., Ltd. Information provided in this manual is intended to be accurate and reliable. However, Advantech Co., Ltd. assumes no responsibility for its use, nor for any infringements of the rights of third parties, which may result from its use.

Acknowledgements

Award is a trademark of Award Software International, Inc.

VIA is a trademark of VIA Technologies, Inc.

IBM, PC/AT, PS/2 and VGA are trademarks of International Business Machines Corporation.

Intel® and Pentium® are trademarks of Intel Corporation.

Microsoft Windows® is a registered trademark of Microsoft Corp.

RTL is a trademark of Realtek Semi-Conductor Co., Ltd.

ESS is a trademark of ESS Technology, Inc.

UMC is a trademark of United Microelectronics Corporation.

SMI is a trademark of Silicon Motion, Inc.

Creative is a trademark of Creative Technology LTD.

CHRONTEL is a trademark of Chrontel Inc.

All other product names or trademarks are properties of their respective owners.

For more information about this and other Advantech products, please visit our website at:

<http://www.advantech.com/>

<http://www.advantech.com/ePlatform/>

For technical support and service, please visit our support website at:

<http://support.advantech.com.tw/support/>

Product Warranty (2 years)

Advantech warrants to you, the original purchaser, that each of its products will be free from defects in materials and workmanship for two years from the date of purchase.

This warranty does not apply to any products which have been repaired or altered by persons other than repair personnel authorized by Advantech, or which have been subject to misuse, abuse, accident or improper installation. Advantech assumes no liability under the terms of this warranty as a consequence of such events.

Because of Advantech's high quality-control standards and rigorous testing, most of our customers never need to use our repair service. If an Advantech product is defective, it will be repaired or replaced at no charge during the warranty period. For out-of-warranty repairs, you will be billed according to the cost of replacement materials, service time and freight. Please consult your dealer for more details.

If you think you have a defective product, follow these steps:

1. Collect all the information about the problem encountered. (For example, CPU speed, Advantech products used, other hardware and software used, etc.) Note anything abnormal and list any onscreen messages you get when the problem occurs.
2. Call your dealer and describe the problem. Please have your manual, product, and any helpful information readily available.
3. If your product is diagnosed as defective, obtain an RMA (return merchandise authorization) number from your dealer. This allows us to process your return more quickly.
4. Carefully pack the defective product, a fully-completed Repair and Replacement Order Card and a photocopy proof of purchase date (such as your sales receipt) in a shippable container. A product returned without proof of the purchase date is not eligible for warranty service.
5. Write the RMA number visibly on the outside of the package and ship it prepaid to your dealer.

Declaration of Conformity

FCC Class A

Note: This equipment has been tested and found to comply with the limits for a Class A digital device, pursuant to part 15 of the FCC Rules. These limits are designed to provide reasonable protection against harmful interference when the equipment is operated in a commercial environment. This equipment generates, uses, and can radiate radio frequency energy and, if not installed and used in accordance with the instruction manual, may cause harmful interference to radio communications. Operation of this equipment in a residential area is likely to cause harmful interference in which case the user will be required to correct the interference at his own expense.

Technical Support and Assistance

1. Visit the Advantech web site at www.advantech.com/support where you can find the latest information about the product.
2. Contact your distributor, sales representative, or Advantech's customer service center for technical support if you need additional assistance. Please have the following information ready before you call:
 - Product name and serial number
 - Description of your peripheral attachments
 - Description of your software (operating system, version, application software, etc.)
 - A complete description of the problem
 - The exact wording of any error messages

Warnings, Cautions and Notes

Warning! *Warnings indicate conditions, which if not observed, can cause personal injury!*



Caution! *Cautions are included to help you avoid damaging hardware or losing data.*



Note! *Notes provide optional additional information.*



Safety Instructions

1. Read these safety instructions carefully.
2. Keep this User Manual for later reference.
3. Disconnect this equipment from any AC outlet before cleaning. Use a damp cloth. Do not use liquid or spray detergents for cleaning.
4. For plug-in equipment, the power outlet socket must be located near the equipment and must be easily accessible.
5. Keep this equipment away from humidity.
6. Put this equipment on a reliable surface during installation. Dropping it or letting it fall may cause damage.
7. The openings on the enclosure are for air convection. Protect the equipment from overheating. **DO NOT COVER THE OPENINGS.**
8. Make sure the voltage of the power source is correct before connecting the equipment to the power outlet.
9. Position the power cord so that people cannot step on it. Do not place anything over the power cord.
10. All cautions and warnings on the equipment should be noted.
11. If the equipment is not used for a long time, disconnect it from the power source to avoid damage by transient overvoltage.
12. Never pour any liquid into an opening. This may cause fire or electrical shock.
13. Never open the equipment. For safety reasons, the equipment should be opened only by qualified service personnel.
14. If one of the following situations arises, get the equipment checked by service personnel:
 - The power cord or plug is damaged.
 - Liquid has penetrated into the equipment.
 - The equipment has been exposed to moisture.
 - The equipment does not work well, or you cannot get it to work according to the user's manual.
 - The equipment has been dropped and damaged.
 - The equipment has obvious signs of breakage.
15. **DO NOT LEAVE THIS EQUIPMENT IN AN ENVIRONMENT WHERE THE STORAGE TEMPERATURE MAY GO BELOW -20° C (-4° F) OR ABOVE 60° C (140° F). THIS COULD DAMAGE THE EQUIPMENT. THE EQUIPMENT SHOULD BE IN A CONTROLLED ENVIRONMENT.**
16. **CAUTION: DANGER OF EXPLOSION IF BATTERY IS INCORRECTLY REPLACED. REPLACE ONLY WITH THE SAME OR EQUIVALENT TYPE RECOMMENDED BY THE MANUFACTURER, DISCARD USED BATTERIES ACCORDING TO THE MANUFACTURER'S INSTRUCTIONS.**

The sound pressure level at the operator's position according to IEC 704-1:1982 is no more than 70 dB (A).

DISCLAIMER: This set of instructions is given according to IEC 704-1. Advantech disclaims all responsibility for the accuracy of any statements contained herein.

Packing list

Before installation, please ensure the following items have been shipped:

- 1 x ARK-1360 Unit
- 1 x Driver CD (Drivers and Manual)
- 1 x China RoHS
- 1 X Traditional Chinese User Manual for CCC

Ordering information

Model Number	Description
ARK-1360F-S1A1E	Intel Atom Z510 1.1GHz w/ mini-PCIe+8*DIO+2*COM
ARK-1360F-S6A1E	Intel Atom Z530 1.6GHz w/ mini-PCIe+8*DIO+2*COM

Optional accessories

Part Number	Description
1757002942	AC-to-DC Adapter AC 90-264V 36W/12V Power Plug, 0 ~ 40°C for Home and Office Use
1700001524	Power Cable 3-pin 180 cm, USA Type
170203183C	Power Cable 3-pin 180 cm, Europe Type
170203180A	Power Cable 3-pin 180 cm, UK Type
1700008921	Power Cable 3-pin 180 cm, PSE Mark
1700060202	PS2 Keyboard/Mouse Cable
1700012536	Phenix 10P DIO cable for ARK-1360/ARK-1388
9666K10000E	DIN-Rail mounting kit for ARK-1000 series models
9666K10001E	VESA mounting kit for ARK-1000 series models
968EMW0021	Wireless IEEE 802.11b/g/n, miniPCIe interface WLAN
1700001854	SMA cable 11CM for 968EMW0021 WLAN module
1750003222	802.11b/g 5dBi Dipole Antenna for 968EMW0021 WLAN module
968EMC0010	7.2 Mbps HSDPA PCI Express Mini Card
1700006712	SMA F to MHF 1.32 cable for 968EMC0010 HSDPA module
1750004421	GPRS Antenna 5 Band for 968EMC0010 HSDPA module

Contents

Chapter 1	General Introduction	1
1.1	Introduction	2
1.2	Product Feature	2
1.2.1	General	2
1.2.2	Display	2
1.2.3	Power consumption	2
1.3	Hardware Specification	3
1.4	Mechanical Specification.....	3
1.4.1	Dimensions	3
	Figure 1.1 ARK-1360 Mechanical dimension drawing.....	3
1.4.2	Weight.....	4
1.5	Power requirement.....	4
1.5.1	System power	4
1.5.2	RTC battery.....	4
1.6	Environment specification	4
1.6.1	Operating temperature.....	4
1.6.2	Relative Humidity	4
1.6.3	Storage Temperature.....	4
1.6.4	Vibration loading during operation	4
1.6.5	Shock during operation	4
1.6.6	Safety.....	4
1.6.7	EMC	4
Chapter 2	Hardware installation	7
2.1	ARK-1360 I/O Indication	8
	Figure 2.1 ARK-1360 Front View.....	8
	Figure 2.2 ARK-1360 Rear View	8
2.2	ARK-1360 front side external I/O connectors.....	8
2.2.1	Power ON/OFF Button.....	8
	Figure 2.3 Power ON/OFF Button	8
2.2.2	Power Input Connector	9
	Figure 2.4 Power Input Connector.....	9
2.2.3	Ethernet Connector (LAN)	9
	Figure 2.5 Ethernet Connector	9
	Table 2.1: Ethernet Connector Pin Assignments.....	9
2.2.4	VGA Connector.....	10
	Figure 2.6 VGA Connector	10
	Table 2.2: VGA Connector Pin Assignments.....	10
2.2.5	PS2 Keyboard/Mouse Connector	10
	Figure 2.7 PS/2 Connector	10
	Table 2.3: PS/2 Keyboard/Mouse Connector Pin Assignments	10
2.2.6	USB Connectors	11
	Figure 2.8 USB Connector.....	11
	Table 2.4: USB Connector Pin Assignments.....	11
2.2.7	Audio Connector	11
	Figure 2.9 MIC and Line-out Connector	11
2.3	ARK-1360 rear side external I/O connectors	12
2.3.1	COM Connector.....	12
	Figure 2.10COM Port Connector.....	12
	Table 2.5: COM Connector Pin Assignments	12
2.3.2	DIO Connector.....	12
	Figure 2.11DIO Connector.....	12
	Table 2.6: DIO Connector Pin Assignments.....	12

	Figure 2.12 DIO Cable.....	13
	Table 2.7: DIO Cable Pin Assignments.....	13
2.4	Compact Flash and Memory Installation.....	14
	Figure 2.13 CF Card and Memory Installation.....	14

Chapter 3 BIOS settings 15

3.1	BIOS Introduction.....	16
3.2	BIOS Setup.....	16
3.2.1	Main Menu.....	17
3.2.2	Standard CMOS Features.....	18
3.2.3	Advanced BIOS Features.....	19
3.2.4	Advanced Chipset Features.....	22
3.2.5	Integrated Peripherals.....	23
3.2.6	PnP/PCI Configurations.....	27
3.2.7	PC Health Status.....	28
3.2.8	Setup Defaults.....	29
3.2.9	Set Supervisor Password.....	30
3.2.10	Set User Password.....	31
3.2.11	Save and Exit Setup.....	32
3.2.12	Exit Without Saving.....	32

Appendix A Adding miniPCle Card Procedure ... 33

A.1	Full disassembly procedure.....	34
A.2	Full assembly procedure.....	38

Chapter 1

General Introduction

This chapter gives background information on ARK-1360 series.

1.1 Introduction

ARK-1360 Embedded Box IPC is an application ready system platform solution. All electronics are protected in a compact sealed aluminum case for easy integration in the customers own housing, or as a stand-alone application, where space is limited and the environment harsh.

ARK-1360 answers this demand by offering 4 x USB 2.0 ports, 1 x GbE LAN port , 2 x COM ports and 1 x 8-bit GPIO port; packed into a small rugged unit and powered by an Intel Atom Z510P 1.1GHz/Z530P 1.6GHz processor. ARK-1360 is also with 1 x miniPCIe interface for expansion. The ARK-1360 Compact Embedded Computer can be equipped with a solid state onboard CF card of up to 32 GB, so it easily passes 50 and 5 Grms shock and vibration tests. And it supports a wide range of input voltages from 12 VDC to 24 VDC.

ARK-1000 can be standalone, wall-mounted, DIN-rail mounted or VESA mounted. The series accepts a wide range of power supplies (DC power in) and comes in a footprint of only 189 x 41 x 130.6 mm (7.44" x 1.61" x 5.14"). The rugged cast aluminum case not only provides great protection from EMI, shock/vibration, cold and heat, but also passive cooling for quiet fanless operation.

1.2 Product Feature

1.2.1 General

- Intel® Atom® processor, support up to 1.6 GHz
- Mini-PCIe expansion for HSDPA/UMTS/EDGE/WLAN
- Supports VGA (LVDS optional)
- Supports 2 x RS-232 and 4 x USB 2.0
- Supports 1 x 10/100/1000 LAN
- Cost effective Atom solution

1.2.2 Display

- **Chipset:** Intel® System Controller Hub US15WP
- **Display Memory:** Intel® Graphics Media Accelerator 500 (Intel® GMA 500)
- **Resolution:** CRT Display mode: pixel resolution up to 1280 x 1024 at 85-Hz and 1366 x 768 at 85-Hz LVDS Display mode

1.2.3 Power consumption

- **Typical:** 8 W
- **Max.:** 11 W

1.3 Hardware Specification

- **CPU:** Intel® Atom® processor Z510P 1.1GHz/Z530P 1.6GHz
- **System Chipset:** Intel® System Controller Hub US15WP
- **BIOS:** AWARD 8-Mbit Flash BIOS
- **System Memory:** 1 x 200-pin SODIMM 2 GB DDR2 400/533 org.x16 SDRAM
- **SSD:** Supports Compact Flash Card TYPE I/II
- **Watchdog Timer:** Reset: 1 sec.~255 min. and 1 sec. or 1 min./step
- **I/O Interface:** 2 x RS232, 1 x PS/2
- **USB:** 4 x USB 2.0 compliant ports
- **Ethernet Chipset:** 1 x Realtek RTL 8111C Gigabit LAN
 - **Speed:** 10/100/1000 Mbps
 - **Interface:** 1 x RJ45 w/ LED
 - **Standard:** IEEE 802.3/802.3u compliant

Note! 1. System will not power on and beep without installing memory.



2. ARK-1360 doesn't support wake on LAN for S4&S5 mode.

1.4 Mechanical Specification

1.4.1 Dimensions

- 189 x 41 x 130.6 mm (7.44" x 1.61" x 5.14")

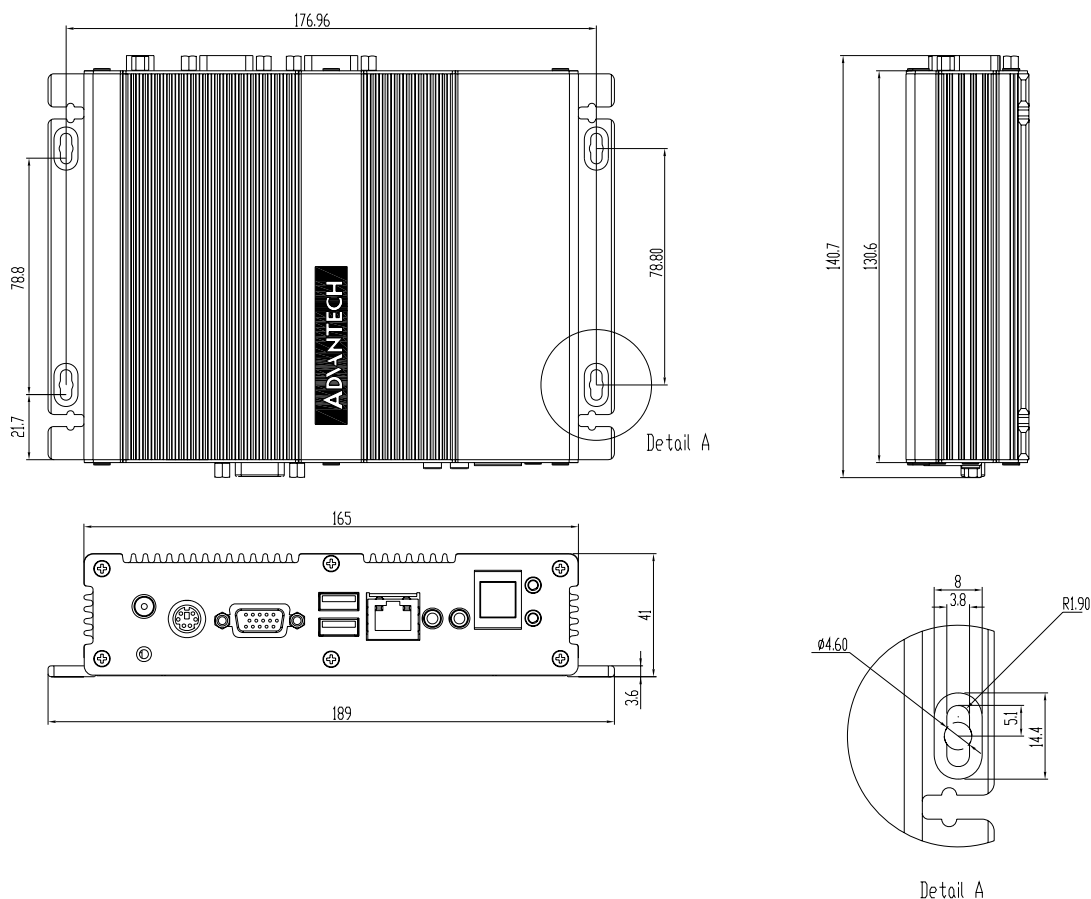

Figure 1.1 ARK-1360 Mechanical dimension drawing

1.4.2 Weight

- 1.05 kg (2.31lb)

1.5 Power requirement

1.5.1 System power

- Minimum power input: DC 12V-24V 1.9A-0.95A

1.5.2 RTC battery

- 3V/210 mAh

1.6 Environment specification

1.6.1 Operating temperature

- 0 ~ 55°C (32 ~ 131°F), with air flow, speed=0.7 m/sec

1.6.2 Relative Humidity

- 95% @ 40°C (non-condensing)

1.6.3 Storage Temperature

- -40 ~ 85°C (-40 ~ 185°F)

1.6.4 Vibration loading during operation

- 5 Grms, IEC 60068-2-64, random, 5 ~ 500 Hz, 1 Oct./min, 1 hr/axis.

1.6.5 Shock during operation

- 50 G, IEC 60068-2-27, half sine, 11 ms duration

1.6.6 Safety

- UL, CCC

1.6.7 EMC

- CE, FCC, CCC

Chapter 2

Hardware installation

This chapter introduces external IO and the installation of ARK-1360 Hardware.

2.1 ARK-1360 I/O Indication

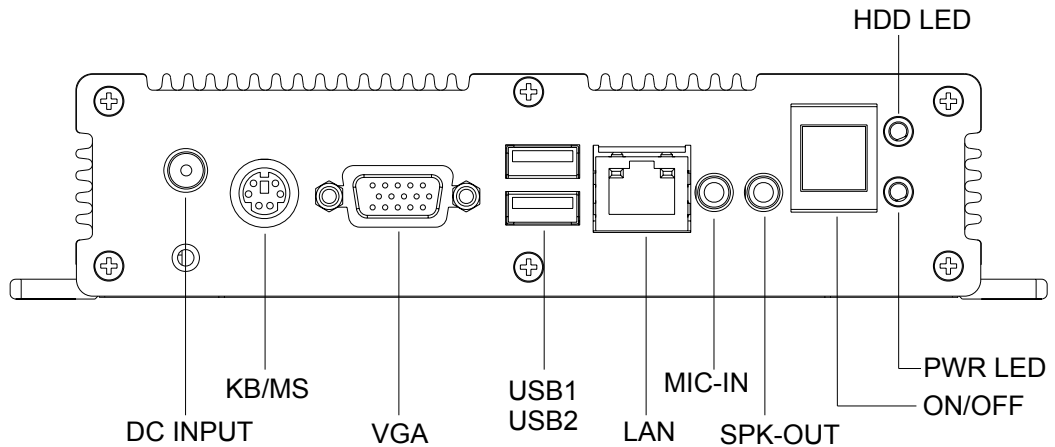

Figure 2.1 ARK-1360 Front View

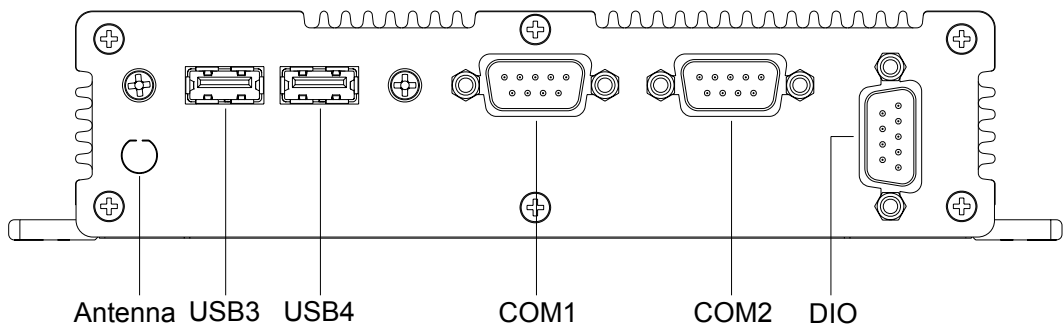

Figure 2.2 ARK-1360 Rear View

2.2 ARK-1360 front side external I/O connectors

2.2.1 Power ON/OFF Button

ARK-1360 has a power ON/OFF button on the front side. It only supports 4 second delay soft power off.

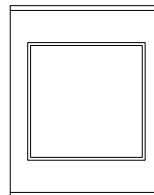

Figure 2.3 Power ON/OFF Button

Note! ARK-1360 doesn't support hardware power off.



2.2.2 Power Input Connector

ARK-1360 comes with a DC-Jack header that carries 12~24 VDC external power input.

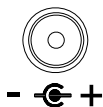

Figure 2.4 Power Input Connector

2.2.3 Ethernet Connector (LAN)

ARK-1360 provides two RJ45 LAN interface connectors, they are fully compliant with IEEE 802.3u 10/100/1000 Base-T CSMA/CD standards. The Ethernet ports use standard RJ-45 jack connectors with LED indicators on the front side to show Active/Link status and Speed status.

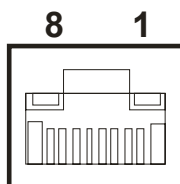

Figure 2.5 Ethernet Connector

Table 2.1: Ethernet Connector Pin Assignments

Pin	10/100 BaseT Signal Name
1	TX+
2	TX-
3	RX+
4	MDI2+
5	MDI2-
6	RX-
7	MDI3+
8	MDI3-

2.2.4 VGA Connector

The ARK-1360 provides a high resolution VGA interface connected by a D-sub 15-pin connector to support a VGA CRT monitor. It supports display resolution of up to 1280 x 1024 @ 85-Hz.

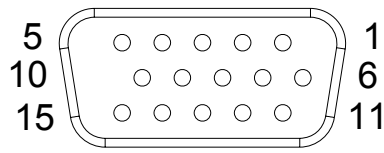

Figure 2.6 VGA Connector

Table 2.2: VGA Connector Pin Assignments

Pin	Signal Name	Pin	Signal Name
1	Red	2	Green
3	Blue	4	NC
5	GND	6	GND
7	GND	8	GND
9	NC	10	GND
11	NC	12	NC
13	H-SYNC	14	V-SYNC
15	NC		

2.2.5 PS2 Keyboard/Mouse Connector

The ARK-1360 provides a PS/2 keyboard/mouse connector. A 6-pin mini-DIN connector is located on the rear metal face plate of the ARK-1360. ARK-1360 comes with an adapter to convert from the 6-pin mini-DIN connector to two 6-pin mini-DIN connectors for PS/2 keyboards and PS/2 mouse connections.

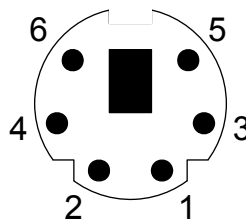

Figure 2.7 PS/2 Connector

Table 2.3: PS/2 Keyboard/Mouse Connector Pin Assignments

Pin	Signal Name
1	PS2_KBDAT
2	PS2_MS DAT
3	GND
4	VCC
5	PS2_KBCLK
6	PS2_MSCLK

2.2.6 USB Connectors

The ARK-1360 provides four USB interface connectors, which give complete Plug & Play and hot swapping for up to 127 external devices. The USB interface is compliant with USB UHCI, Rev. 2.0. The USB interface supports Plug and Play, which enables you to connect or disconnect a device whenever you want, without turning off the computer.

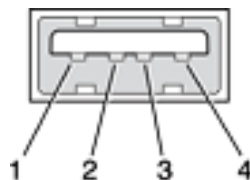

Figure 2.8 USB Connector

Table 2.4: USB Connector Pin Assignments

Pin	Signal Name	Pin	Signal Name
1	VCC	2	USB_data-
3	USB_data+	4	GND

2.2.7 Audio Connector

ARK-1360 offers stereo audio ports by two phone jack connectors of Line_Out and MIC. The audio chip controller is by ALC888 which is compliant with the Azalea standard.

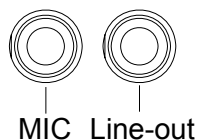

Figure 2.9 MIC and Line-out Connector

2.3 ARK-1360 rear side external I/O connectors

2.3.1 COM Connector

ARK-1360 provides two D-sub 9-pin connectors that are serial communication interface ports. Both of these two ports can support RS-232 mode communication.

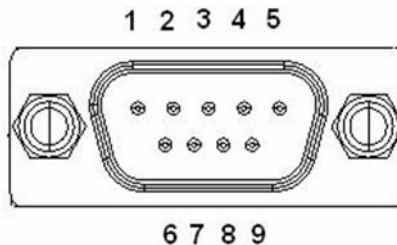

Figure 2.10 COM Port Connector

Table 2.5: COM Connector Pin Assignments

RS-232	
Pin	Signal Name
1	DCD
2	RXD
3	TXD
4	DTR
5	GND
6	DSR
7	RTS
8	CTS
9	RI

2.3.2 DIO Connector

ARK-1360 offers an 8-bit DIO connector and one ground pin. Each bit of DIO can be set as digital input or output independently. The direction of each bit can be set by Advantech SUSI utility in Windows XP environment.

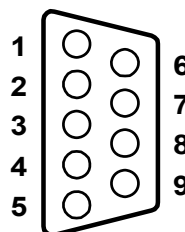

Figure 2.11 DIO Connector

Table 2.6: DIO Connector Pin Assignments

Pin	Signal Name
1	DIO bit0
2	DIO bit1

Table 2.6: DIO Connector Pin Assignments

3	DIO bit2
4	DIO bit3
5	DIO bit4
6	DIO bit5
7	DIO bit6
8	DIO bit7
9	GND

To connect with your devices, please use cable P/N: 1700012536 which is D-sub to 10-pin phoenix connector.

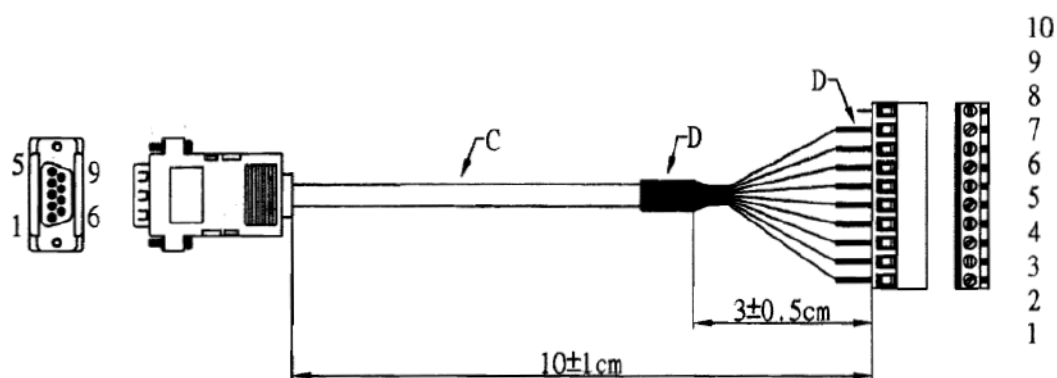
**Figure 2.12 DIO Cable****Table 2.7: DIO Cable Pin Assignments**

Phenix Connector Pin	Cable color	Signal Name
1	Black	DIO bit0
2	Brown	DIO bit5
3	Red	DIO bit1
4	Orange	DIO bit6
5	Yellow	DIO bit2
6	Green	DIO bit7
7	Blue	DIO bit3
8	Purple	GND
9	Grey	DIO bit4

2.4 Compact Flash and Memory Installation

1. Unscrew the bracket on the bottom side of ARK-1360.
2. Insert the CF card into the CF socket on the board firstly and then insert Memory into DDR2 SO-DIMM socket.

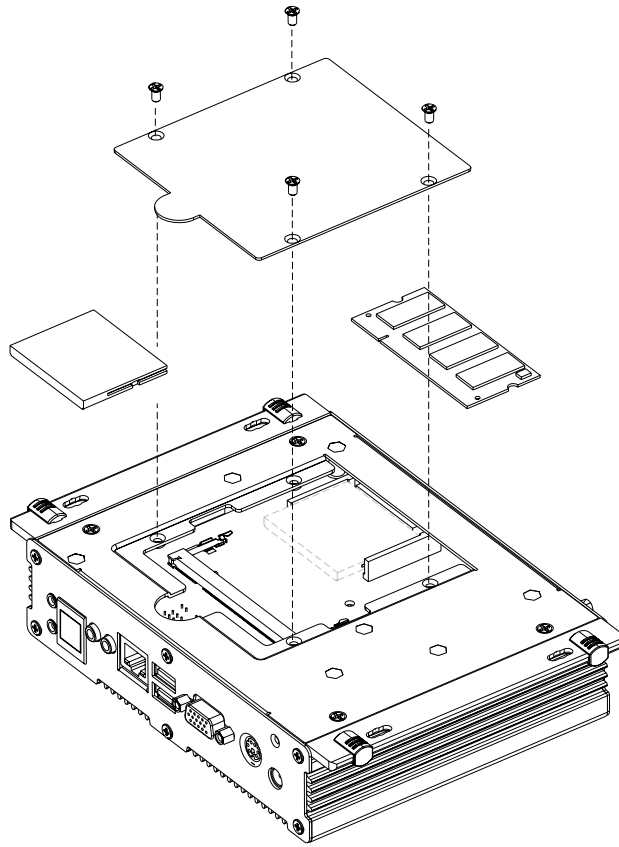

Figure 2.13 CF Card and Memory Installation

Chapter 3

BIOS settings

This chapter introduces how to set BIOS configuration data.

3.1 BIOS Introduction

AwardBIOS 6.0 is a full-featured BIOS provided by Advantech to deliver superior performance, compatibility, and functionality to industrial PCs and embedded boards. Its many options and extensions let you customize your products to a wide range of designs and target markets.

The modular, adaptable AwardBIOS 6.0 supports the broadest range of third-party peripherals and all popular chipsets, plus Intel, AMD, nVidia, VIA, and compatible CPUs from 386 through Pentium, AMD Geode, K7 and K8 (including multiple processor platforms), and VIA Eden C3 and C7 CPUs.

You can use Advantech's utilities to select and install features that suit your needs and your customers' needs.

3.2 BIOS Setup

The ARK-1360 Series system has build-in AwardBIOS with a CMOS SETUP utility which allows users to configure required settings or to activate certain system features.

The CMOS SETUP saves the configuration in the CMOS RAM of the motherboard. When the power is turned off, the battery on the board supplies the necessary power to the CMOS RAM so the settings are saved.

When the power is turned on, press the button during the BIOS POST (Power-On Self Test) which will take you to the CMOS SETUP screen.

CONTROL KEYS

< ↑ >> ↓ >> ← >> → >	Move to select item
<Enter>	Select Item
<Esc>	Main Menu - Quit and not save changes into CMOS Sub Menu - Exit current page and return to Main Menu
<Page Up/+>	Increase the numeric value or make changes
<Page Down/->	Decrease the numeric value or make changes
<F1>	General help, for Setup Sub Menu
<F2>	Item Help
<F5>	Load Previous Values
<F6>	Save all CMOS changes to BIOS
<F7>	Load Optimized Default
<F9>	Menu in BIOS
<F10>	Save all CMOS changes

3.2.1 Main Menu

Press to enter AwardBIOS CMOS Setup Utility, the Main Menu will appear on the screen. Use arrow keys to select among the items and press <Enter> to accept or enter the sub-menu.

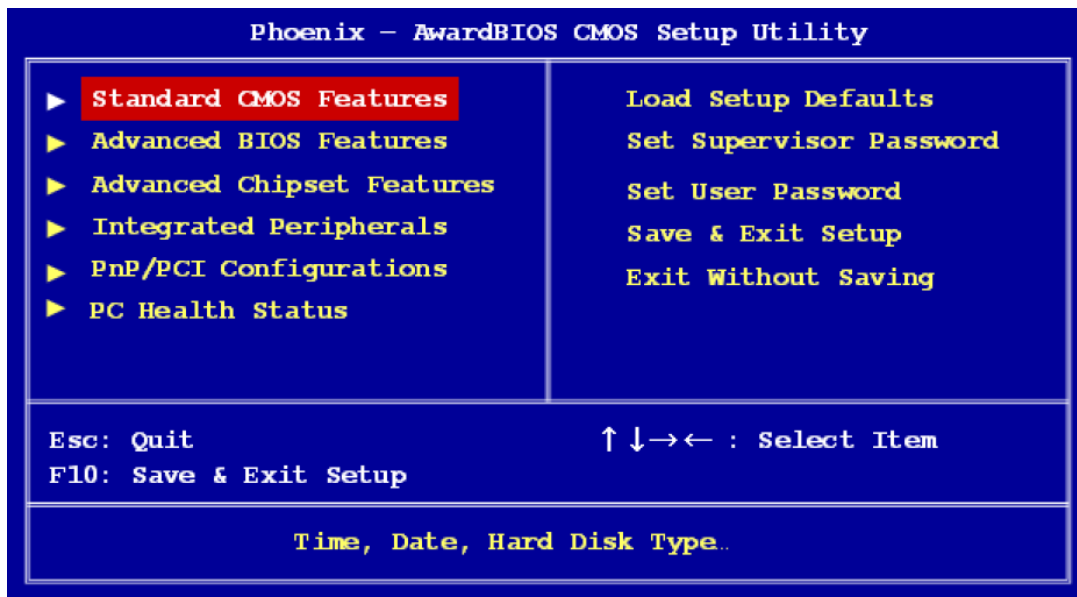

- **Standard CMOS Features**
This setup page includes all the features for standard CMOS configuration.
- **Advanced BIOS Features**
This setup page includes all the features for advanced BIOS configuration.
- **Advanced Chipset Features**
This setup page includes all the features for advanced chipset configuration.
- **Integrated Peripherals**
This setup page includes all onboard peripheral devices.
- **PnP/PCI Configurations**
This setup page includes PnP OS and PCI device configuration.
- **PC Health Status**
This entry displays the current system temperature, and Voltage.
- **Load Setup Defaults**
This selection loads optimized values for best system performance configuration.
- **Set Supervisor Password**
Establish, change or disable supervisor password
- **Set User Password**
Establish, change or disable user password.
- **Save & Exit Setup**
Save CMOS value settings to CMOS and exit BIOS setup.
- **Exit Without Saving**
Abandon all CMOS value changes and exit BIOS setup.

3.2.2 Standard CMOS Features

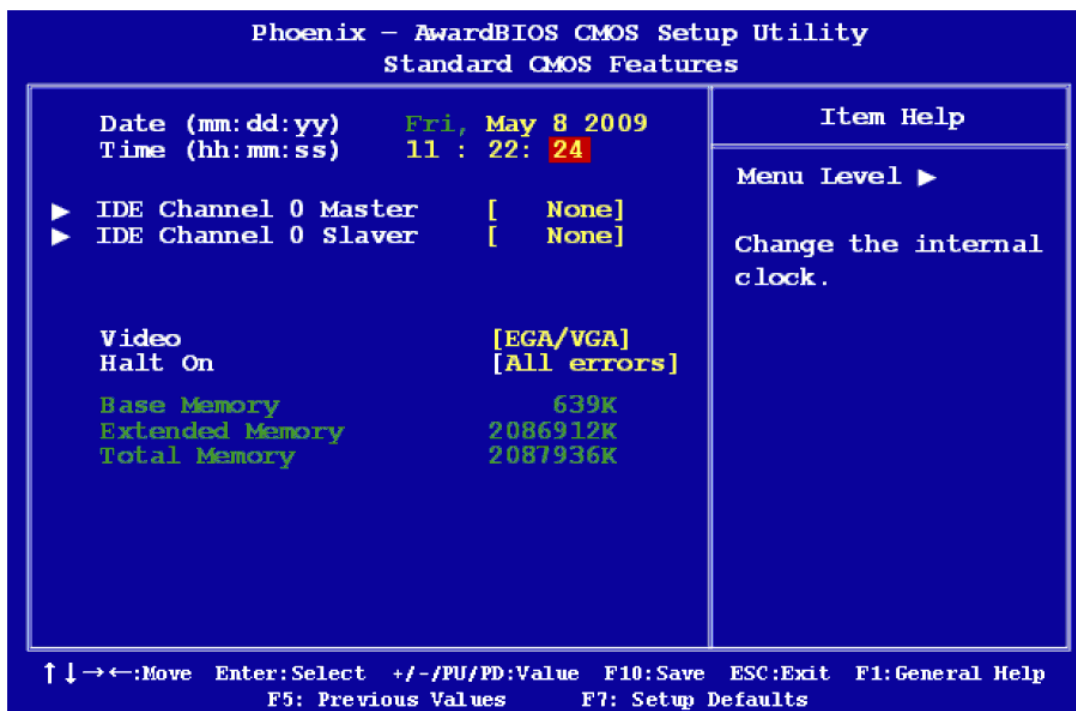

■ Date

The date format is <week>, <month>, <day>, <year>.

Weekday	From Sun to Sat, determined and display by BIOS only
Month	From Jan to Dec.
Day	From 1 to 31
Year	From 1999 through 2098

■ Time

The times format in <hour> <minute> <second>, based on the 24-hour time.

■ IDE Channel 0 Master/Slave

[None]:	Select this when no IDE device is used. The system will skip the auto-detection setup to make system start up faster.
[Auto]:	Automatically detects IDE devices during POST
[Manual]:	User can manually input the correct settings.

■ Video [EGA / VGA]

This category detects the type of adapter used for the primary monitor that must match your video display card and monitor.

[EGA / VGA]:	Enhanced Graphics Adapter/Video Graphics Array. For EGA, VGA, SVGA, or PGA monitor adapters.
[CGA 40]:	Color Graphics Adapter, power up in 40 column mode.
[CGA 80]:	Color Graphics Adapter, power up in 80 column mode.
[MONO]:	Monochrome adapter includes high resolution monochrome adapters.

■ Halt On [All Errors]

Set the system to halt on errors according to the system functions specified in each option. Configuration options: [All Errors] [No Errors] [All, But Keyboard]

3.2.3 Advanced BIOS Features

The "Advanced BIOS Features" screen appears when choosing the "Advanced BIOS Features" item from the "Initial Setup Screen" menu. It allows the user to configure the motherboard according to their particular requirements. Below are some major items that are provided in the Advanced BIOS features screen. A quick boot function is provided for your convenience. Simply enable the Quick Power On Self Test item to save time.

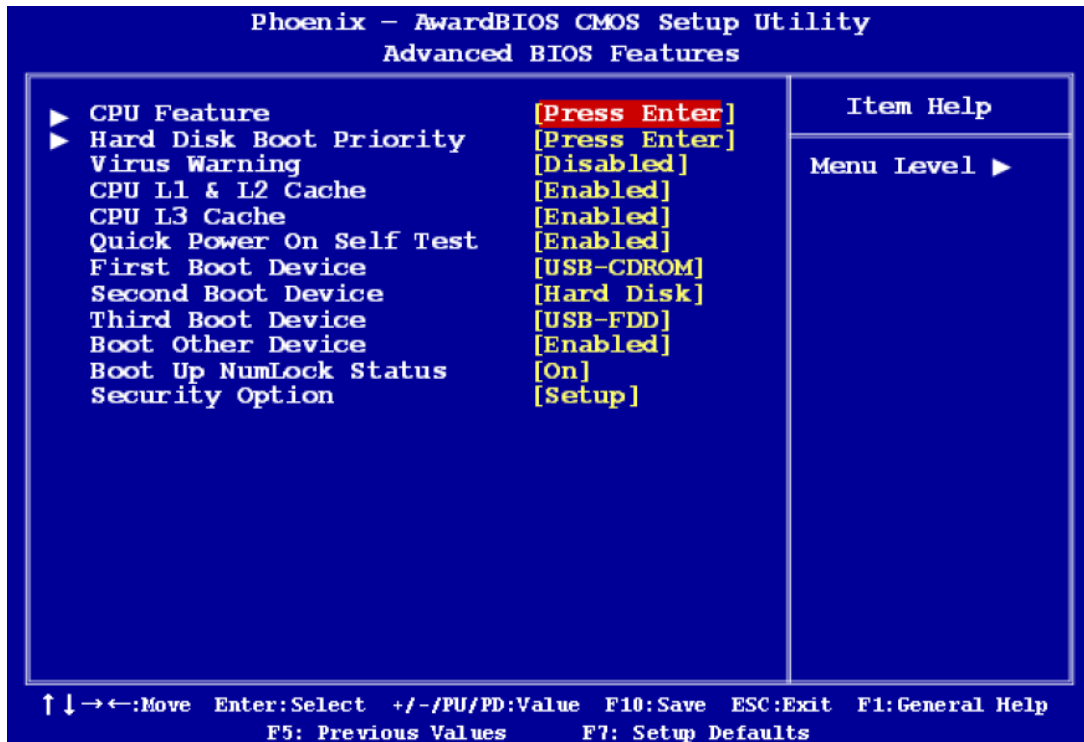

■ CPU Features

This item allows you to setup the CPU thermal management function.

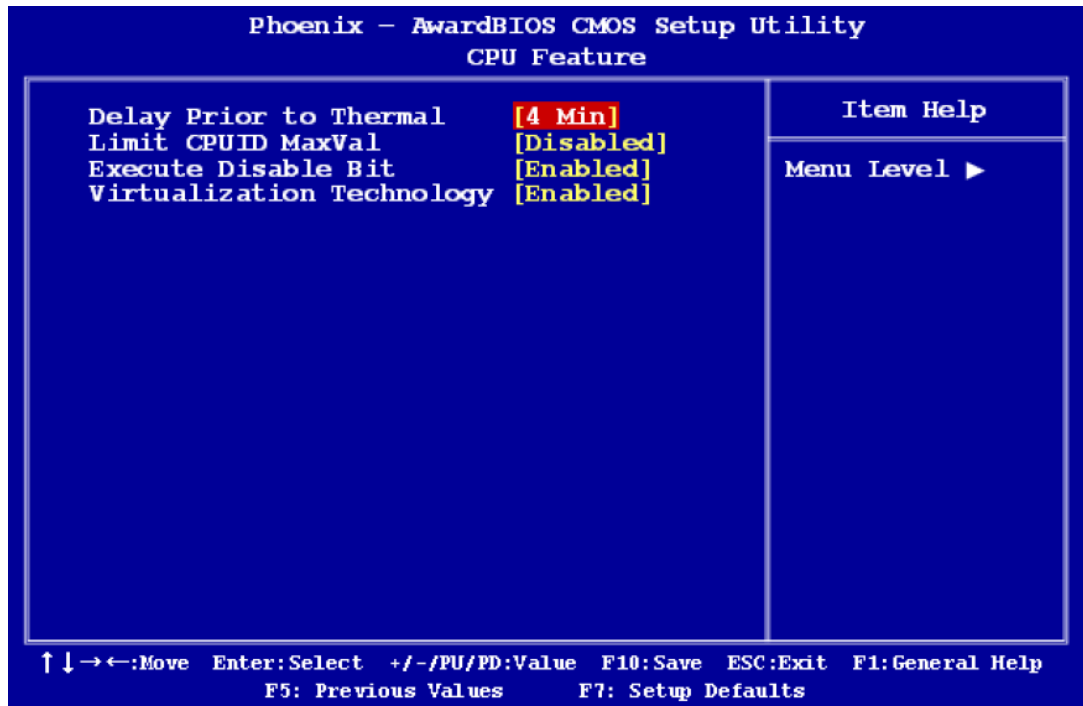

- **Delay Prior to Thermal [4 Min]**
 With the default value of 16 Minutes, the BIOS activates the Thermal Monitor in automatic mode 16 minutes after the system starts booting up
 The options: [4 Min], [8 Min], [16 Min], [32 Min].
- **Limit CPUID MaxVal [Disabled]**
 Sets Limit CPUID MaxVa1 to 3. This should be disabled for WinXP.
- **Execute Disabled Bit [Enabled]**
 When disabled, forces the XD feature flag to always return 0
- **Virtualization Technology [Enabled]**
 When enabled, a VMM can utilize the additional hardware capabilities provided by Vander pool Technology.

- **Hard Disk Boot Priority**
Set hard disk boot device priority.

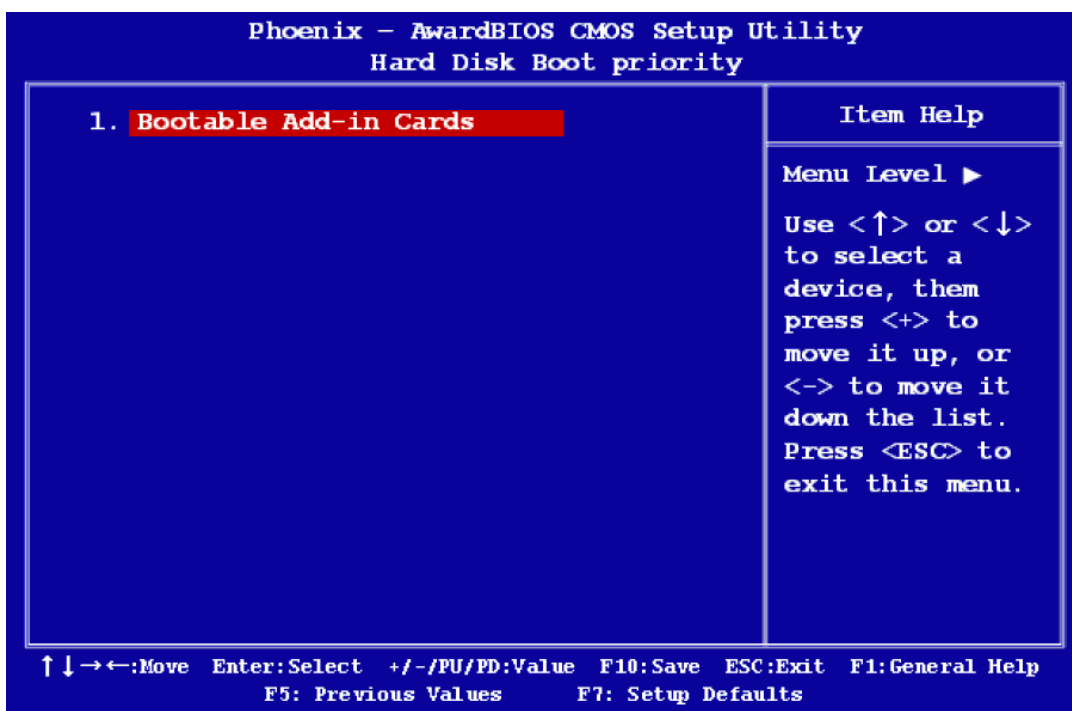

- **Virus [Disabled]**
Enables or disables the virus warning.

[Enabled]:	Activates automatically when the system boots up causing a warning message to appear when anything attempts to access the boot sector or hard disk partition table.
[Disabled]:	No warning message will appear when anything attempts to access the boot sector or hard disk partition table.
- **CPU L1 & L2 Cache [Enabled]**
Enabling this feature speeds up memory access. It can be set to Enabled or Disabled.
- **Quick Power On Self Test [Enabled]**
This allows the system to skip certain tests to speed up the boot-up procedure.

[Enabled]:	Normal POST
[Disabled]:	Enable quick POST
- **First / Second / Third Boot Device**
The BIOS tries to load the OS from the devices in the sequence set here. The options are: [Hard Disk], [USB-FDD], [USB-ZIP], [USB-CDROM], [Disabled]
- **Boot Other Device[Enabled]**
Use this to boot another device. The options are: [Disabled], [Enabled].

■ **Security Option[Disabled]**

This category determines whether the password is required when the system boots up or only when entering setup.

[System]:	The system will not boot and access to Setup will be denied if the correct password is not entered at the prompt.
[Setup]:	The system will boot, but access to Setup will be denied if the correct password is not entered at the prompt.

Note! *To disable security, select Set Supervisor Password at Main Menu and then you will be asked to enter password. Do not type anything and just press <Enter>, it will disable security. Once the security is disabled, the system will boot and you can enter Setup freely.*



3.2.4 Advanced Chipset Features

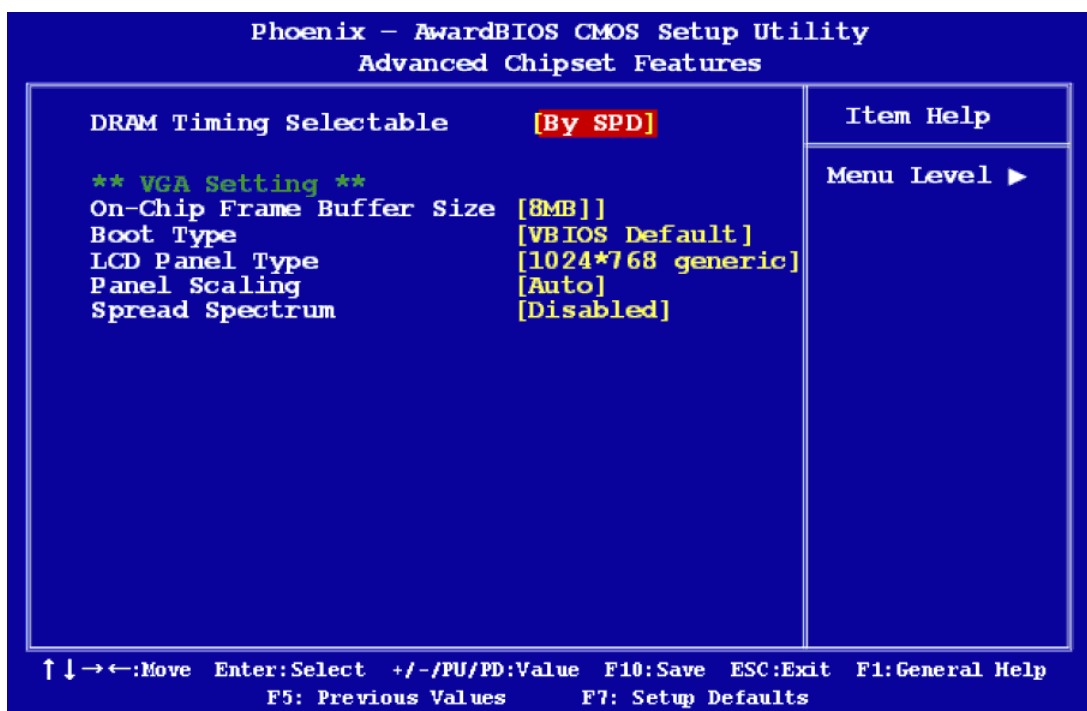

■ **DRAM Timing Selectable [By SPD]**

This item shows the DRAM timing value by SPD data or Manual.

■ **On-Chip Frame Buffer Size [8MB]**

The On-Chip Frame Buffer Size can be set to 1 MB or 8 MB. This memory is shared with the system memory.

■ **Boot Type [VBIOS Default]**

The options are: [VBIOS Default], [CRT], [LFP].

■ **LCD Panel Type [1280*768 generic]**

The options are:

- [640x480 generic]
- [800x600 generic]
- [1024x768 generic]
- [640x480 NEC 8.4"]
- [800x480 NEC 9"]

- [1024x600 TMD 5.61"]
- [1024x600 Samsung 4.8"]
- [1024x768 Samsung 15"]
- [1024x768 Sharp 7.2"]
- [1280x800 Samsung 15.4"]
- **Panel Scaling [Auto]**
The options are: [Auto], [Force], [Off]
- **Spread Spectrum [Disabled]**
This item enables users to set the spread spectrum modulation. The options are

3.2.5 Integrated Peripherals

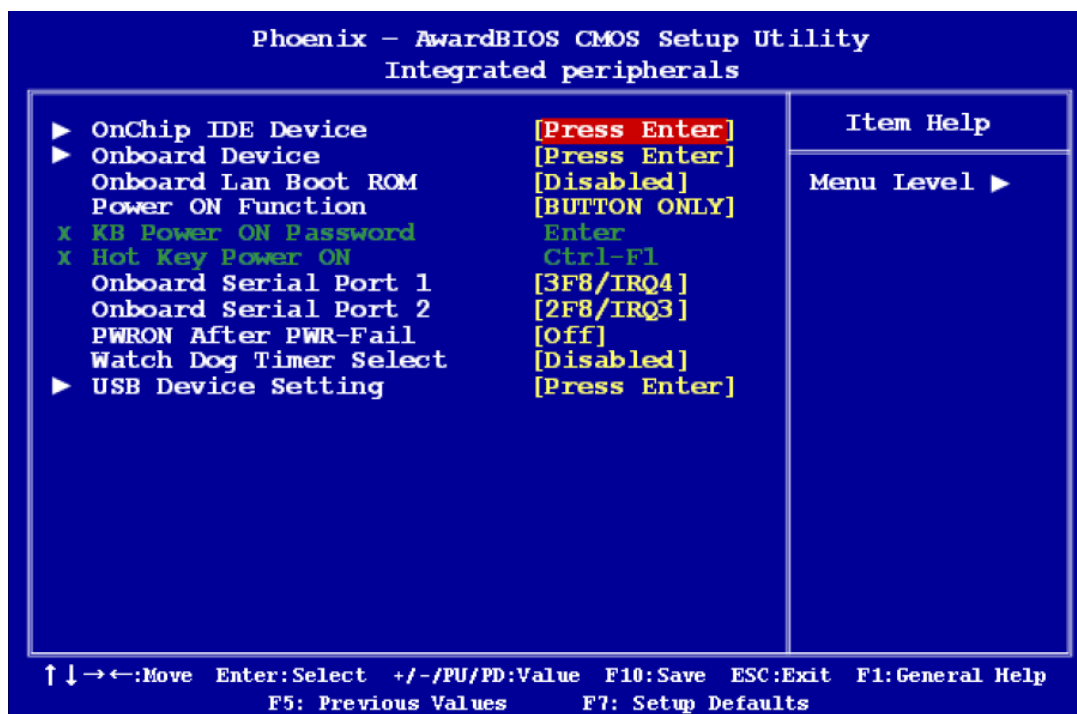

- OnChip IDE Device

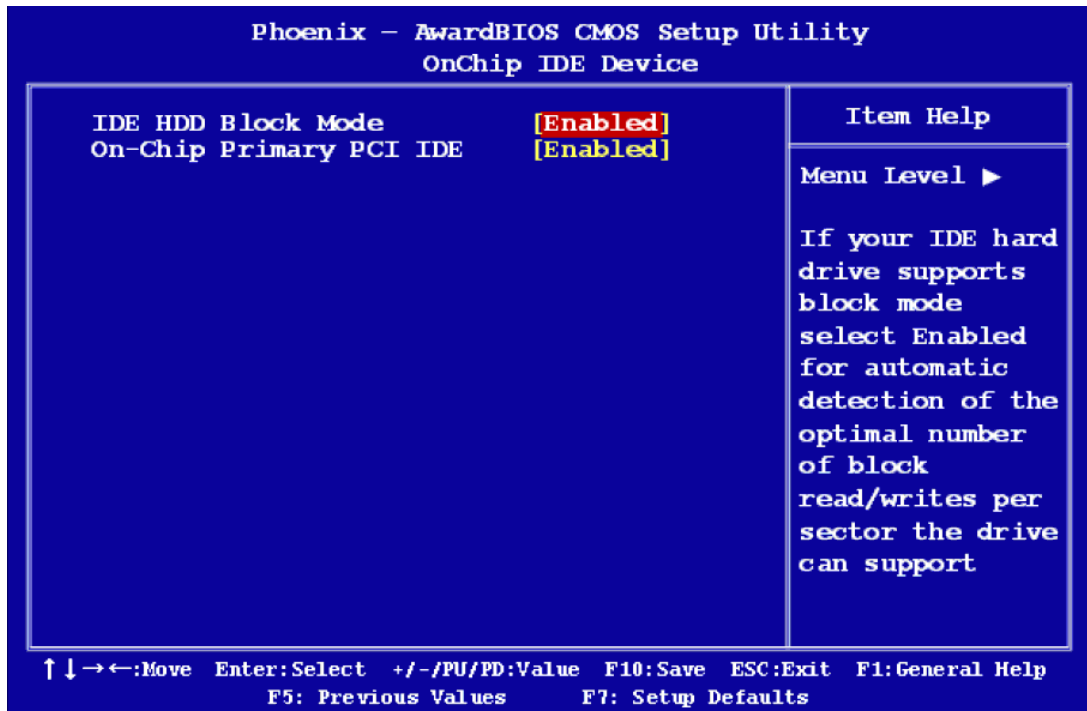

- IDE HDD Block Model [Enabled]

If the IDE hard drive supports block mode select Enabled for automatic detection of the optimal number of block read/writes per sector the drive can support.

- On-Chip Primary PCI IDE [Enabled]

The chipset contains a PCI IDE interface with support for two IDE channels. Select Enabled to activate the primary/secondary IDE interface. Select Disabled to deactivate this interface.

- Onboard Device

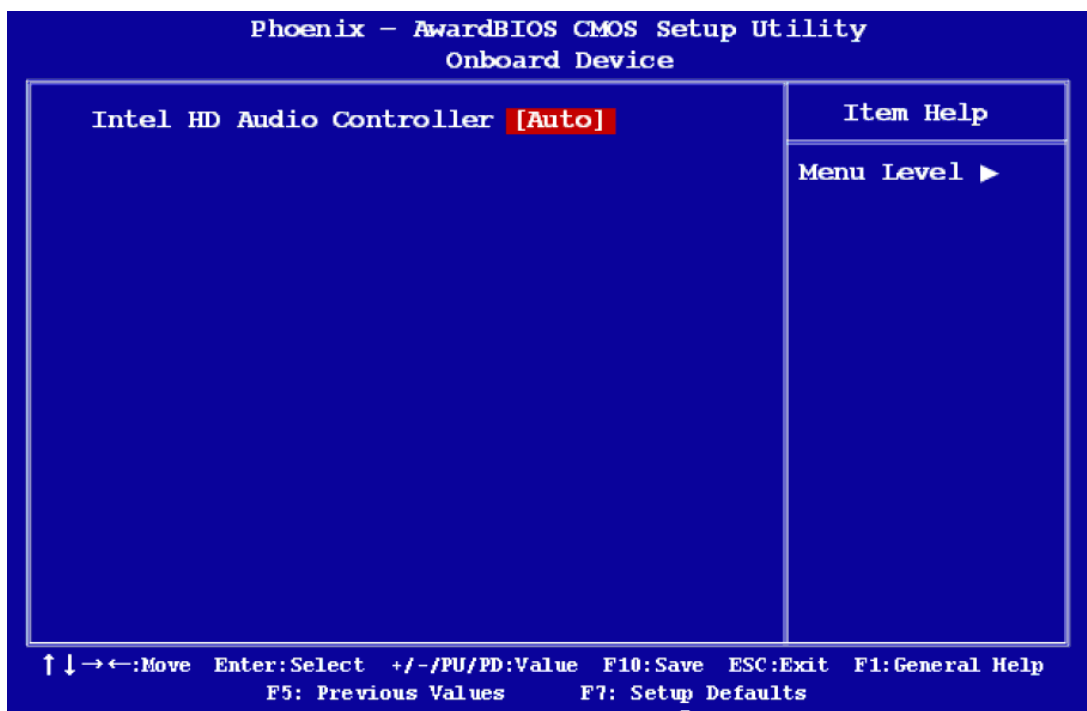

- **Intel HD Audio Controller** [Auto]
This item can disable the audio controller. The options are: [Auto], [Disabled].
- **Onboard LAN Boot ROM** [Enabled]
The options are: [Enabled], [Disabled].
- **Power ON Function** [Button Only]
This feature allows you to wake up the system using any of the listed options. The options: [Password], [Hot Key], [Mouse Left], [Mouse Right], [Any KEY], [Button Only], [Keyboard 98].
- **Onboard Serial Port 1/2**
This option is used to assign the I/O address and IRQ for the first and second serial port. The options are: [Disabled], [3F8/IRQ4], [2F8/IRQ3], [3E8/IRQ4], [2E8/IRQ3], [Auto]
- **PWRON After PWR-fail** [Off]
This item allows the user to select recovery after power fail function; this function depends on the chipset. The options are: [Off], [On], [Former-Sts]
- **Watch Dog Timer Select** [Disabled]
This option will determine watch dog timer. The choices: Disabled, 10, 20, 30, 40 Sec. 1, 2, 4 Min.

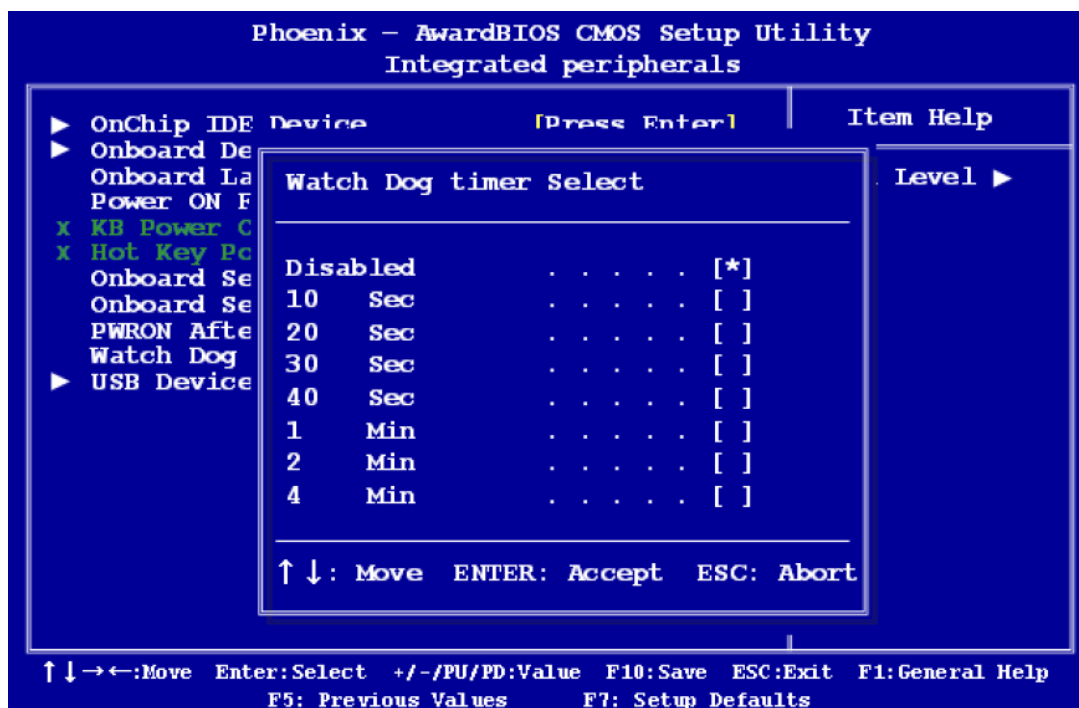

- **USB Device Setting**

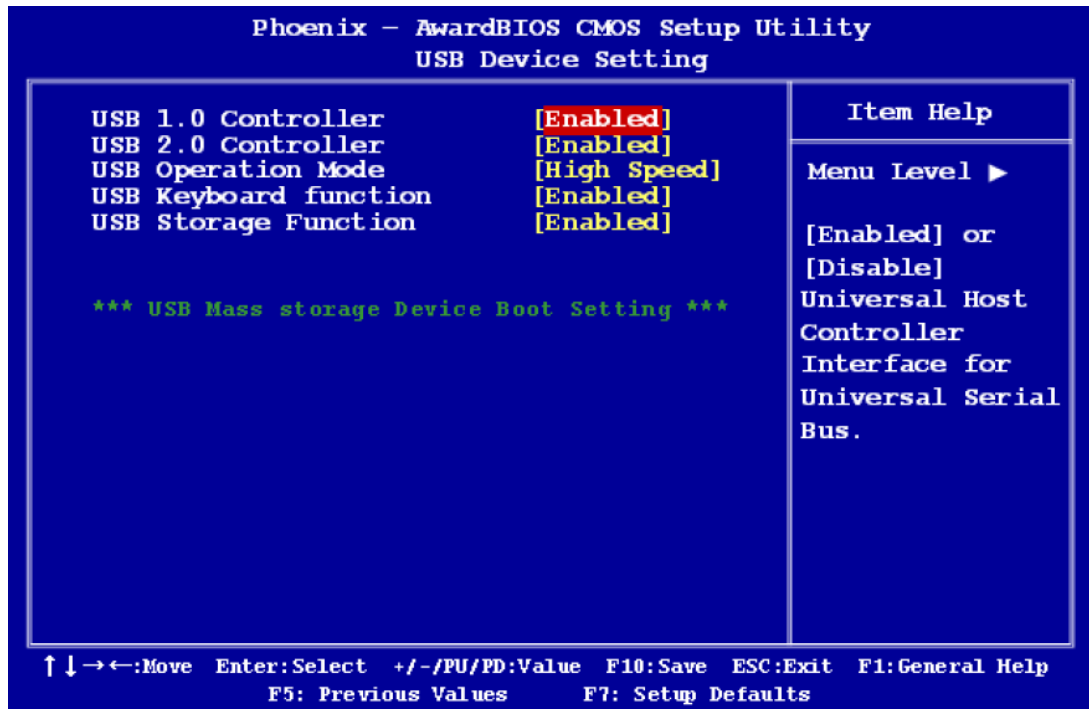

- **USB 1.0 / 2.0 Controller [Enabled]**
The options are: [Enabled], [Disabled].
- **USB Operation Mode [High Speed]**
Allows you to configure the USB 2.0 controller in HiSpeed (480 Mbps) or Full Speed (12 Mbps). Configuration options: [Full/Low Speed] [High Speed]
- **USB Keyboard Function [Enabled]**
The options are: [Enabled], [Disabled].
- **USB Storage Function**
The options are: [Enabled], [Disabled].

3.2.6 PnP/PCI Configurations

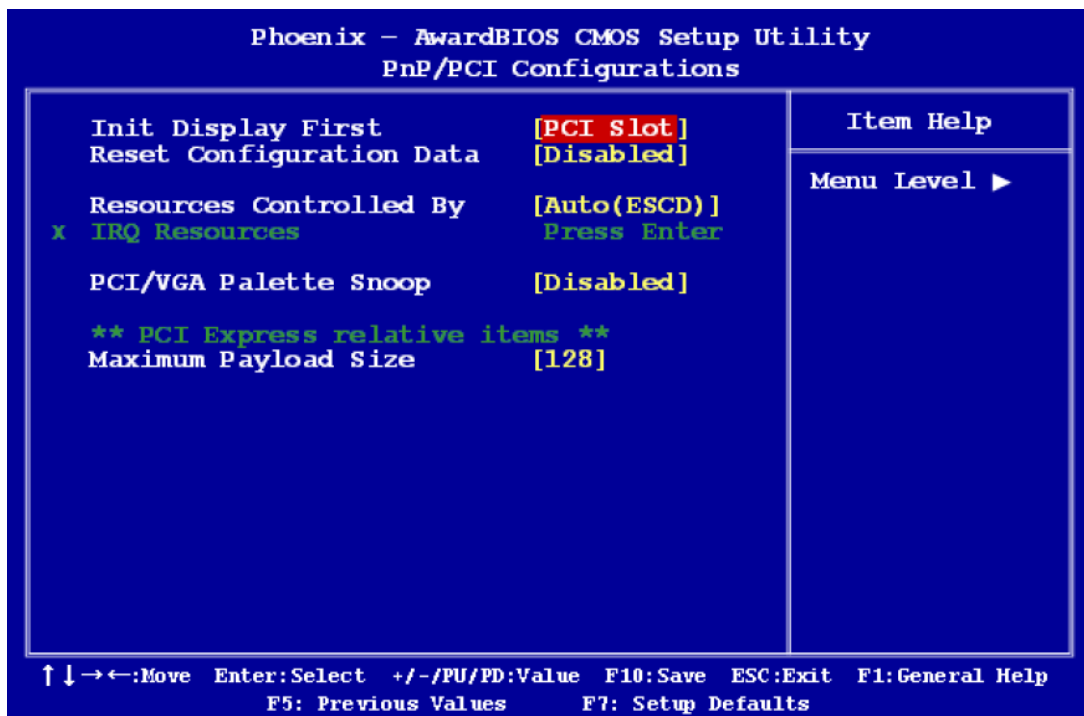

- **Init Display First [PCI Slot]**
The options are: [PCI slot], [Onboard], [PCIEx].
- **Rest Configuration Data [Disabled]**
The default is "Disabled". Select Enabled to reset Extended System Configuration Data (ESCD) if you have installed a new add-on card, and system reconfiguration has caused such a serious conflict that the OS cannot boot.
- **Resource Controlled By [Auto(ESCD)]**
The commands here are "Auto (ESCD)" or "Manual". Choosing "Manual" requires you to choose resources from the following sub-menu. "Auto (ESCD)" automatically configures all of the boot and Plug and Play devices, but you must be using Windows 95 or above.
- **PCI/VGA Palette Snoop [Disabled]**
This is set to "Disabled" by default. The options are: [Disabled], [Enabled].
- **Maximum Payload Size**
This allows you to set the maximum TLP payload size for PCI Express devices.

3.2.7 PC Health Status

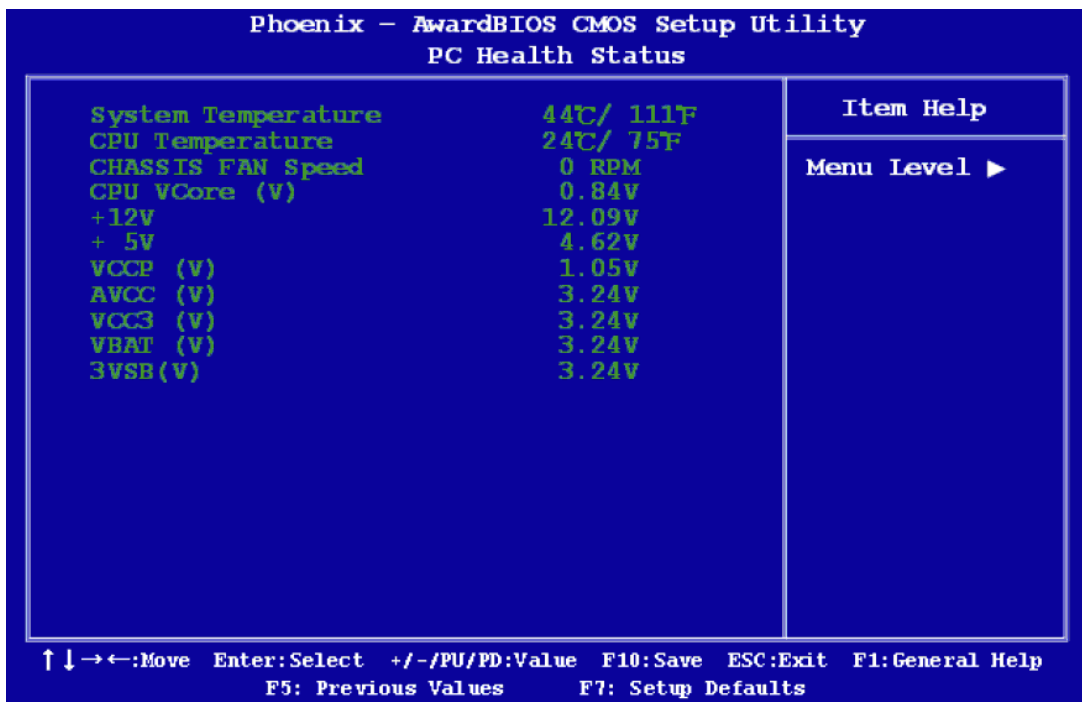

- **System Temperature**
This shows you the current temperature of the system.
- **CPU Temperature**
This shows the current CPU temperature.
- **VCore and Others Voltage**
This shows the voltage of VCORE, +5V, VCCP(V) and VCC3(V).

3.2.9 Set Supervisor Password

You can set supervisor password. It is able to enter/change the options of setup menus.

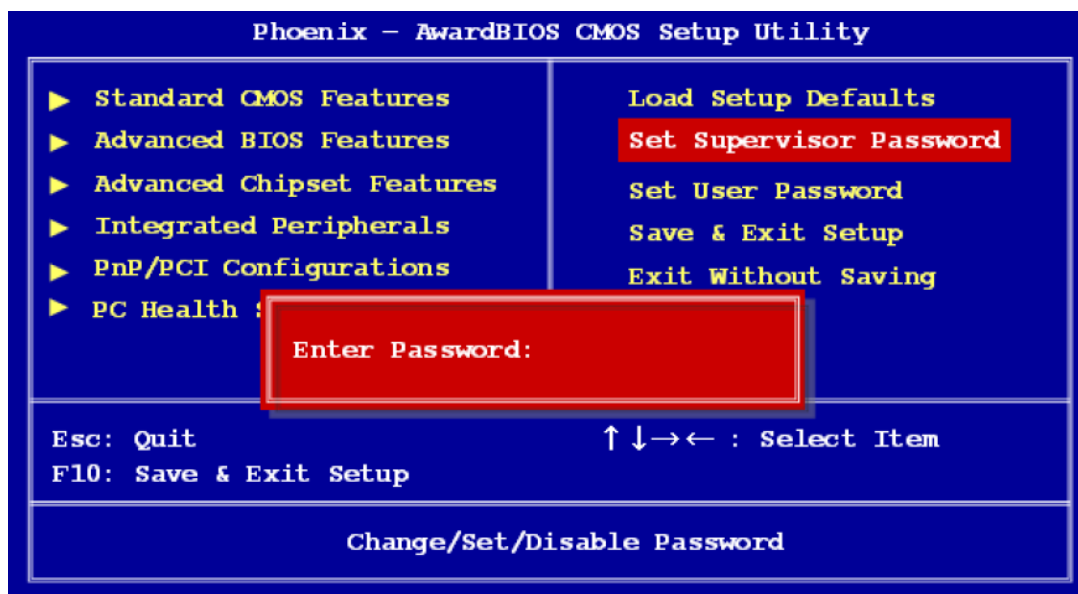

Follow these steps to change the password.

1. Choose the "Set Supervisor Password" option from the "Initial Setup Screen" menu and press <Enter>. The screen displays the following message:
2. Please <Enter Password>
3. Press <Enter>.
4. If the CMOS is good and this option has been used to change the default password, the user is asked for the password stored in the CMOS. The screen displays the following message:

Confirm Password
5. Type the current password and press <Enter>.
6. After pressing <Enter> (ROM password) or the current password (user-defined), you can change the password stored in the CMOS. The password must be no longer than eight (8) characters. Remember, to enable the password setting feature, you must first select either "Setup" or "System" from the "Advanced BIOS Features" menu.

3.2.10 Set User Password

You can set user password. It is able to enter/change the options of setup menus.

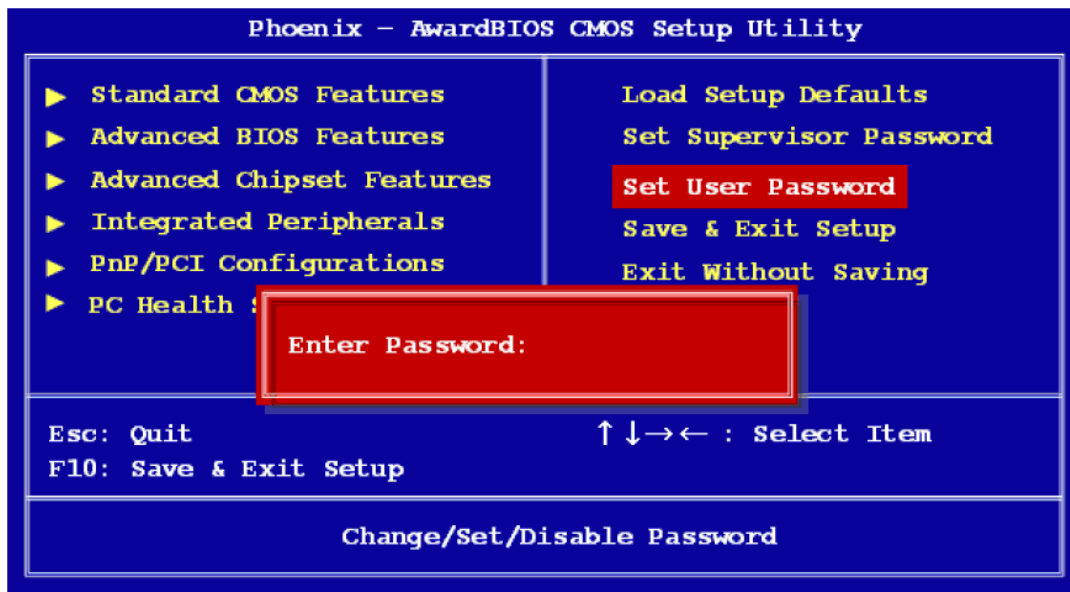

Follow these steps to change the password.

1. Choose the "Set User Password" option from the "Initial Setup Screen" menu and press <Enter>. The screen displays the following message:
2. Please <Enter Password>
3. Press <Enter>.
4. If the CMOS is good and this option has been used to change the default password, the user is asked for the password stored in the CMOS. The screen displays the following message:

Confirm Password

5. Type the current password and press <Enter>.
6. After pressing <Enter> (ROM password) or the current password (user-defined), you can change the password stored in the CMOS. The password must be no longer than eight (8) characters. Remember, to enable the password setting feature, you must first select either "Setup" or "System" from the "Advanced BIOS Features" menu.

3.2.11 Save and Exit Setup

If you select this and press <Enter>, the values entered in the setup utilities will be recorded in the CMOS memory of the chipset. The processor will check this every time you turn your system on and compare this to what it finds as it checks the system. This record is required for the system to operate.

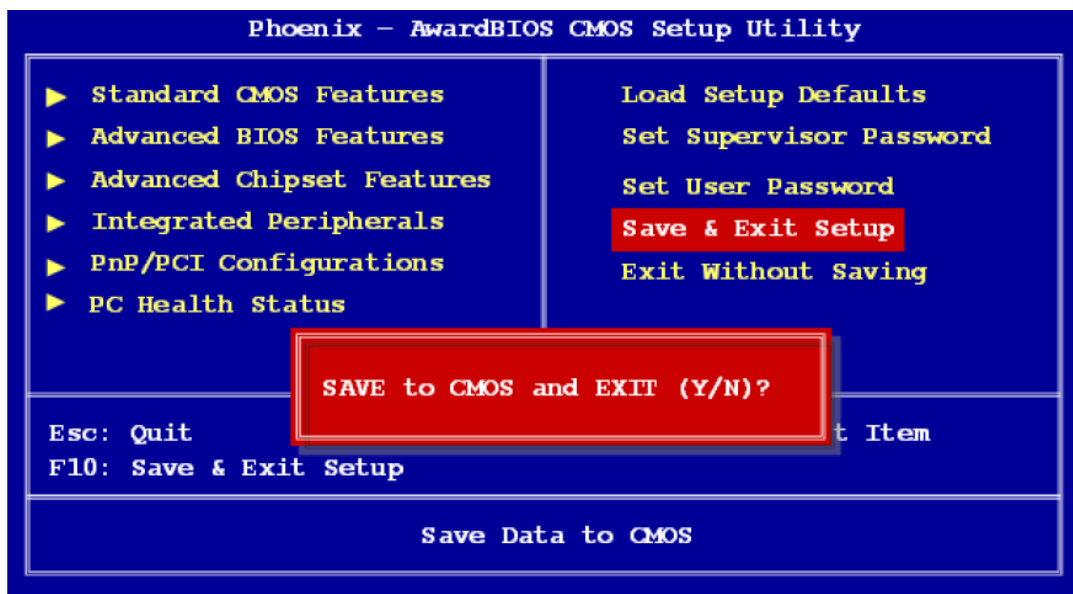

3.2.12 Exit Without Saving

Selecting this option and pressing <Enter> lets you exit the setup program without recording any new values or changing old ones.

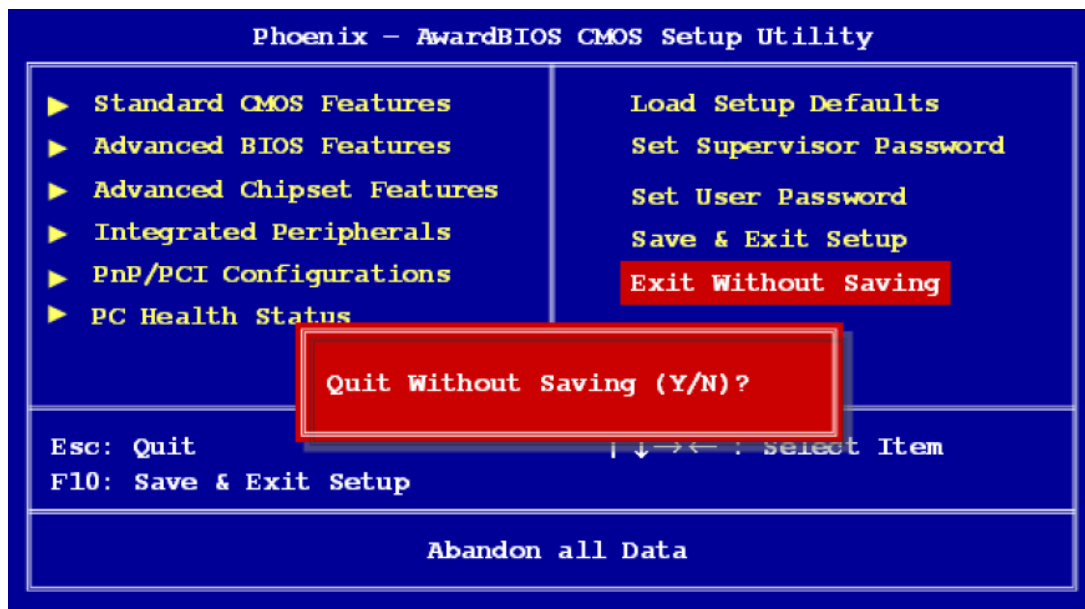

Appendix **A**

Adding miniPCle Card Procedure

A.1 Full disassembly procedure

If you want to add miniPCIe card or install miniPCIe interface module on ARK-1360, follow the step-by-step procedures below. Users should be aware that Advantech Co., Ltd. takes no responsibility whatsoever for any problems or damage caused by the user disassembly of ARK-1388. Make sure the power cord of ARK-1360 is unplugged before you start disassembly.

1. Unscrew the six screws and two hexagon posts on the front panel.



2. Unscrew the six screws and six hexagon posts on the rear panel.



3. Unscrew the four screws on the bottom side.



4. Take off the top chassis.

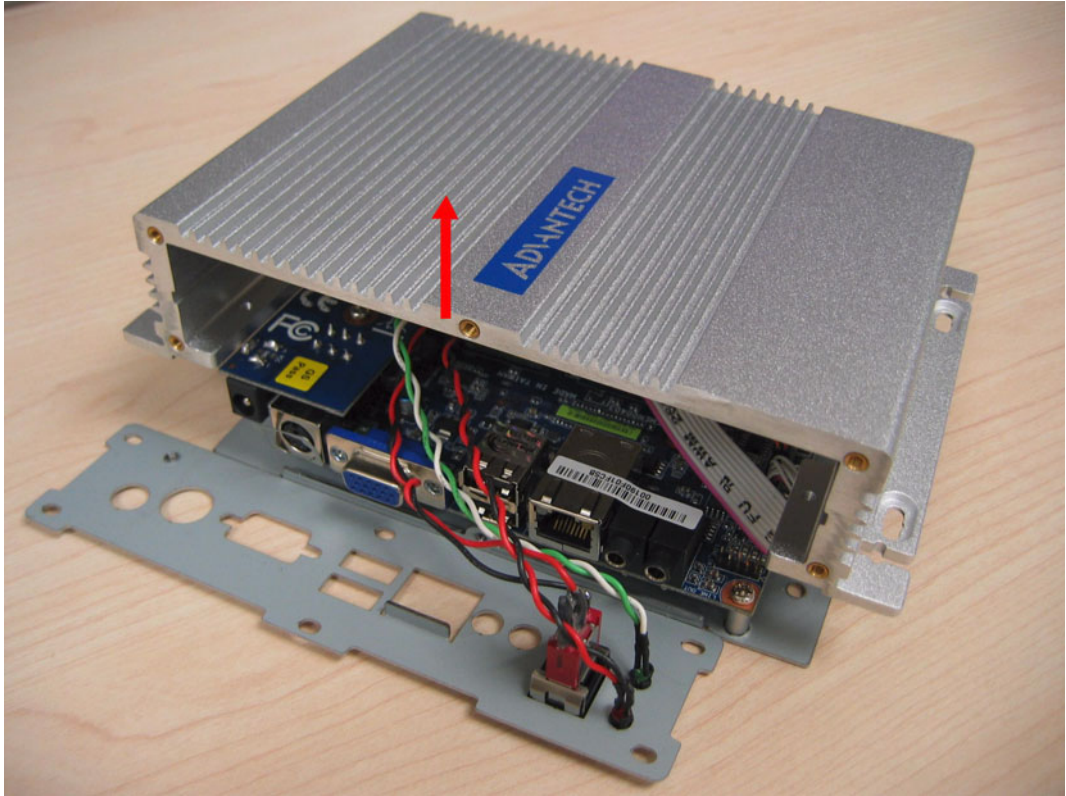

5. Now you can install a miniPCIe card on ARK-1360.

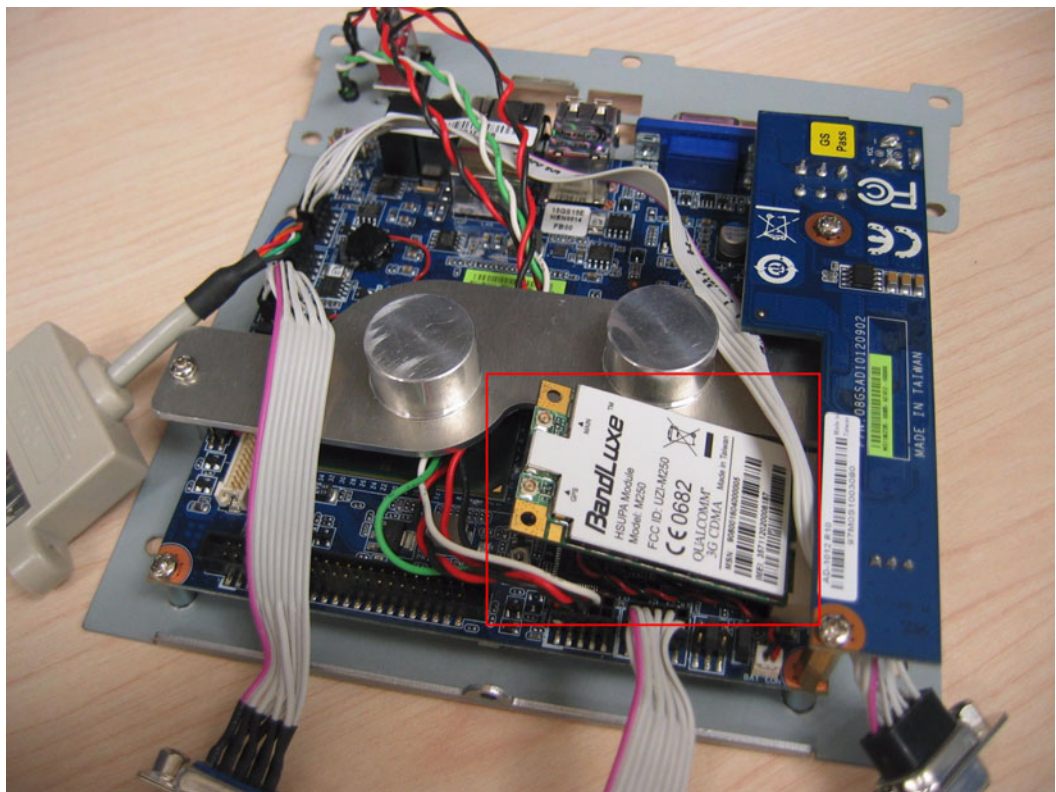

6. Screw a M2.5 screw on the miniPCle screw hole.

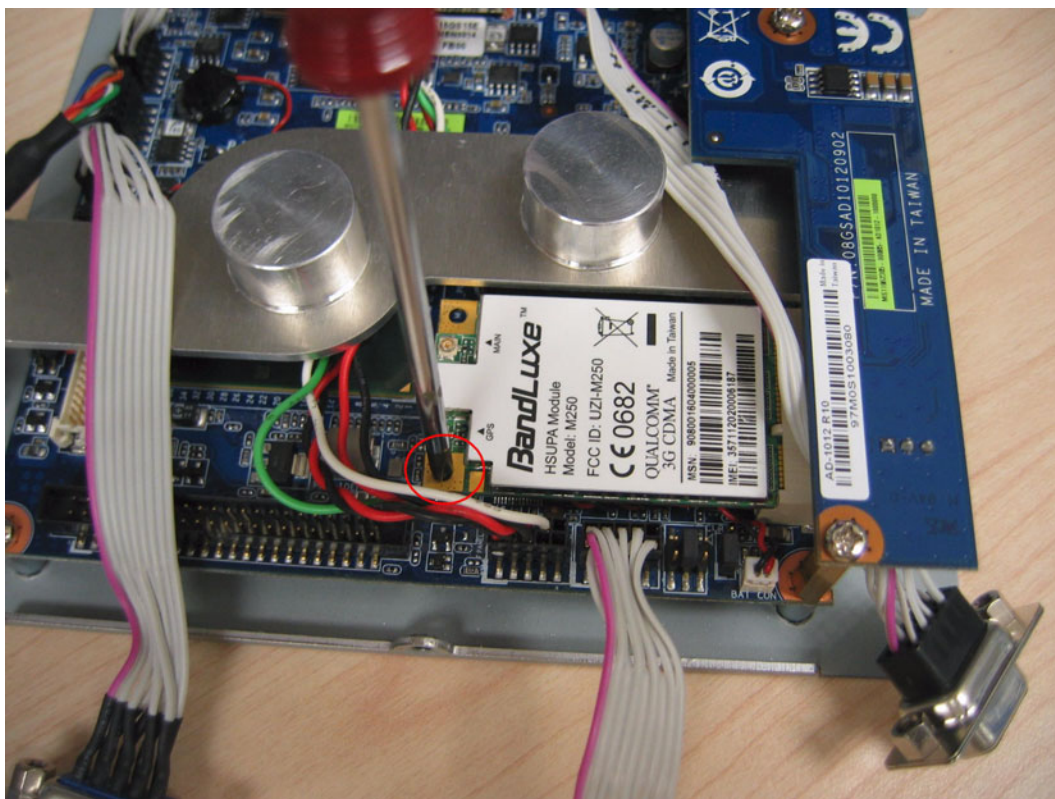

If an antenna is not needed for the miniPCle card, please skip the step 7 and 8.

7. Remove the cover of antenna on the rear panel.

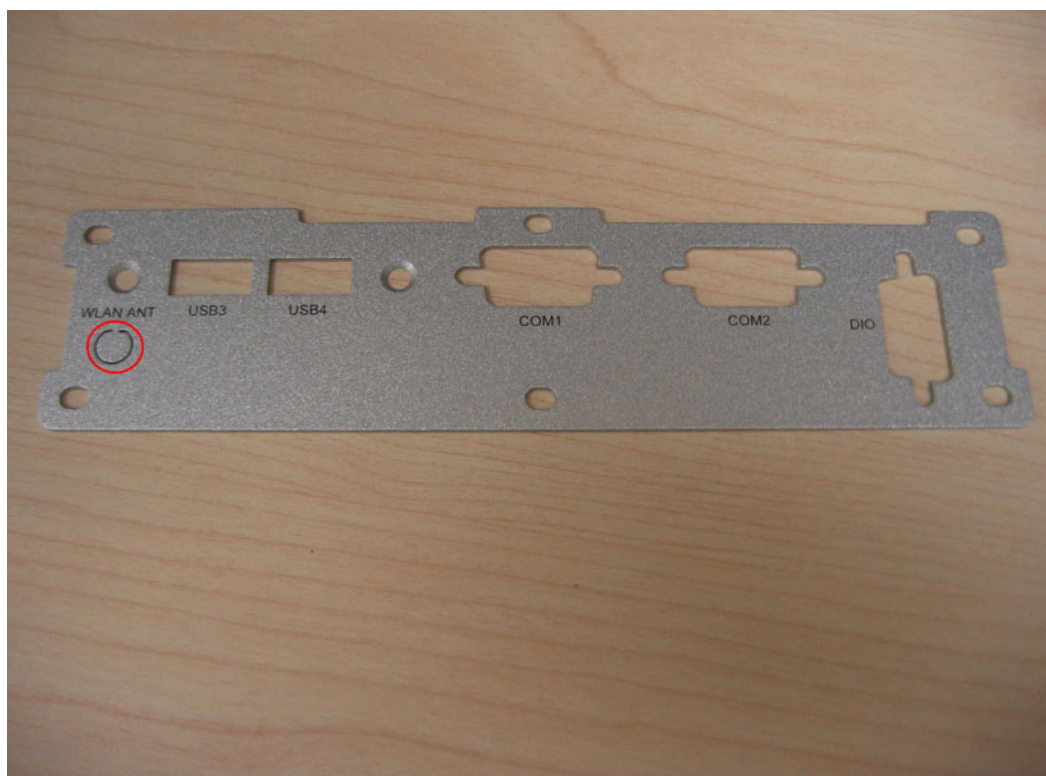

8. Set a SMA antenna cable on the rear panel.

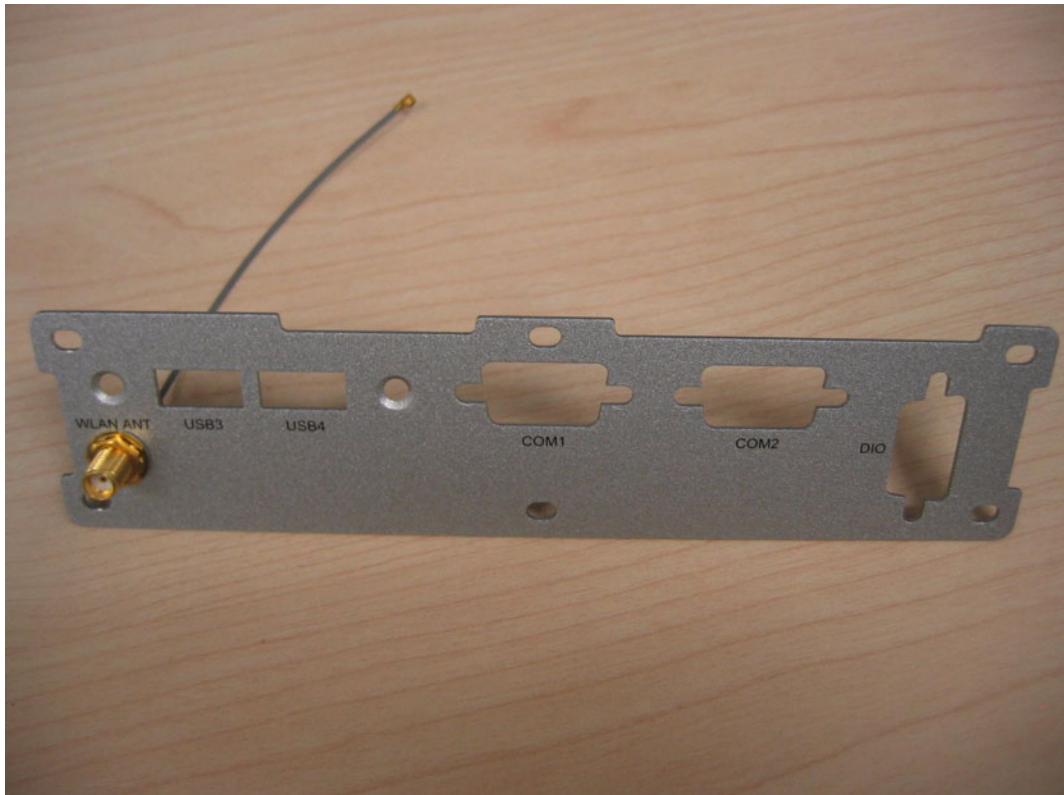

A.2 Full assembly procedure

1. Screw the six hexagon posts and two screws of the IO connectors.

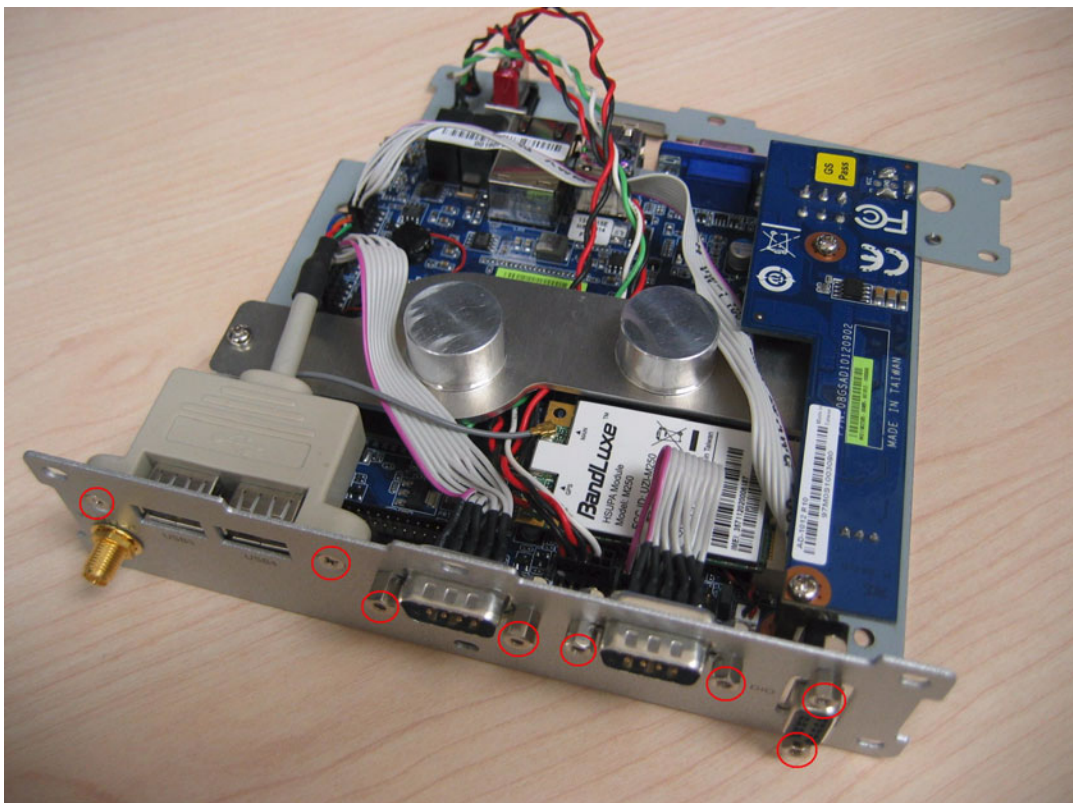

2. Put on the top chassis. Please be careful not tear the cables.



3. Screw the four screws on the bottom side.



Trusted ePlatform Services

ADVANTECH

www.advantech.com

Please verify specifications before quoting. This guide is intended for reference purposes only.

All product specifications are subject to change without notice.

No part of this publication may be reproduced in any form or by any means, electronic, photocopying, recording or otherwise, without prior written permission of the publisher.

All brand and product names are trademarks or registered trademarks of their respective companies.

© Advantech Co., Ltd. 2009