

PCI-COMM Series

**Industrial Serial Communication
Cards**

User Manual

Copyright

The documentation and the software included with this product are copyrighted 2008 by Advantech Co., Ltd. All rights are reserved. Advantech Co., Ltd. reserves the right to make improvements in the products described in this manual at any time without notice. No part of this manual may be reproduced, copied, translated or transmitted in any form or by any means without the prior written permission of Advantech Co., Ltd. Information provided in this manual is intended to be accurate and reliable. However, Advantech Co., Ltd. assumes no responsibility for its use, nor for any infringements of the rights of third parties, which may result from its use.

Acknowledgements

Award is a trademark of Award Software International, Inc.

VIA is a trademark of VIA Technologies, Inc.

IBM, PC/AT, PS/2 and VGA are trademarks of International Business Machines Corporation.

Intel and Pentium are trademarks of Intel Corporation.

Microsoft Windows® is a registered trademark of Microsoft Corp.

RTL is a trademark of Realtek Semi-Conductor Co., Ltd.

ESS is a trademark of ESS Technology, Inc.

UMC is a trademark of United Microelectronics Corporation.

SMI is a trademark of Silicon Motion, Inc.

Creative is a trademark of Creative Technology LTD.

All other product names or trademarks are properties of their respective owners.

Part No. 2003543502

6th Edition

Printed in Taiwan

October 2008

Product Warranty (2 years)

Advantech warrants to you, the original purchaser, that each of its products will be free from defects in materials and workmanship for two years from the date of purchase.

This warranty does not apply to any products which have been repaired or altered by persons other than repair personnel authorized by Advantech, or which have been subject to misuse, abuse, accident or improper installation. Advantech assumes no liability under the terms of this warranty as a consequence of such events.

Because of Advantech's high quality-control standards and rigorous testing, most of our customers never need to use our repair service. If an Advantech product is defective, it will be repaired or replaced at no charge during the warranty period. For out-of-warranty repairs, you will be billed according to the cost of replacement materials, service time and freight. Please consult your dealer for more details.

If you think you have a defective product, follow these steps:

1. Collect all the information about the problem encountered. (For example, CPU speed, Advantech products used, other hardware and software used, etc.) Note anything abnormal and list any onscreen messages you get when the problem occurs.
2. Call your dealer and describe the problem. Please have your manual, product, and any helpful information readily available.
3. If your product is diagnosed as defective, obtain an RMA (return merchandize authorization) number from your dealer. This allows us to process your return more quickly.
4. Carefully pack the defective product, a fully-completed Repair and Replacement Order Card and a photocopy proof of purchase date (such as your sales receipt) in a shippable container. A product returned without proof of the purchase date is not eligible for warranty service.

Write the RMA number visibly on the outside of the package and ship it prepaid to your dealer.

CE

This product has passed the CE test for environmental specifications when shielded cables are used for external wiring. We recommend the use of shielded cables. This kind of cable is available from Advantech. Please contact your local supplier for ordering information.

FCC Class A

This equipment has been tested and found to comply with the limits for a Class A digital device, pursuant to Part 15 of the FCC Rules. These limits are designed to provide reasonable protection against harmful interference when the equipment is operated in a commercial environment. This equipment generates, uses and can radiate radio frequency energy and, if not installed and used in accordance with the instruction manual, may cause harmful interference to radio communications. Operation of this equipment in a residential area is likely to cause harmful interference in which case the user will be required to correct the interference at his own expense.

Safety Precaution - Static Electricity

Follow these simple precautions to protect yourself from harm and the products from damage.

1. To avoid electrical shock, always disconnect the power from your PC chassis before you work on it. Don't touch any components on the CPU card or other cards while the PC is on.
2. Disconnect power before making any configuration changes. The sudden rush of power as you connect a jumper or install a card may damage sensitive electronic components.

Technical Support and Assistance

Step 1. Visit the Advantech web site at **www.advantech.com/support** where you can find the latest information about the product.

Step 2. Contact your distributor, sales representative, or Advantech's customer service center for technical support if you need additional assistance. Please have the following information ready before you call:

- Product name and serial number
- Description of your peripheral attachments
- Description of your software (operating system, version, application software, etc.)
- A complete description of the problem
- The exact wording of any error messages

Document Feedback

To assist us in making improvements to this manual, we would welcome comments and constructive criticism. Please send all such - in writing to: support@advantech.com

Contents

Chapter 1	Introduction	2
1.1	Description	2
1.2	Features	3
1.3	Specifications	3
1.4	Ordering Information	5
1.4.1	Accessories	7
	Table 1.1:PCI Communication Cards Selection Guide .	8
Chapter 2	Hardware Configuration	10
2.1	Initial Inspection.....	10
2.2	Jumper and Switch Locations	11
	Figure 2.1: PCI-1601A/B Silk Screen	11
	Figure 2.2:PCI-1601AU/BU Silk Screen	12
	Figure 2.3:PCI-1602A/B Silk Screen	13
	Figure 2.4:PCI-1602AU/BU Silk Screen	14
	Figure 2.5:PCI-1602UP Silk Screen	15
	Figure 2.6:PCI-1603 Silk Screen	16
	Figure 2.7:PCI-1604UP Silk Screen	17
	Figure 2.8:PCI-1610A/B Silk Screen	18
	Figure 2.9:PCI-1610CU Silk Screen	19
	Figure 2.10:PCI-1610AUP/UP Silk Screen	20
	Figure 2.11:PCI-1610AJP Silk Screen	21
	Figure 2.12:PCI-1611U Silk Screen	22
	Figure 2.13:PCI-1612A/B Silk Screen	23
	Figure 2.14:PCI-1612AU/U Silk Screen	24
	Figure 2.15:PCI-1612CU Silk Screen	25
	Figure 2.16:PCI-1620A/B Silk Screen	26
	Figure 2.17:PCI-1620AU/U Silk Screen	27
	Figure 2.18:PCI-1622CU Silk Screen	28
2.3	Jumper Settings	29
2.3.1	How to Set Jumpers	29
	Figure 2.19:How to Set Jumpers	29
2.3.2	Default Settings	30
	Table 2.1:PCI-1601/1602/1611/1612/1622 Default Setting	30
	Figure 2.20:PCI-1603 Default Setting	30
2.3.3	Mode Selection by Jumper/DIP Settings	31
	Figure 2.21:PCI-1612 Series RS-232/422/485 Selection	31
	Figure 2.22:RS-422/485 Selection by Jumper Setting .	31
	Figure 2.23:PCI-1603 RS-232 Mode Jumper Setting ..	32
	Figure 2.24:PCI-1603 Current-loop Mode Jumper Setting	32
	Figure 2.25:Active Mode Jumper Setting	32

		Figure 2.26:Passive Mode Jumper Setting	33
		Figure 2.27:Resistor Selection	34
	2.4	Card Installation	35
Chapter	3	Driver Setup & Installation.....	38
	3.1	Introduction	38
	3.2	Driver Setup	38
	3.2.1	Steps for Windows 98/2000/XP Driver Setup	38
	3.3	Reboot System after Win98/2000/XP Driver Setup	44
	3.3.1	PCI UARTs Device Driver Installation	44
	3.3.2	PCI Bridge Device Driver Installation	46
	3.4	Verify your Win98/2000/XP Driver Setup	47
	3.5	Configuring Serial Devices for Win 98/2000/XP	50
	3.5.1	Configuring a PCI UARTs Device	52
	3.5.2	Configuring a PCI Bridge Device	53
	3.5.3	Configuring Ports	53
	3.6	Remove PCI ICOM Series Device.....	54
	3.7	Driver Uninstall.....	57
Chapter	4	ICOM Tools	60
	4.1	Introduction	60
	4.2	Installation.....	60
	4.3	User Interface of ICOM Tools	61
	4.3.1	Menu Bar	61
	4.3.2	Tool Bar	62
	4.3.3	Com Port Tab	63
	4.3.4	Port Status	64
	4.3.5	Message Logo	64
	4.3.6	Tx Slide Bar	65
	4.3.7	Performance Listing Area	65
	4.3.8	Status Bar	65
	4.4	Using the ICOM Tools Utility	66
	4.4.1	Port Selection	66
		Figure 4.1:ICOM Tools program window	66
		Figure 4.2:Select Port dialog box	67
		Figure 4.3:Ports You Select Will Appear in the Selected Port Checkbox Group	67
		Figure 4.4:ICOM Tools User Interface	68
	4.4.2	Configuring a Port	68
		Figure 4.5:Test Information on the Performance Listing Area	69
	4.4.3	Close Port	70
	4.4.4	Exit the ICOM Tools utility	70
	4.5	Messages on Status Bar and Message Logo Area.....	71
	4.5.1	Status Bar Messages	71
	4.5.2	Message Logo Messages	72
Chapter	5	Pin Assignments and Wiring.....	74

5.1	Pin assignments	74
5.1.1	PCI-1601A/AU/B/BU, PCI-1602A/AU/B/BU	74
	Table 5.1:PCI-1601/1602 Male DB9 on bracket	74
	Figure 5.1:PCI-1601/1602 Pin Assignment	74
5.1.2	PCI-1602UP	75
	Table 5.2:PCI-1602UP Male DB9 on cable	75
	Table 5.3:PCI-1602UP Female DB25 on bracket	75
5.1.3	PCI-1603	76
	Table 5.4:PCI-1603 Male DB9 on bracket	76
5.1.4	PCI-1604UP	77
	Table 5.5:PCI-1604 Male DB9 on cable	77
	Table 5.6:PCI-1604UP Female DB25 on bracket	77
5.1.5	PCI-1610A/B/CU	78
	Table 5.7:PCI-1610A/B/CU Male DB9 on cable	78
	Table 5.8:PCI-1610A/B/CU male DB25 on cable	78
	Table 5.9:PCI-1610A/B/CU female DB37 on bracket	79
5.1.6	PCI-1610AUP/UP	80
	Table 5.10:PCI-1610AUP/UP male DB9 on cable	80
	Table 5.11:PCI-1610AUP/UP female DB44 on bracket	80
5.1.7	PCI-1610AJU	81
	Table 5.12:PCI-1610AJU male DB9 on cable	81
	Table 5.13:PCI-1610AJU RJ45 on bracket	81
5.1.8	PCI-1611U	82
	Table 5.14:PCI-1611U male DB9 on cable	82
	Table 5.15:PCI-1611U male DB25 on cable	82
	Table 5.16:PCI-1611U female DB37 on bracket	83
5.1.9	PCI-1612A/B/AU/U/CU	84
	Table 5.17:PCI-1612A/B/AU/U/CU male DB9 on cable	84
	Table 5.18:PCI-1612A/B/AU/U/CU male DB25 on cable	84
	Table 5.19:PCI-1612A/B/AU/U/CU female DB37 on bracket	85
5.1.10	PCI-1620A/B/AU/U	86
	Table 5.20:PCI-1620A/B/AU/U female DB62 on bracket	86
	Table 5.21:PCI-1620A/B/AU/U male DB9 on cable (OPT8H)	87
	Table 5.22:PCI-1620A/B/AU/U male DB25 on cable (OPT8BP,OPT8C)	87
	Table 5.23:PCI-1620A/B/AU/U female DB25 on cable (OPT8AP)	88
	Table 5.24:PCI-1620A/B/AU/U female DB25 on cable (OPT8FP)	88
5.1.11	PCI-1622CU	89
	Table 5.25:PCI-1622CU male DB9 on cable (OPT8J)	89
	Table 5.26:PCI-1622CU male DB25 on cable(OPT8I)	89
	Table 5.27:PCI-1622CU female DB78 on bracket	90
5.2	Wiring	92
5.2.1	RS-232 Signal Wiring	92

	Table 5.28:Terminal or PC (DTE) Connections	92
	Table 5.29:Modem Connections	93
	Table 5.30:Terminal without Handshake	93
5.2.2	RS-422 Signal Wiring	94
	Table 5.31:RS-422 DB9 Pin Assignment	94
5.2.3	RS-485 Signal Wiring	95
	Figure 5.2:RS-485 Wiring Topology	95

Introduction

This chapter provides detailed specifications for the PCI COMMUNICATION cards.

Sections include:

- Description
- Features
- Specifications
- Ordering Information
- Selection Guide

Chapter 1 Introduction

1.1 Description

The PCI Local Bus is a high-performance bus that provides a processor-independent data path between the CPU and high-speed peripherals. PCI is a robust inter-connect mechanism designed specifically to accommodate multiple high performance peripherals for series communication, SCSI, LAN, etc.

Advantech serial communication card leverages the " Plug and Play " capability defined in the PCI 2.1/2.2 bus specification. The board requires only one PCI slot within the personal computer and provides independent serial channels. All channels are addressed in a continuous 32 byte I/O block for simplified software access. And, all channels may also share one PCI interrupt. An interrupt status register is available for determining the interrupt source.

The Advantech PCI communication card comes standard with 16PCI952/954 UARTs containing 128 byte FIFOs which are available as an option. These upgraded FIFOs greatly reduce CPU overhead and are an ideal choice for heavy multitasking environments.

16PCI952/954

The 16PCI952/954 is a high performance Twin/Quad UART with an on-chip PCI interface. Targeted at PCI-based serial and parallel expansion cards, PCI-architecture computer systems and embedded applications, the 16PCI952/954 integrates a PCI bus interface together with two/four of 16C950 high performance UARTs, a bi-directional parallel port and a local bus bridge function. This single-chip solution replaces five or more integrated circuits used in today products, giving performance, cost and size advantages for new designs.

1.2 Features

- PCI Specification 2.1/2.2 compliant
- Speeds up to 921.6 kbps
- 16PCI952/954 , 16C954 UARTs with 128-byte FIFOs standard
- I/O address automatically assigned by PCI plug-and play
- OS supported: Windows 98/ME/2000/XP, Linux
- Optional surge protection
- Optional isolation protection for RS-232/422/485
- Interrupt status register for increased performance
- Space reserved for termination resistors
- Automatic RS-485 data flow control
- Utility-ICOM Tools

1.3 Specifications

- **Bus Interface:**
PCI bus specification 2.1 compliant for: PCI-1601A/B, PCI-1602A/B, PCI-1610A/B, PCI-1612A/B, and PCI-1620A/B.
PCI bus specification 2.2 compliant for: PCI-1601AU/BU, PCI-1602AU/BU, PCI-1602UP, PCI-1603, PCI-1604UP, PCI-1610CU/AJU/AUP/UP, PCI-1611U, PCI-1612AU/U/CU, PCI-1620AU/U and PCI-1622CU
- **IRQ:** all ports use the same IRQ assigned by PCI Plug-and-Play
- **Data bits:** 5, 6, 7, 8
- **Stop bits:** 1, 1.5, 2
- **Parity:** none, even, odd
- **Communication Controller:**
16PCI954 + 16C954 for PCI-1620A/B/AU/U and PCI-1622CU

16PCI954 for PCI-1610A/AJU/B/CU/AUP/UP, PCI-1611U and PCI-1612A/B/AU/U/CU

16PCI952 for PCI-1601A/AU/B/BU, PCI-1602A/AU/B/BU/UP, PCI-1603 and PCI-1604UP

- **Speed (bps) :**

PCI-1603: RS-232: 50~203.4k

Current Loop: 50~57.6k

Others: 50 ~ 921.6 k

- **Data Signals:**

TxD, RxD, RTS, CTS, DTR, DSR, DCD, GND (for RS-232)

RI (for PCI-1603, PCI-1604UP, PCI-1610A/AJU/B/CU/AUP/UP)

TxD, RxD, RTS, CTS (for RS-422/485)

Tx+, Tx-, Rx+, Rx- (for PCI-1603 Current loop)

Data+, Data-, GND (for PCI-1602UP RS-485)

TxD, RxD, Rx+, Rx-, RTS+, RTS-, CTS+, CTS-, GND (for PCI-1602UP RS-422)

- **Dimensions:**

185 x 100 mm (for PCI-1610CU, PCI-1611U, PCI-1612A/B/AU/U/
CU, PCI-1620A/B/AU/U, PCI-1622CU)

123 x 92 mm (for PCI-1601A/AU/B/BU, PCI-1602A/AU/B/BU, PCI-1603, and PCI-1610A/AJU/B)

119.91x 64.41mm (Low Profile PCI MD1 for PCI-1602UP, PCI-1604UP and PCI-1610AUP/UP)

- **Power Consumption**

Model	Typical	Max
PCI-1601A/AU/B/BU	220 mA (+5V)	270 mA (+5V)
PCI-1602A/AU/B/BU	250 mA (+5V)	300 mA (+5V)
PCI-1602UP	-	300 mA (+5V)
PCI-1603	250 mA (+5V)	300 mA (+5V)
PCI-1604UP	-	300 mA (+5V)
PCI-1610A/B	60 mA (+12 V)	80 mA (+12 V)
	150 mA (+5 V)	180 mA (+5 V)
PCI-1610CU	-	750mA(+5V)
PCI-1610AJU/AUP/UP	-	400 mA (+5V)
PCI-1611U	-	600mA(+5V)
PCI-1612A/B/AU/U	270 mA (+5 V)	338 mA (+5 V)
PCI-1612CU	758 mA (+5V)	803 mA (+5V)
PCI-1620A/B/AU/U	120 mA (+12 V)	150 mA (+12 V)
	180 mA (+5 V)	220 mA (+5 V)
PCI-1622CU	-	600mA(+5V)

- **Operating Temperature:** 0~ 65° C (See IEC 68-2-1, 2), (32~149° F)
- **Operating Humidity:** 5 ~ 95% Relative Humidity, non-condensing (See IEC 68-2-3)
- **Storage Temperature:** -25 ~ 85° C (-13~185° F)
- **Current-loop Interface**
Signal Driver/receiver: 6N136
Signals: TxD+, TxD-, RxD+, RxD-
- **Current Value:** 20mA (Standard)
- **Mode:** Asynchronous, full duplex
- **Baud-rate:** 50 ~ 57600 bps
- **Transmission Distance:** 1000 m

1.4 Ordering Information

- **PCI-1601A:** 2-port RS-422/485 PCI Comm. Card
- **PCI-1601AU:** 2-port RS-422/485 Universal PCI Comm. Card
- **PCI-1601B:** 2-port RS-422/485 PCI Comm. Card, w/surge protection
- **PCI-1601BU:** 2-port RS-422/485 Universal PCI Comm. Card w/surge protection
- **PCI-1602A:** 2-port RS-422/485 PCI Comm. Card. w/ isolation protection
- **PCI-1602AU:** 2-port RS-422/485 Universal PCI Comm. Card w/ isolation
- **PCI-1602B:** 2-port RS-422/485 PCI Comm. Card, w/isolation and surge protection
- **PCI-1602BU:** 2-port RS-422/485 Universal PCI Comm. Card w/ isolation and surge protection
- **PCI-1602UP:** 2-port RS-422/485 Low-Profile Universal PCI Comm. Card, w/isolation and surge protection
- **PCI-1603:** 2-port Isolated RS-232/current-loop PCI Comm. Card
- **PCI-1604UP:** 2-port RS-232 Low-Profile Universal PCI Comm. Card, w/surge protection
- **PCI-1610A:** 4-port RS-232 PCI Comm. Card

- **PCI-1610AJU:** 4-port RS-232 Universal PCI Comm. Card w/ RJ45 connector
- **PCI-1610AUP:** 4-port RS-232 Low-Profile Universal PCI Comm. Card
- **PCI-1610B:** 4-port RS-232 PCI Comm. Card, w/surge protection
- **PCI-1610CU:** 4-port RS-232 Universal PCI Comm. Card, w/isolation and surge protection
- **PCI-1610UP:** 4-port RS-232 Low-Profile Universal PCI Comm. Card, w/surge protection
- **PCI-1611U:** 4-port RS-422/485 Universal PCI Comm. Card, w/isolation and surge protection
- **PCI-1612A:** 4-port RS-232/422/485 PCI Comm. Card
- **PCI-1612AU:** 4-port RS-232/422/485 Universal PCI Comm. Card
- **PCI-1612B:** 4-port RS-232/422/485 PCI Comm. Card, w/surge protection
- **PCI-1612CU:** 4-port RS-232/422/485 Universal PCI Comm. Card, w/isolation and surge protection
- **PCI-1612U:** 4-port RS-232/422/485 Universal PCI Comm. Card, w/surge protection
- **PCI-1620A:** 8-port RS-232 PCI Comm. Card
- **PCI-1620AU:** 8-port RS-232 Universal PCI Comm. Card
- **PCI-1620B:** 8-port RS-232 PCI Comm. Card, w/surge protection
- **PCI-1620U:** 8-port RS-232 Universal PCI Comm. Card, w/surge protection
- **PCI-1622CU:** 8-port RS-422/485 Universal PCI Comm. Card, w/isolation and surge protection

1.4.1 Accessories

- **OPT8AP:** 8-Port RS-232 Connection Box/Female DB25 Connectors (DCE) (1 m cable connectors with card and connection box included)
- **OPT8ASP:** 8-Port RS-232 Connection Box/Female DB25 Connectorsw/ surge protection (DCE) (1m cable connectors with card and connection box included)
- **OPT8BP:** 8-Port RS-232 Connection Box/Male DB25 Connectors (DTE) (1 m cable connectos with card and connection box included)
- **OPT8BSP:** 8-Port RS-232 Connection Box/Male DB25 Connector w/ surge protection (DTE) (1 m cable connectors with card and connection BOX included)
- **OPT8C:** 8-Port RS-232 Octopus Cable/Male DB25 Connect 1 m
- **OPT8H:** 8-Port RS-232 Octopus Cable/Male DB9 Connect 1 m
- **OPT8I:** 1 m female DB78 to 8* male DB25 cable (To be used with PCI-1622CU)
- **OPT8J:** 1 m female DB9 to 8* male DB25 cable (To be used with PCI-1622CU)
- **OPT8FP:** 8-port RS-422 to RS-232 converter connection box with isolation protection (1 m cable connectors with card and connection box included)

Table 1.1: PCI Communication Cards Selection Guide

Model Name		Form Factor	Ports	Comm. Interface Support	Protection	
					Surge	Isolation
PCI-1601	A	-	2	RS-422/485	-	-
	B	-			2500V _{DC}	-
	AU	Universal			-	-
	BU	Universal			2500V _{DC}	-
PCI-1602	A	-			-	3000V _{DC}
	B	-			2500V _{DC}	3000V _{DC}
	AU	Universal			-	3000V _{DC}
	BU	Universal			2500V _{DC}	3000V _{DC}
	UP	Low-Profile/Universal			2500V _{DC}	2500V _{DC}
PCI-1603		Universal			RS-232/Current loop	-
PCI-1604UP		Low-Profile/Universal	RS-232	2500V _{DC}	-	
PCI-1610	A	-	4	RS-232	-	-
	B	-			3000V _{DC}	-
	CU	Universal			2500V _{DC}	2500V _{DC}
	AJU	Universal			-	-
	AUP	Low-Profile/Universal			-	-
	UP	Low-Profile/Universal			2500V _{DC}	-
PCI-1611U		Universal	RS-422/485	2500V _{DC}	2000V _{DC}	
PCI-1612	A	-	RS-232/422/485	-	-	
	B	-		2500V _{DC}	-	
	AU	Universal		-	-	
	U	Universal		2500V _{DC}	-	
	CU	Universal		2500V _{DC}	2500V _{DC}	
PCI-1620	A	-	8	RS-232	-	-
	B	-			3000V _{DC}	-
	AU	Universal			-	-
	U	Universal			2500V _{DC}	-
PCI-1622CU		Universal	RS-422/485	2500V _{DC}	2500V _{DC}	

Hardware Configuration

This chapter provides information on the hardware configuration of PCI COMMUNICATION cards.

Sections include:

- Initial Inspection
- Jumper and Switch Locations
- Jumper Settings
- Card Installation

Chapter 2 Hardware Configuration

2.1 Initial Inspection

You should find the following items inside the shipping package:

PCI communication interface card

Industrial Communication Driver, Utility and PCI communication card user manual in ICOM CD-ROM

We carefully inspected the PCI communication card series mechanically and electrically before we shipped it. It should be free of marks and scratches and in perfect working order on receipt.

As you unpack the PCI communication card series, check it for signs of shipping damage (damaged box, scratches, dents, etc.). If it is damaged or it fails to meet specifications, notify our service department or your local sales representative immediately. Also notify the carrier. Retain the shipping carton and packing material for inspection by the carrier. After inspection we will make arrangements to repair or replace the unit.

When you handle the PCI communication card series, remove it from its protective packaging by grasping the rear metal panel. Keep the anti-vibration packing. Whenever you remove the card from the PC, store it in this package for protection.

Warning! *Discharge your body's static electric charge by touching the back of the grounded chassis of the system unit (metal) before handling the board. You should avoid contact with materials that hold a static charge such as plastic, vinyl and styrofoam. Handle the board only by its edges to avoid static damage to its integrated circuits. Avoid touching the exposed circuit connectors. We also recommend that you use a grounded wrist strap and place the card on a static dissipative mat whenever you work with it.*



2.2 Jumper and Switch Locations

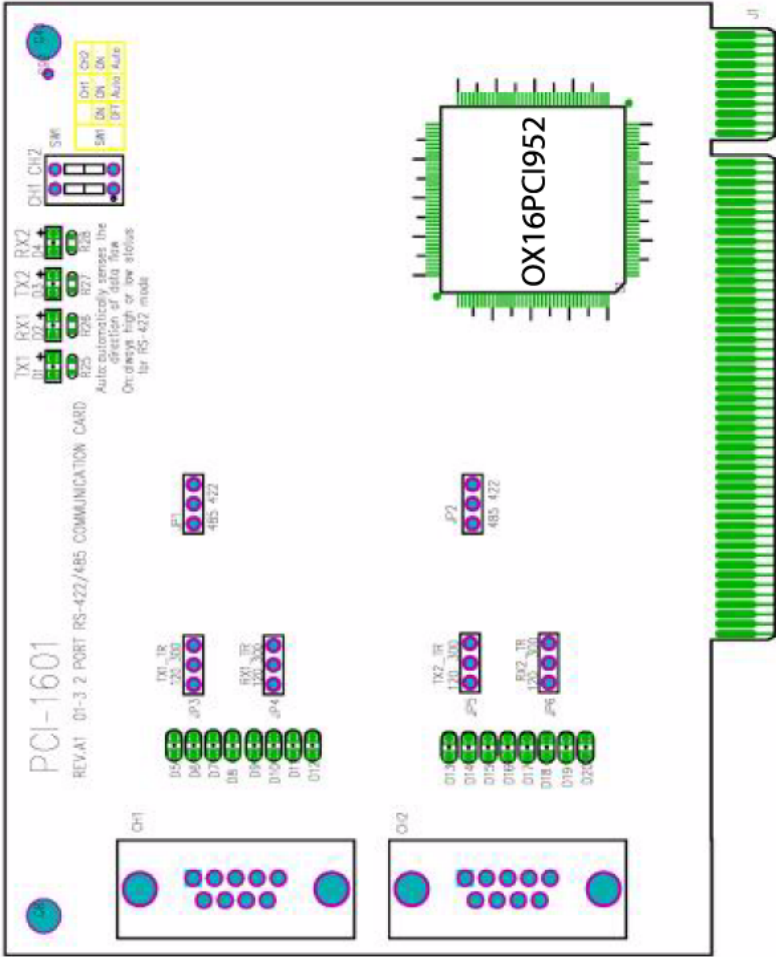

Figure 2.1: PCI-1601A/B Silk Screen

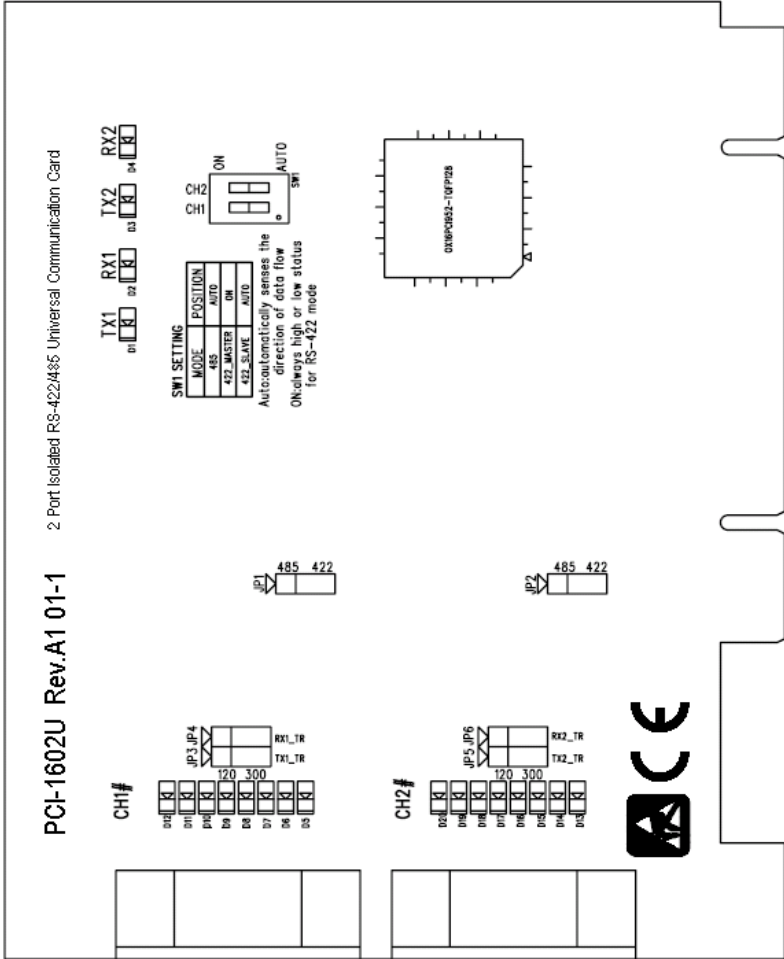

Figure 2.4: PCI-1602AU/BU Silk Screen

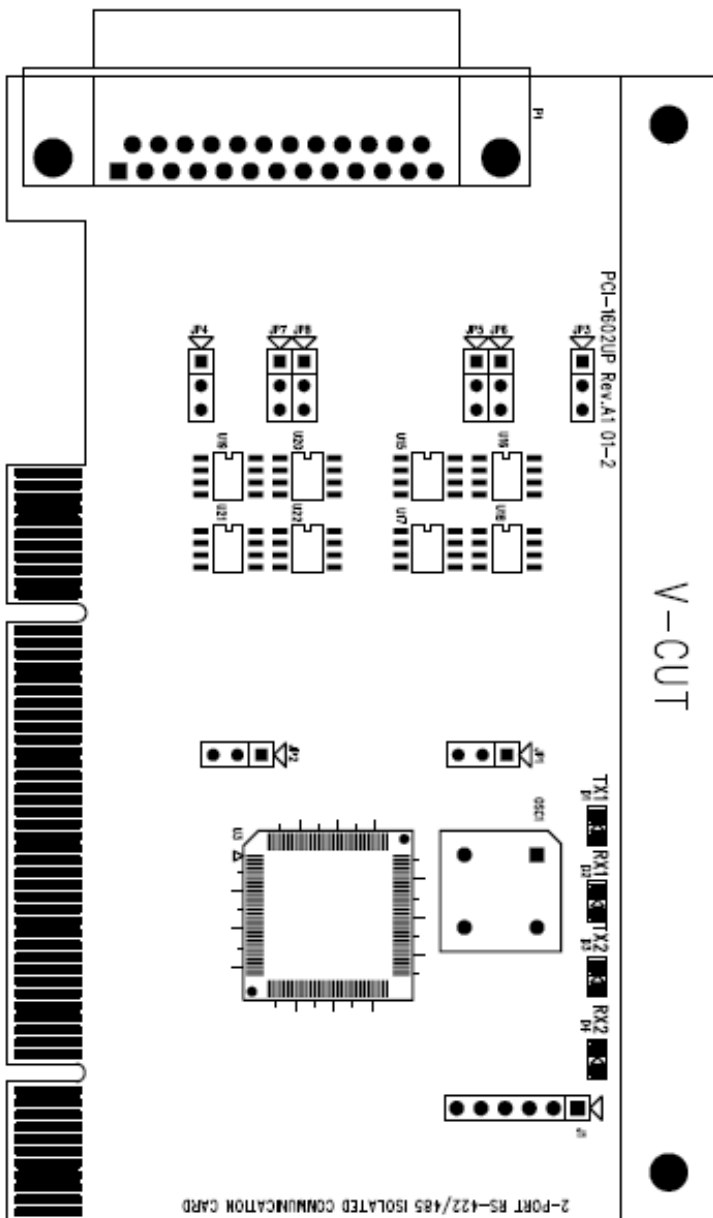

Figure 2.5: PCI-1602UP Silk Screen

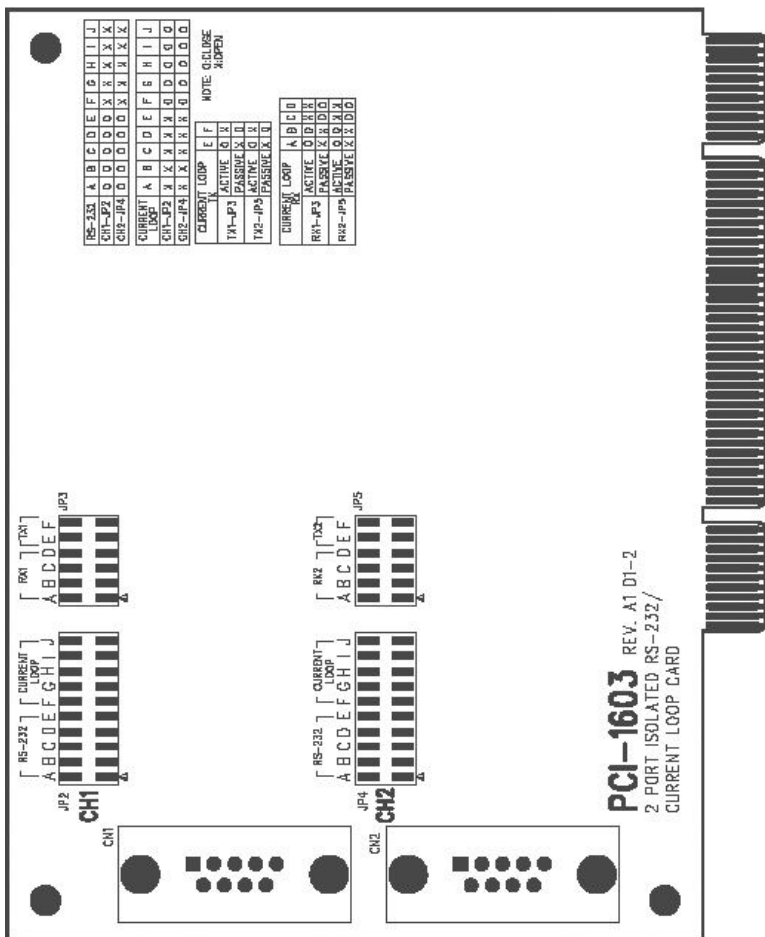

Figure 2.6: PCI-1603 Silk Screen

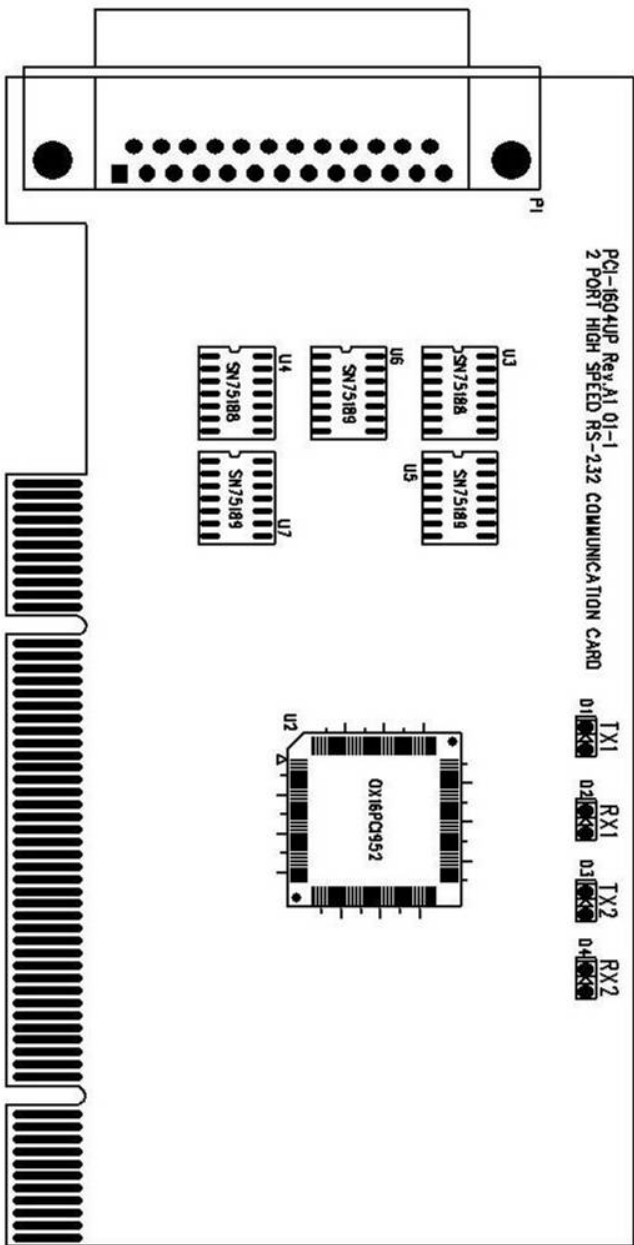

Figure 2.7: PCI-1604UP Silk Screen

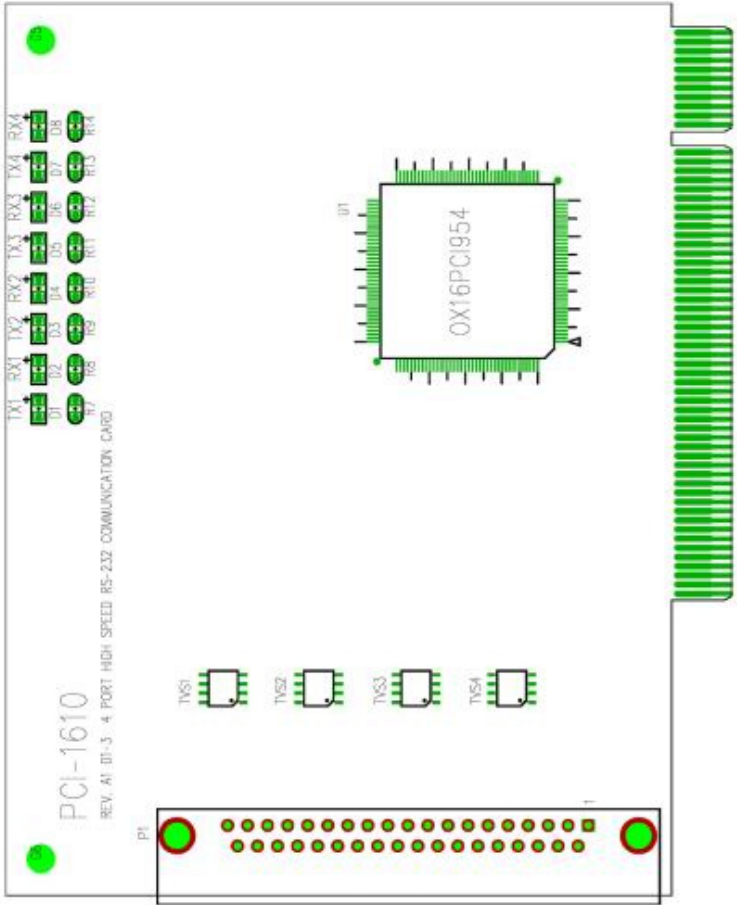

Figure 2.8: PCI-1610A/B Silk Screen

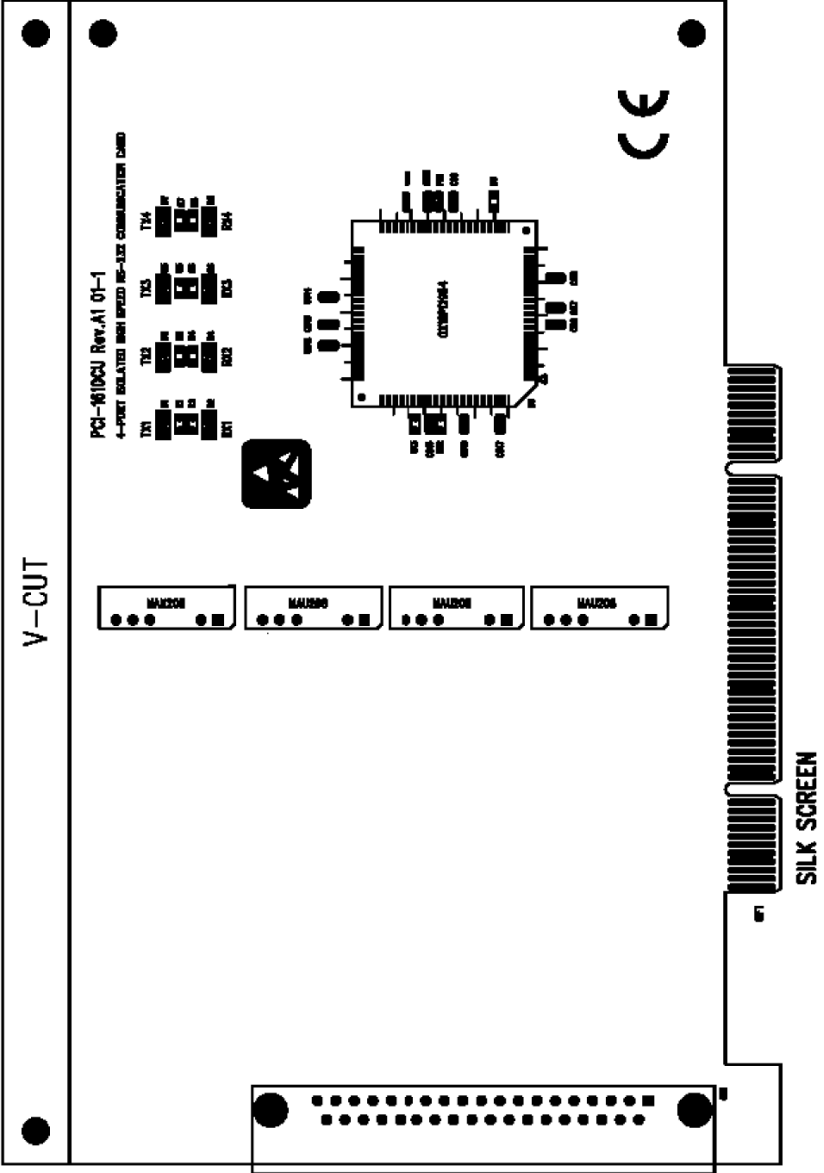

Figure 2.9: PCI-1610CU Silk Screen

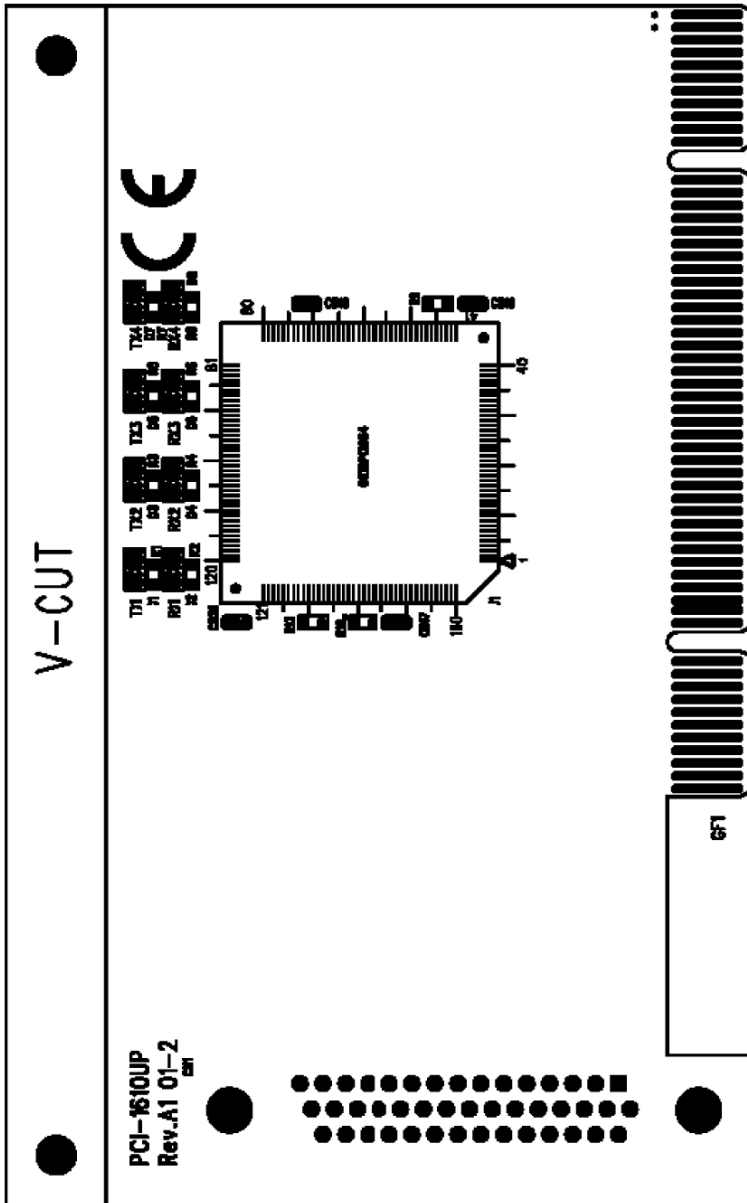

Figure 2.10: PCI-1610AUP/UP Silk Screen

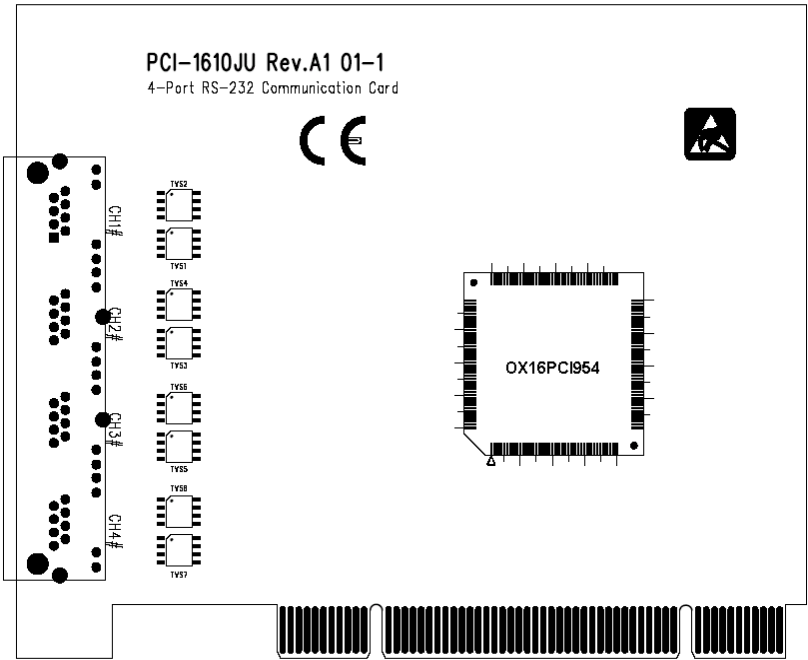

Figure 2.11: PCI-1610AJP Silk Screen

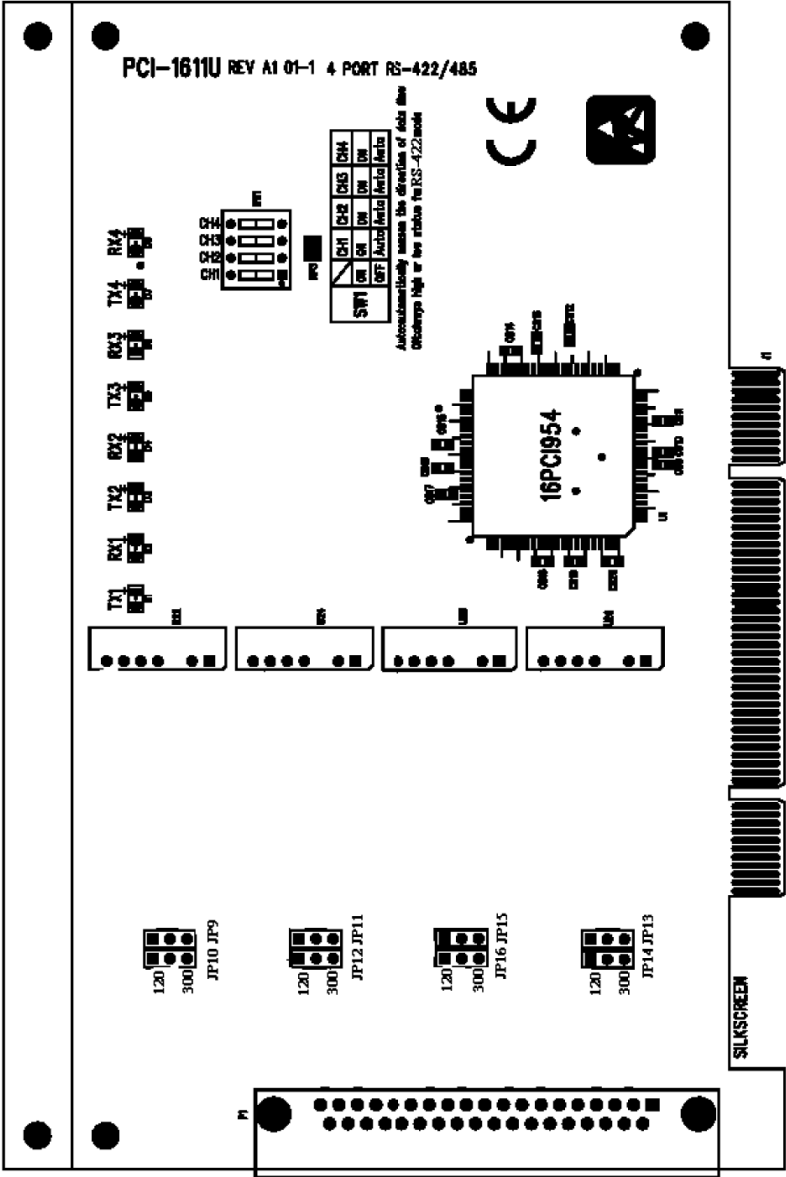

Figure 2.12: PCI-1611U Silk Screen

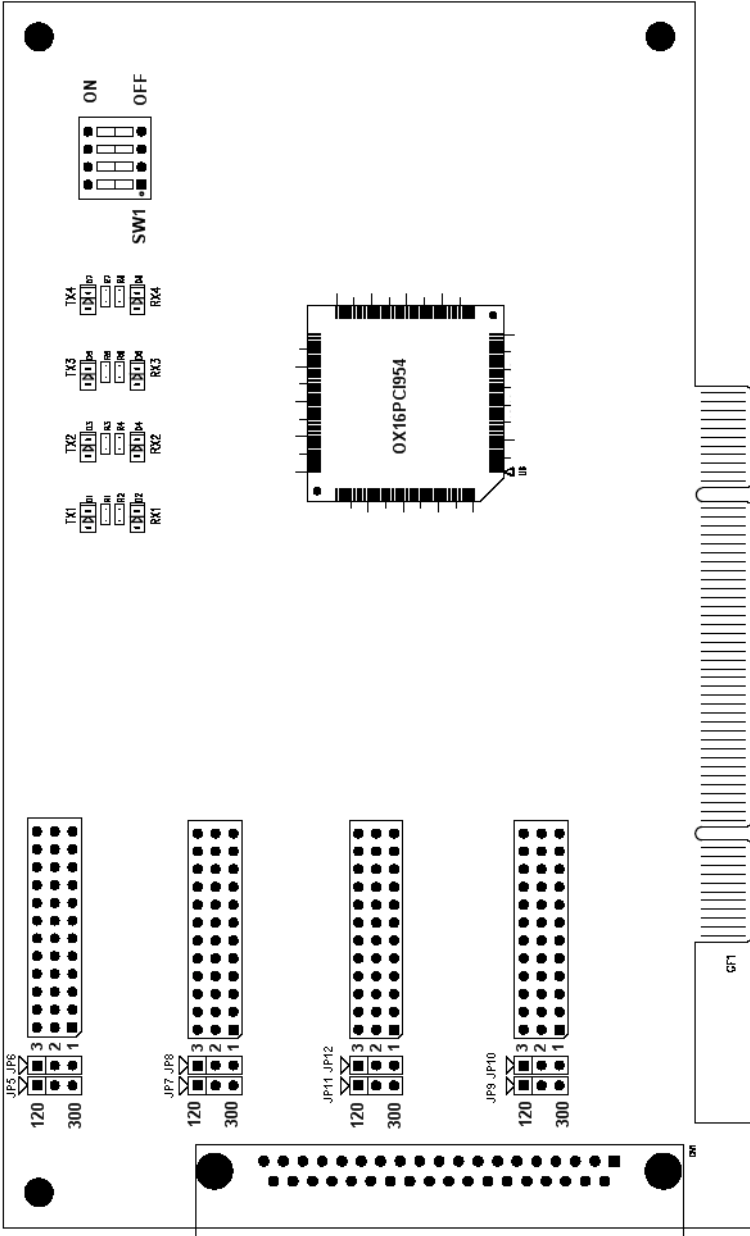

Figure 2.15: PCI-1612CU Silk Screen

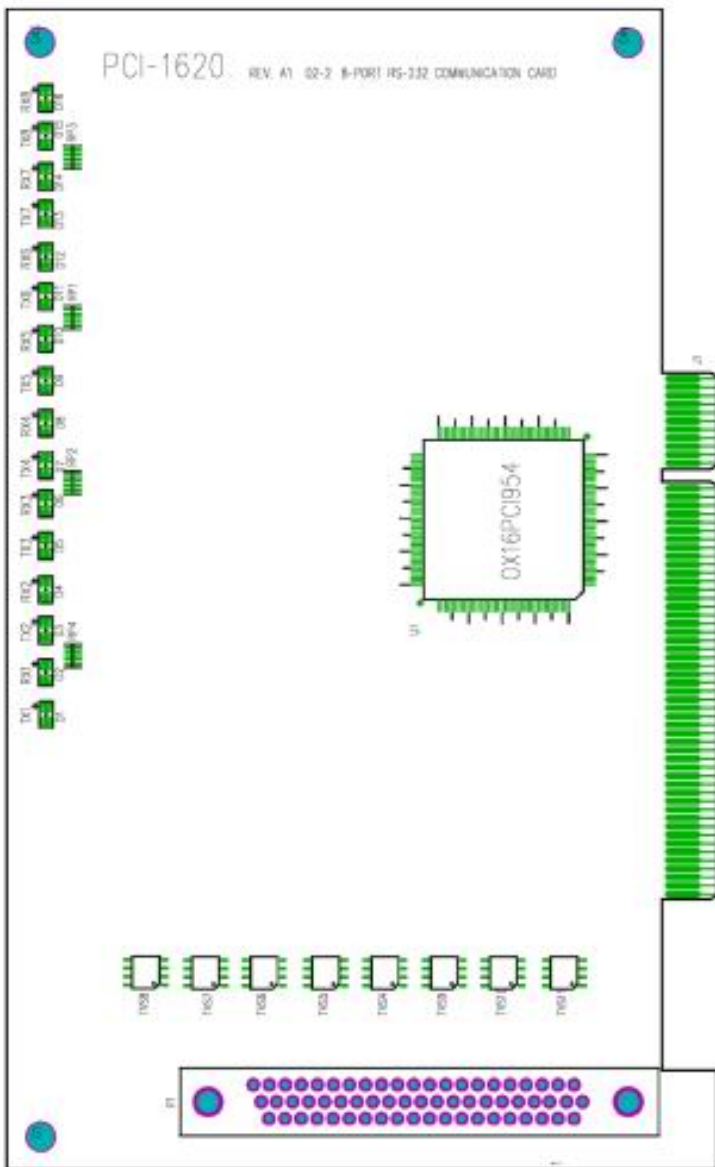

Figure 2.16: PCI-1620A/B Silk Screen

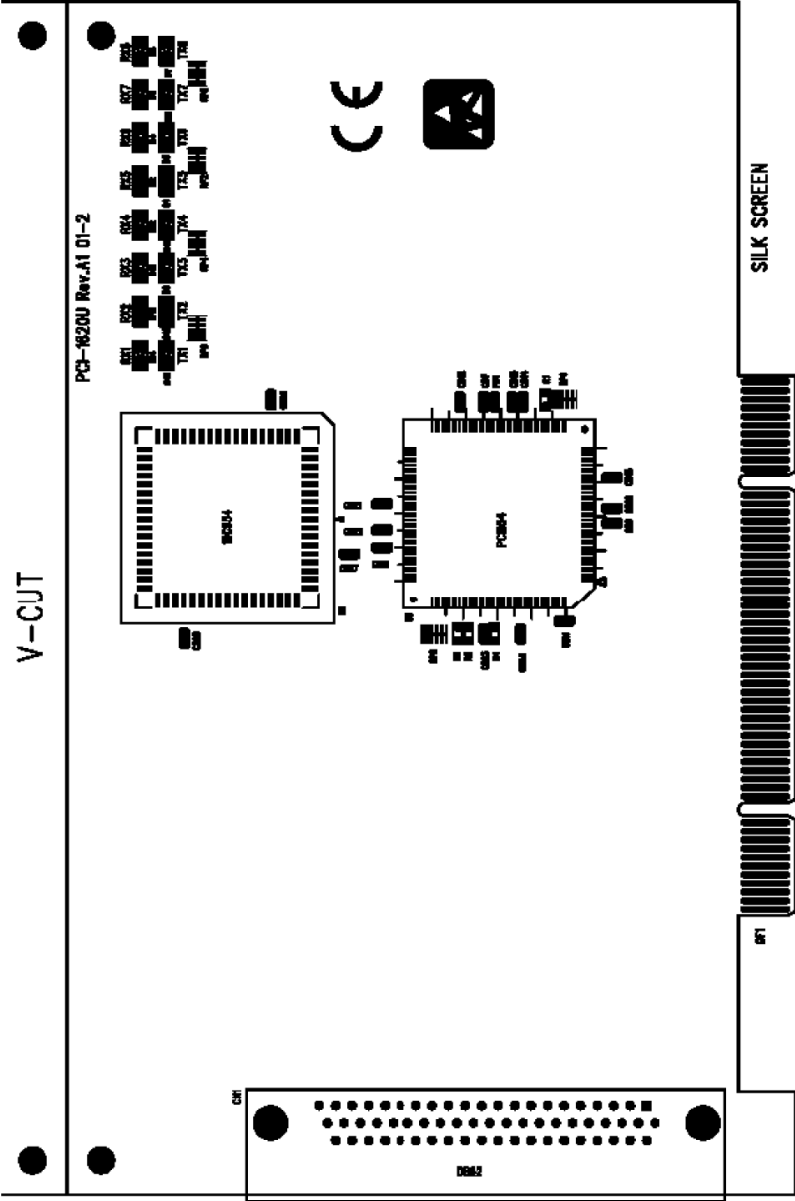

Figure 2.17: PCI-1620AU/U Silk Screen

2.3 Jumper Settings

This section tells how to set the jumpers to configure your card. It gives the card default configuration and your options for each jumper.

2.3.1 How to Set Jumpers

You configure your card to match the needs of your application by setting jumpers. A jumper is the simplest kind of electric switch. It consists of two metal pins and a small metal clip (often protected by a plastic cover) that slides over the pins to connect them. To “close” a jumper you connect the pins with the clip. To “open” a jumper you remove the clip.

Sometimes a jumper will have three pins, labeled 1, 2 and 3. In this case you would connect either pins 1 and 2 or 2 and 3.

You may find a pair of needle-nose pliers useful for setting the jumpers.

If you have any doubts about the best hardware configuration for your application, contact your local distributor or sales representative before you make any changes.

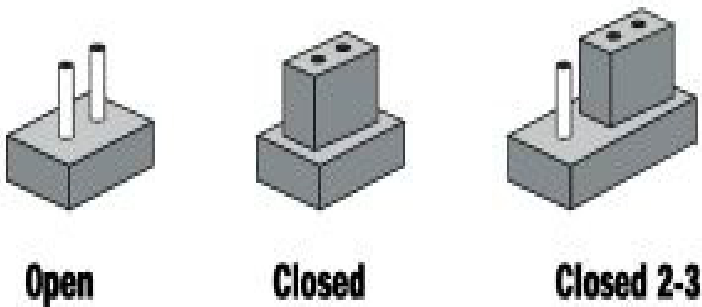

Figure 2.19: How to Set Jumpers

2.3.2 Default Settings

The board is shipped with default settings. If you need to change these settings, however, see the following sections. Otherwise, you can simply install the card.

PCI-1601/1602/1611/1612/1622.

Table 2.1: PCI-1601/1602/1611/1612/1622 Default Setting

RS-422/485 Mode	RS-422
Enable Mode	Auto

PCI-1603

The board will be shipped in the RS-232 mode, passive Rx and active Tx. On the 10*2 pin jumper groups (JP2 & JP4)— A, B, C, D and E are set to RS-232 transmission mode. On the 6*2 pin jumper groups (JP3 & JP5)— C, D and E are set to passive Rx and active Tx. They are the card default settings.

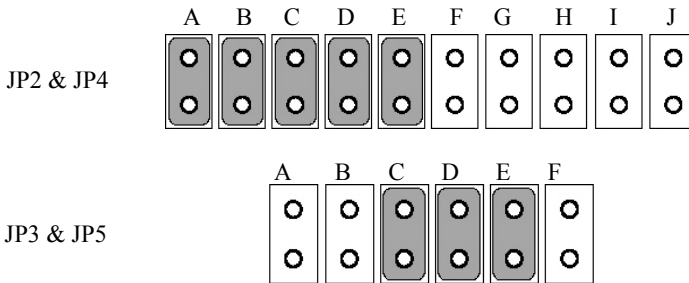

Figure 2.20: PCI-1603 Default Setting

2.3.3 Mode Selection by Jumper/DIP Settings

RS-232/422/485 Selection (for PCI-1612A/B/AU/U/CU)

Should you wish to configure the PCI-1612A/B/AU/U/CU to operate in the RS-232 mode, the bottom two pins of the 12*3 pin jumper should be connected. For RS-422/ RS-485 mode selection, the upper two pins of the 12*3 pin jumper should be connected as shown below.

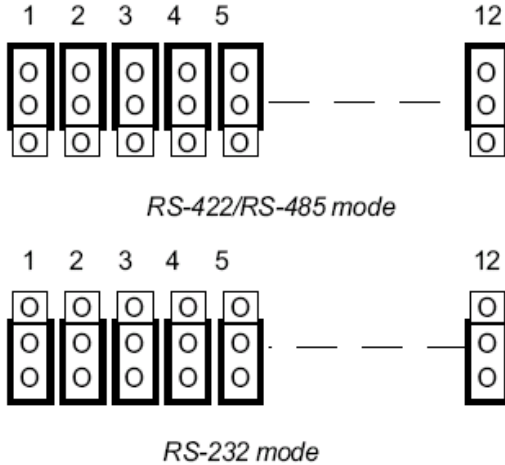

Figure 2.21: PCI-1612 Series RS-232/422/485 Selection

RS-422/485 Selection (for PCI-1601/1602/1611/1612/1622)

You can set each port individually for either RS-422 (the default) or RS-485 operation. The figure 2.11 shows the jumper setting. See section 2.2 "Jumper and Switch Locations" from figure 2.1 to figure 2.17 for help to locate the jumpers. (Except PCI-1612CU/PCI-1611U)



Figure 2.22: RS-422/485 Selection by Jumper Setting

PCI-1603 RS-232/Current-loop Mode Selection

For RS-232 mode operations, the jumpers will be set as the default mode. The jumpers on the 10*2 pin jumper must be set to A, B, C, D and E.

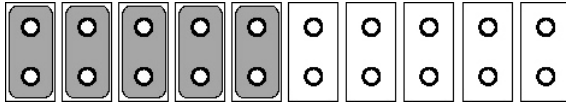

Figure 2.23: PCI-1603 RS-232 Mode Jumper Setting

To enable the channel to operate in the current-loop mode, you should set F, G, H, I and J on the 10*2 pin jumpers.

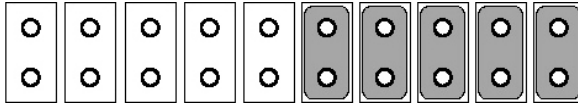

Figure 2.24: PCI-1603 Current-loop Mode Jumper Setting

Then decide which mode the Tx and Rx will operate in. The options are active or passive. In the active mode, the Tx or Rx will generate the current requirement for data transfer over the link. In the passive mode, the current is generated by the card at the other end of the link.

A and B are set to be active Rx, and E is set to be active Tx.

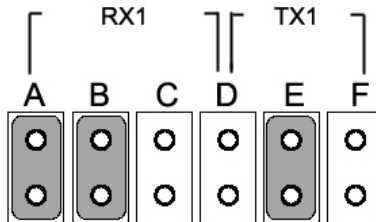

Figure 2.25: Active Mode Jumper Setting

C and D are set to be passive Rx, and F is set to be passive Tx.

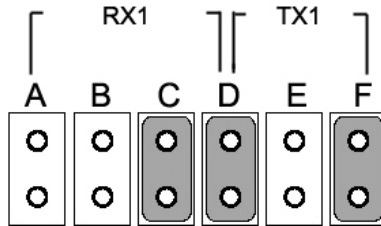

Figure 2.26: Passive Mode Jumper Setting

You may configure both Tx and Rx on one port to operate in the same mode, or you can configure each Tx and Rx on one port to operate in different modes.

If you set PCI-1603 to the current-loop mode, plug the card to your device and turn on the device, both LEDs Rx1 and Rx2 on top corner of PCI-1603 board are lighten, indicating that current-loop mode is enabled!

Note: *When either channel is configured in the RS-232 mode, the two associated Tx/Rx active/passive jumpers will be inoperable.*

Enable mode selection

You set the Enable mode using two, four or eight position DIP switches, one for each port. If the switches are set to "AUTO", the driver automatically senses the direction of the data flow and switches the direction of transmission. No handshaking is necessary.

If DIP switches are set to "On," the driver is always enabled, and always in high or low status. The user must select a mode before beginning RS-422 applications.

Mode	Switch Position
RS-485	AUTO
RS-422_master	ON
RS-422_slave	AUTO

Terminator resistor setup (for PCI-1601/1602/1611/1612/1622)

You can install terminator resistors if necessary to match impedance. Each signal line (Tx, Rx) has a separate resistor.

Especially in fields with serious electric noise, installing terminal resistors is helpful to stabilize communications. Make sure that both sides of the RS-485 communication ports are installed on BUS. See details in Chapter 5.2.2 and 5.2.3

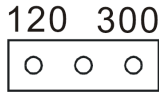

Figure 2.27: Resistor Selection

2.4 Card Installation

Note: We strongly recommend that you install the software driver before you install the hardware into your system, since this will guarantee a smooth and trouble-free installation process.

Turn off your PC's power supply whenever you install or remove the PCI communication card or its cables. Static electricity can easily damage computer equipment. Ground yourself by touching the chassis of the computer (metal) before you touch any boards. See the static warning on Ch.2

1. Install the driver; see chapter 3.1 and chapter 3.2.
2. Turn off the computer and all peripheral devices (such as printers and monitors).
3. Disconnect the power cord and any other cables from the back of the computer.
4. Remove the PC's cover (refer to your user's guide if necessary).
5. Install and plug the PCI communication card on your PCI BUS.
6. Replace the PC's cover. Connect the cables you removed in step 3.
7. Turn the computer power on.
8. Driver will install PCI Communication card automatically, see chapter 3.3 and 3.4 and 3.5.
9. Test your COM port and verify if COM port could work normally, see chapter 4.
10. Refer to the pin assignment and cabling for further information, see chapter 5.

Driver Setup and Installation

This chapter describes the driver installation, configuration and removal procedures for the Windows operating system, including Windows 98/2000/XP.

Sections include:

- Introduction
- Driver Setup

Chapter 3 Driver Setup & Installation

3.1 Introduction

This chapter describes the driver installation, configuration and removal procedures for the Windows operating system, including Windows 98/NT/2000/XP. **We strongly recommend that you install the software driver before you install the hardware into your system, since this will guarantee a smooth and trouble-free installation process.**

3.2 Driver Setup

Windows 98/2000/XP supports **COM1** to **COM256**, meaning up to **256** serial ports. In order to fully utilize the advanced features of Windows 98/2000/XP, such as multi-process and multithread, pure 32-bit Windows 98/2000/XP device drivers are provided for the PCI communication cards. All these drivers conform to the Win32 COMM API standard.

3.2.1 Steps for Windows 98/2000/XP Driver Setup

Before you install the card into your system, we recommend you install the driver first. Please follow the steps below for the PCI communication card's Windows 98/2000/XP driver installation.

1. Insert your companion CD-ROM disc into your CD-ROM drive.
2. The driver setup program will be launched automatically. If the auto-play function is not enabled on your system, use Windows Explorer or the Windows Run command to execute **autorun.exe** on the companion CD-ROM.

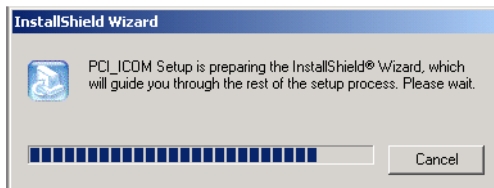

3. After the setup program is launched, you'll see the following *Screen*.



4. Click the *Continue* button and the catalogue *select* page appears. Then click the Installation button for installation

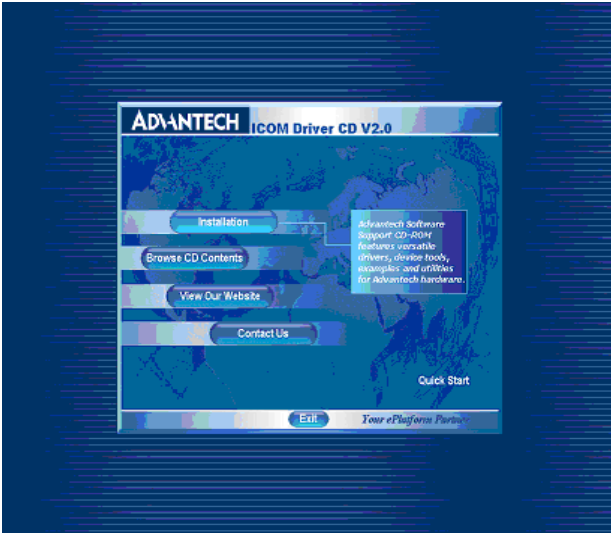

5. Choose the driver you want to install, then click the hyperlink.



6. Click *Next* to continue installation.

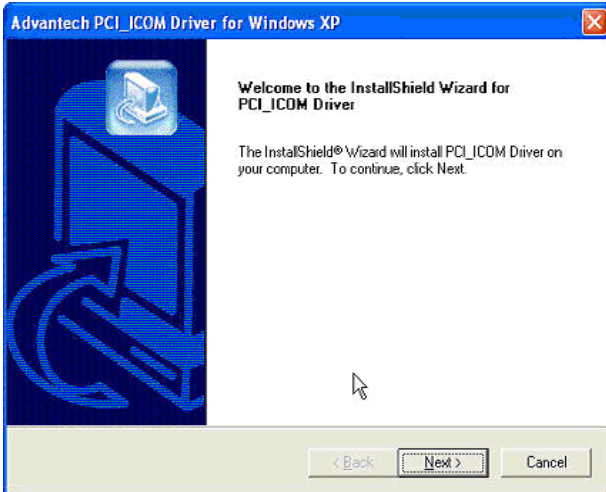

7. Type user name and company name, then click *Next*.

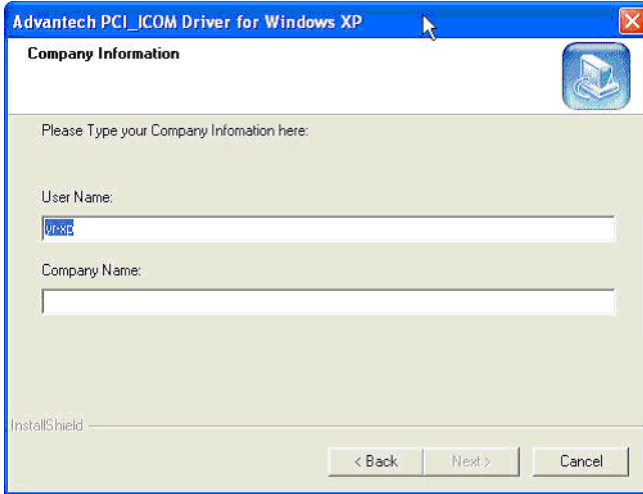

8. Just click *Next* to accept the default installation folder, or you can specify a folder by clicking the *Browse* button.

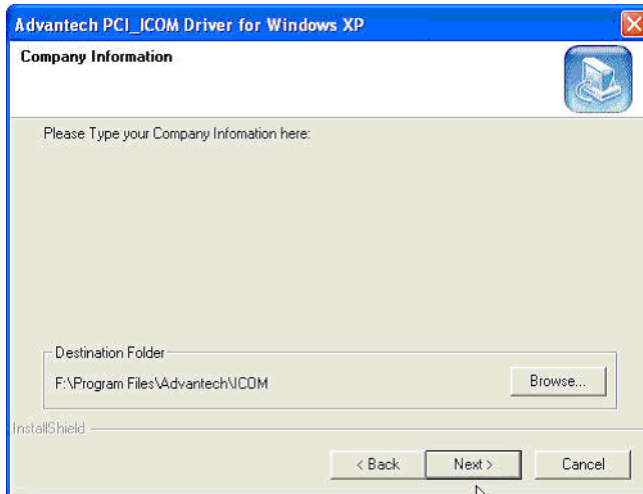

9. Select a program folder or type a new folder name.

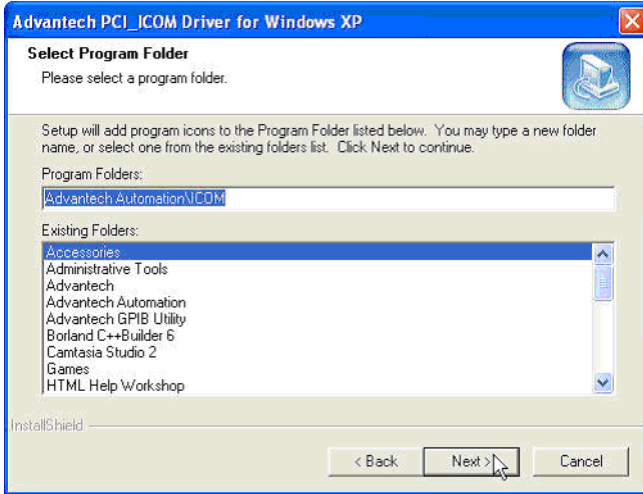

10. Click **Back** to review or change your setting, or click **Next** to begin copying files.

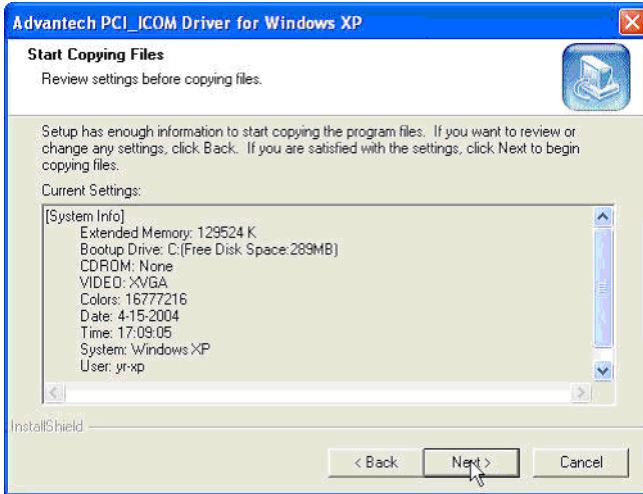

11. Perform the requested operations and select Finish.

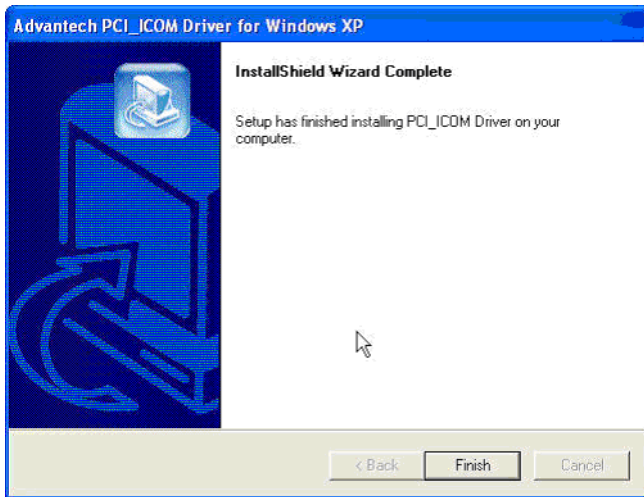
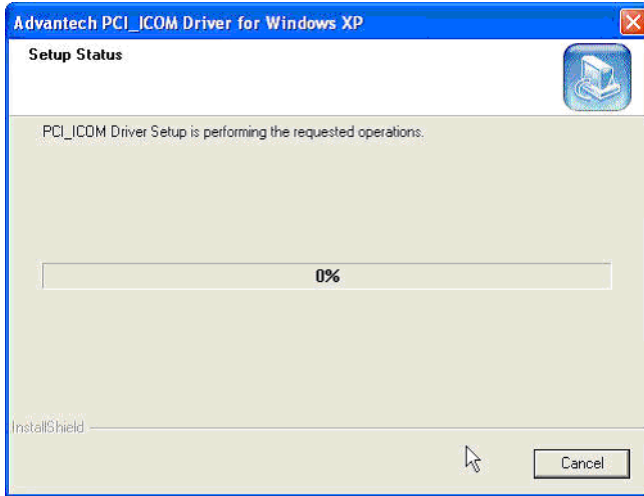

3.3 Reboot System after Win98/2000/XP Driver Setup

3.3.1 PCI UARTs Device Driver Installation

1. When you reboot your system, Windows 98/2000/XP will recognize your card devices and will automatically search for the device driver for PCI UARTs as shown in the following dialog box.



2. Choose “*Search for the best driver for your device*” radio button, and click **Next**.



3. You don't have to choose the location of the device driver program, since it is already installed on your system. Just click *Next* to proceed.



4. Windows 98/2000/XP has found the driver location and is ready to install the driver. Click *Next*.



5. The driver installation is complete. Click ***Finish***.

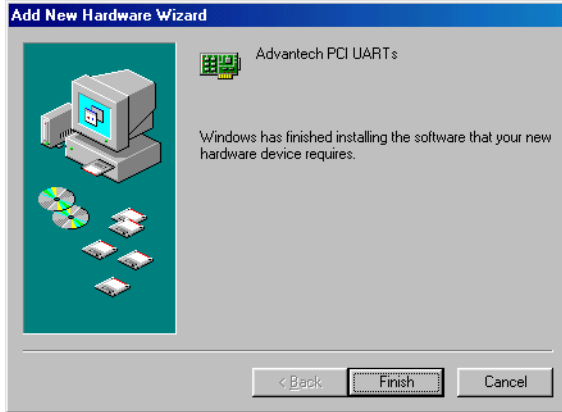

3.3.2 PCI Bridge Device Driver Installation

After the PCI UARTs device driver has been installed, Windows 98/2000/XP will recognize the PCI Bridge device and automatically install the device driver for PCI Bridge.

3.4 Verify your Win98/2000/XP Driver Setup

After you have installed your card, go to Control Panel/System/Device Manager to look for the Device Name that will appear after you have installed the driver.

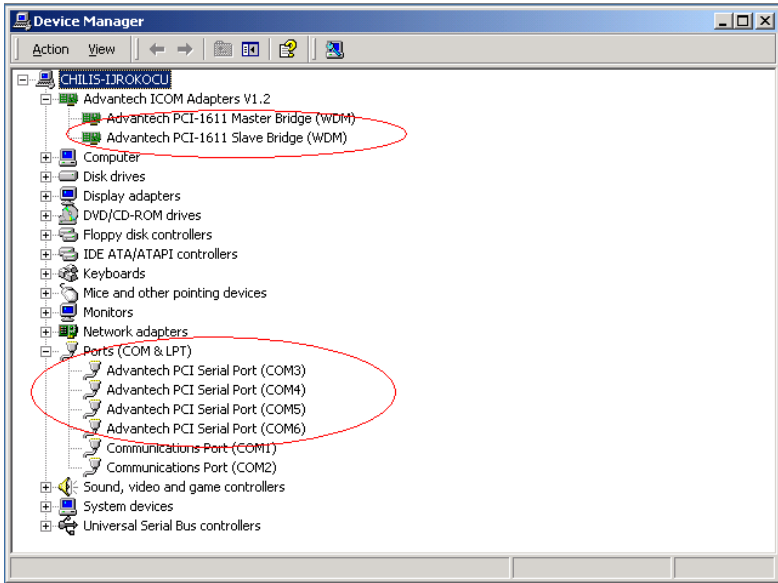

Note: *If your device has not been properly installed, there will be an exclamation mark (!) on the device name to indicate a conflicting device. If this is the case, just remove that device and start the driver installation process all over again.*

You can also check the COM Port properties by double-clicking the specific com port device configuration you want to see. On the **Properties** sheet, select the specific tabs to see relevant information.

On the **General** tab, you can see whether the device is working properly. If your device functions normally, you can see a message under the **Device** status box, stating “This device is working properly”.

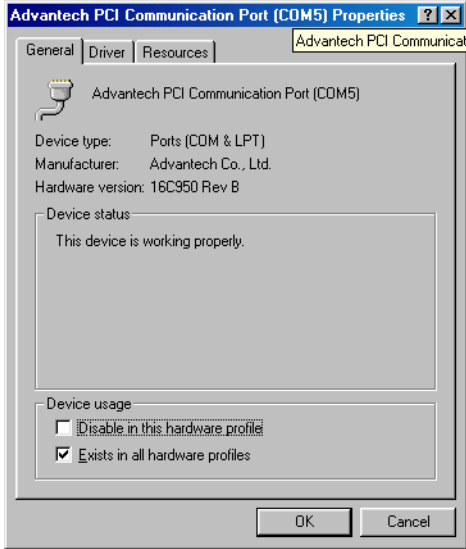

On the **Settings** tab, you can view relevant information about that specific port, as you can see on the figures below.

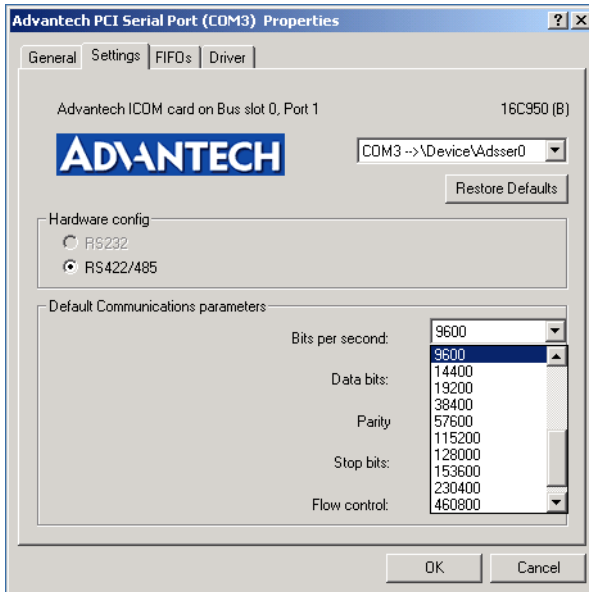
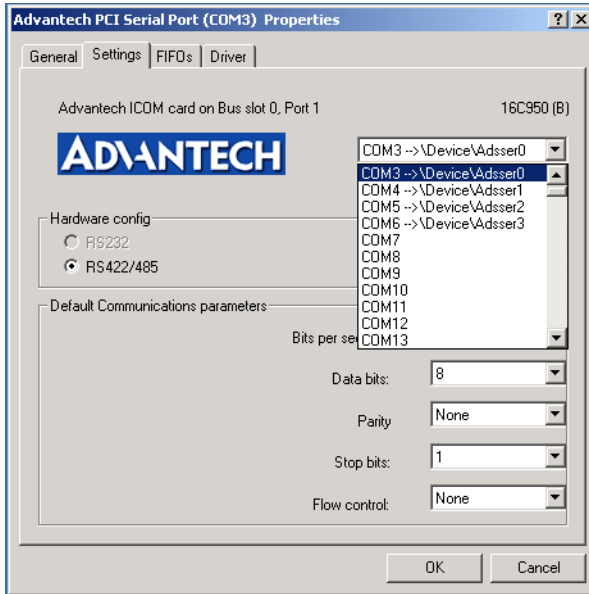

If you want to configure FIFO Properties, select the FIFOs tab. On the tab, you can see the relevant FIFO configurations. We recommend you use the default settings. However, you can set the configurations manually according to your preferences. If you want to restore the default settings, just click the **Restore Default** button.

3.5 Configuring Serial Devices for Win 98/2000/XP

After your serial devices have been properly installed in your system, you can now proceed to configure your serial devices according to the following steps:

1. Access Control Panel/System

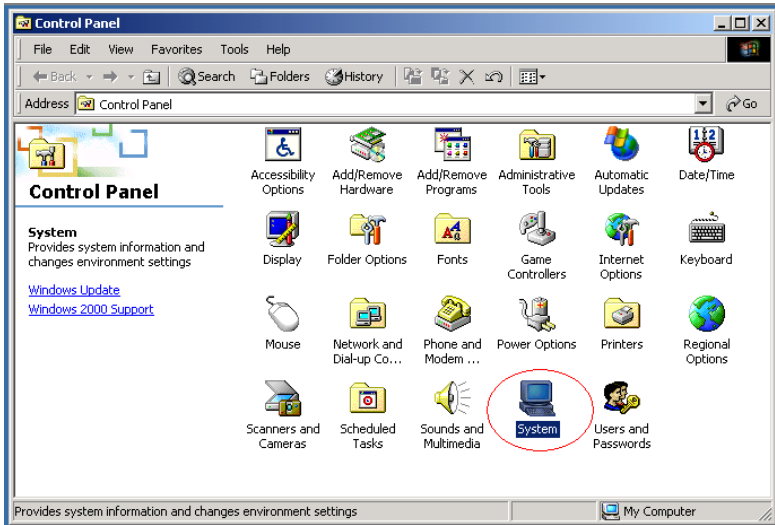

2. Select **Device Manager** tab on the **System Properties** sheet.

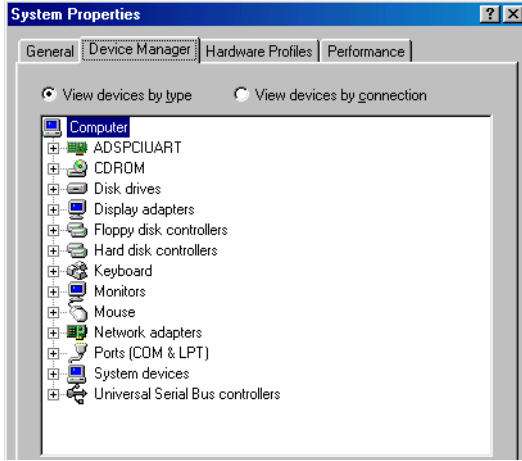

3. Click the plus sign (+) on the right of the **ADSPCIUART** device category to expand it. As shown on the figure below, you can see **Advantech PCI UARTs** and **Advantech PCI Bridge** device names listed under the device category.

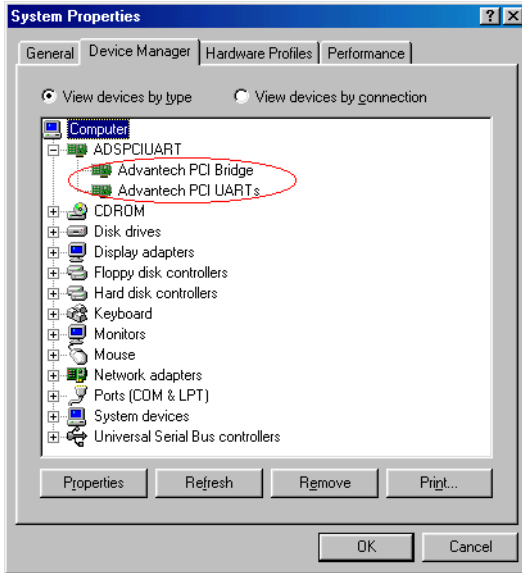

3.5.1 Configuring a PCI UARTs Device

1. Double-click the *Advantech PCI UARTs* device to evoke its *Properties* page, and then select the *Resource* tab on the *Properties* page to look up or configure the current settings of the *PCI UARTs* device.

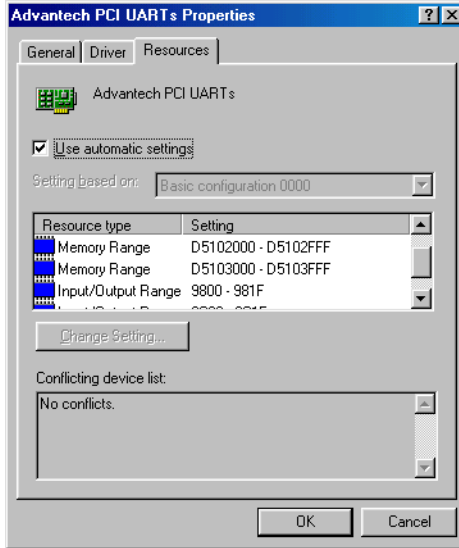

2. After you have made the necessary changes or if you are just satisfied with the default settings, click **OK** to accept. If you want to cancel the configuration, click **Cancel**.

3.5.2 Configuring a PCI Bridge Device

Double-click the Advantech PCI Bridge device to evoke its Properties page, and then select the Resources tab on the Properties page to look up or configure the current configuration of the PCI Bridge device to make sure there are no conflicting devices. Click other tabs to look up or configure the device.

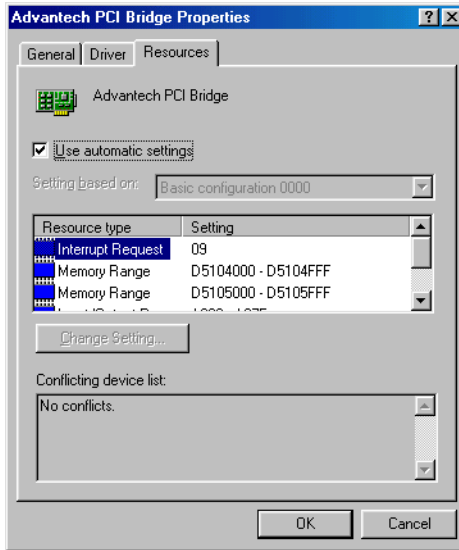

Note: The Input/Output Range information is helpful to recognize the communication port attached to the device.

After you have made necessary changes or if you are satisfied with the default settings, click **OK** to accept. If you want to cancel the configuration, just click **Cancel**.

3.5.3 Configuring Ports

The ports will be configured automatically, so you don't need to do anything.

3.6 Remove PCI ICOM Series Device

1. Access Control Panel/System to bring up the System Properties window.

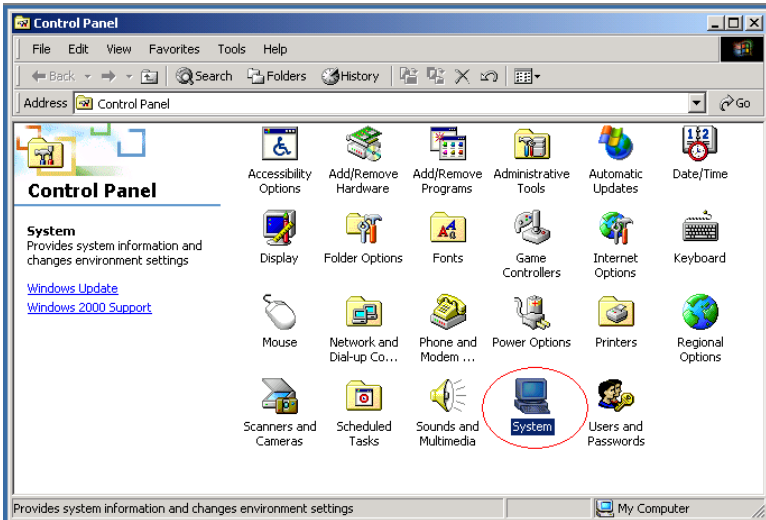

2. Select the Device Manager tab.

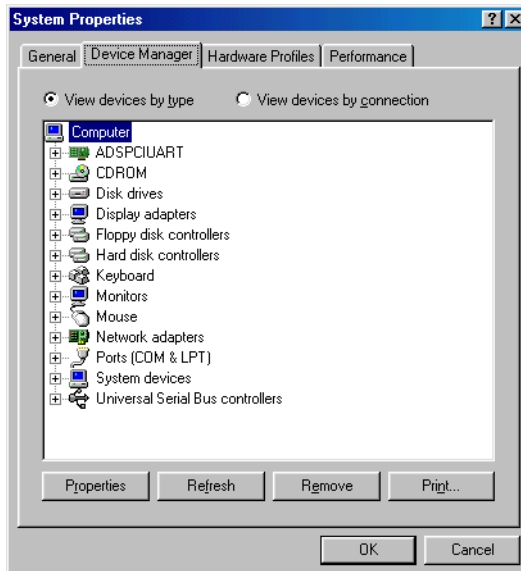

3. Click the plus sign (+) on the left of the **Ports (COM & LPT)** device category to expand it. Select the specific “Advantech PCI communication port” you want to remove, and click the **Remove** button to remove the device you had selected.

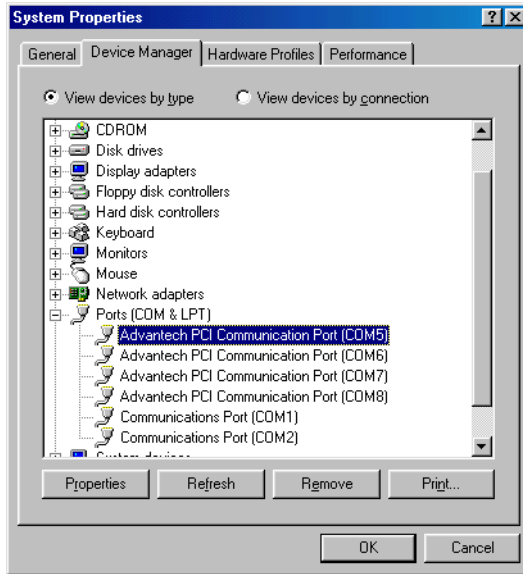

4. The following dialog box will appear to prompt you again to make sure you really want to remove the device from your system.

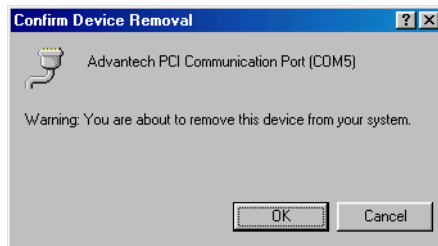

- Click the plus sign (+) on the left of the **ADSPCIUART** device category to expand it, and select the *Advantech PCI UARTs* or *Advantech PCI Bridge* you want to remove.

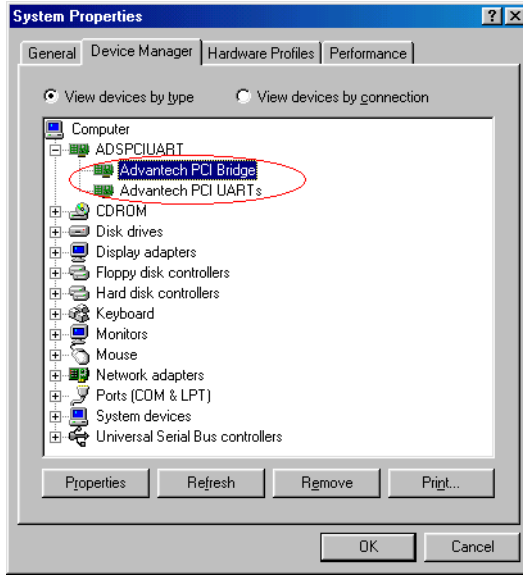

Note: You must remove all used ports settings and device settings before you remove the device, or there may be a mistake in the port setting when you install another card.

- Click the **Remove** button and the following dialog boxes appear to prompt you whether you really want to remove the device.

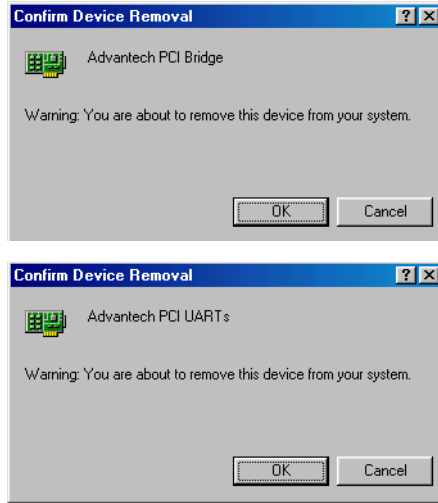

Note: We recommend you to remove the original device before installing another model of Advantech PCI ICOM series device in the same PCI slot.

3.7 Driver Uninstall

- Insert the ICOM CD and click the driver you want to uninstall.

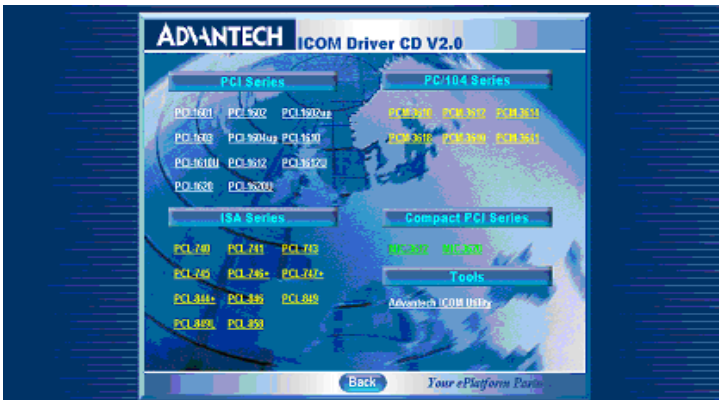

2. Choose “Modify” radio button if you want to save another driver. Or choose “Remove” radio button to remove all installed components.

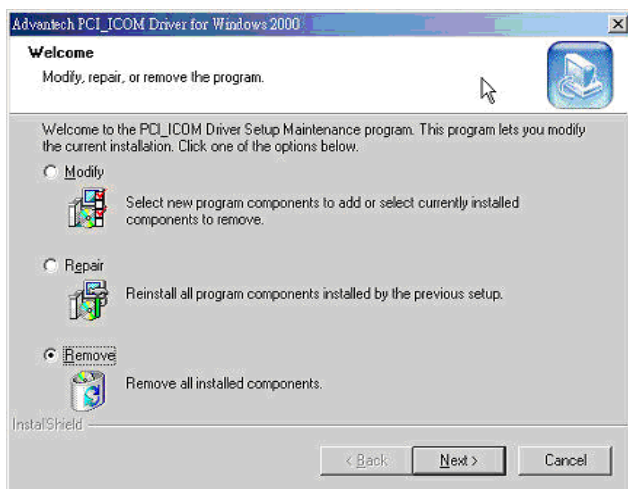

3. Click “Finish” button to complete the uninstall.

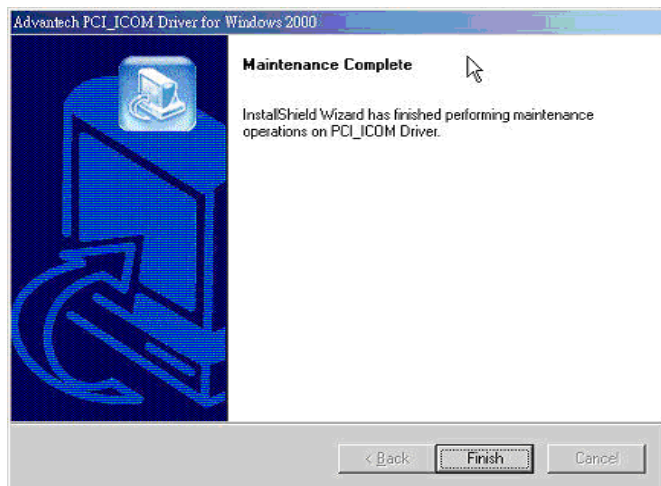

ICOM Tools

This chapter provides information on installation and usage of ICOM Tools.

Sections include:

- Introduction
- Installation
- User Interface of ICOM Tools

Chapter 4 ICOM Tools

4.1 Introduction

Advantech ICOM Tools is a convenient utility that has been designed to help you test the performance of ICOM cards through analyzing the port status. It features an easy to use graphical user interface that will soon make you familiar with testing via menu commands and toolbar buttons.

Advantech ICOM Tools is applicable to all series of Advantech ICOM cards, and can even be used with other third-party ICOM cards. It is included for free on the diskette or on the companion CD-ROM with all Advantech Industrial Communication cards.

4.2 Installation

To begin installation, double-click the ICOM_Tools.exe program icon in the Tools folder or click the Advantech ICOM Utility hyperlink in the installation window to launch the **ICOM Tools** setup program. The setup program will copy the program files to the destination folder you choose or to the default installation path (i.e. C:\Program Files\Advantech\ICOM Tools). A program folder will be created in your Start/Programs menu. (Later you can just access the program through *Start/Program/Advantech PCI Comm Tools/COM Examine Tool*)

4.3 User Interface of ICOM Tools

4.3.1 Menu Bar



Port All Ports Help

On the Menu Bar you can select various menu commands to perform port-testing functions. You can also use the short-cut keys.

Port Submenu

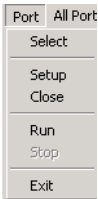

Select: Select the ports you want to configure

Setup: Setup the configuration of a specific port

Close: Close a specific port

Run: Run the test on a specific port

Stop: Stop the test on a specific port

All Ports Submenu



Setup: Setup the configurations of all ports

Run: Run the test on all ports

Stop: Stop the test on all ports

Help Submenu Access Online help

4.3.2 Tool Bar



Using the **Tool Bar** buttons is a more intuitive way to implement the functions of **ICOM Tools**.



Port Select: Selects the port(s) you want to perform testing on



Port Setup: Sets up configuration of the port you have selected



Port Close: Closes the port you have selected



Port Run: Runs the port test on the port you have selected



Port Stop: Stops the port test on the port you have selected



All Ports Setup: Sets up the configuration of all ports not running test



All Ports Run: Runs test on all ports



All Ports Stop: Stops test on all ports



Clear Message: Clears messages on Message Logo area and the Rx length information on the Performance Listing area

4.3.3 Com Port Tab

Each Com Port tab represents a specific port you have selected for test and configuration. On the tab, you can see the Transfer Mode, Port Status, and Message Logo area.

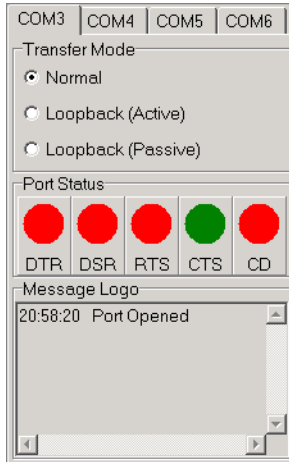

Transfer Modes

You can specify the transfer mode to be Normal, loopback (active) or loopback (passive).

Normal—allows data to be transmitted and received simultaneously. The data reception rate is helpful in identifying the performance of a communication card installed on your system.

Loopback- In loopback mode a series of special data will be transmitted, which are expected to appear on the receiving end. Using the loopback mode, you can check the integrity of received data and find whether any error occurred on the transmission line. The active loopback and passive loopback must work in pair to enable the loopback mode. When a port operates as active loopback mode, it will send data first and receive data later. Another port, which operates as passive loopback, will retransmit any received data on the Rx line and then send these data onto the Tx line. These two modes will form a logical loop and help to verify the integrity of data transmitted over the communication link.

4.3.4 Port Status

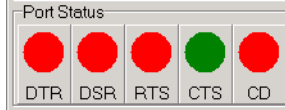

DTR (data-terminal-ready)

DSR (data-set-ready)

RTS (request-to-send)

CTS (clear-to-send)

CD (carrier-detect)

For RS-232 specifications, DTR and RTS are for output signals and can be toggled on and off by double-clicking the labels (such as DTR, DSR, RTS, CTS, CD) under the red/green marks. However, if you are using RTS/CTS for flow control to run the test, you will see the RTS mark appear in black. This indicates that the RTS can no longer be toggled on/off since it is controlled by driver itself.



A black mark represents that the function is controlled by the driver itself and therefore not controllable by software.

4.3.5 Message Logo

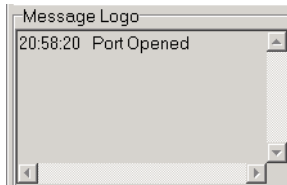

On the *Message Logo* area, you can see the relevant messages about the port(s) you have selected.

For information about specific messages in this area, please refer to Section 4.5, Messages on the Status Bar and Message Logo area.

4.3.6 Tx Slide Bar

The **Tx Slide Bar** allows you to control the overall system loading. You can adjust the transmission rate of your port(s) from 0% to 100%. Just drag the slide button along the track to adjust the transmission rate.



4.3.7 Performance Listing Area

On the performance listing area, you can see the relevant information, such as Rx Length (received packet byte length), Bytes/Sec (transmission rate) and Last Abnormal Status of each port running a test.

Port	Rx Length	(Bytes/Sec.)	Last Abnormal Status
3	0	0	21:54:56 Port Running
4	0	0	21:55:04 Port Running
5	0	0	21:55:04 Port Running
6	0	0	21:55:04 Port Running

4.3.8 Status Bar



The Status Bar is where you can glimpse the current information of the port you have selected. The Status Bar indicates whether the port is READY, RUNNING, BUSY or STOPPED, N/A PORT and the configuration information such as baud rate, data bit, stop bit, parity bit and flow control (represented as 1200 N 8 1 None) settings. Also we can see the duration of the test in hh:mm:ss format on the right.

For information about specific messages on this area, please refer to Section 4.5, Messages on the Status Bar and Message Logo area.

4.4 Using the ICOM Tools Utility

To launch the ICOM Tools testing utility, access Start/Programs/Advantech PCI Comm Tools/COM Examine Tools to start the port testing utility.

4.4.1 Port Selection

Please follow the steps below to make your port selection:

1. Launch ICOM Tools. You will first see the Program Window such as Figure 4.1. Since you haven't selected any port for testing yet, all you can see now is a blank window area.



Figure 4.1: ICOM Tools program window

2. Select the port(s) you want to test by the Port/Select menu command or by clicking the Port Select button on the Toolbar, and a dialog box such as Fig. 2 will appear.

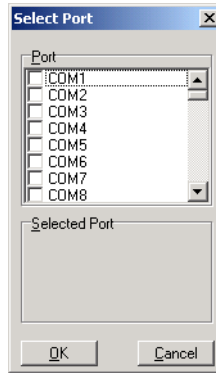

Figure 4.2: Select Port dialog box

Select the port(s) you want to perform test on from the checkboxes next to each COM port. You can either click the checkbox or double-click the name(s) of the port(s) to select/deselect port(s) to perform the test on. The port(s) you selected will immediately appear in the Selected Port field.

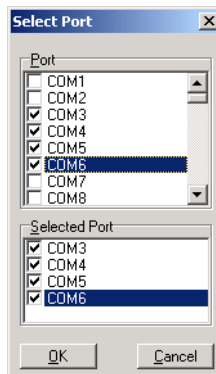

Figure 4.3: Ports You Select Will Appear in the Selected Port Checkbox Group

Click OK to bring up the ICOM Tools User Interface such as below:

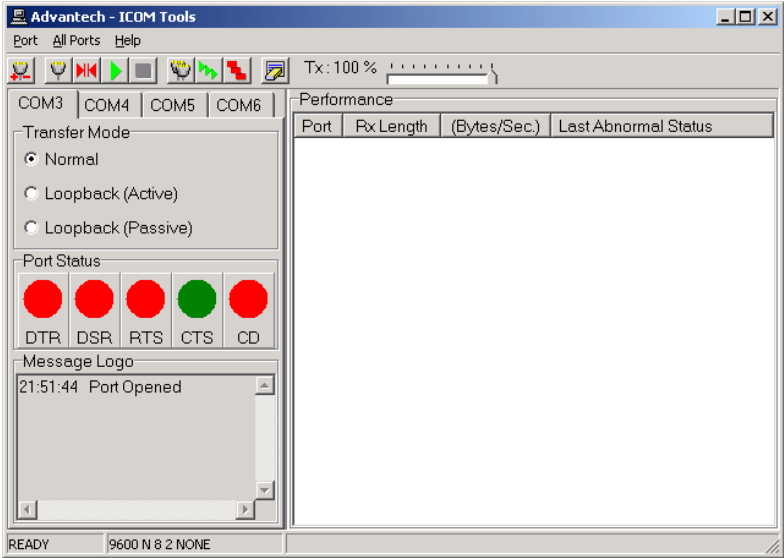

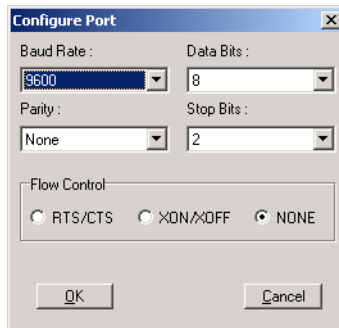



Figure 4.4: ICOM Tools User Interface

4.4.2 Configuring a Port



You can choose to configure a specific port (or to configure all ports) before running your test. Just click a Com Port Tab to select the port you want to configure, and then click the **Port Setup**  button or use the **Port/Setup** menu command (or if you want to configure all ports at once, just click the **All Ports Setup**  button or access the **All Ports/Setup** menu command) to bring up the **Configure Port** dialog box such as below.



In the **Configure Port** dialog box, you can configure the Baud Rate, Data bits, Parity, Stop Bits and the flow control mode for that specific port (or for all ports). After you have configured all the settings you want to change, click OK to make this configuration active.

NOTE: *When using **All Ports Setup** button or **All Ports/Setup**  menu command to configure settings for all ports, you must take care to stop any ports that are running test in order to configure them. If you do not stop the test running on a specific port, it won't be configured at all. That is, you get to configure only the ports that have been stopped.*

Run the Test

After you have completed the configuration of the port(s), you can now start the test on the port you have selected by clicking the **Run**  button or accessing the **Port/Run** menu command (or you want to run all ports at once, just click the **All Ports Run**  button or access **All Ports/Run** menu command).

Once the test is started, you can see relevant test information of port performance on the **performance listing area**.

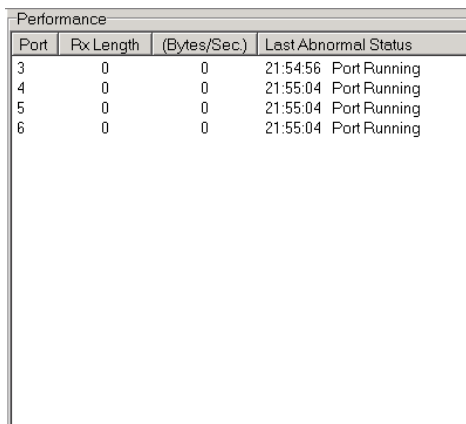

The screenshot shows a window titled "Performance" containing a table with the following data:



Port	Fx Length	(Bytes/Sec.)	Last Abnormal Status
3	0	0	21:54:56 Port Running
4	0	0	21:55:04 Port Running
5	0	0	21:55:04 Port Running
6	0	0	21:55:04 Port Running



Figure 4.5: Test Information on the Performance Listing Area

The Performance Listing Area

<i>Port</i>	The com port number
<i>Rx length</i>	Received packet length in bytes
<i>Bytes/Sec</i>	Transmission rate in Bytes/Sec
<i>Last Abnormal Status</i>	Last abnormal status

Stop the Test

If you want to stop the test on a specific port, just click **Port Stop**  button or access **Port/Stop** menu command (or if you want to stop test on all ports, just click **All Ports Stop**  button or access All Ports/Stop menu command).

You can restart the test by clicking the **Run**  button or accessing the Port/Run menu command (or if you want to run all ports at once, just click the **All Ports Run**  button or access All Ports/Run menu command).

4.4.3 Close Port

If you want to close a port, just select the **Com Port** tab and click **Port Close** button or access **Port/Close** menu command to close the port.

4.4.4 Exit the ICOM Tools utility

To exit the ICOM Tools utility, simply access Port/Exit menu command or click the Close button on the upper right corner of the program window.

4.5 Messages on Status Bar and Message Logo Area

Messages appearing on the Status Bar and Message Logo area are helpful in understanding specific information of your system settings and performance.

4.5.1 Status Bar Messages

BUSY: the port is currently used by another application.

FAIL: the configuration parameters are not accepted by the port

N/A PORT: the port is not available in the system

READY: the port is ready to run or to be configured.

RUNNING: the test is running on the port

STOPPED: the test running on the port has been stopped by the user

4.5.2 Message Logo Messages

Port Opened: The user has opened the port

Port Setup Fail: The user has set up the port configuration with parameters that are either incorrect or unsupported.

Port Running: The port is running a test

Port Stopped: The test is stopped on the port

Tx Starting/Tx Stopped: transmitting starting/transmitting stop

Rx Starting/Rx Stopped : receiving starting/receiving stop

Break Error: a break event has been detected on the port

Framing Error: A timing error (i.e. from start bit to stop bit) has been detected on the port

Port I/O Error: An incorrect I/O event has been detected on the port

Rx Overrun: Received data has been overwritten before being processed

Rx Buffer Full Error: The buffer on the receiving end is saturated so that newly arrived data are ignored

Tx Buffer Full Error: The buffer on the transmitting end is saturated so that the data transmitted by applications are ignored.

LB Error - %d: data error is detected in loop back

LB Rx Pending: Loop back mode is waiting for incoming data

Data Setup Error: parameter error in port configuration

Pin Assignments and Wiring

This chapter provides information on the pin assignments and wiring.

Sections include:

- Pin Assignments
- Wiring

Chapter 5 Pin Assignments and Wiring

5.1 Pin assignments

5.1.1 PCI-1601A/AU/B/BU, PCI-1602A/AU/B/BU

The following table and figure shows the pin assignments for the PCI-1601A/B/AU/BU, and PCI-1602A/B/AU/BU cards' male DB9 connectors on the bracket in RS-422 and RS-485 modes.

Table 5.1: PCI-1601/1602 Male DB9 on bracket

Pin	RS-422	RS-485
1	Tx-	Data-
2	Tx+	Data+
3	Rx+	-
4	Rx-	-
5	GND	GND
6	RTS-	-
7	RTS+	-
8	CTS+	-
9	CTS-	-

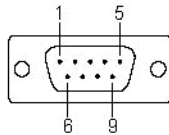

Figure 5.1: PCI-1601/1602 Pin Assignment

5.1.2 PCI-1602UP

The following table and figure show the pin assignments for the PCI-1602UP card's male DB9 on the cable and female DB25 on the bracket in RS-422 and RS-485 modes.

Table 5.2: PCI-1602UP Male DB9 on cable

Pin	RS-422	RS-485
1	Tx-	Data-
2	Tx+	Data+
3	Rx+	-
4	Rx-	-
5	GND	GND
6	RTS-	-
7	RTS+	-
8	CTS+	-
9	CTS-	-

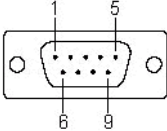
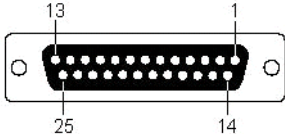

Table 5.3: PCI-1602UP Female DB25 on bracket

Pin	RS-422	RS-485	Pin	RS-422	RS-485
1	2_Tx-	2_Data-	14	2_RTS-	-
2	2_Tx+	2_Data+	15	2_RTS+	-
3	2_Rx+	-	16	2_CTS+	-
4	2_Rx-	-	17	2_CTS-	-
5	2_GND	2_GND	18	-	-
6	-	-	19	-	-
7	-	-	20	-	-
8	-	-	21	-	-
9	1_Tx-	1_Data-	22	1_RTS-	-
10	1_Tx+	1_Data+	23	1_RTS+	-
11	1_Rx+		24	1_CTS+	-
12	1_Rx-		25	1_CTS-	-
13	1_GND	1_GND			



5.1.3 PCI-1603

The following table and figure show the pin assignments for the PCI-1603 card's male DB9 on the bracket in RS-232 and current loop modes.

Table 5.4: PCI-1603 Male DB9 on bracket

Pin	RS-232	Current loop
1	DCD	TxD-
2	RxD	TxD+
3	TxD	RxD+
4	DTR	RxD-
5	GND	-
6	DSR	-
7	RTS	-
8	CTS	-
9	RI	-

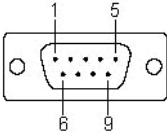

The diagram shows a top-down view of a male DB9 connector. It consists of a rectangular metal housing with a central 9-pin D-sub connector. The pins are arranged in a 3x3 grid. Four pins are specifically labeled with numbers: pin 1 is at the top-left position, pin 5 is at the top-right position, pin 6 is at the bottom-left position, and pin 8 is at the bottom-right position. The remaining pins (2, 3, 4, 7, 9) are not labeled. There are two circular mounting holes on the sides of the housing.

5.1.4 PCI-1604UP

The following table and figure show the pin assignments for the PCI-1604UP card's male DB9 on the cable and female DB25 on the bracket in RS-232 modes.

Table 5.5: PCI-1604 Male DB9 on cable

Pin	RS-232
1	DCD
2	RxD
3	TxD
4	DTR
5	GND
6	DSR
7	RTS
8	CTS
9	RI

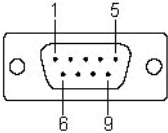
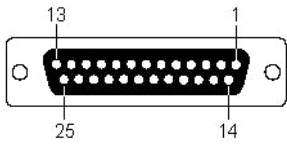

Table 5.6: PCI-1604UP Female DB25 on bracket

Pin	RS-232	Pin	RS-232
1	2_DCD	14	2_DSR
2	2_RxD	15	2_RTS
3	2_TxD	16	2_CTS
4	2_DTR	17	2_RI
5	GND	18	-
6	-	19	-
7	-	20	-
8	-	21	-
9	1_DCD	22	1_DSR
10	1_RxD	23	1_RTS
11	1_TxD	24	1_CTS
12	1_DTR	25	1_RI
13	GND		



5.1.5 PCI-1610A/B/CU

The following table and figure show the pin assignments for the PCI-1610A/B/CU card's male DB9 and male DB25 on the cable and female DB37 on the bracket in RS-232 modes.

Table 5.7: PCI-1610A/B/CU Male DB9 on cable

Pin	RS-232
1	DCD
2	RxD
3	TxD
4	DTR
5	GND
6	DSR
7	RTS
8	CTS
9	RI

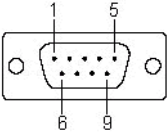

The diagram shows a male DB9 connector with a rectangular housing and two mounting holes. The pins are arranged in a 3x3 grid. Pin 1 is at the top left, pin 5 is at the top right, pin 6 is at the bottom left, and pin 9 is at the bottom right.

Table 5.8: PCI-1610A/B/CU male DB25 on cable

Pin	RS-232
2	TxD
3	RxD
4	RTS
5	CTS
6	DSR
7	GND
8	DCD
20	DTR
22	RI

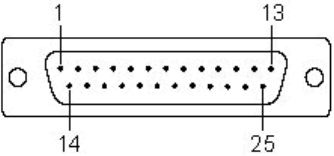

The diagram shows a male DB25 connector with a rectangular housing and two mounting holes. The pins are arranged in a 5x5 grid. Pin 1 is at the top left, pin 13 is at the top right, pin 14 is at the bottom left, and pin 25 is at the bottom right.

Table 5.9: PCI-1610A/B/CU female DB37 on bracket

Pin	RS-232	Pin	RS-232
1	-	20	3_RI
2	3_DCD	21	3_DTR
3	3_GND	22	3_DSR
4	3_CTS	23	3_RTS
5	3_RxD	24	3_TxD
6	4_RI	25	4_DCD
7	4_DTR	26	4_GND
8	4_DSR	27	4_CTS
9	4_RTS	28	4_RxD
10	4_TxD		
		29	2_RI
11	2_DCD	30	2_DTR
12	2_GND	31	2_DSR
13	2_CTS	32	2_RTS
14	2_RxD	33	2_TxD
15	1_RI	34	1_DCD
16	1_DTR	35	1_GND
17	1_DSR	36	1_CTS
18	1_RTS	37	1_RxD
19	1_TxD		

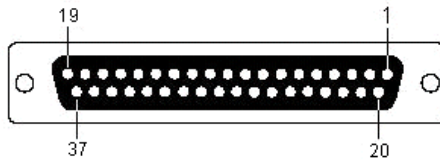

5.1.6 PCI-1610AUP/UP

The following tables and figures show the pin assignments for the PCI-1610AUP/UP card's male DB9 on the cable and female DB44 on the bracket in RS-232 mode.

Table 5.10: PCI-1610AUP/UP male DB9 on cable

Pin	RS-232
1	DCD
2	RxD
3	TxD
4	DTR
5	GND
6	DSR
7	RTS
8	CTS
9	RI

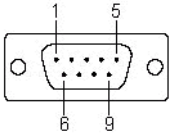
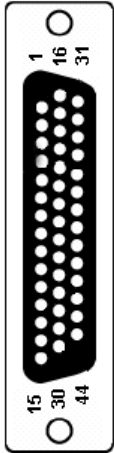

Table 5.11: PCI-1610AUP/UP female DB44 on bracket

Pin	RS-232	Pin	RS-232	Pin	RS-232
1	1_TxD	16	1_CTS	31	1_DCD
2	1_RxD	17	1_DTR	32	1_RI
3	1_RTS	18	1_DSR	33	1_GND
4	-	19	-	34	-
5	2_TxD	20	2_CTS	35	2_DCD
6	2_RxD	21	2_DTR	36	2_RI
7	2_RTS	22	2_DSR	37	2_GND
8	-	23	-	38	-
9	3_TxD	24	3_CTS	39	3_DCD
10	3_RxD	25	3_DTR	40	3_RI
11	3_RTS	26	3_DSR	41	3_GND
12	-	27	-		
13	4_TxD	28	4_CTS	42	4_DCD
14	4_RxD	29	4_DTR	43	4_RI
15	4_RTS	30	4_DSR	44	4_GND



5.1.7 PCI-1610AJU

The following table and figure show the pin assignments for the PCI-1610AJU card's male DB9 on the cable and RJ45 on the bracket in RS-232 modes.

Table 5.12: PCI-1610AJU male DB9 on cable

Pin	RS-232
1	DCD
2	RxD
3	TxD
4	DTR
5	GND
6	DSR
7	RTS
8	CTS

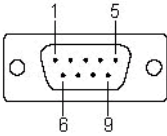

The diagram shows a top-down view of a male DB9 connector. It has a rectangular shape with two circular mounting holes on the left and right sides. There are nine pins arranged in a 2x5 grid. The top row has pins 1 and 5, and the bottom row has pins 6 and 9. Pins 2, 3, 4, and 8 are present but not labeled in this diagram.

Table 5.13: PCI-1610AJU RJ45 on bracket

Pin	RS-232
1	RTS
2	DTR
3	RxD
4	DSR
5	TxD
6	GND
7	DCD
8	CTS



The diagram shows a top-down view of an RJ45 connector. It has a rectangular shape with a central notch. There are eight pins arranged in a single row. The leftmost pin is labeled 8 and the rightmost pin is labeled 1.

5.1.8 PCI-1611U

The following table and figure show the pin assignments for the PCI-1611U card's male DB9 and male DB25 on the cable and female DB37 on the bracket in RS-422 and RS-485 modes.

Table 5.14: PCI-1611U male DB9 on cable

Pin	RS-422	RS-485
1	TxD-	Data-
2	TxD+	Data+
3	RxD+	-
4	RxD-	-
5	GND	GND
6	RTS-	-
7	RTS+	-
8	CTS+	-
9	CTS-	-

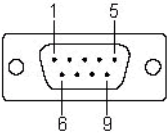

Table 5.15: PCI-1611U male DB25 on cable

Pin	RS-422	RS-485
2	RxD+	-
3	TxD+	Data+
4	RTS+	-
5	CTS+	-
6	RTS-	-
7	GND	GND
8	TxD-	Data-
20	RxD-	-
22	CTS-	-

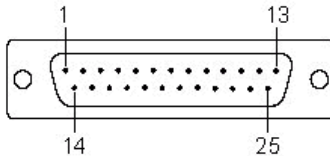
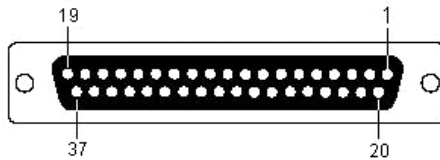

Table 5.16: PCI-1611U female DB37 on bracket

Pin	RS-422	RS-485	Pin	RS-422	RS-485
1	-	-	20	3_CTS-	-
2	3_TxD-	3_Data-	21	3_RxD-	-
3	3_GND	3_GND	22	3_RTS-	-
4	3_CTS+	-	23	3_RTS+	-
5	3_TxD+	3_Data+	24	3_RxD+	-
6	4_CTS-	-	25	4_TxD-	4_Data-
7	4_RxD-	-	26	4_GND	4_GND
8	4_RTS-	-	27	4_CTS+	-
9	4_RTS+	-	28	4_TxD+	4_Data+
10	4_RxD+	-			
			29	2_CTS-	-
11	2_TxD-	2_Data-	30	2_RxD-	-
12	2_GND	2_GND	31	2_RTS-	-
13	2_CTS+		32	2_RTS+	-
14	2_TxD+	2_Data+	33	2_RxD+	-
15	1_CTS-	-	34	1_TxD-	1_Data-
16	1_RxD-	-	35	1_GND	1_GND
17	1_RTS-	-	36	1_CTS+	-
18	1_RTS+	-	37	1_TxD+	1_Data+
19	1_RxD+	-			



5.1.9 PCI-1612A/B/AU/U/CU

The following table and figure show the pin assignments for the PCI-1612A/B/AU/U/CU card's male DB9 and male DB25 on the cable and female DB37 on the bracket in RS-232, RS-422 and RS-485 modes.

Table 5.17: PCI-1612A/B/AU/U/CU male DB9 on cable

Pin	RS-232	RS-422	RS-485
1	DCD	TxD-	Data-
2	RxD	TxD+	Data+
3	TxD	RxD+	-
4	DTR	RxD-	-
5	GND	GND	GND
6	DSR	RTS-	-
7	RTS	RTS+	-
8	CTS	CTS+	-
9	RI	CTS-	-

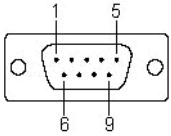

Table 5.18: PCI-1612A/B/AU/U/CU male DB25 on cable

Pin	RS-232	RS-422	RS-485
2	TxD	RxD+	-
3	RxD	TxD+	Data+
4	RTS	RTS+	-
5	CTS	CTS+	-
6	DSR	RTS-	-
7	GND	GND	GND
8	DCD	TxD-	Data-
20	DTR	RxD-	-
22	RI	CTS-	-

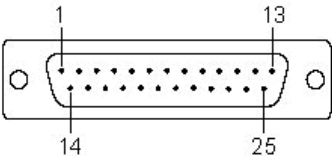
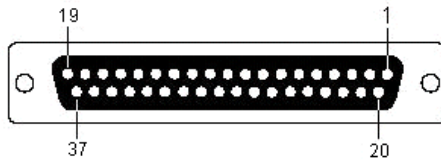

Table 5.19: PCI-1612A/B/AU/U/CU female DB37 on bracket

Pin	RS-232	RS-422	RS-485	Pin	RS-232	RS-422	RS-485
1	-	-	-	20	3_RI	3_CTS-	-
2	3_DCD	3_TxD-	3_Data-	21	3_DTR	3_RxD-	-
3	3_GND	3_GND	3_GND	22	3_DSR	3_RTS-	-
4	3_CTS	3_CTS+	-	23	3_RTS	3_RTS+	-
5	3_RxD	3_TxD+	3_Data+	24	3_TxD	3_RxD+	-
6	4_RI	4_CTS-	-	25	4_DCD	4_TxD-	4_Data-
7	4_DTR	4_RxD-	-	26	4_GND	4_GND	4_GND
8	4_DSR	4_RTS-	-	27	4_CTS	4_CTS+	-
9	4_RTS	4_RTS+	-	28	4_RxD	4_TxD+	4_Data+
10	4_TxD	4_RxD+	-				
				29	2_RI	2_CTS-	-
11	2_DCD	2_TxD-	2_Data-	30	2_DTR	2_RxD-	-
12	2_GND	2_GND	2_GND	31	2_DSR	2_RTS-	-
13	2_CTS	2_CTS+	-	32	2_RTS	2_RTS+	-
14	2_RxD	2_TxD+	2_Data+	33	2_TxD	2_RxD+	-
15	1_RI	1_CTS-	-	34	1_DCD	1_TxD-	1_Data-
16	1_DTR	1_RxD-	-	35	1_GND	1_GND	1_GND
17	1_DSR	1_RTS-	-	36	1_CTS	1_CTS+	-
18	1_RTS	1_RTS+	-	37	1_RxD	1_TxD+	1_Data+
19	1_TxD	1_RxD+	-				



5.1.10 PCI-1620A/B/AU/U

The following tables and figures show the pin assignments for the PCI-1620A/B/AU/U card's female DB62 on the bracket in RS-232 modes and male DB9 if you link cable OPT8H, male DB25 if you link cable or connection box with OPT8BP, OPT8C, and female DB25 if you link connection box with OPT8AP. You could also link the RS-422 device through OPT8FP which is a RS-422 to RS-232 conversion box, so you could link OPT8FP and PCI-1620A/B/AU/U or PCI-1625U, OPT8FP's RS-422 pin assignment is shown as below.

Table 5.20: PCI-1620A/B/AU/U female DB62 on bracket

Pin	RS-232	Pin	RS-232	Pin	RS-232
1	1_TxD	22	1_RxD	43	1_CTS
2	1_DTR	23	1_DSR	44	1_RTS
3	2_RxD	24	1_DCD	45	1_GND
4	2_DSR	25	2_TxD	46	2_CTS
5	2_DCD	26	2_DTR	47	2_RTS
6	3_TxD	27	3_RxD	48	3_CTS
7	3_DTR	28	3_DSR	49	3_RTS
8	4_RxD	29	3_DCD	50	3_GND
9	4_DSR	30	4_TxD	51	4_CTS
10	4_DCD	31	4_DTR	52	4_RTS
11	5_RxD	32	4_GND	53	5_CTS
12	5_DSR	33	5_TxD	54	5_RTS
13	5_DCD	34	5_DTR	55	5_GND
14	6_TxD	35	6_RxD	56	6_CTS
15	6_DTR	36	6_DSR	57	6_RTS
16	7_RxD	37	6_DCD	58	6_GND
17	7_DSR	38	7_TxD	59	7_CTS
18	7_DCD	39	7_DTR	60	7_RTS
19	8_RxD	40	7_GND	61	8_CTS
20	8_DSR	41	8_TxD	62	8_RTS
21	8_DCD	42	8_DTR		

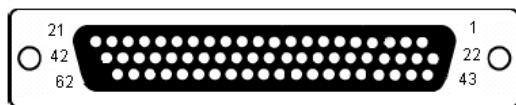
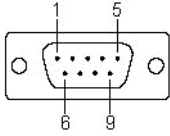

Table 5.21: PCI-1620A/B/AU/U male DB9 on cable (OPT8H)

Pin	RS-232
1	DCD
2	RxD
3	TxD
4	DTR
5	GND
6	DSR
7	RTS
8	CTS



The diagram shows a male DB9 connector with a D-shaped shield. The shield is on the left side. There are nine pins in a single row. Pin 1 is the top-left pin, pin 5 is the top-right pin, pin 6 is the bottom-left pin, and pin 9 is the bottom-right pin. The remaining pins (2, 3, 4, 7, 8) are in the center of the row.

Table 5.22: PCI-1620A/B/AU/U male DB25 on cable (OPT8BP, OPT8C)

Pin	RS-232
2	TxD
3	RxD
4	RTS
5	CTS
6	DSR
7	GND
8	DCD
20	DTR

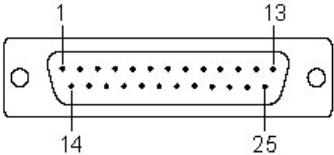

The diagram shows a male DB25 connector with a D-shaped shield. The shield is on the left side. There are 25 pins in two rows: a top row of 13 pins and a bottom row of 12 pins. Pin 1 is the top-left pin, pin 13 is the top-right pin, pin 14 is the bottom-left pin, and pin 25 is the bottom-right pin. The remaining pins are in the center of the rows.

Table 5.23: PCI-1620A/B/AU/U female DB25 on cable (OPT8AP)

Pin	RS-232	
2	RxD	
3	TxD	
4	CTS	
5	RTS	
6	DTR	
7	GND	
8	DCD	
20	DSR	

Table 5.24: PCI-1620A/B/AU/U female DB25 on cable (OPT8FP)

Pin	RS-422	
2	RxD+	
3	TxD+	
7	GND	
14	RxD-	
16	TxD-	

5.1.11 PCI-1622CU

The following table and figure show the pin assignments for the PCI-1622CU card's female DB78 on the bracket in RS-422 and RS-485 modes and male DB9 if you link cable OPT8J, male DB25 if you link cable with OPT8I.

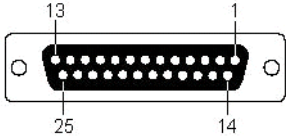
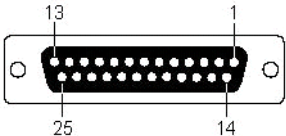
Table 5.25: PCI-1622CU male DB9 on cable (OPT8J)

Pin	RS-422	RS-485
1	TxD-	Data-
2	TxD+	Data+
3	RxD+	-
4	RxD-	-
5	GND	GND
6	RTS-	-
7	RTS+	-
8	CTS+	-
9	CTS-	-

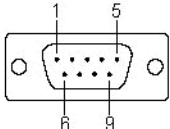

Table 5.26: PCI-1622CU male DB25 on cable(OPT8I)

Pin	RS-422	RS-485
2	RxD+	-
3	TxD+	Data+
4	RTS+	-
5	CTS+	-
6	RTS-	-
7	GND	GND
8	TxD-	Data-
20	RxD-	-
22	CTS-	-

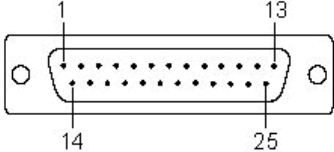

Table 5.27: PCI-1622CU female DB78 on bracket

Pin	RS-422	RS-485	Pin	RS-422	RS-485
1	8_GND	8_GND	40	8_TxD-	8_Data-
2	8_RTS-		41	8_TxD+	8_Data+
3	8_RTS+		42	7_GND	7_GND
4	7_RTS-		43	7_TxD-	7_Data-
5	7_RTS+		44	7_TxD+	7_Data+
6	6_RTS-		45	6_TxD-	6_Data-
7	6_RTS+		46	6_TxD+	6_Data+
8	-		47	5_GND	5_GND
9	5_RTS-		48	5_TxD-	5_Data-
10	5_RTS+		49	5_TxD+	5_Data+
11	4_RTS-		50	4_TxD-	4_Data-
12	4_RTS+		51	4_TxD+	4_Data+
13	-		52	3_GND	3_GND
14	3_RTS-		53	3_TxD-	3_Data-
15	3_RTS+		54	3_TxD+	3_Data+
16	2_RTS-		55	2_TxD-	2_Data-
17	2_RTS+		56	2_TxD+	2_Data+
18	-		57	1_GND	1_GND
19	1_RTS-		58	1_TxD-	1_Data-
20	1_RTS+		59	1_TxD+	1_Data+
21	8_CTS+		60	8_RxD+	
22	8_CTS-		61	8_RxD-	
23	7_CTS+		62	7_RxD+	
24	7_CTS-		63	7_RxD-	
25	-		64	6_GND	6_GND
26	6_CTS+		65	6_RxD+	
27	6_CTS-		66	6_RxD-	
28	5_CTS+		67	5_RxD+	
29	5_CTS-		68	5_RxD-	
30	-		69	4_GND	4_GND

Table 5.27: PCI-1622CU female DB78 on bracket

31	4_CTS+		70	4_RxD+	
32	4_CTS-		71	4_RxD-	
33	3_CTS+		72	3_RxD+	
34	3_CTS-		73	3_RxD-	
35	-		74	2_GND	2_GND
36	2_CTS+		75	2_RxD+	
37	2_CTS-		76	2_RxD-	
38	1_CTS+		77	1_RxD+	
39	1_CTS-		78	1_RxD-	

5.2 Wiring

5.2.1 RS-232 Signal Wiring

Since the RS-232 interface is not strictly defined, many devices have their own connection methods which may ignore some signal lines or define reserved lines for other functions. It is best to refer to the user's manual for your device for installation instructions. You may find the following helpful.

In general, DTE (Data Terminal Equipment) refers to the device that is leading the communication. Examples include PC's, terminals and some printers. DCE refers to the device being communicated with or controlled. Examples include modems, DSU's (digital service units), printers and lab/factory equipment.

In some situations you may be able to get by with just three lines: data on TXD, a signal ground and a handshaking line. Examples are printer or plotter connections, troubleshooting and situations where you require only one-wire communication.

Table 5.28: Terminal or PC (DTE) Connections

DB-25 Male		DB-25 Male or Female: Terminal	
Pin	Signal	Pin	Signal
2	TxD	3	RxD
3	RxD	2	TxD
4	RTS	5	CTS
5	CTS	4	RTS
6	DSR	20	DTR
7	GND	7	GND
20	DTR	6	DSR
8	DCD	8	DCD

Table 5.29: Modem Connections

DB-25 Male		Modem (DCE)	
Pin	Signal	Pin	Signal
2	TxD	2	RxD
3	RxD	3	TxD
4	RTS	4	CTS
5	CTS	5	RTS
6	DSR	6	DTR
7	GND	7	GND
20	DTR	20	DSR
8	DCD	8	DCD

For DTE to DCE connections, use a straight through cable (i.e., you don't have to reverse lines 2 and 3, lines 4 and 5, and lines 6 and 20 since, in general, the DCE RS-232 interfaces are reversed themselves).

Table 5.30: Terminal without Handshake

DB-25 Male		Terminal, PC (DTE)	
Pin	Signal	Pin	Signal
2	TxD	3	RxD
3	RxD	2	TxD
4	RTS —		
5	CTS —		
7	GND	7	GND
6	DSR —		
20	DTR —		
8	DCD —		

Therefore, if you are not using CTS, RTS, DSR, DTR and DCD signals, please short pins 4 and 5 together, and please short pins 6, 8, and 20 together.

5.2.2 RS-422 Signal Wiring

The RS-422 interface wiring is based on one-to-one principles. The transmit lines on one side connect to the receive lines on the other side, and vice versa. With RS-422, you can transmit and receive data simultaneously (full duplex). The connections are as follows:

Table 5.31: RS-422 DB9 Pin Assignment

DTE(Male DB-9)		Terminal DTE	
Pin	Signal	Pin	Signal
1	TxD-	1	RxD-
2	TxD+	2	RxD+
3	RxD+	3	TxD+
4	RxD-	4	TxD-
5	GND	5	GND
6	RTS-	6	CTS-
7	RTS+	7	CTS+
8	CTS+	8	RTS+
9	CTS-	9	RTS-

Terminator Resistors Setup

The signals DSR, DTR and DCD are shorted internally on the PCI-1601/1602/1611/1612/1622 cards when operating in RS-422 mode.

A user can solder in termination resistors if necessary for impedance matching. The card has two mounting spaces for termination resistors, but no resistors are installed at the factory. Each pair of signal lines has a separate resistor (RxD+/-, TxD+/-).

5.2.3 RS-485 Signal Wiring

The RS-485 standard supports half-duplex communication. This means that just two wires are needed to both transmit and receive data. Handshaking signals (such as RTS, Request To Send) are normally used to control the direction of the data flow and to switch the transmission accordingly. In RS-485 mode, the PCI-1601/1602/1611/1612/1622 cards automatically sense the direction of the data flow and switch the transmission direction — no handshaking is necessary. This means a user can build an RS-485 network with just two wires. This RS-485 control is completely transparent to the user. The software written for half duplex RS-232 works without any modification.

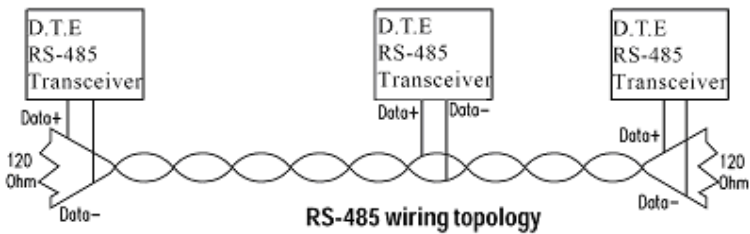

Figure 5.2: RS-485 Wiring Topology

Termination Resistor Setup

You can install termination resistors if necessary for impedance matching. The card has mounting spaces for termination resistors, but no resistors are installed at the factory. Depending on your application you may need to solder in a single resistor to handle the DATA+/DATA- pair (**and a corresponding resistor on the other end of the connection**). The value of the resistor should equal the characteristic impedance of the signal wires (approximately 120 Ohms or 300 Ohms).

