

ADAM-5510KW Series

**PC-based SoftLogic Controller
User's Manual**

ADAM-5510KW Series

PC-based SoftLogic Controller User's Manual

Copyright Notice

This document is copyrighted, 1997, by Advantech Co., Ltd. All rights are reserved. Advantech Co., Ltd., reserves the right to make improvements to the products described in this manual at any time without notice.

No part of this manual may be reproduced, copied, translated or transmitted in any form or by any means without the prior written permission of Advantech Co., Ltd. Information provided in this manual is intended to be accurate and reliable. However, Advantech Co., Ltd. assumes no responsibility for its use, nor for any infringements upon the rights of third parties, which may result from its use.

Acknowledgments

ADAM is a trademark of Advantech Co., Ltd.

IBM and PC are trademarks of International Business Machines Corporation.

MULTIPROG is a trademark of KW-Software GmbH.

Edition 1.2
Aug. 2007

Table of Contents

Chapter 1 System Overview	1-1
1.1 Introduction	1-2
1.2 Features	1-2
1.2.1 Process IEC 61131-3 standard with rich development environment	1-3
1.2.2 Cross-Language Programming.....	1-4
1.2.3 Rich memory size for programming and storage.....	1-4
1.2.4 Real time multi-task engine	1-5
1.2.5 Pre-defined function library.....	1-5
1.2.6 Powerful debug / diagnostic / simulation / force tools.....	1-5
1.2.7 Open Standard connection - Modbus standard Interface.....	1-6
1.2.8 Online editing & partial download.....	1-6
1.2.9 RS-232/485 communication ability.....	1-6
1.2.10 Built-in SRAM and Flash disk for programming.....	1-7
1.2.11 Built-in real-time clock and watchdog timer.....	1-7
1.2.12 Complete set of I/O modules for total solutions.....	1-8
1.2.13 Built-in Ethernet Port (ADAM-5510EKW/TP only).....	1-9
1.3 ADAM-5510KW Series Controller Specification.....	1-9
1.3.1 System.....	1-9
1.3.2.1 RS-232 interface (COM1) for ADAM-5510KW.....	1-10
1.3.2.2 RS-232/485 interface (COM1) for ADAM-5510EKW and ADAM-5510EKW/TP.....	1-10
1.3.3 RS-485 interface (COM2) (For SCADA/HMI Software).....	1-10
1.3.4 RS-232 debug port (COM3) (For debug/maintenance only)....	1-10
1.3.5 RS-232/485 interface (COM4) (For remote I/O modules).....	1-10
1.3.6 Isolation.....	1-11
1.3.7 Power.....	1-11
1.3.8 Mechanical.....	1-11
1.3.9 Environment.....	1-11
1.3.10 Software Specification.....	1-11
1.3.11 Dimensions.....	1-11
1.3.12 LED Status.....	1-12
1.4 Limitation.....	1-14
1.4.1 Performance / Speed.....	1-14
1.4.2 Remote I/O Quantity.....	1-14
1.4.3 Memory size.....	1-14
1.4.4 TCP/IP Connections.....	1-15
1.4.5 Firmware Upgrade Notice.....	1-15

Chapter 2 Installation Guidelines.....	2-1
2.1 System Requirements.....	2-2
2.1.1 Host Computer Requirements.....	2-2
2.1.2 ADAM-5510KW Series Requirements.....	2-2
2.1.3 I/O Module Requirements.....	2-2
2.2 Hardware Installation.....	2-4
2.2.1 Selecting I/O Module.....	2-4
2.2.2 Selecting Power Supply Module.....	2-8
2.2.3 Install Main Unit and Modules.....	2-10
2.2.4 I/O Slots and I/O Channel Numbering.....	2-11
2.2.5 Mounting.....	2-12
2.2.6 Jumper Settings and DIP Switch Settings.....	2-14
2.2.6.1 COM2 port RS-485 control mode setting.....	2-15
2.2.6.2 Watchdog timer setting.....	2-16
2.2.6.3 Battery backup setting.....	2-16
2.2.6.4 RS-232/485 selectable jumper setting.....	2-17
2.2.6.5 DIP Switch Setting.....	2-18
2.2.7 Pin assignment of COM port.....	2-21
2.3 System Wiring and Connections.....	2-22
2.3.1 Power supply wiring.....	2-22
2.3.2 I/O modules wiring.....	2-23
2.3.3 Connection of Communication Ports.....	2-23
2.3.3.1 MULTIPRO Programming Wiring.....	2-23
2.3.3.2 Modbus/RTU Slave Wiring.....	2-26
2.3.3.3 Multi-connection Master/Slave Wiring.....	2-28
2.3.3.4 Remote I/O Wiring.....	2-29
2.3.3.5 Programming Port Wiring for Maintenance.....	2-30
2.3.4 Ethernet Network Connection.....	2-31
Chapter 3 Quick Start	3-1
3.1 I/O Module Configuration.....	3-4
3.2 Software Installation.....	3-8
3.3 Create a Project and Test the System.....	3-21
Chapter 4 Multiprog via Ethernet	4-1
4.1 Configure IP address when firmware version is 1.21 or later.....	4-2

4.2 Configure IP address when firmware version is less than 1.21.....	4-13
4.3 Multiprog via Ethernet port.....	4-17
Chapter 5 Modbus Functions	5-1
5.1 Introduction.....	5-2
5.2 Modbus/RTU Master Function.....	5-2
5.2.1 An example to demonstrate how to connect COM4 to ADAM-4015T for Modbus/RTU master function.....	5-3
5.2.2 Following example can show how to connect COM4 to ADAM-4056S for Modbus/RTU master function.....	5-8
5.3 Modbus/RTU Slave Function.....	5-11
5.3.1 Modbus Address Mapping for local I/O points.....	5-11
5.3.2 Modbus Address Mapping.....	5-12
5.4 Modbus/TCP Server Function.....	5-17
5.5 Modbus/TCP Client Function.....	5-17
Chapter 6 ADAM-5000 Function Blocks.....	6-1
6.1 Example of AI Function Block.....	6-4
6.2 Example of AO Function Block.....	6-7
6.3 Example of DI/DO Function Block.....	6-10
6.4 Example of Move Function Block “INT to MB42XXX” ...	6-14
6.5 Example of MMA, SCALE_BIAS and SCALE function blocks.....	6-19
6.6 Example of CALENDAR Function Block.....	6-21
6.7 Example of Communication Function Block.....	6-24
Chapter 7 Miscellaneous Functions	7-1
7.1 Firmware Upgrade	7-2
7.2 Save Project Source on ADAM-5510KW Series Controller	7-8
7.3 Upload Project Source from ADAM-5510KW Series Controller	7-10
7.4 Example of changing Language Interface from English to Traditional Chinese.....	7-14
Appendix A COM Port Register Structure	A-1

Appendix B Data Formats and I/O Ranges	B-1
Appendix C RS-485 Network	C-1
Appendix D Grounding Reference	D-1
Appendix E Reference Documents	E-1

1

System Overview

Chapter 1 System Overview

1.1 Introduction

PC-based SoftLogic Control System

ADAM-5510KW Series Controller is PC-based SoftLogic controller features IEC-61131-3 standard programming languages which will satisfy the customers who are familiar with Ladder Diagram, Function Block Diagram, Sequential Function Chart, Instruction List and Structured Text. With IEC-61131-3 technology, one automation system can be easily leveraged to different applications. This reduces engineers' efforts to learn proprietary programming tools and saves investment costs.

ADAM-5510KW Series Controller is x86-based architecture inside with rich memory and bundled with KW-Software ProConOS run-time engine and MultiProg programming software. The ADAM-5510KW Series Controller includes three models as following:

- **ADAM-5510KW** 4-slot PC-based SoftLogic Controller
- **ADAM-5510EKW** 8-slot PC-based SoftLogic Controller
- **ADAM-5510KW/TCP** 4-slot Ethernet-enabled SoftLogic Controller
- **ADAM-5510EKW/TP** 8-slot Ethernet-enabled SoftLogic Controller

1.2 Features

The hardware system of ADAM-5510KW Series Controller consists of two major components: the main unit and I/O modules. The main unit includes a CPU card, a power module, a 4-slot or 8-slot backplane, three serial communication ports and one debug/programming port. ADAM-5510EKW/TP and ADAM-5510KW/TCP also embeds one Ethernet port. The Multiprog software is also needed for developing the control program for ADAM-5510KW Series Controller. Following are the major features:

- Process IEC-61131 standard with rich development environment
- Cross-Language programming
- Rich memory size for programming and storage

Chapter 1 System Overview

- Real time multi-task engine
- Free pre-defined function library
- Powerful debug / diagnostic / simulation / force tools
- Open Standard connection-Modbus standard Interface
- Online editing & partial download
- RS-232/485 communication ability
- Built-in Flash disk and RAM for programming
- Built-in real-time clock and watchdog timer
- Complete set of I/O modules for total solutions
- Built-in Ethernet Port (ADAM-5510EKW/TP and ADAM-5510KW/TCP only)

1.2.1 Process IEC 61131-3 standard with rich development environment

The standard IEC 61131-3 has been established to standardize the multiple languages, sets of instructions and different concepts existing in the field of automation systems. The great variety of control concepts has led to an incompatibility between the different control platforms and manufacturers. The result was a great effort to be made for training, hardware and software investments.

IEC 61131-3 defines the syntax of 5 programming languages, defines a certain representation and describes the different elements which can be used in the language.

The programming languages can be differentiated by the physical appearance into 2 textual languages and 3 graphical languages.

Textual Languages	Graphical Languages
Instruction List (IL) Structured Text (ST)	Function Block Diagram (FBD) Ladder Diagram (LD) Sequential Function Chart (SFC)

Table 1-1 Programming Languages Table

Chapter 1 System Overview

1.2.2 Cross-Language Programming

For some project integrate and scalable issues, cross-language can help you to choose the different language for your project. For example, you can use ladder (LD) on the simple I/O module control or simple logical expression and use Function Block (FB) on process control for more advanced expression and use Sequential Function Chart (SFC) for system configuration in hybrid control system such as Water Treatment.

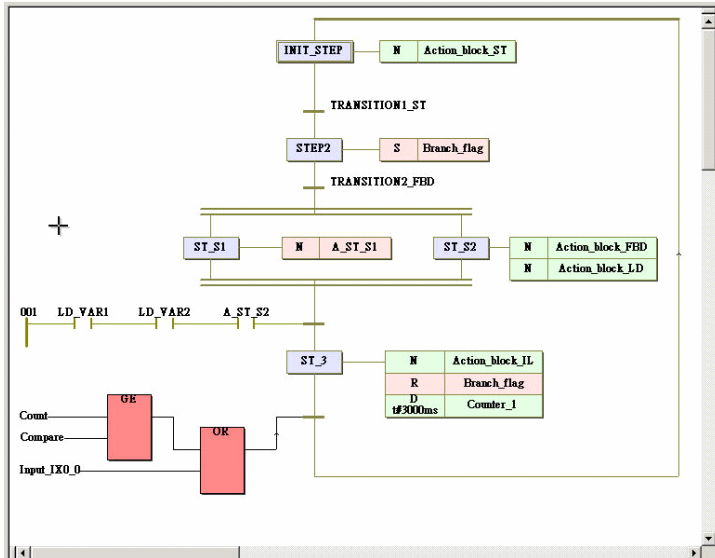

Figure 1-1 Cross-Language Programming

1.2.3 Rich memory size for programming and storage

ADAM-5510KW Series Controller supports 640KB system memory and 1MB flash disk. With this rich memory, you can expand your program size for more tags and expressions. Beside, the storage size is also growing up with this large memory size.

For System Use

256 KB system ROM

256 KB flash memory

640 KB SRAM, up to 32KB with battery backup

For Programming Use

1 MB flash disk with file system and up to 150KB for user's application

1.2.4 Real time multi-task engine

ADAM-5510KW Series Controller provides the multi-task and multi-program environment. ADAM-5510KW Series Controller's communication, data process and I/O access tasks are working independent, so the system performance and efficiency are better than traditional PLC.

1.2.5 Pre-defined function library

Advantech Multiprog provides many pre-defined function library such as maximum of strings as string function block, Convert REAL to INT as type convert function block. It helps you to build up your program more conveniently. It is more convenient than the traditional control programming tools. With this pre-defined function, you can make your project easier in timer control, variable type conversion or strings conversion, etc. In addition, users can define their own function block for common use function or special domain know-how.

1.2.6 Powerful debug / diagnostic / simulation / force tools

Advantech Multiprog provides lots of powerful tools for debug, diagnostic, simulation and force function. It shows friendly interfaces when you use these tools. With debug / diagnostic tools, you can make it easier on trouble-shooting. Advantech MULTIPROG simulator supports program verification offline directly on your PC. This is great in case you are developing logic and you do not have access to a controller. To activate an I/O simply click on the LED you want to energize and your logic executes as if it was a real I/O. The result? The program operation is the same as if you actually were connected to the controller, so all the debug tools are fully functional: power and logic flow, I/O force and overwriting. With force tools, you can check more exception situations and check if the project handling right or wrong. It prevents the damage for you.

Chapter 1 System Overview

1.2.7 Open Standard connection - Modbus standard Interface

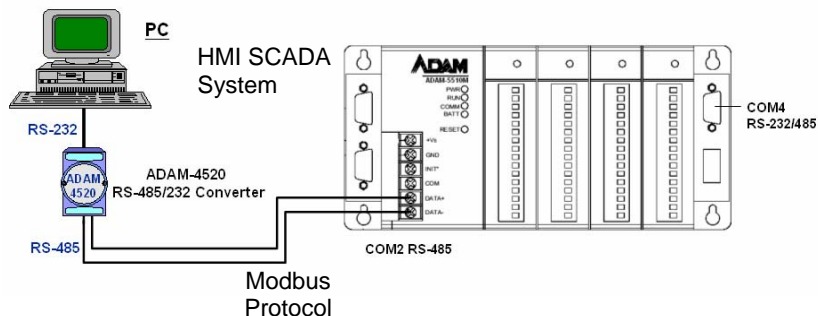

Figure 1-2 Modbus connection support

With Modbus protocol, you can integrate your system through most of HMI SCADA system or OPC Server and even HMI SCADA with OPC Server. It helps you to integrate control I/O system and plant system easier.

1.2.8 Online editing & partial download

Online editing is a MUST even though many packages do not support it. It is unacceptable to shut down the machine or process to perform maintenance, not to mention how difficult it is to debug when you have to switch back and forth from program to run mode. Multiprog supports online editing so you can make changes and then download the changes to the controller **WITHOUT** stopping the machine or process. It helps you to maintain your system easier and save the cost for your system process.

1.2.9 RS-232/485 communication ability

The ADAM-5510KW Series Controller has four serial communication ports, giving it excellent communication abilities. This facilitates its ability to control networked devices. The communication ports of different models are listed as below table.

	ADAM-5510KW	ADAM-5510EKW	ADAM-5510KW/TCP	ADAM-5510EKW/TP
COM1	RS-232	RS-232/485	RS-232	RS-232/485
COM2	RS-485	RS-485	RS-485	RS-485
COM3	RS-232(Reserved)	RS-232(Reserved)	RS-232(Reserved)	RS-232(Reserved)
COM4	RS-232/485	RS-232/485	RS-232/485	RS-232/485

Table 1-2 Communication Ports of ADAM-5510KW Series Controller

Chapter 1 System Overview

For example, ADAM-5510KW COM1 is a dedicated RS-232 port, COM2 is a dedicated RS-485 port, and COM4 is a RS-232/485 selectable port. These three ports allow the ADAM-5510KW to satisfy diverse communication and integration demands. With this communication ports, you should not buy more I/O communication device and save more costs. You can also extend your system by using these communication ports. Please refer to following figure and check the location of COM ports.

Note: COM3 is a reserved debug/programming port for maintenance purpose.

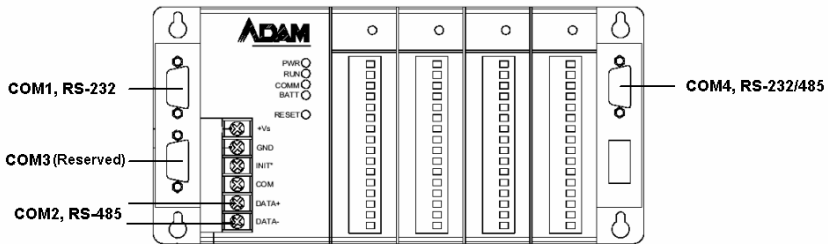

Figure 1-3 ADAM-5510KW Communication Ports

1.2.10 Built-in SRAM and Flash disk for programming

The ADAM-5510KW Series Controller has built-in Flash Memory and SRAM for file downloading, system operation and data storage. It provides 1 MB file system, up to 150 KB free space for users to download programs. There are also 640KB SRAM to provide the memory needed for efficient application operation and file transfer. Moreover, users are allowed to decide the battery backup memory size up to 32KB on the SRAM.

1.2.11 Built-in real-time clock and watchdog timer

The ADAM-5510KW Series Controller also includes a real-time clock and watchdog timer. The real-time clock records events while they occur. The watchdog timer is designed to automatically reset the microprocessor if the system fails. ADAM-5510KW Series Controller provides three types of watchdog timers. They are Operating System Watchdog, KW application watchdog and Modbus server communication watchdog. It will increase the

Chapter 1 System Overview

reliability of system and make the ADAM-5510KW Series Controller ideal for use in applications which require high system stability.

1.2.12 Complete set of I/O modules for total solutions

The ADAM-5510KW Series Controller uses a convenient backplane system for supporting versatile I/O modules. Advantech's complete line of ADAM-5000 I/O modules integrates with the ADAM-5510KW Series Controller to support your applications. Following table is the I/O module support list we provided for user's choice.

Module	Name	Specification	Reference
Analog I/O	ADAM-5013	3-ch. RTD input	Isolated
	ADAM-5017	8-ch. AI	Isolated
	ADAM-5017H	8-ch. High speed AI	Isolated
	ADAM-5018	7-ch. Thermocouple input	Isolated
	ADAM-5024	4-ch. AO	Isolated
Digital I/O	ADAM-5050	7-ch. D I/O	Non-isolated
	ADAM-5051	16-ch. DI	Non-isolated
	ADAM-5051D	16-ch. DI w/LED	Non-isolated
	ADAM-5051S	16-ch. Isolated DI w/LED	Isolated
	ADAM-5052	8-ch. DI	Isolated
	ADAM-5055S	16-ch. Isolated DI/O w/LED	Isolated
	ADAM-5056	16-ch. DO	Non-isolated
	ADAM-5056D	16-ch. DO w/LED	Non-isolated
	ADAM-5056S	16-ch. Isolated DO w/LED	Isolated
	ADAM-5056SO	16-ch. Iso. DO w/LED (source)	Isolated
Relay Output	ADAM-5060	6-ch. Relay output	Isolated
	ADAM-5068	8-ch. Relay output	Isolated
	ADAM-5069	8-ch. Power Relay output	Isolated
Counter/Frequency	ADAM-5080	4-ch. Counter/Frequency	Isolated
Serial I/O	ADAM-5090	4-port RS-232	Non-isolated

Table 1-3 I/O Module Support List

Note: 1. ADAM-5090 supports Communication Function Block only.
2. For details, refer to ADAM-5000 I/O Module User's Manual.

1.2.13 Built-in Ethernet Port (ADAM-5510EKW/TP only)

The Ethernet port on ADAM-5510EKW/TP can perform powerful functions as following.

- Modbus/TCP Server for connecting SCADA/HMI Software
- Modbus/TCP Client for connecting remote I/O modules
- Multiprog protocol via Ethernet for Multiprog OPC server connection.

1.3 ADAM-5510KW Series Controller Specification

1.3.1 System

- CPU: 80188-40, 16-bit microprocessor
- Operating system: Boot ROM-DOS
- 512 KB file system for Drive D
- 256 KB system ROM (for system use)
- 768 KB flash memory (for system use)
- SRAM: 640 KB
- Battery backup:
 - ADAM-5510KW and ADAM-5510EKW:
32 KB (16 KB for Modbus, 16 KB for KW retain data)
 - ADAM-5510EKW/TP and ADAM-5510KW/TCP:
11 KB (4 KB for Modbus, 7KB for KW retain data)
- Timer BIOS: Yes
- Real-time clock: Yes
- Watchdog timer: Yes
 - Operating System Watchdog
 - KW application watchdog
 - Modbus server communication watchdog
- COM1: RS-232(ADAM-5510KW), DB-9 connector
RS-232/485 selectable (ADAM-5510EKW and ADAM-5510EKW/TP), DB-9 connector
- COM2: RS-485, Terminal Block
- COM3: Debug/Programming port (for system maintenance only)
(RS-232 interface, DB-9 connector): Tx, Rx, GND
- COM4: RS-232/485 selectable, DB-9 connector
- I/O capacity:
 - 4 slots (ADAM-5510KW and ADAM-5510KW/TCP)
 - 8 slots (ADAM-5510EKW and ADAM-5510EKW/TP)
- CPU power consumption: 1.0 W

Chapter 1 System Overview

1.3.2.1 RS-232 interface (COM1) for ADAM-5510KW

- Signals: TxD, RxD, RTS, CTS, DTR, DSR, DCD, RI, GND
- Mode: Asynchronous full duplex, point to point
- Connector: DB-9 pin
- Transmission speed: Up to 115.2 Kbps
- Max transmission distance: 50 feet (15.2 m)

1.3.2.2 RS-232/485 interface (COM1) for ADAM-5510EKW and ADAM-5510EKW/TP

- RS-232/485 Mode selectable by jumper
- RS-232 Mode: Asynchronous full duplex, point to point
Signals: TxD, RxD, RTS, CTS, DTR, DSR, DCD, RI, GND
- RS-485 Mode: Half duplex, multi-drop
Signal: DATA+, DATA-
- Connector: DB-9 pin
- Transmission speed: Up to 115.2 Kbps
- Max transmission distance:
RS-232: 50 feet (15.2 m)
RS-485: 4,000 feet (1220 m)

1.3.3 RS-485 interface (COM2) (For SCADA/HMI Software)

- Signals: DATA+, DATA-
- Mode : Half duplex, multi-drop
- Connector: Screw terminal
- Transmission speed: Up to 115.2K bps
- Max transmission distance: 4000 feet (1220 m)

1.3.4 RS-232 debug port (COM3) (For debug/maintenance only)

- Signals: Tx, Rx, GND
- Mode: Asynchronous, point to point
- Connector: DB-9 pin
- Transmission speed: Up to 115.2K bps
- Max transmission distance: 50 feet (15.2 m)

1.3.5 RS-232/485 interface (COM4) (For remote I/O modules)

- RS-232/485 Mode selectable by jumper
RS-485 Signal: DATA+, DATA-
- RS-232 Mode: Asynchronous full duplex, point to point
Signals: TxD, RxD, RTS, CTS, DTR, DSR, DCD, RI, GND
- RS-485 Mode: Half duplex, multi-drop
RS-485 Signal: DATA+, DATA-
- Connector: DB-9
- Transmission speed: Up to 115.2K bps

- Max transmission distance:
RS-232: 50 feet (15.2 m)
RS-485: 4000 feet (1220 m)

1.3.6 Isolation

- Power: 3000 V_{DC}
- Communication: 2500 V_{DC} (COM2 only)

1.3.7 Power

- Unregulated +10 to +30 VDC
- Protected against power reversal
- Power consumption: 2.0 W

1.3.8 Mechanical

- Case: ABS with captive mounting hardware
- Plug-in screw terminal block:
Accepts 0.5 mm² to 2.5 mm², 1 - #12 or 2 - #14 to #22 AWG

1.3.9 Environment

- Operating temperature: -10° to 70° C (14° to 158° F)
- Storage temperature: -25° to 85° C (-13° to 185° F)
- Humidity: 5 to 95 %, non-condensing
- Atmosphere: No corrosive gases

NOTE: Equipment will operate below 30% humidity. However, static electricity problems occur much more frequently at lower humidity levels. Make sure you take adequate precautions when you touch the equipment. Consider using ground straps, anti-static floor coverings, etc. if you use the equipment in low humidity environments.

1.3.10 Software Specification

- Real Time O.S: KW ProConOS (Up to 16 tasks)
- Programmable Code/Data Size: up to 64 KB

1.3.11 Dimensions

The following diagrams show the dimensions of the system unit and an I/O unit. All dimensions are in millimeters.

Chapter 1 System Overview

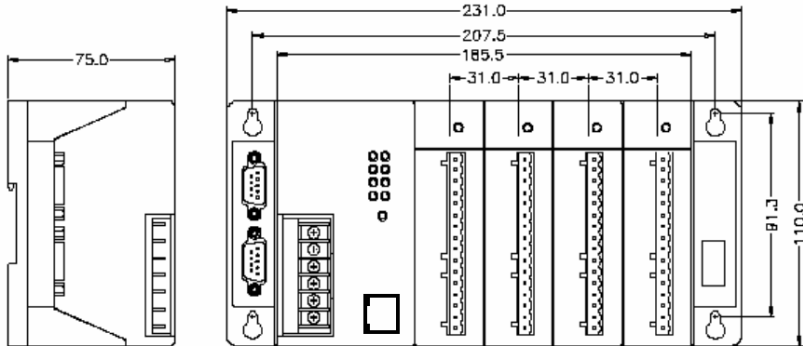

Figure 1-4 ADAM-5510KW Dimension

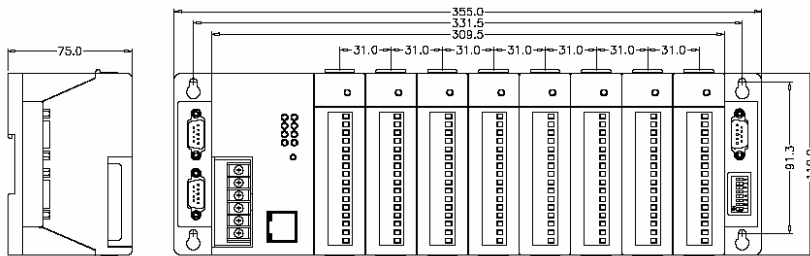

Figure 1-5 ADAM-5510EKW and ADAM-5510EKW/TP Dimension

1.3.12 LED Status

ADAM-5510KW and ADAM-5510EKW:

There are four LEDs on the ADAM-5510KW and ADAM-5510EKW front panel. The LED's indicate ADAM-5510KW and ADAM-5510EKW's operating status, as explained below:

- (1) **PWR**: power indicator. This LED is on whenever the ADAM-5510KW or ADAM-5510EKW is powered on.
- (2) **RUN**: program execution indicator. This LED is regularly blinks whenever the ADAM-5510KW or ADAM-5510EKW is executing a program.
- (3) **COMM**: communication indicator. This LED blinks whenever the host PC and the ADAM-5510KW or ADAM-5510EKW are communicating. Please notice: if the host COM port is connected to the ADAM-5510KW or ADAM-5510EKW's

Chapter 1 System Overview

COM1, this LED will normally be off. On the other hand, if the host COM port is connected to the ADAM-5510KW and ADAM-5510EKW's COM2, this LED will normally be on.

- (4) **BATT**: battery status indicator. This LED will be on whenever the SRAM backup battery is low.

ADAM-5510EKW/TP:

There are eight LEDs on the ADAM-5510EKW/TP front panel. The LED's indicate operating status, as explained below:

- (1) **PWR**: power indicator. This LED is on whenever the ADAM-5510EKW/TP is powered on.
- (2) **RUN**: program execution indicator. This LED is regularly blinks whenever the ADAM-5510EKW/TP is executing a program.
- (3) **COMM**: communication indicator. This LED blinks whenever the host PC and the ADAM-5510EKW/TP is communicating. Please notice: if the host COM port is connected to the ADAM-5510EKW/TP COM1, this LED will normally be off. On the other hand, if the host COM port is connected to the ADAM-5510EKW/TP's COM2, this LED will normally be on.
- (4) **BATT**: battery status indicator. This LED will be on whenever the SRAM backup battery is low.
- (5) **Speed**: This LED is on when the Ethernet communication speed is 100 Mbps.
- (6) **Link**: This LED is normal on whenever the Green indicator. This LED is on when the ADAM-5510EKW/TP's Ethernet wiring is connected.
- (7) **TX**: This LED blinks whenever the ADAM-5510EKW/TP transmitting data to Ethernet.
- (8) **RX**: This LED blinks whenever the ADAM-5510EKW/TP receiving data from Ethernet.

Chapter 1 System Overview

1.4 Limitation

1.4.1 Performance / Speed

The initial scan time is 4.1 ms/KB.

The scan time will increase with an average of 0.4 ms when the program size increases with 1 KB

1.4.2 Remote I/O Quantity

ADAM-5510KW Series Controller can connect to ADAM-4000 Modbus I/O modules through COM4 by Modbus protocol. The typical quantity of remote I/O connection is 32.

ADAM-5510KW Series Controller supports both Modbus/RTU master and Modbus/TCP client functions for connecting remote I/O modules. **However, please note you can only select ONE of the functions for one ADAM-5510KW Series Controller.** In other words, If you select to use Modbus/RTU master function for ADAM-4000 Modbus I/O modules, it is not supported to use Modbus/TCP client for ADAM-6000 I/O modules simultaneously.

1.4.3 Memory size

ADAM-5510KW Series Controller enlarges the memory size for programming use and system unit. It contains system ROM, flash memory, SRAM and files system memory for user's application,

- 256 KB system ROM (for system use)
- 768 KB flash memory (for system use)
- 512 KB flash disk (for system use)
- 640 KB SRAM:
 - Battery backup size:
 - ADAM-5510KW and ADAM-5510EKW:
32 KB (16 KB for Modbus, 16 KB for KW retain data)
 - ADAM-5510EKW/TP and ADAM-5510KW/TCP:
11 KB (4 KB for Modbus, 7KB for KW retain data)
 - Maximum size of application program
 - ADAM-5510KW and ADAM-5510EKW: 150KB
 - ADAM-5510EKW/TP and ADAM-5510KW/TCP: 70KB
- Maximum Storage Size for KW Source File: 512KB

1.4.4 TCP/IP Connections

- Multiprog via Ethernet connection: maximum 4 connections
- Modbus/TCP Server connection: maximum 4 connections

1.4.5 Firmware Upgrade Notice

When you would like to upgrade the firmware of ADAM-5510KW Series Controller, please follow the procedures in section 7.1 carefully. If you have any question, please do contact with Advantech Technical Support Team for making sure the upgrade procedures and latest firmware files. Wrong procedures will possibly cause potential problem in your system.

2

Installation Guidelines

Chapter 2 Installation Guidelines

This chapter describes how to install an ADAM-5510KW Series Controller. A quick hookup scheme including both 4-slot and 8-slot models are provided that let you easily configure your system before implementing it into your application.

2.1 System Requirements

Before you start installing the ADAM-5510KW Series Controller, make sure the system requirements are met as below:

2.1.1 Host Computer Requirements

1. IBM PC compatible computer with Pentium II 350MHz processor.
2. Microsoft Windows 95/98/NT4.0 SP5/Windows 2000 SP2 or Windows XP.
3. At least 64 MB RAM.
4. 200 MB of hard disk space available
5. VGA 256 colors monitor, 800X600 resolution.
6. CD-ROM.
7. Mouse or other pointing devices.
8. At least one standard RS-232 port (e.g. COM1, COM2).

2.1.2 ADAM-5510KW Series Requirements

1. One ADAM-5510KW Series main unit, i.e., ADAM-5510KW, ADAM-5510EKW or ADAM-5510EKW/TP.
2. One ADAM-5510KW Series Startup Manual
3. One core clamp for power supply connection.
4. One Advantech Multiprog CD.
5. Power supply for ADAM-5510KW Series (+10 to +30 VDC unregulated)
6. One null modem cable with DB-9 connectors

2.1.3 I/O Module Requirements

At least one I/O module is needed to use the system. A variety of I/O modules are available to meet different application requirements. Table 2-1 gives a current listing of these modules for your reference. In following example, we will use ADAM-5051D in Slot 0 and ADAM-5056D in Slot 1 on ADAM-5510KW.

Module	Name	Specification	Reference
Analog I/O	ADAM-5013	3-ch. RTD input	Isolated
	ADAM-5017	8-ch. AI	Isolated
	ADAM-5017H	8-ch. High speed AI	Isolated
	ADAM-5018	7-ch. Thermocouple input	Isolated
	ADAM-5024	4-ch. AO	Isolated
Digital I/O	ADAM-5050	7-ch. D I/O	Non-isolated
	ADAM-5051	16-ch. DI	Non-isolated
	ADAM-5051D	16-ch. DI W/ LED	Non-isolated
	ADAM-5051S	16-ch. DI W/ LED	Isolated
	ADAM-5052	8-ch. DI	Isolated
	ADAM-5055S	8-ch. DI, 8-ch. DO W/ LED	Isolated
	ADAM-5056	16-ch. DO	Non-isolated
	ADAM-5056D	16-ch. DO W/LED	Non-isolated
	ADAM-5056S	16-ch. DO W/LED	Isolated
	ADAM-5056SO	16-ch. DO W/LED	Isolated
Relay Output	ADAM-5060	6-ch. Relay output	Isolated
	ADAM-5068	8-ch. Relay output	Isolated
	ADAM-5069	8-ch. Power Relay output	Isolated
Counter/Frequency	ADAM-5080	4-ch. Counter/Frequency	Isolated
Serial I/O	ADAM-5090	4-port RS-232	Non-isolated

Table 2-1 I/O Module Support List

Note: ADAM-5090 supports Communication Function Block only.

Chapter 2 Installation Guidelines

2.2 Hardware Installation

2.2.1 Selecting I/O Module

To organize an ADAM-5510KW Series Controller of data acquisition & control system, you need to select I/O modules to interface the main unit with field devices or processes that you have previously determined. There are several things should be considered when you select the I/O modules.

- What type of I/O signal is applied in your system?**
- How many I/O is required to your system?**
- How will you place the controller for concentrate the I/O points of an entire process?**
- What is the required voltage range for each I/O module?**
- What isolation environment is required for each I/O module?**
- What are the noise and distance limitations for each I/O module?**

Refer to Table 2-2 as I/O module selection guidelines

Choose this type of I/O module:	For these types of field devices or operations (examples):	Explanation:
Discrete input module and block I/O module	Selector switches, pushbuttons, photoelectric eyes, limit switches, circuit breakers, proximity switches, level switches, motor starter contacts, relay contacts, thumbwheel switches	Input modules sense ON/OFF or OPENED/CLOSED signals. Discrete signals can be either ac or dc.
Discrete output module and block I/O module	Alarms, control relays, fans, lights, horns, valves, motor starters, solenoids	Output module signals interface with ON/OFF or OPENED/CLOSED devices. Discrete signals can be either AC or DC.
Analog input module	Thermocouple signals, RTD signals, temperature transducers, pressure transducers, load cell transducers, humidity transducers, flow transducers, potentiometers.	Convert continuous analog signals into input values for ADAM-5510M
Analog output module	Analog valves, actuators, chart recorders, electric motor drives, analog meters	Interpret ADAM-5510M output to analog signals (generally through transducers) for field devices.

Table 2-2 I/O Selection Guidelines

Advantech provides 20 types of ADAM-5000 I/O modules for various applications so far. The Figure 2-1 and Table 2-3 will help you to select the ADAM-5000 I/O modules quickly and easily.

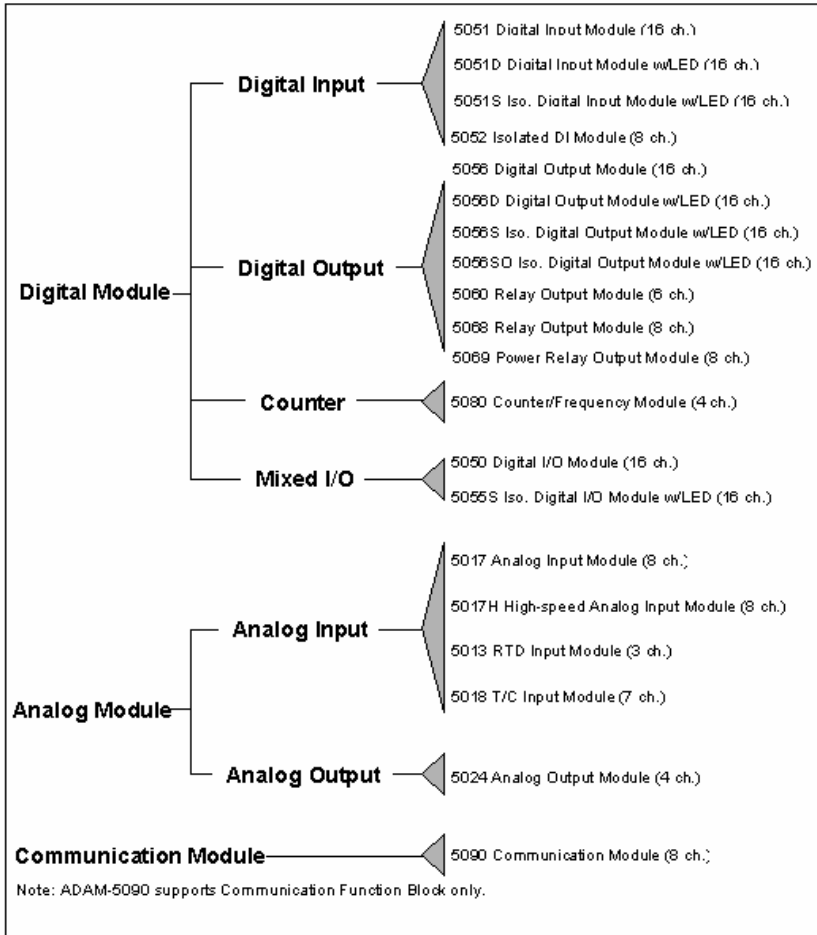

Figure 2-1 ADAM-5000 I/O Module Selection Chart

Chapter 2 Installation Guidelines

Module		ADAM-5013	ADAM-5017	ADAM-5017H	ADAM-5018	ADAM-5024
Analog Input	Resolution	16 bit	16 bit	12 bit	16 bit	-
	Input Channel	3	8	8	7	-
	Sampling Rate	10	10	8K	10	-
	Voltage Input	-	$\pm 150 \text{ mV} \pm 500 \text{ mV} \pm 1 \text{ V} \pm 5 \text{ V} \pm 10 \text{ V}$	$\pm 250 \text{ mV} \pm 500 \text{ mV} \pm 1 \text{ V} \pm 5 \text{ V} \pm 10 \text{ V}$	$\pm 15 \text{ mV} \pm 50 \text{ mV} \pm 100 \text{ mV} \pm 500 \text{ mV} \pm 1 \text{ V} \pm 2.5 \text{ V}$	-
	Current Input	-	$\pm 20 \text{ mA}^*$	$\pm 20 \text{ mA}^*$	$\pm 20 \text{ mA}^*$	-
Direct Sensor Input	Pt or Ni RTD	-	-	J, K, T, E, R, S, B	-	
Analog Output	Resolution	-	-	-	-	12 bit
	Voltage Output	-	-	-	-	0~10 V
	Current Output	-	-	-	-	0~20 mA 4~20 mA
Digital Input and Digital Output	Digital Input Channels	-	-	-	-	-
	Digital Output Channels	-	-	-	-	-
Count-er (32-bit)	Channels	-	-	-	-	-
	Input Frequency	-	-	-	-	-
	Mode	-	-	-	-	-
Isolation		3000 VDC	3000 VDC	3000 VDC	3000 VDC	3000 VDC

Module		ADAM-5050	ADAM-5051	ADAM-5051D	ADAM-5051S
Analog Input	Resolution	-	-	-	-
	Input Channel	-	-	-	-
	Sampling Rate	-	-	-	-
	Voltage Input	-	-	-	-
	Current Input	-	-	-	-
	Direct Sensor Input	-	-	-	-
Analog Output	Resolution	-	-	-	-
	Voltage Output	-	-	-	-
	Current Output	-	-	-	-
Digital Input and Digital Output	Digital Input Channels	16 DIO (bit-wise selectabl-e)	16	16 W/LED	16 W/LED
	Digital Output Channels		-	-	-
Count-er (32-bit)	Channels	-	-	-	-
	Input Frequency	-	-	-	-
	Mode	-	-	-	-
Isolation		-	-	-	2500 VDC

Chapter 2 Installation Guidelines

Module		ADAM-5052	ADAM-5055S	ADAM-5056	ADAM-5056D	ADAM-5056S /5056SO
Analog Input	Resolution	-	-	-	-	-
	Input Channel	-	-	-	-	-
	Sampling Rate	-	-	-	-	-
	Voltage Input	-	-	-	-	-
	Current Input	-	-	-	-	-
	Direct Sensor Input	-	-	-	-	-
Analog Output	Resolution	-	-	-	-	-
	Voltage Output	-	-	-	-	-
	Current Output	-	-	-	-	-
Digital Input and Digital Output	Digital Input Channels	8	8 W/LED	-	-	-
	Digital Output Channels	-	8 W/LED	16	16 W/LED	16 W/LED
Count-er (32-bit)	Channels	-	-	-	-	-
	Input Frequency	-	-	-	-	-
	Mode	-	-	-	-	-
Isolation		5000 VRMS	2500 VDC	-	-	2500 VDC

Module		ADAM-5060	ADAM-5068	ADAM-5069	ADAM-5080	ADAM-5090
Analog Input	Resolution	-	-	-	-	-
	Input Channel	-	-	-	-	-
	Sampling Rate	-	-	-	-	-
	Voltage Input	-	-	-	-	-
	Current Input	-	-	-	-	-
	Direct Sensor Input	-	-	-	-	-
Analog Output	Resolution	-	-	-	-	-
	Voltage Output	-	-	-	-	-
	Current Output	-	-	-	-	-
Digital Input and Digital Output	Digital Input Channels	-	-	-	-	-
	Digital Output Channels	6 relay (2 form A/ 4 form C)	8 relay (8 form A)	8 power relay (8 form A)	-	-
Counter (32-bit)	Channels	-	-	-	4	-
	Input Frequency	-	-	-	5000 Hz (max)	-
	Mode	-	-	-	Frequency, Up/Down Counter, Bi-direction Counter	-
RS-232	Channels	-	-	-	-	4
Isolation		-	-	-	1000 VRMS	-

Table 2-3 I/O Module Selection Tables

Chapter 2 Installation Guidelines

2.2.2 Selecting Power Supply Module

ADAM-5510KW Series Controller works under unregulated power source between +10 and +30 VDC. When you arrange different I/O modules on ADAM-5510KW Series Controller's backplane, it may require comparable power supply. Use the following steps as guidelines for selecting a power supply for your ADAM-5510KW Series control system.

Refer to Table 2-4 to check the power consumption of ADAM-5510KW Series Controller and each I/O module.

Main Units	Description	Power Consumption
ADAM-5000/485	Distributed Data Acquisition and Control System based on RS-485	1.0 W
ADAM-5000E	Distributed Data Acquisition and Control System based on RS-485	4.0 W
ADAM-5000/TCP	Distributed Data Acquisition and Control System based on Ethernet	5.0 W
ADAM-5510	PC-Based Programmable Controller (With Battery Backup)	1.0 W
ADAM-5510M	Enhanced PC-Based Programmable Controller (With Battery Backup)	1.2 W
ADAM-5511	PC-Based Programmable Controller with Modbus	1.0 W
ADAM-5510E	8-slot PC-Based Programmable Controller	1.2W
ADAM-5510/TCP	Ethernet-enabled PC-Based Programmable Controller	2.0W
ADAM-5510E/TCP	8-slot Ethernet-enabled PC-Based Programmable Controller	2.0W
ADAM-5510KW	PC-based SoftLogic Controller	1.2W
ADAM-5510EKW	8-slot PC-based SoftLogic Controller	1.2W
ADAM-5510EKW/TP	8-slot Ethernet-enabled SoftLogic Controller	2.0W
I/O Modules	Description	Power Consumption
ADAM-5013	3-Channel RTD Input Module	1.1 W
ADAM-5017	8-Channel Analog Input Module (mV, mA or High Voltage)	1.25 W
ADAM-5017H	8-Channel High speed Analog Input Module (mV, mA or High Voltage)	2.2 W
ADAM-5018	7-Channel Thermocouple Input Module (mV, V, mA, Thermocouple)	0.63 W
ADAM-5024	4-Channel Analog Output Module (V, mA)	2.9 W
ADAM-5050	16-Channel Universal DIO	1.2 W
ADAM-5051	16-Channel Digital Input Module	0.53 W
ADAM-5051D	16-Channel Digital Input w/LED Module	0.84 W
ADAM-5056S	16-Channel Isolated Digital Input w/LED Module	0.8 W
ADAM-5056SO	16-Channel Digital Input w/LED Module	0.84 W
ADAM-5052	8-Channel Isolated DI	0.27W
ADAM-5055S	16-Channel Isolated DIO w/LED Module	0.68 W
ADAM-5056	16-Channel Digital Output Module	0.53 W
ADAM-5056D	16-Channel Digital Output w/LED Module	0.84 W
ADAM-5056S	16-Channel Isolated Digital Output w/LED Module	0.6 W
ADAM-5060	6-Channel Relay Output Module (2 of Form A, 4 of Form C)	1.8 W
ADAM-5068	8-Channel Relay Output Module (8 Form A)	1.8 W
ADAM-5069	8-Channel Power Relay Output Module (8 Form A)	2.2W
ADAM-5080	4-Channel Counter/ Frequency Input Module	1.5 W
ADAM-5090	4-Channel RS-232 Communication Module	0.6W

Table 2-4 Power Consumption of ADAM-5000 series

Calculate the Summary of the whole system's power consumption. For example, there are following items in your system.

Chapter 2 Installation Guidelines

ADAM-5510KW * 3 & ADAM-5024 * 2 & ADAM-5017 * 4 &
ADAM-5068 * 2 & ADAM-5080 * 2

The power consumption is:

$$1.2W * 3 + 2.9W * 2 + 1.25 * 4 + 1.8W * 2 + 1.5W * 2 = 21W$$

Select a suitable power supply from Table 2-5 or other comparable power resource for system operation.

Specification	PWR-242	PWR-243	PWR-244
Input			
Input Voltage	90~264 V _{AC}	85~132 V _{AC} 170~264V _{AC}	100~240 V _{AC}
Input Frequency	47~63 Hz	47~63 Hz	47~63 Hz
Input Current	1.2 A max.	1.4 A max	25 A/110 V _{AC} 50A/220 V _{AC} (Inrush current)
Short Protection	Yes	Yes	Yes
Output			
Output Voltage	+24V _{DC}	+24V _{DC}	+24V _{DC}
Output Current	2.1 A	3 A	4.2 A
Overload Protection	Yes	Yes	Yes
General			
Dimension	181mm x 113 mm x 60 mm (L x W x H)	181mm x 113 mm x 60 mm (L x W x H)	181mm x 113 mm x 60 mm (L x W x H)
Operating Temperature	0~50°C (32~122°F)	0~50°C (32~122°F)	0~50°C (32~122°F)
DIN-rail Mountable	Yes	No	No

Table 2-5 Power Supply Specification Table

2.2.3 Install Main Unit and Modules

When inserting modules into the system, align the PC board of the module with the grooves on the top and bottom of the system. Push the module straight into the system until it is firmly seated in the backplane connector. Once the module is inserted into the system, push in the retaining clips (located at the top and bottom of the module) to firmly secure the module to the system.

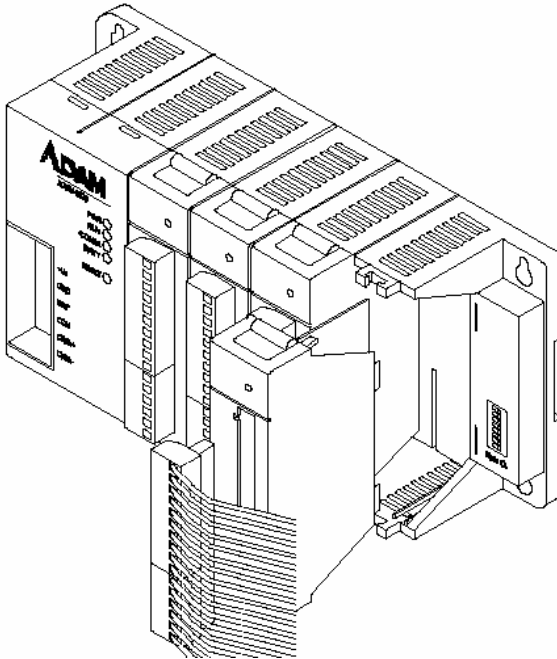

Figure 2-2 Module alignment and installation for 4-slot models (ADAM-5510KW)

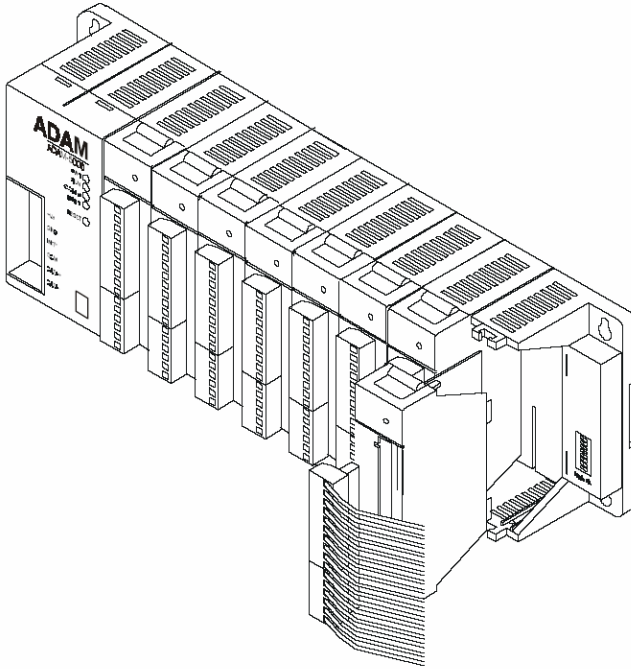

Figure 2-3 Module alignment and installation for 8-slot models (ADAM-5510EKW and ADAM-5510EKW/TP)

2.2.4 I/O Slots and I/O Channel Numbering

The ADAM-5510KW provides 4 slots for I/O modules. The I/O slots are numbered 0 through 3, and the channel numbering of any I/O module in any slot starts from 0. For example, the ADAM-5017 is an 8-channel analog input module. Its input channel numbering is 0 through 7.

Chapter 2 Installation Guidelines

2.2.5 Mounting

The ADAM-5510KW Series Controller can be installed on a panel or on a DIN rail.

Panel mounting

Mount the system on the panel horizontally to provide proper ventilation. You cannot mount the system vertically, upside down or on a flat horizontal surface. A standard #7 tapping screw (4 mm diameter) should be used.

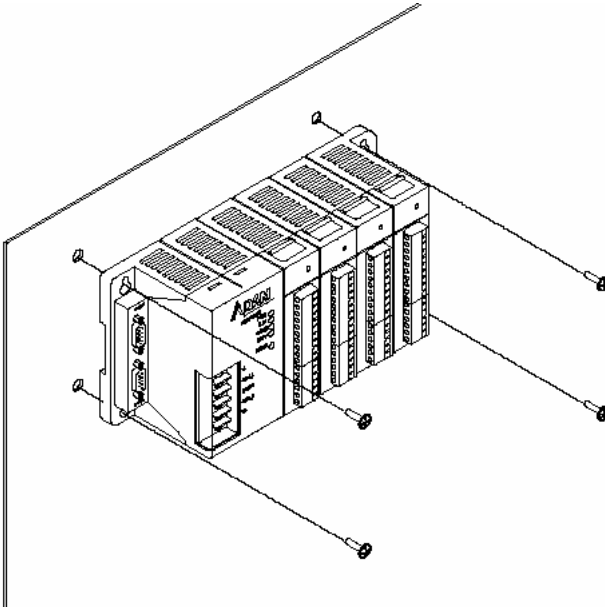

Figure 2-4: Panel mounting screw placement for (ADAM-5510KW)

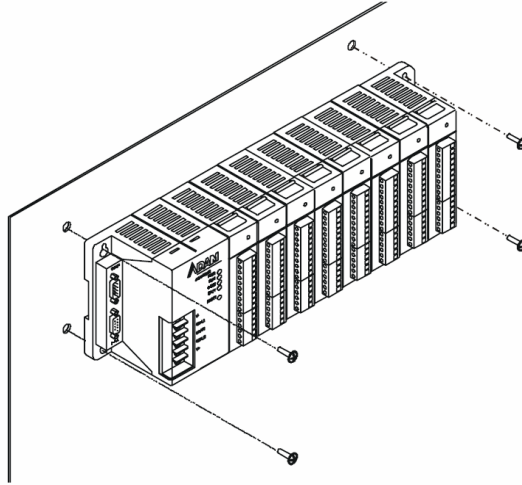

Figure 2-5: Panel mounting screw placement for 8-slot models (ADAM-5510EKW and ADAM-5510EKW/TP)

DIN rail mounting

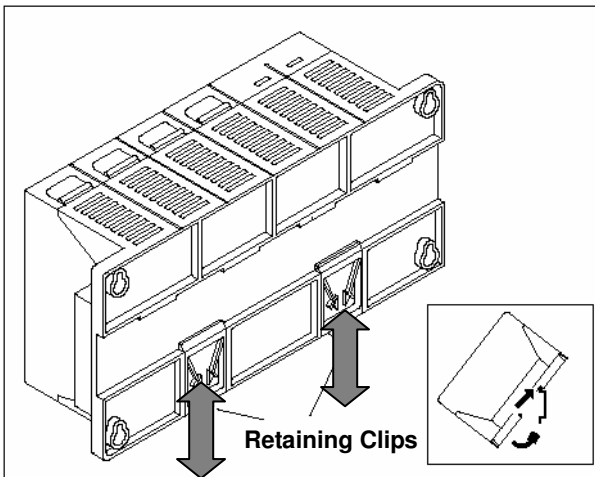
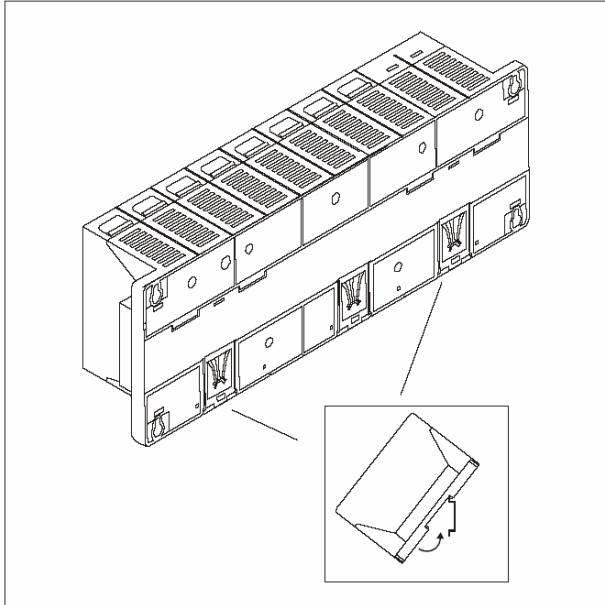

Figure 2-6: Rail mounting for 4-slot models (ADAM-5510KW)



**Figure 2-7: Rail mounting for 8-slot models
(ADAM-5510EKW and ADAM-5510EKW/TP)**

The system can also be secured to the cabinet by using mounting rails. If you mount the system on a rail, you should also consider using end brackets at each end of the rail. The ended brackets help keep the system from sliding horizontally along the rail. This minimizes the possibility of accidentally pulling the wiring loose. If you examine the bottom of the system, you will notice two small retaining clips. To secure the system to a DIN rail, place the system on to the rail and gently push up on the retaining clips. The clips lock the system on the rail. To remove the system, pull down on the retaining clips, lift up on the base slightly, and pull it away from the rail.

2.2.6 Jumper Settings and DIP Switch Settings

This section tells you how to set the jumpers and DIP switches to configure your ADAM-5510KW Series Controller. It gives the system default configuration and your options for each jumper and dip switch. There are three jumpers (JP2~JP4) on the CPU card, and one 8-pin DIP switch on backplane.

JP2 is for the watchdog timer setting
 JP3 is for COM2 port RS-485 setting (ADAM-5510KW and ADAM-5510EKW only.)
 JP4 is for battery power ON/OFF setting
 The following figure shows the location of the jumpers:

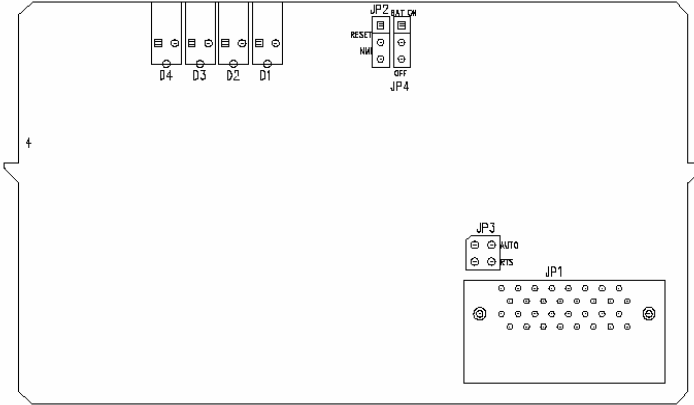

Figure 2-8: Jumper locations on the CPU card

2.2.6.1 COM2 port RS-485 control mode setting

The COM2 port is dedicated as an RS-485 interface. In an RS-485 network, handshaking signals such as RTS (Request to Send), normally control the direction of the data flow. A special I/O circuit in the ADAM-5510KW Series Controller CPU module senses the data flow direction and automatically switches the transmission direction, making handshaking signals unnecessary. Jumper JP3 gives users the option of configuring the COM2 port for automatic control or RTS control. Jumper settings are shown in Figure 2-5:

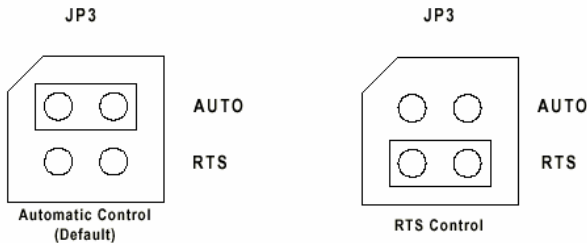

Figure 2-9: COM2 port RS-485 control mode setting (JP3)

Chapter 2 Installation Guidelines

Note: ADAM-5510EKW/TP module is set to Auto Mode by default and there is no more JP3 available.

2.2.6.2 Watchdog timer setting

Jumper JP2 on the CPU card lets you configure the watchdog timer to disable mode, reset mode or NMI (Non-maskable interrupt) mode. Jumper settings are shown below:

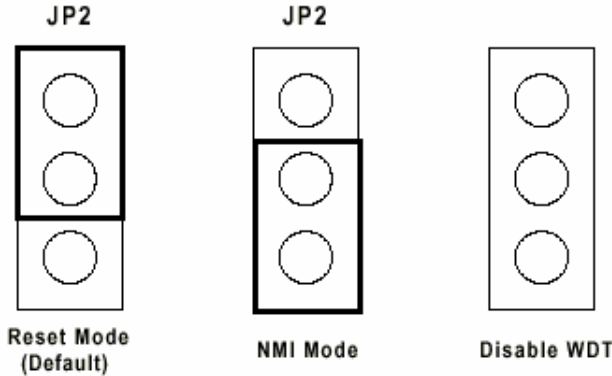

Figure 2-10: Watchdog timer setting

2.2.6.3 Battery backup setting

Jumper JP4 on CPU card lets you configure the battery backup for SRAM is ON or OFF. Jumper settings are shown below:

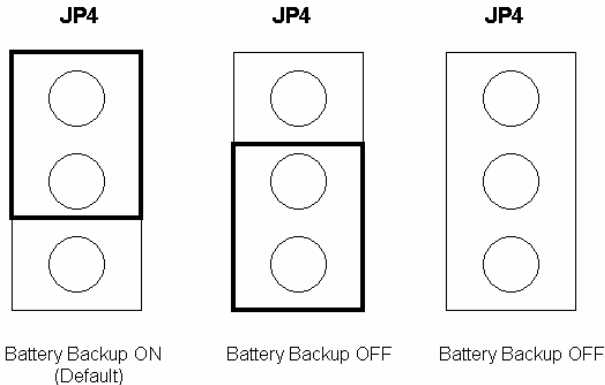

Figure 2-11: Watchdog timer setting

2.2.6.4 RS-232/485 selectable jumper setting

For ADAM-5510KW:

The Communication mode of COM4 is set by the Jumper 1 on the backplane. Please refer to Figure 2-12 to set the communication interface you prefer to.

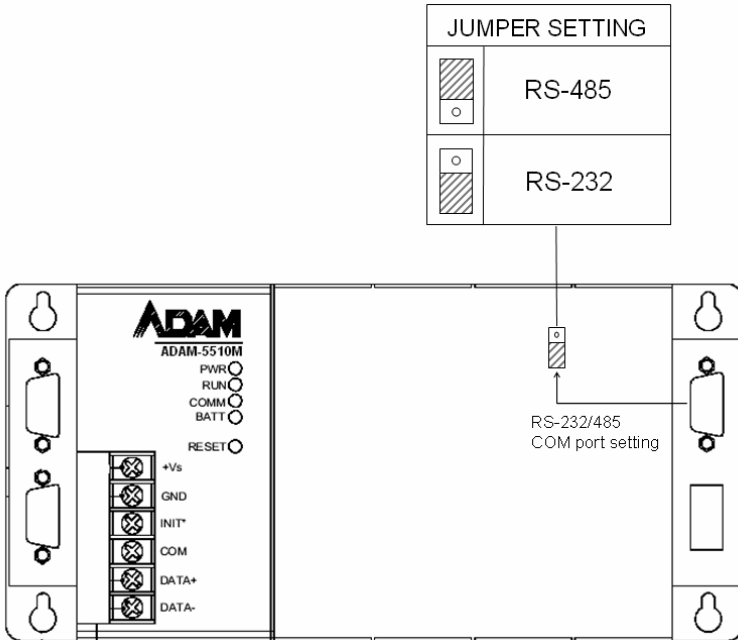

Figure 2-12 COM4 RS-232/485 Setting

For ADAM-5510EKW and ADAM-5510EKW/TP:

The Communication mode of COM1 and COM4 are set by JP3 and JP1 on the backplane. Please refer to Figure 2-13 to set the communication interface.

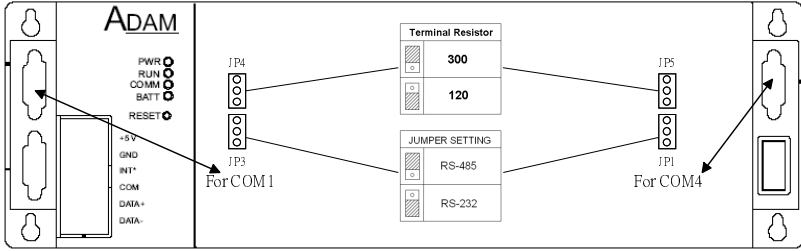

Figure 2-13 COM1/COM4 RS-232/485 Setting

2.2.6.5 DIP Switch Setting

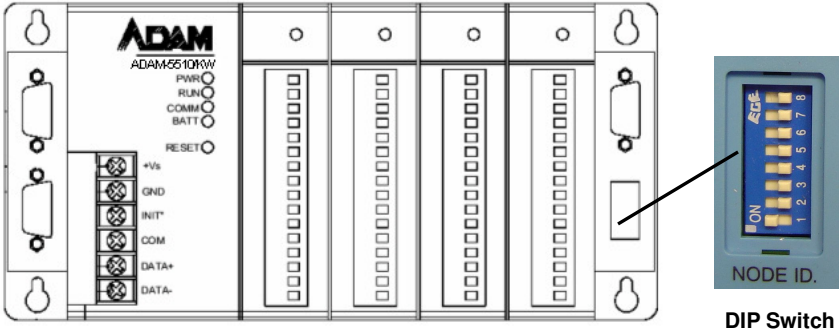

Figure 2-14: ADAM-5510KW Series Controller DIP Switch

DIP 1-5	DIP 6, 7,8
Device ID Setting	COM Port Selection and Mode Selection

Table 2-6 DIP Switch Function Table

Device ID Setting:

You can set up your device ID by changing DIP Switch 1-5. The available ID for ADAM-5510KW Series Controller is from 1 to 31. Please refer to the Fig 2.7 Device ID DIP Switch Table to set up your Device ID.

DIP 1	DIP 2	DIP 3	DIP 4	DIP 5	Device ID
On	Off	Off	Off	Off	1
Off	On	Off	Off	Off	2
On	On	Off	Off	Off	3
Off	Off	On	Off	Off	4
On	Off	On	Off	Off	5
Off	On	On	Off	Off	6
On	On	On	Off	Off	7
Off	Off	Off	On	Off	8
On	Off	Off	On	Off	9
Off	On	Off	On	Off	10
On	On	Off	On	Off	11
Off	Off	On	On	Off	12
On	Off	On	On	Off	13
Off	On	On	On	Off	14
On	On	On	On	Off	15
Off	Off	Off	Off	On	16
On	Off	Off	Off	On	17
Off	On	Off	Off	On	18
On	On	Off	Off	On	19
Off	Off	On	Off	On	20
On	Off	On	Off	On	21
Off	On	On	Off	On	22
On	On	On	Off	On	23
Off	Off	Off	On	On	24
On	Off	Off	On	On	25
Off	On	Off	On	On	26
On	On	Off	On	On	27
Off	Off	On	On	On	28
On	Off	On	On	On	29
Off	On	On	On	On	30
On	On	On	On	On	31

Table 2-7 Device ID DIP Switch Table

Note: DIP switch 0 is reserved by system configuration. Please leave this ID available.

Chapter 2 Installation Guidelines

DIP Switch of COM Port and Comm. Mode Selection:

SW6	COM Selection	SW7	SW8	Mode Selection / Baud Rate
ON	COM1/RS-232	ON	ON	Configuration Mode / 9600 bps
OFF	COM2/RS-485	ON	ON	Configuration Mode / 9600 bps
ON	COM1/RS-232	OFF	OFF	Modbus Protocol / 9600 bps
	COM2/RS-485			Multiprog Protocol / 19200 bps
OFF	COM2/RS-485	OFF	OFF	Modbus Mode / 9600 bps
	COM1/RS-232			Multiprog Protocol / 19200 bps
ON	COM1/RS-232	ON	OFF	Modbus Mode / 19200 bps
	COM2/RS-485			Multiprog Protocol / 19200 bps
OFF	COM2/RS-485	ON	OFF	Modbus Mode / 19200 bps
	COM1/RS-232			Multiprog Protocol / 19200 bps
ON	COM1/RS-232	OFF	ON	Modbus Mode / 38400 bps
	COM2/RS-485			Multiprog Protocol / 19200 bps
OFF	COM2/RS-485	OFF	ON	Modbus Mode / 38400 bps
	COM1/RS-232			Multiprog Protocol / 19200 bps

Table 2-8 Table of COM Port & Comm. Mode DIP Switch

Selecting COM port for configuration tool

You can swap the connection for configuration tool of I/O modules via COM1 or COM2 by following settings.

SW6	COM Selection	SW7	SW8	Mode Selection / Baud Rate
ON	COM1/RS-232	ON	ON	Configuration Mode / 9600 bps
OFF	COM2/RS-485	ON	ON	Configuration Mode / 9600 bps

Table 2-9 Table of COM Port For Configuration Tool

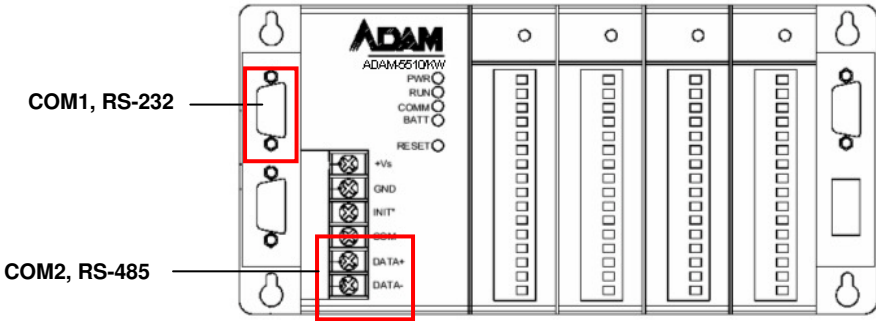

Figure 2-15: ADAM-5510KW Series COM1 and COM2

2.2.7 Pin assignment of COM port

Pin No.	Description
Pin 1	DCD
Pin 2	Rx
Pin 3	Tx
Pin 4	DTR
Pin 5	GND
Pin 6	DSR
Pin 7	RTS
Pin 8	CTS
Pin 9	RI

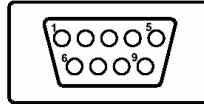

Table 2-10 RS-232 Port Pin Assignment

Pin No.	Description
Pin 1	DATA-
Pin 2	No Connection
Pin 3	No Connection
Pin 4	DATA+
Pin 5	No Connection
Pin 6	No Connection
Pin 7	No Connection
Pin 8	No Connection
Pin 9	No Connection

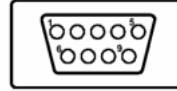

Table 2-11 RS-485 Port Pin Assignment

2.3 System Wiring and Connections

This section provides basic information on wiring the power supply, I/O modules and communication port connection.

2.3.1 Power supply wiring

Although the ADAM-5510KW Series Controller is designed for a standard industrial unregulated 24 V_{DC} power supply, they accept any power unit that supplies within the range of +10 to +30 V_{DC}. The power supply ripple must be limited to 200 mV peak-to-peak, and the immediate ripple voltage should be maintained between +10 and +30 V_{DC}. Screw terminals +Vs and GND are for power supply wiring.

Note: The wires used should be sized at least 2 mm.

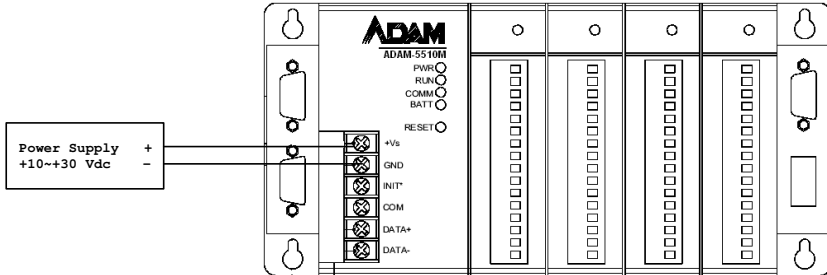

Figure 2-16: ADAM-5510KW Series Controller power wiring

2.3.2 I/O modules wiring

The system uses a plug-in screw terminal block for the interface between I/O modules and field devices. The following information must be considered when connecting electrical devices to I/O modules.

1. The terminal block accepts wires from 0.5 mm 2 to 2.5 mm.
2. Always use a continuous length of wire. Do not combine wires to make them longer.
3. Use the shortest possible wire length.
4. Use wire trays for routing where possible.
5. Avoid running wires near high energy wiring.
6. Avoid running input wiring in close proximity to output wiring where possible.
7. Avoid creating sharp bends in the wires.

2.3.3 Connection of Communication Ports

The ADAM-5510KW Series Controller has four communication ports. These ports allow you to program, configure, monitor, and integrate the remote devices.

2.3.3.1 MULTIPRO Programming Wiring

You can run the MULTIPROG from your Host PC and make some program or procedure in it and download the program to ADAM-5510KW Series Controller through COM1/RS-232 or COM2 RS-485 port. After the program has downloaded into system, ADAM-5510KW Series Controller will run the program automatically.

Chapter 2 Installation Guidelines

Multiprog via COM1/RS-232:

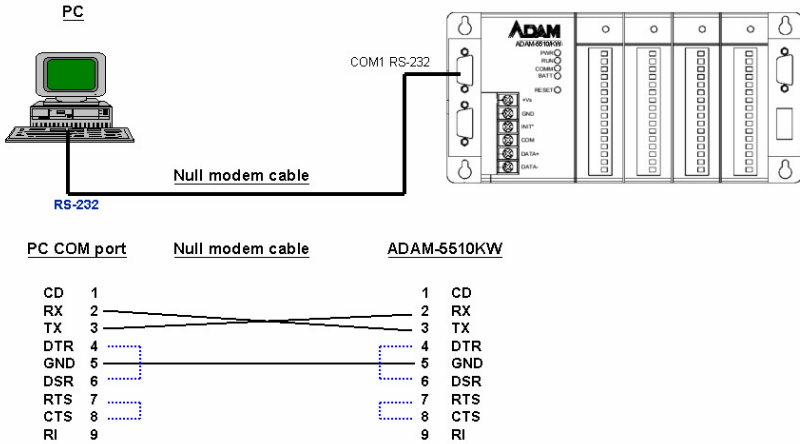

Figure 2-17: Multiprog Protocol via COM1

DIP Switch Setting:

SW6	COM Selection	SW7	SW8	Mode Selection / Baud Rate
OFF	COM1/RS-232	OFF	OFF	Multiprog Protocol / 19200 bps
OFF	COM1/RS-232	ON	OFF	Multiprog Protocol / 19200 bps
OFF	COM1/RS-232	OFF	ON	Multiprog Protocol / 19200 bps

Table 2-12 DIP Switch Setting for Multiprog Protocol via COM1

Note: The COM1 of ADAM-5510KW is dedicated as an RS-232 interface. However, the COM1 of ADAM-5510EKW and ADAM-5510EKW/TP is RS-232/RS-485 selectable. All models of ADAM-5510KW Series Controllers' COM4 is RS-232/485 selectable.

Multiprog via COM2/RS-485:

The ADAM-5510KW Series Controller COM2 is a dedicated RS-485 interface (Screw terminals DATA- and DATA+ are used for making the COM2 RS-485 connections). Usually, you will need to prepare an ADAM-4520 RS232/485 converter to link with host PC.

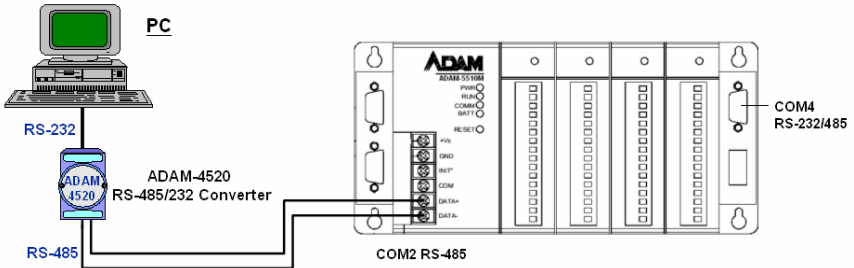

Figure 2-18: Multiprog Protocol via COM2

DIP Switch Setting:

SW6	COM Selection	SW7	SW8	Mode Selection / Baud Rate
ON	COM2/RS-485	OFF	OFF	Multiprog Protocol / 19200 bps
ON	COM2/RS-485	ON	OFF	Multiprog Protocol / 19200 bps
ON	COM2/RS-485	OFF	ON	Multiprog Protocol / 19200 bps

Table 2-13 DIP Switch Setting for Multiprog Protocol via COM2

2.3.3.2 Modbus/RTU Slave Wiring

HMI SCADA System Wiring

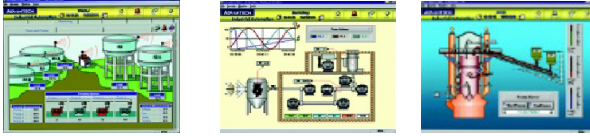

Modbus/RTU Slave via COM2:

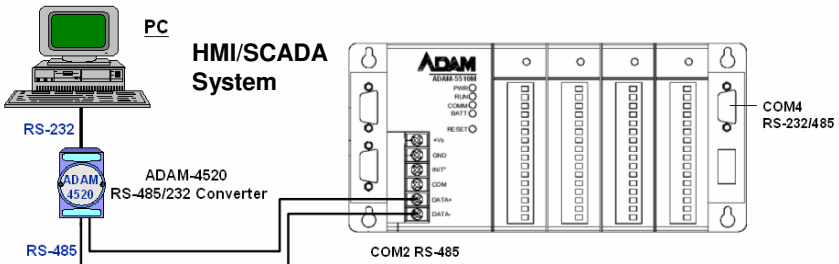

Figure 2-19: Modbus Protocol via COM2

DIP Switch Setting:

SW6	COM Selection	SW7	SW8	Mode Selection / Baud Rate
OFF	COM2/RS-485	OFF	OFF	Modbus Mode / 9600 bps
OFF	COM2/RS-485	ON	OFF	Modbus Mode / 19200 bps
OFF	COM2/RS-485	OFF	ON	Modbus Mode / 38400 bps

Table 2-14 DIP Switch Setting for Modbus Protocol via COM2

You can connect ADAM-5510KW Series Controller to the HMI SCADA System through MODBUS/RTU protocol via COM2 RS-485. If the HMI/SCADA doesn't include MODBUS/RTU OPC Server, you have to install an individual MODBUS/RTU OPC Server in your system such as ADAMView. If the MODBUS/RTU OPC Server is included such as

ASTUDIO, you can connect to ADAM-5510KW Series Controller directly.

Modbus/RTU Slave via COM1/RS-232:

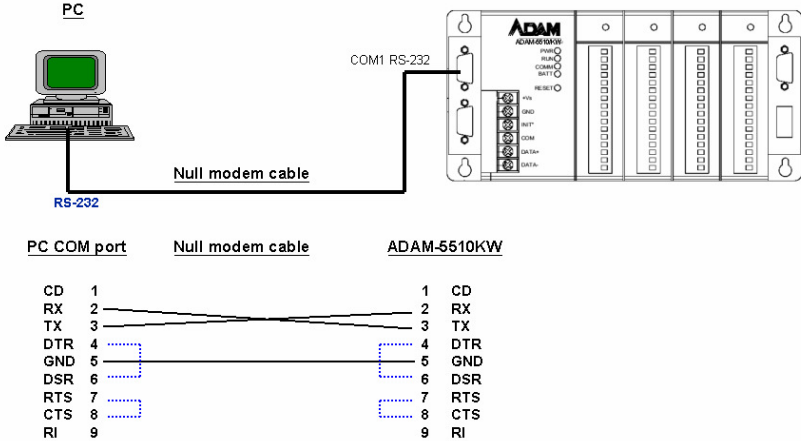

Figure 2-20: Modbus Protocol via COM1

DIP Switch setting:

SW6	COM Selection	SW7	SW8	Mode Selection / Baud Rate
ON	COM1/RS-232	OFF	OFF	Modbus Protocol / 9600 bps
ON	COM1/RS-232	ON	OFF	Modbus Mode / 19200 bps
ON	COM1/RS-232	OFF	ON	Modbus Mode / 38400 bps

Table 2-15 DIP Switch Setting for Modbus Protocol via COM1

2.3.3.3 Multi-connection Master/Slave Wiring

Modbus/RTU Slave via COM2 and Modbus/RTU Master via COM4/RS-485:

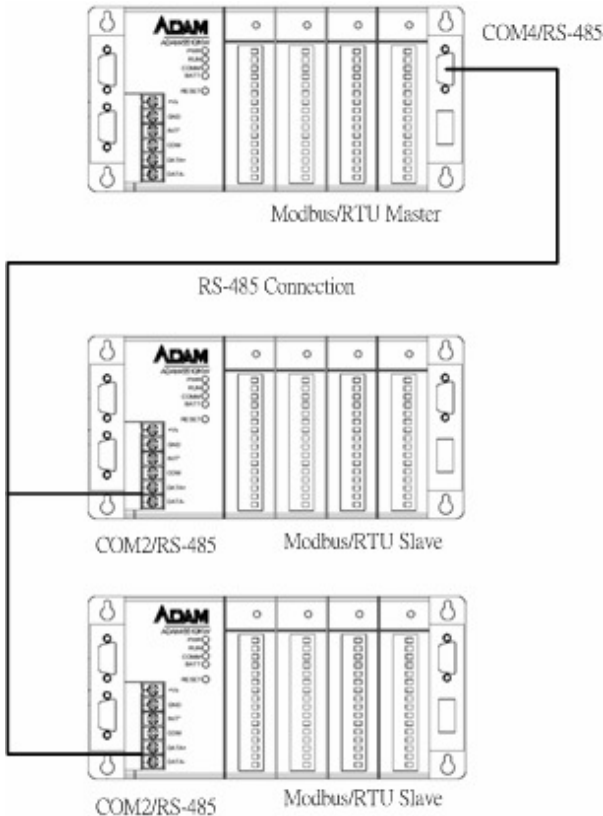

Figure 2-21: Multi-connection Master/Slave Wiring

COM4/RS-485 supports Modbus/RTU Master function. COM2 supports Modbus/RTU Slave function by the same DIP Switch setting as Table 2-14.

In multi-connection, you should adjust device ID by referring to Table 2-7 SW1 to SW5 of Device ID settings. Please note only one master device in the RS-485 network. The other devices should be set as slave mode.

2.3.3.4 Remote I/O Wiring

Modbus/RTU Master Function via COM4/RS-485:

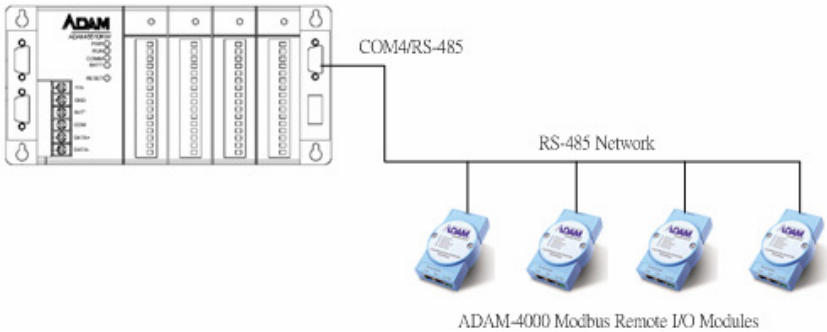

Figure 2-21: Multi-connection Master/Slave Wiring

You can connect typical 32 ADAM-4000 Modbus Remote I/O modules via COM 4. Please set the COM4 as RS-485 mode by Figure 2-12 and Figure 2-13.

Chapter 2 Installation Guidelines

2.3.3.5 Programming Port Wiring for Maintenance

The ADAM-5510KW Series Controller has a programming port (COM3) with a DB-9 connection. This port (COM3) allows you to program, configure, and troubleshoot the ADAM-5510KW from your host computer. It is necessary to use ADAM-5510 Series Controller Utility for debug the hardware of ADAM-5510KW Series Controller. The ADAM-5510 Series Controller can be found on Advantech Multiprog CD or download it from Advantech web site.

The programming port has an RS-232 interface and only uses TX, RX, and GND signals. The cable connection and the pin assignment are as follows:

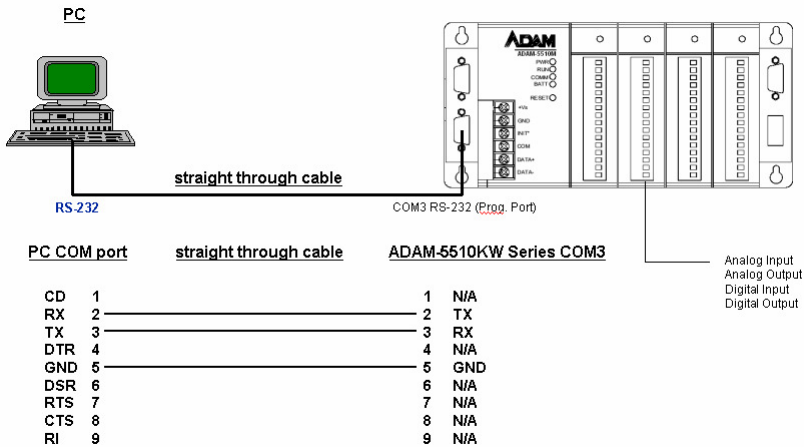

Figure 2-22: Programming Port Wiring

2.3.4 Ethernet Network Connection

The ADAM-5510EKW/TP provides Ethernet interface for network integration. Usually, you will need to prepare an ADAM-6520 Ethernet switch or hub for connecting to other network devices as following figure.

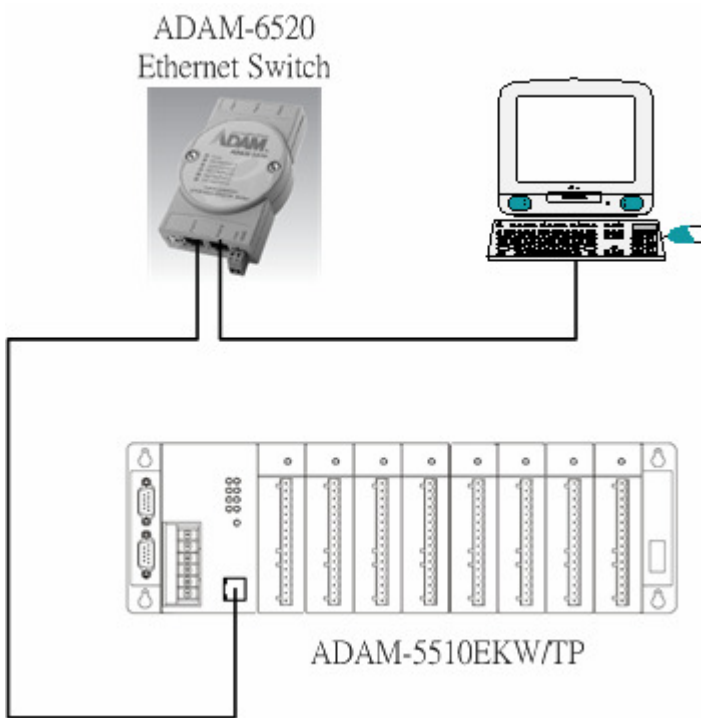

Figure 2-23: Ethernet Network Connection

3

Quick Start

Chapter 3 Quick Start

This chapter will help you get familiar with ADAM-5510KW Series Controller and Multiprog Programming Software by a simple example.

In following example, you need to prepare the system configuration as below.

Main Module:

ADAM-5510KW X1,
(Please note using ADAM-5510EKW or ADAM-5510EKW/TP will have the same test result in following example.)

I/O Module:

ADAM-5051D in Slot 0
ADAM-5056D in Slot 1

Advantech Multiprog CD:

Advantech Multiprog Software with license key.
ADAM-4000-5000 Utility

Power wiring

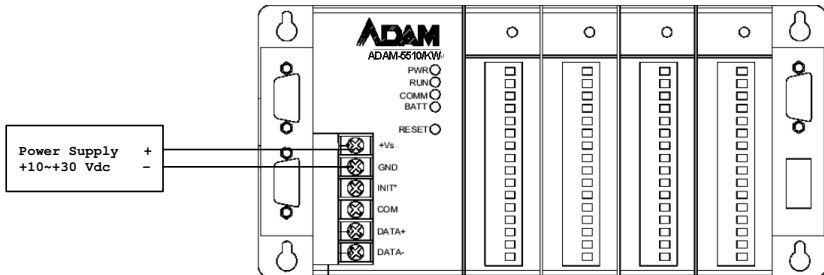

Communication Wiring

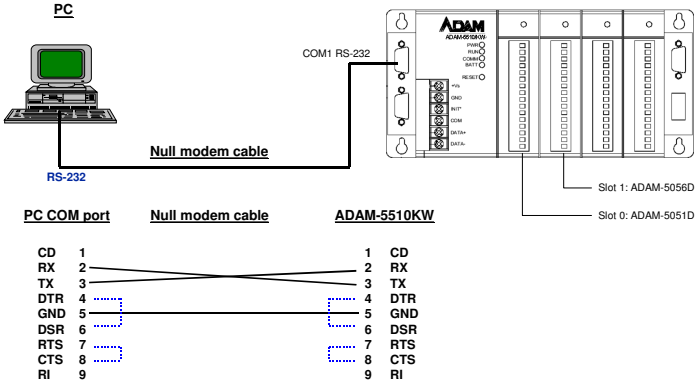

DIP Switch Settings

In following example, you need to set the DIP Switches as below.

ID Address: 1

Mode Selection: Configuration Mode

COM Port Selection: COM1/RS-232

DIP Switch of ID Address:

DIP	SW1	SW2	SW3	SW4	SW5
ON	1	2	4	8	16
OFF	0	0	0	0	0

ID Address = Value of (SW1+SW2+SW3+SW4+SW5)

Chapter 3 Quick Start

So we need to set SW1 to SW5 as below:

DIP	SW1	SW2	SW3	SW4	SW5
ON/OFF	ON	OFF	OFF	OFF	OFF

ID Address = 1+0+0+0+0 = 1

DIP Switch of COM Port and Mode Selection:

SW6	COM Selection	SW7	SW8	Mode Selection / Baud Rate
ON	COM1/RS-232	ON	ON	Configuration Mode / 9600 bps
OFF	COM2/RS-485	ON	ON	Configuration Mode / 9600 bps
ON	COM1/RS-232	OFF	OFF	Modbus Protocol / 9600 bps
	COM2/RS-485			Multiprog Protocol / 19200 bps
OFF	COM2/RS-485	OFF	OFF	Modbus Mode / 9600 bps
	COM1/RS-232			Multiprog Protocol / 19200 bps
ON	COM1/RS-232	ON	OFF	Modbus Mode / 19200 bps
	COM2/RS-485			Multiprog Protocol / 19200 bps
OFF	COM2/RS-485	ON	OFF	Modbus Mode / 19200 bps
	COM1/RS-232			Multiprog Protocol / 19200 bps
ON	COM1/RS-232	OFF	ON	Modbus Mode / 38400 bps
	COM2/RS-485			Multiprog Protocol / 19200 bps
OFF	COM2/RS-485	OFF	ON	Modbus Mode / 38400 bps
	COM1/RS-232			Multiprog Protocol / 19200 bps

So we need to set SW6 to SW8 as below:

SW6	COM Selection	SW7	SW8	Mode Selection / Baud Rate
ON	COM1/RS-232	ON	ON	Configuration Mode / 9600 bps

3.1 I/O Module Configuration

1. Insert the Advantech Multiprog CD and setup ADAM-4000-5000 Utility by running ADAM-4000-5000Utility.EXE under "ADAM-4000-5000" directory. If you cannot find the file, please download the ADAM-4000-5000 Series Utility from Advantech Support Site. (<http://www.advantech.com>)

2. Check the DIP Switch settings of ADAM-5510KW are set correctly and then reset ADAM-5510KW
3. Run ADAM-4000-5000 utility and search ADAM-5510KW

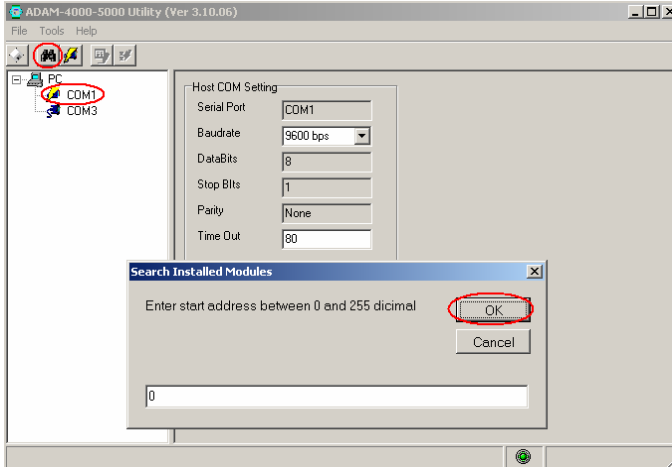

4. You will find ADAM-5510KW is searched as ADAM-5000. ADAM-5051 D is in Slot 0 and ADAM-5056D is in Slot 1. Also check DI0 status is ON. (Please note if you don't install other I/O modules in Slot 2 and Slot 3, you will only find ADAM-5051D and ADAM-5056D in the utility.)

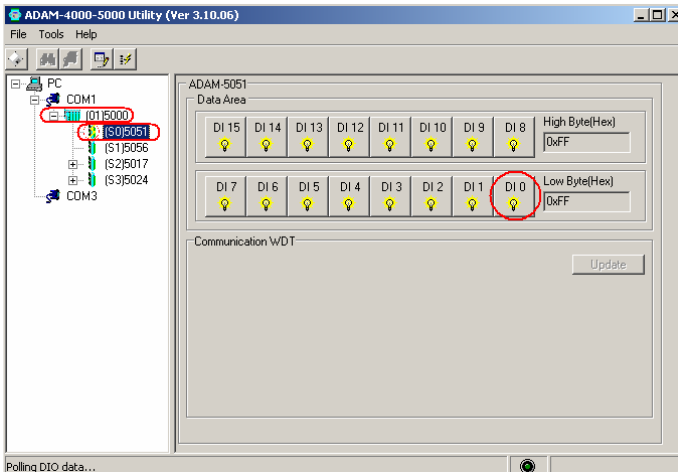

Chapter 3 Quick Start

5. Ground DI0 to power GND and check whether DI0 status is OFF in the utility.

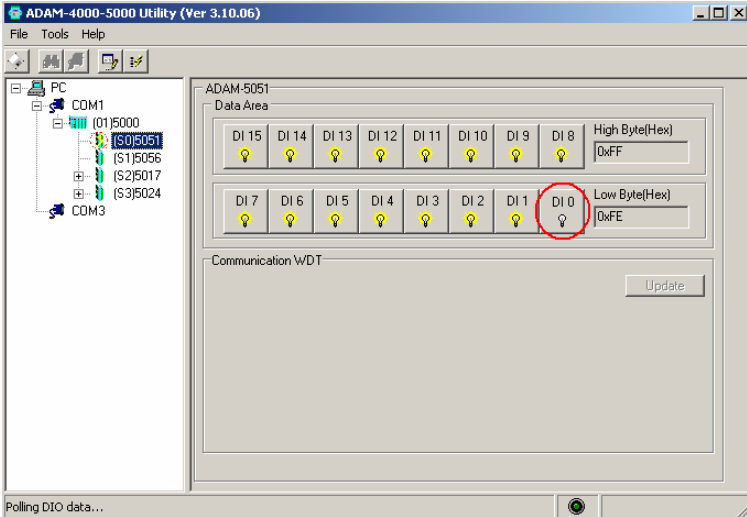

6. Click on ADAM-5056D module and check DI0 status is OFF.

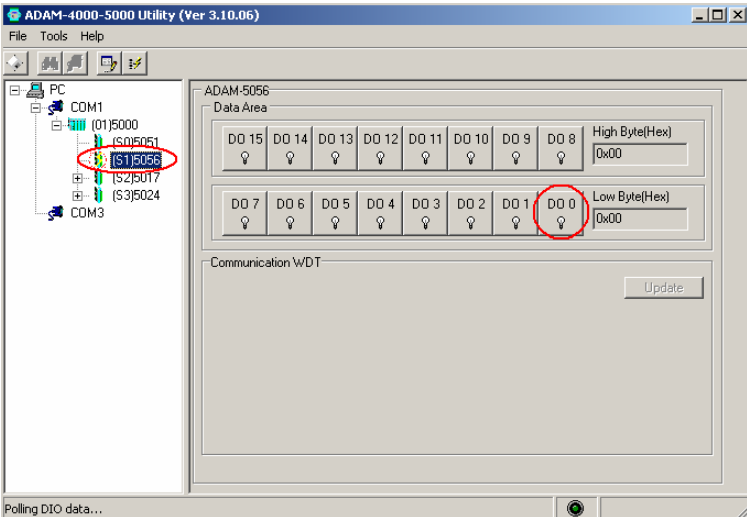

- Click on DO0 button and check the LED of ADAM-5056D DO0 is ON.

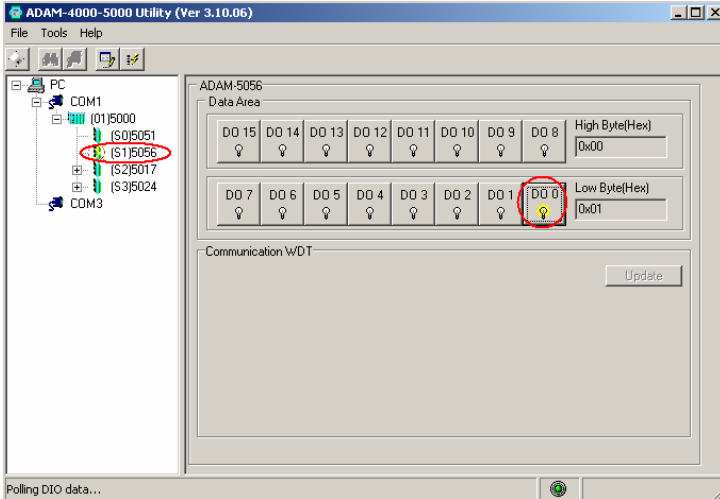

- Exit the utility and finish the I/O module configuration. You can make sure the hardware, which is used by this example, can work correctly now.

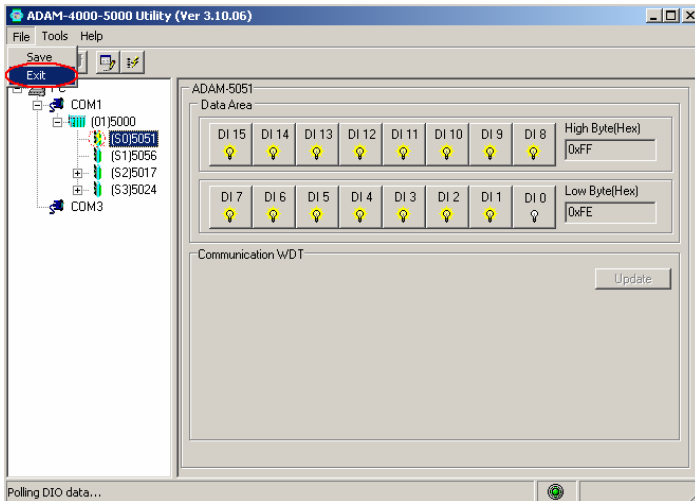

3.2 Software Installation

Following will demonstrate how to install Advantech Multiprog Software.

1. Insert the Advantech Multiprog CD and click Multiprog item.



2. Click "Next" button

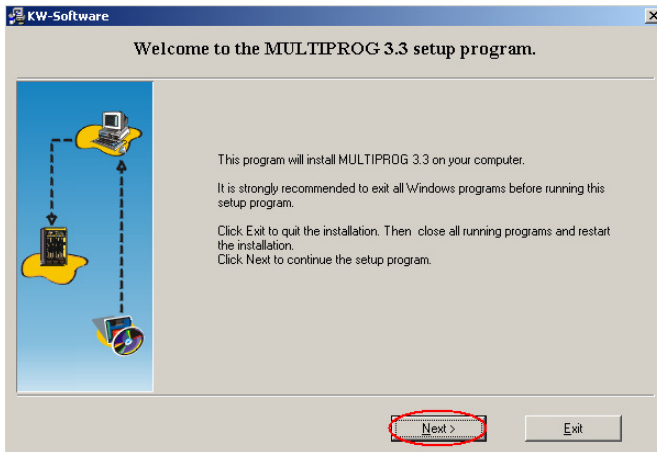

3. Select “I accept the item in the license agreement” and click “Next”

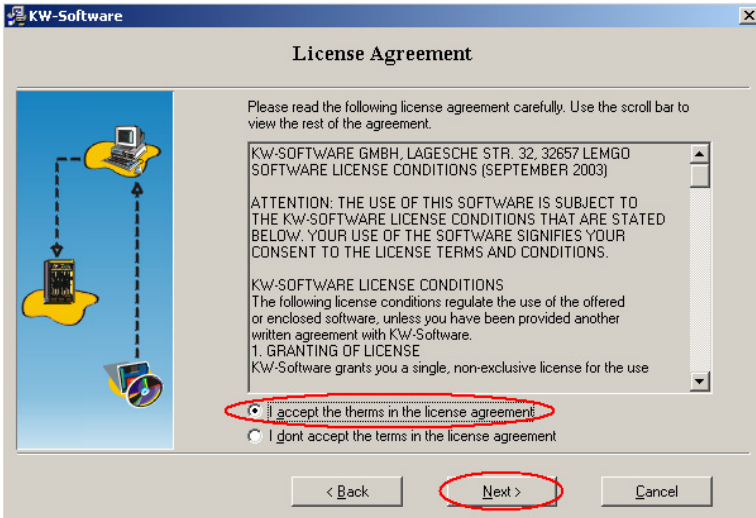

4. Select “English” only and click “Next”

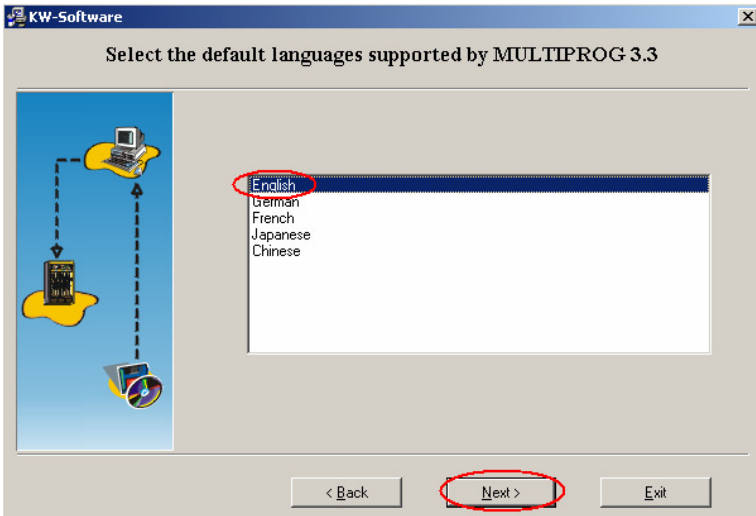

Chapter 3 Quick Start

5. Click “Next” for default directory to install Multiprog.

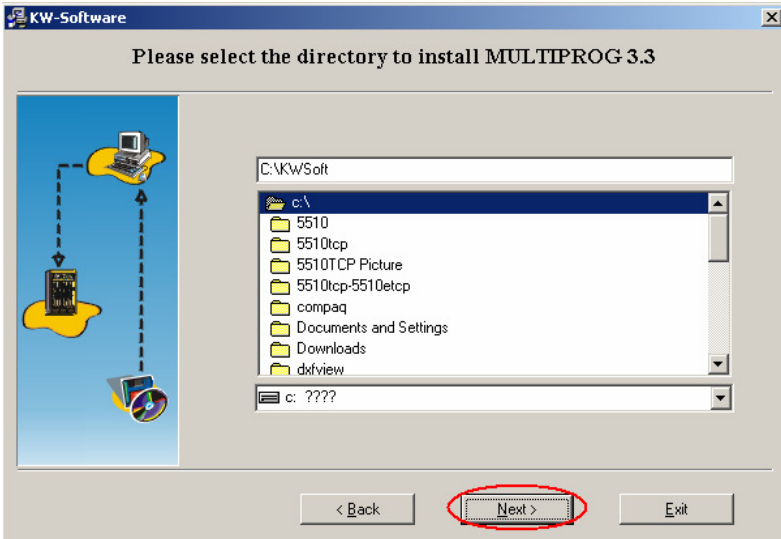

6. Click “Install” to start the installation.

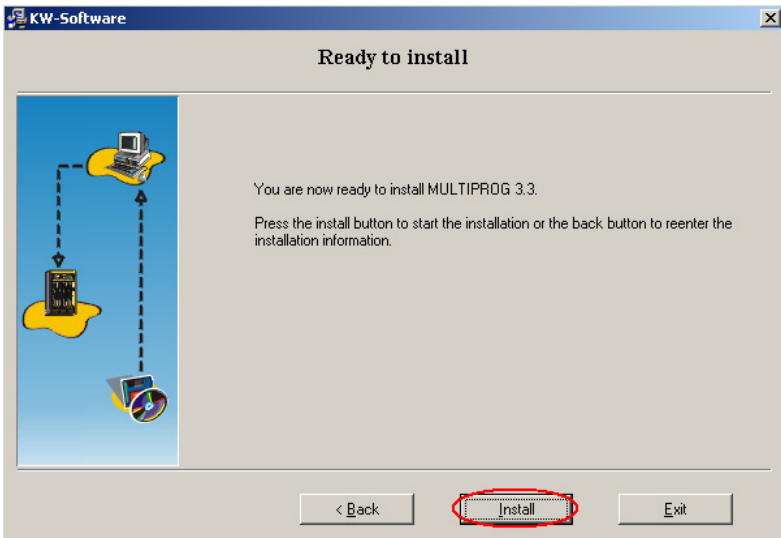

7. Click “OK” to finish the installation of Multiprog.

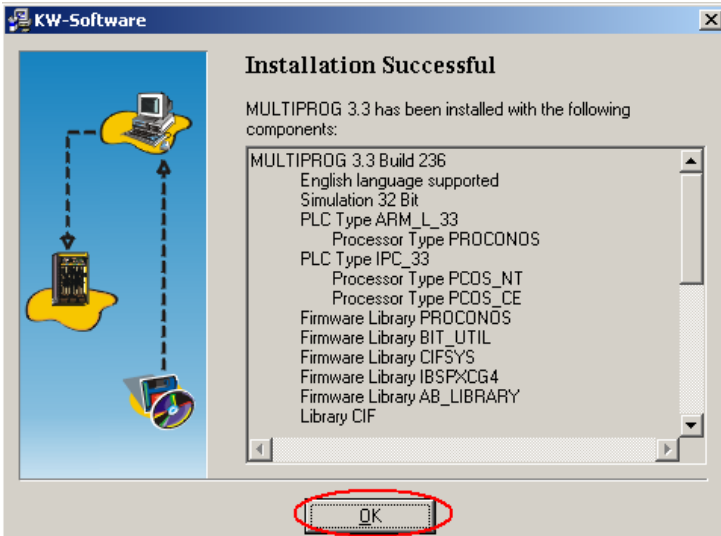

8. Click “Multiprog Add On”.



9. Click “Install Advantech Multiprog Add On”.

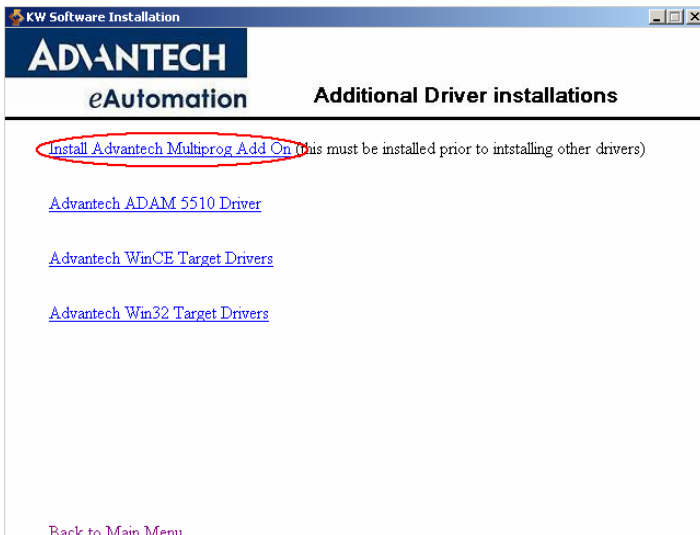

10. Click “Next”.

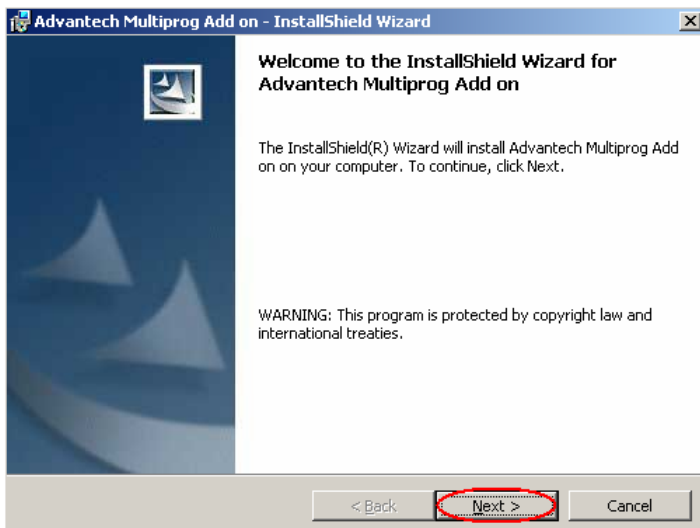

11. Select “I accept the item in the license agreement” and click “Next”.

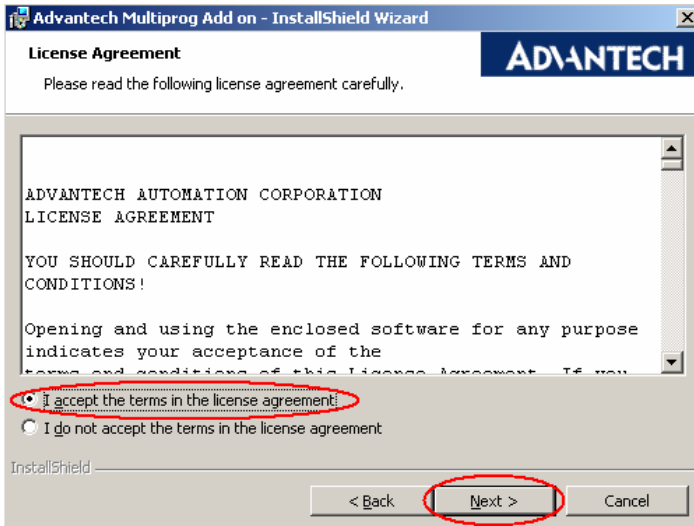

12. Click “Install”.

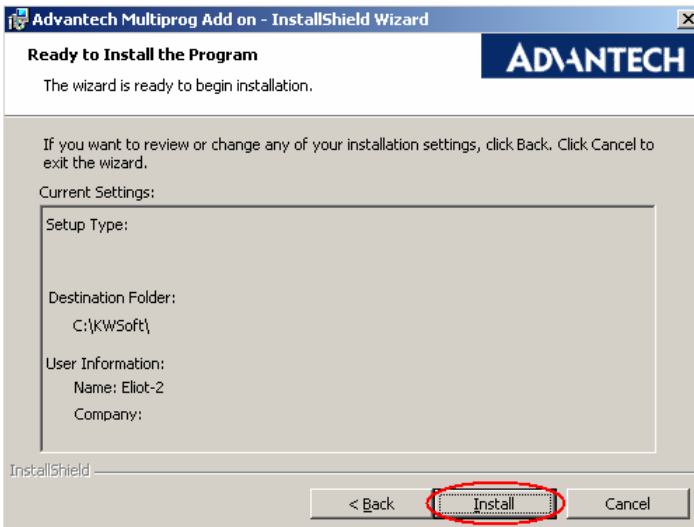

13. Click “EXIT” because “PLC Type IPC_32” is not necessary.



14. Click “Exit Setup”.

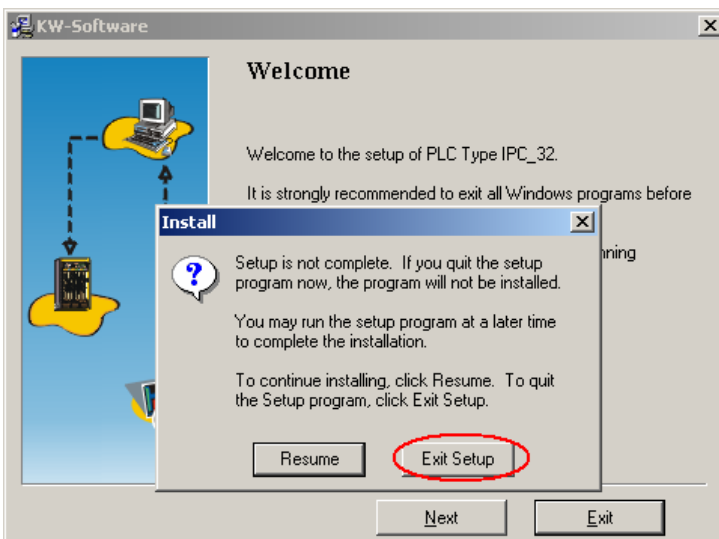

15. Click “EXIT” because “PLC Type ARM_L_32” is not necessary.

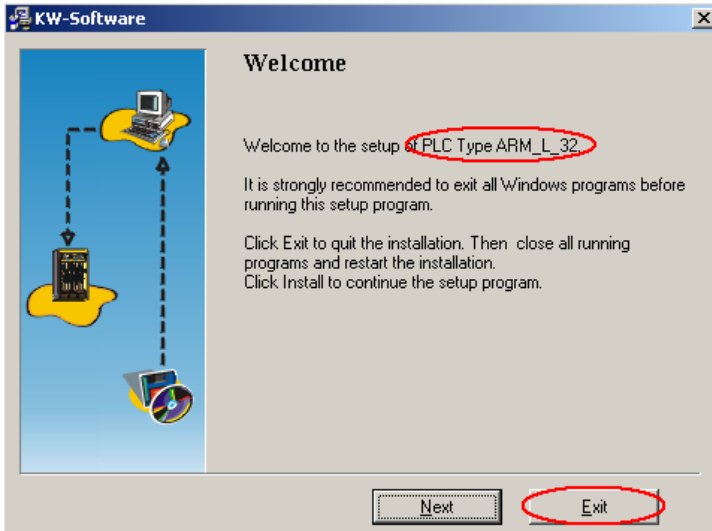

16. Click “Exit Setup”.

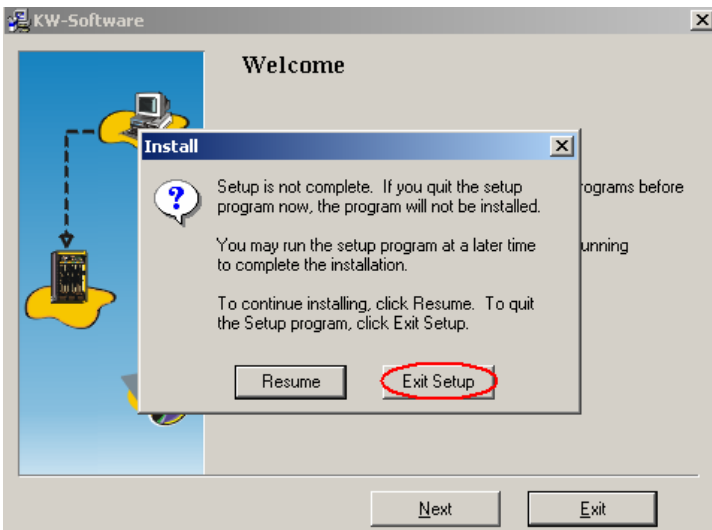

17. Click “Next” to install “PLC Type IPC_30”.

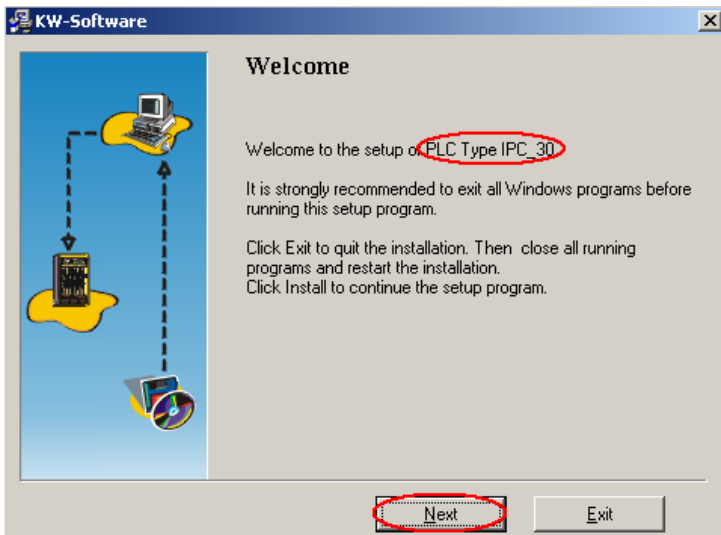

18. Click “Install”.

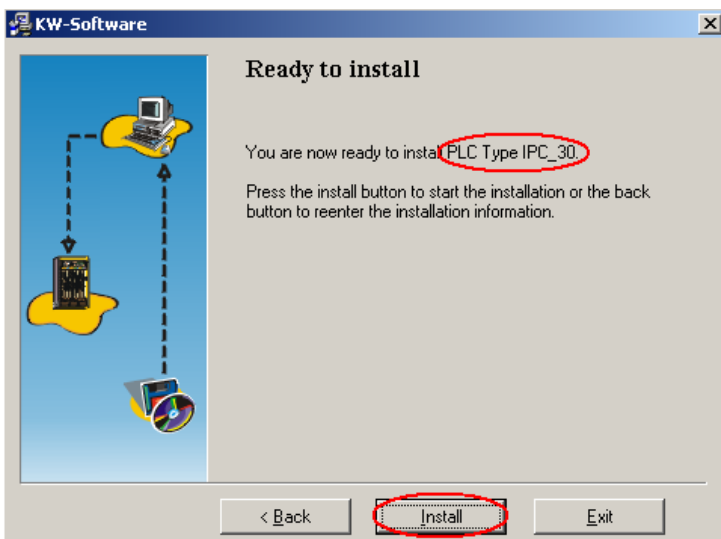

19. Click “Finish” to finish the installation.

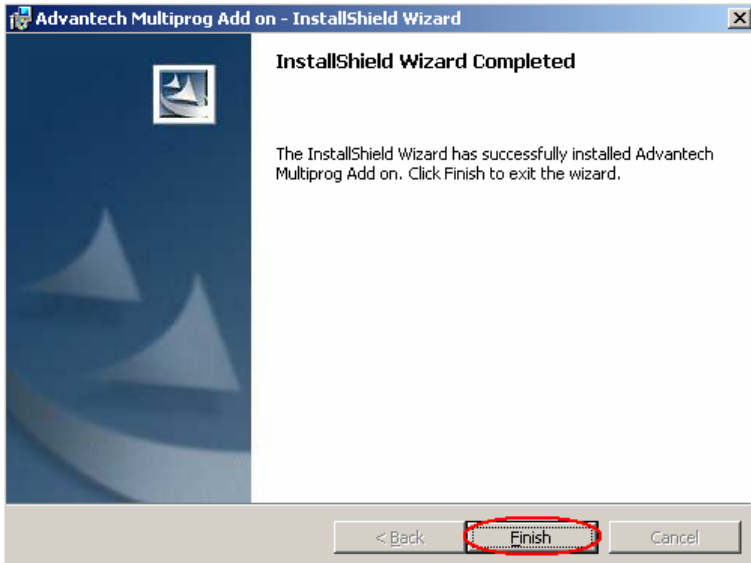

20. Click “Advantech ADAM-5510 Driver”.

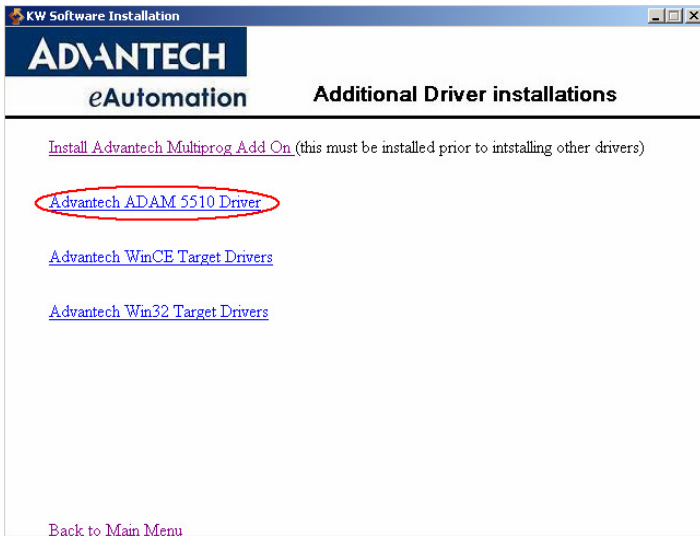

21. Click “Next”.

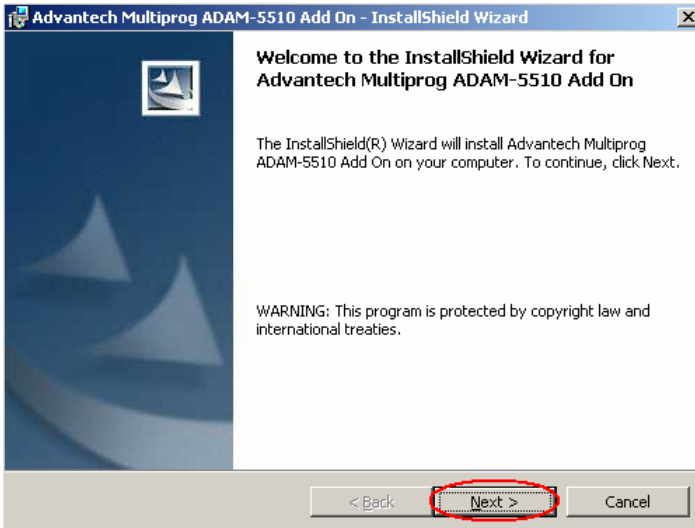

22. Select “I accept the item in the license agreement” and click “Next”.

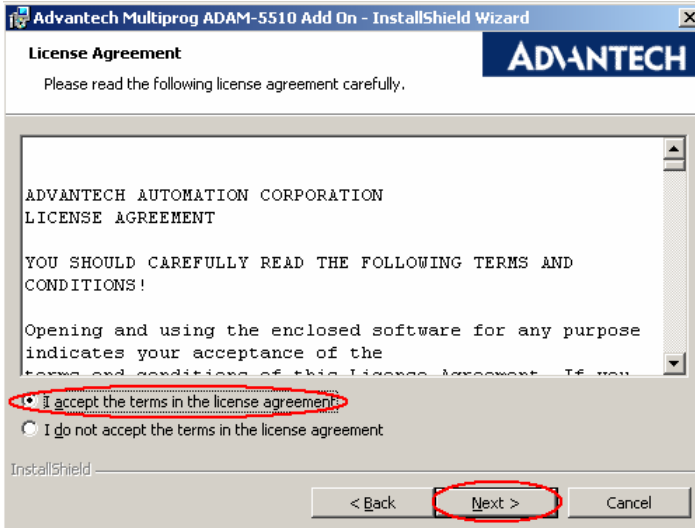

23. Click “Install”.

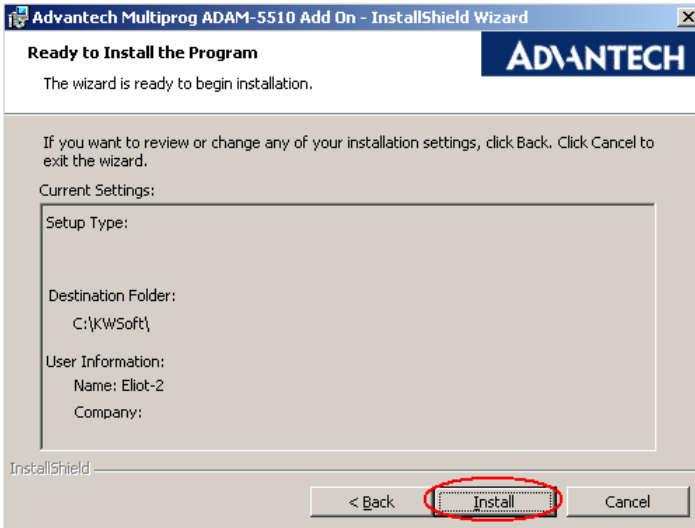

24. Click “Finish” to finish the installation.

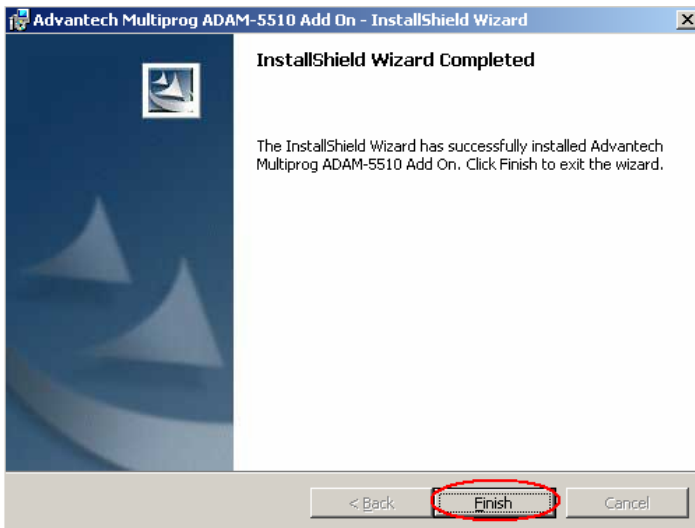

25. Click “Back to Main Menu”.

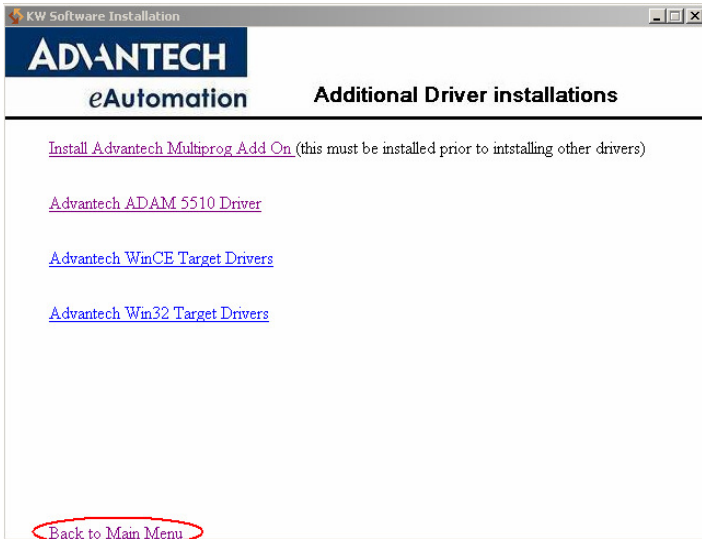

26. Click “Exit” to exit the installation page.



27. Change the DIP Switch settings as below and then reset the ADAM-5510KW.

SW6	COM Selection	SW7	SW8	Mode Selection / Baud Rate
OFF	COM2/RS-485	OFF	OFF	Modbus Mode / 9600 bps
	COM1/RS-232			Multiprog Protocol / 19200 bps

3.3 Create a Project and Test the System

In following demonstration, a simple project of performing DI and DO function by ladder diagram is shown. After finish this section, you can ensure the system is workable and also get familiar with Multiprog software.

1. Open Advantech Multiprog by clicking Multiprog item.

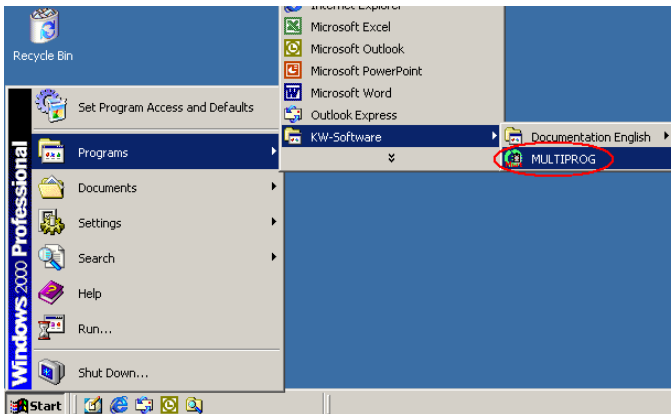

Chapter 3 Quick Start

2. Click “OK” to enter the DEMO Mode.

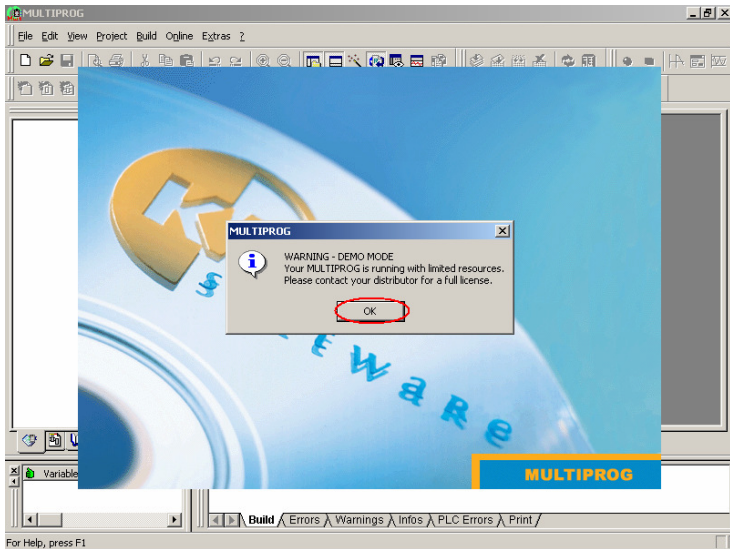

3. Click “Register” to enter the Registration Code.

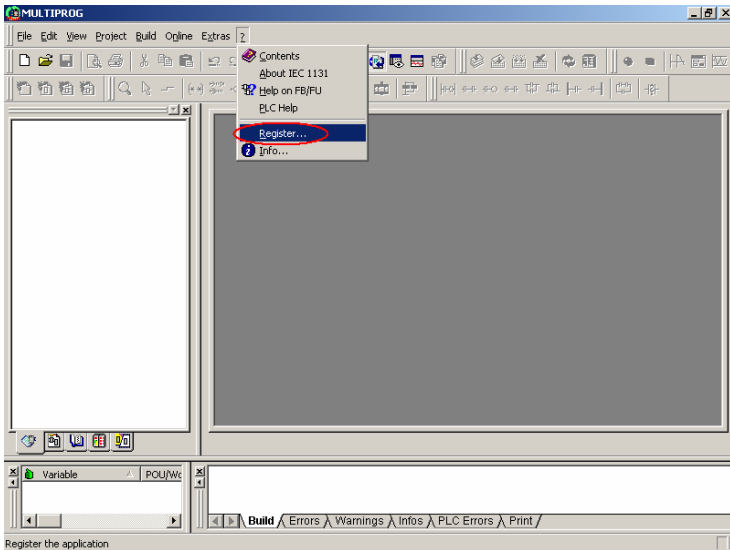

4. Enter the Registration Code which comes with Advantech Multiprog Software License Sheet.

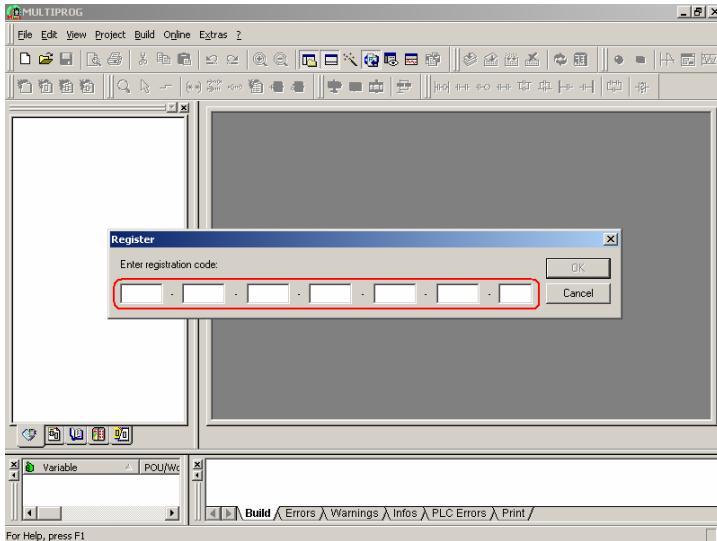

5. Click "OK" to finish the registration.

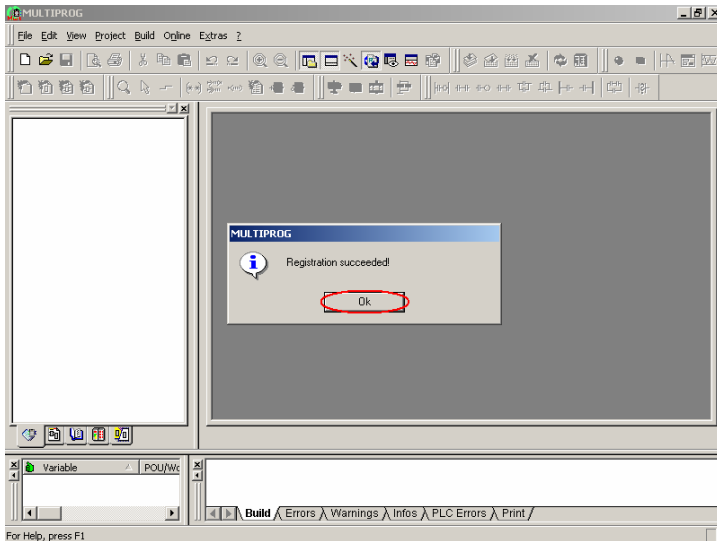

Chapter 3 Quick Start

6. Open a new project and start to create the test project.

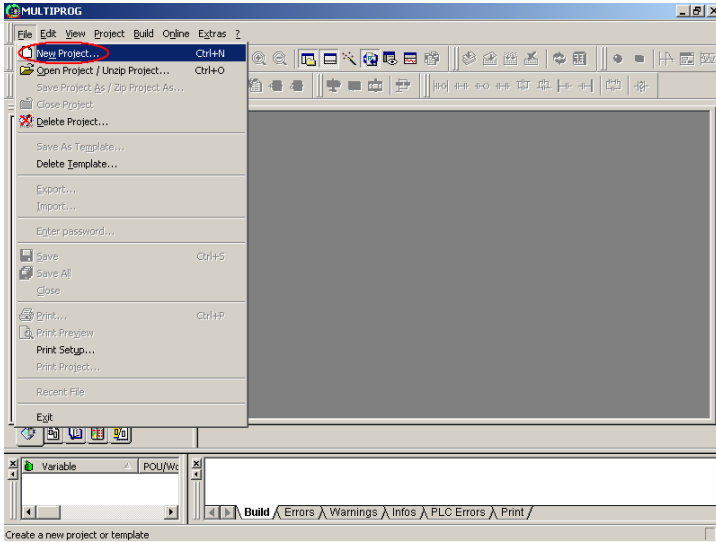

7. Select "Advantech ADAM-5510" item and then click "OK".

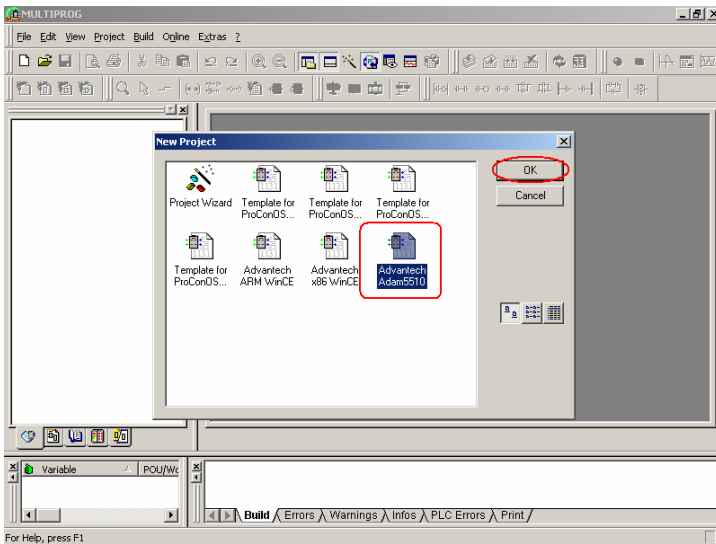

8. Right click “Resource” and select “Settings” item.

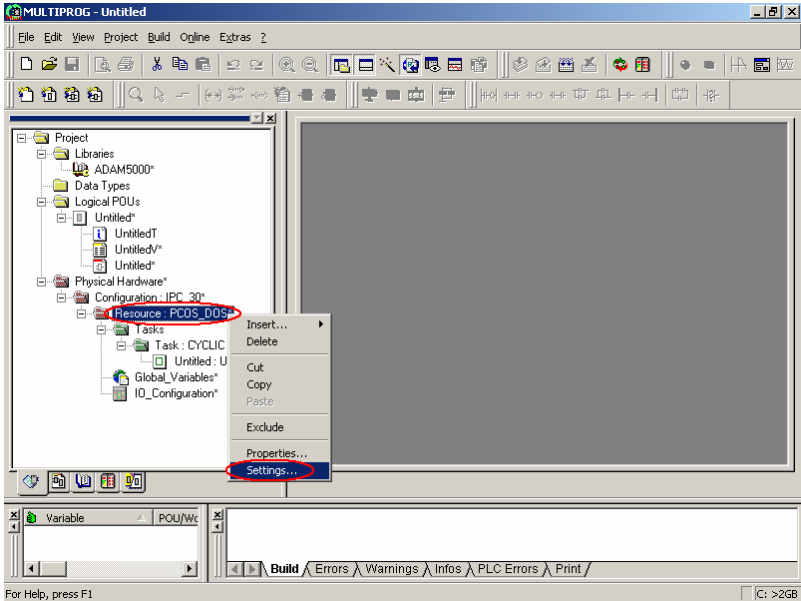

9. Change the COM Port settings as below and click “Data Area”.

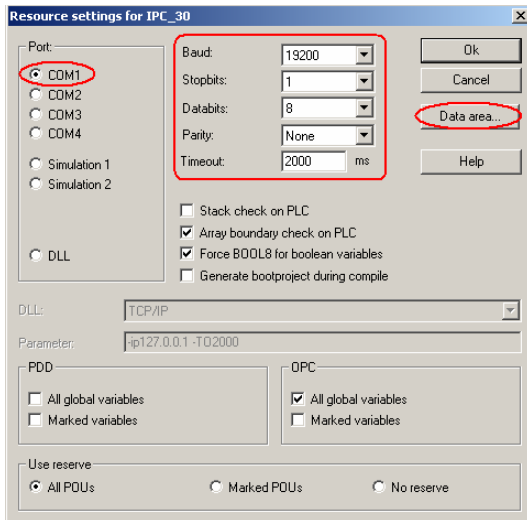

Chapter 3 Quick Start

10. Change the memory settings as below and click “OK”.

Section	Parameter	Value
Non retain	Start user:	0
	End user / Start system:	0
	End system (max 63999):	63999
	Reserve per PDU:	500
Retain	Start user:	64000
	End user / Start system:	64000
	End system (max 65530):	65530
	Reserve per PDU:	10%

Declare user memory automatically

11. Right click “IO_Configuration” and select “Open Worksheet” item.

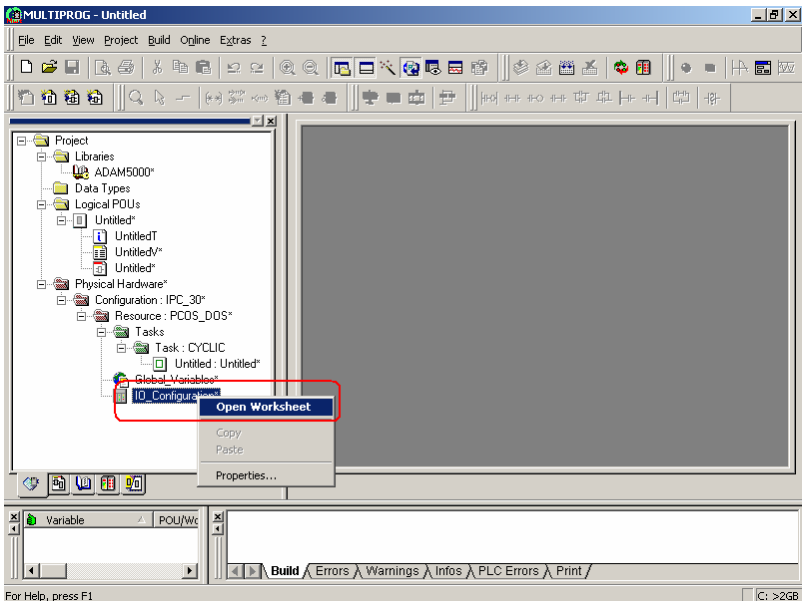

12. Click “Delete” and remove the “in” item.

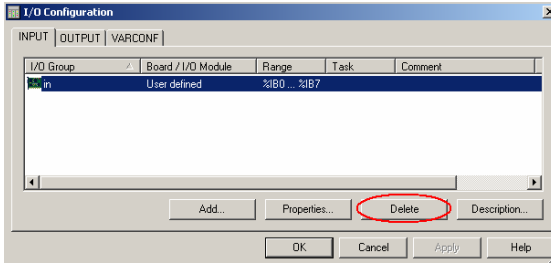

13. Click “Add” to add ADAM-5051D DIO.

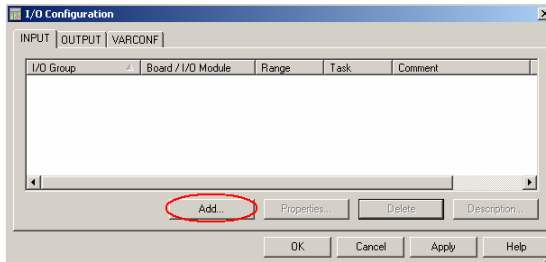

14. Fill in the “Name” and “Logical Addresses”. Select ADAM-5510KW and then click “Driver Parameter”.

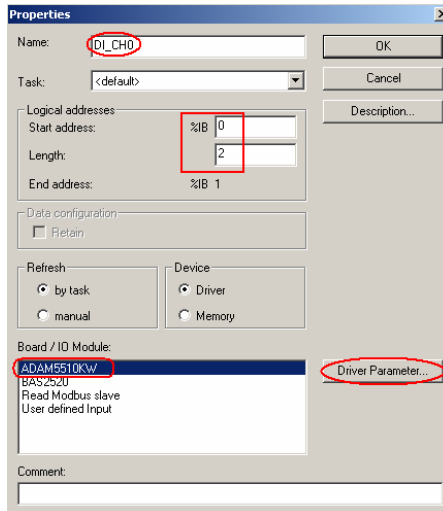

Chapter 3 Quick Start

15. Select “Slot” and “Module name” as below and then click “Serial port setup”.

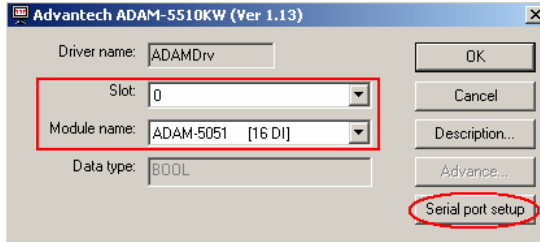

16. Select “NOPARITY,8,1” item and click “OK”.

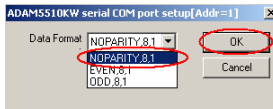

17. Click “Apply” to finish the configuration of ADAM-5051D DI0.

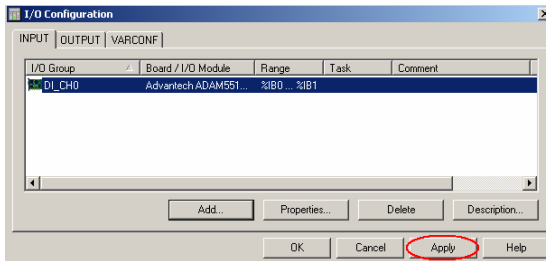

18. Click “Delete” and remove the “out” item.

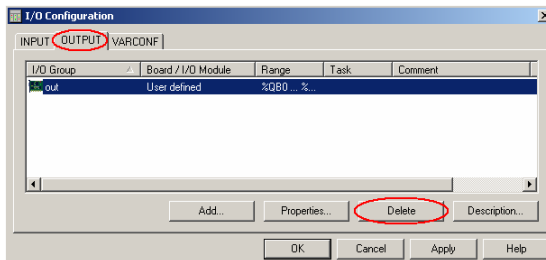

19. Click “Add” to add ADAM-5056D DO0.

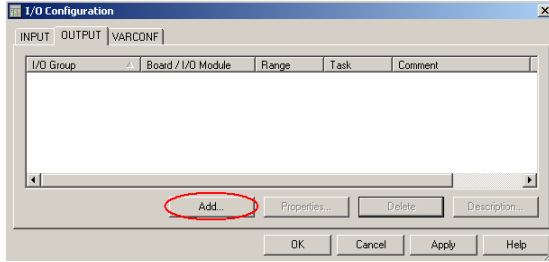

20. Fill in the “Name” and “Logical Addresses”. Select ADAM-5510KW and then click “Driver Parameter”.

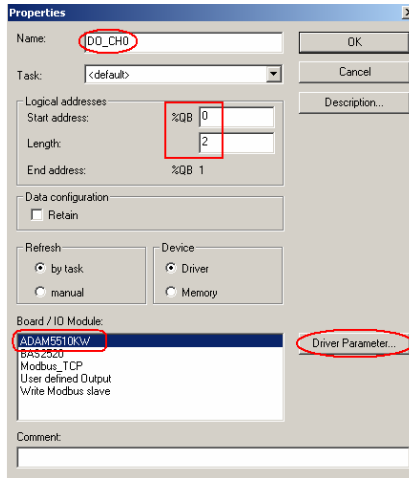

21. Select “Slot” and “Module name” as below and then click “Serial port setup”.

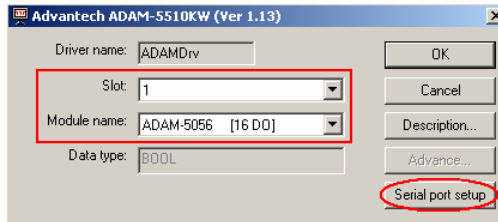

22. Select “NOPARITY,8,1” item and click “OK”.

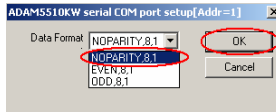

23. Click “Apply” and “OK” to finish the configuration of ADAM-5056D DO0.

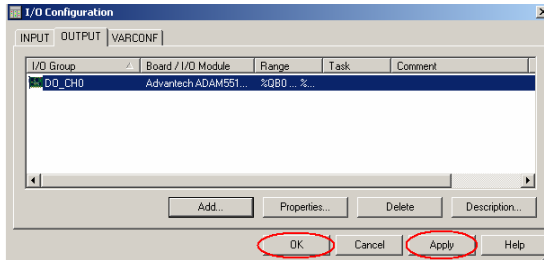

24. Click the “Untitled” item” as below and you will see following function block on the graphic editor. The graphic editor is a window where you can develop your PLC program.

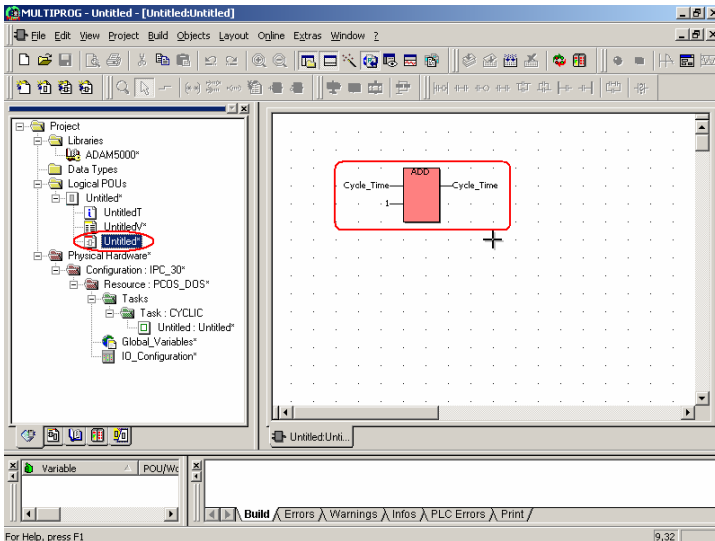

25. Right click “UntitledV” and select “Open Worksheet”.

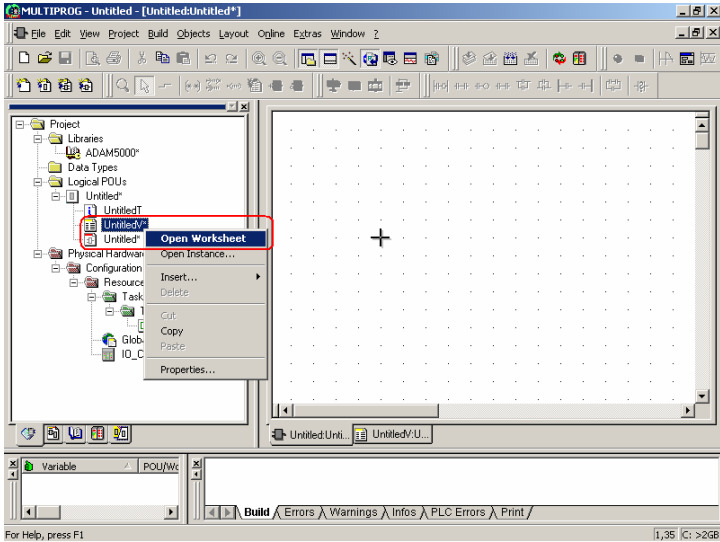

26. Select the row of “Cycle_Time” and press delete key to delete it from the Variable Grid Worksheet..

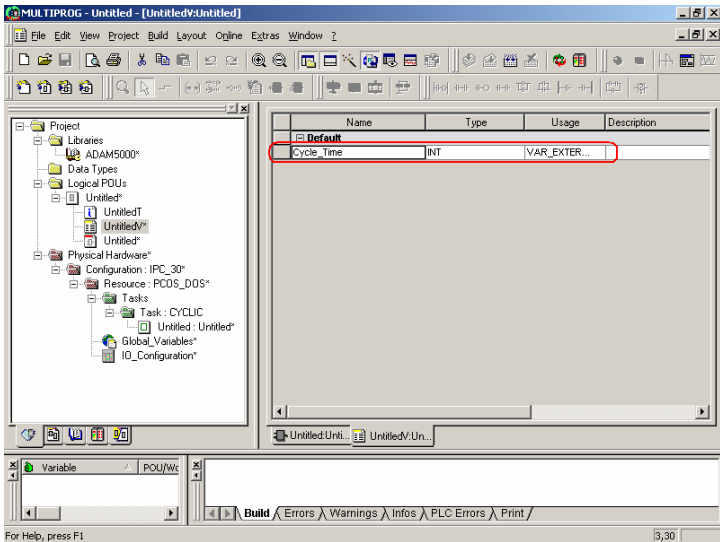

27. You will see all the variables are removed from the Variable Grid Worksheet.

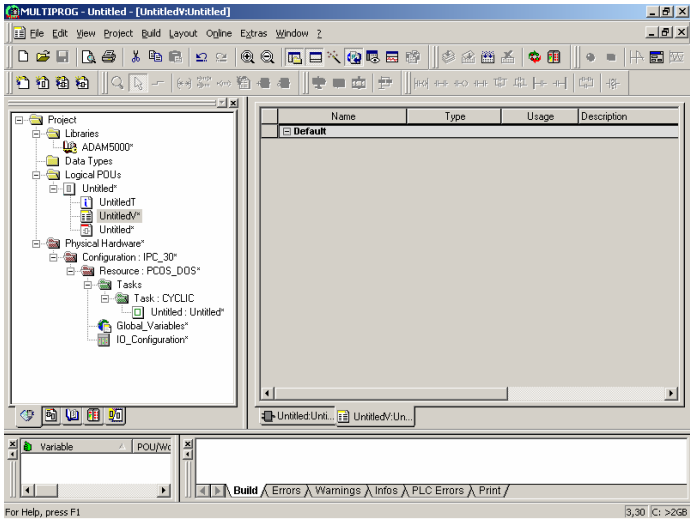

28. Switch the screen to Graphical Editor and add a contact network as below.

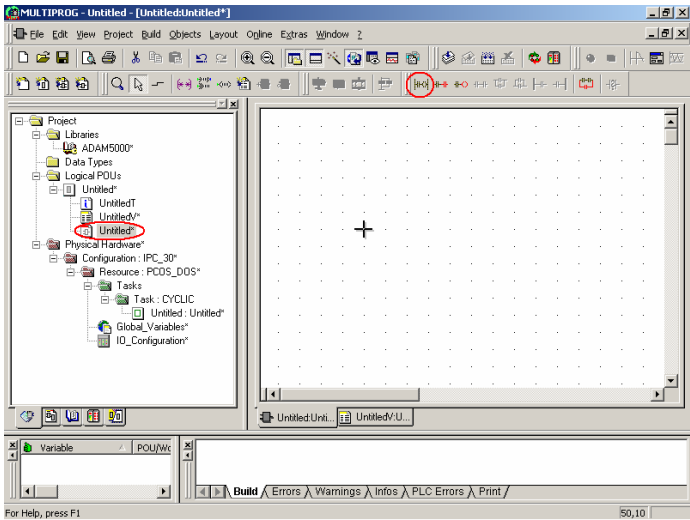

29. Double click “Contact C000” to set the parameters.

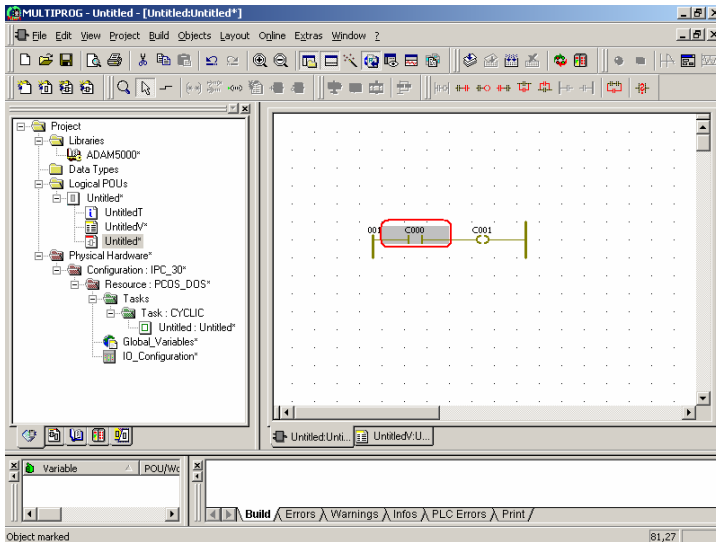

30. Fill in the Name and click “Apply”.

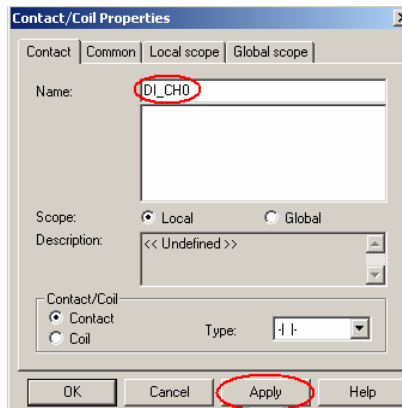

31. The screen will switch to “Common” folder. Please fill in the I/O Address and then click “Apply” and “OK”.

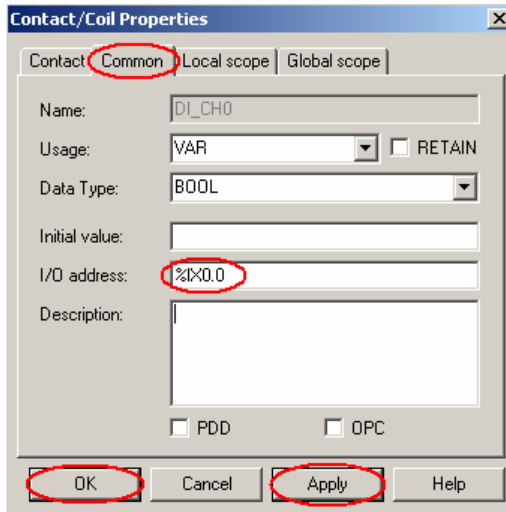

Where:

“%” is a declaration sign.

“I” is Input Location Prefix.

“B” is Byte for Size Prefix.

“0.0” is Memory Mapping Address.

Location prefix	Description
I	Physical input
Q	Physical output
M	Physical address in the PLC memory

Size prefix	Description
X	Single bit size (only with data type BOOL)
None	Single bit size
B	Byte size (8 bits)
W	Word size (16 bits)
D	Double word size (32 bits)
L	Long word size (64 bits)

32. Double click “Coil C001” to set the parameters.

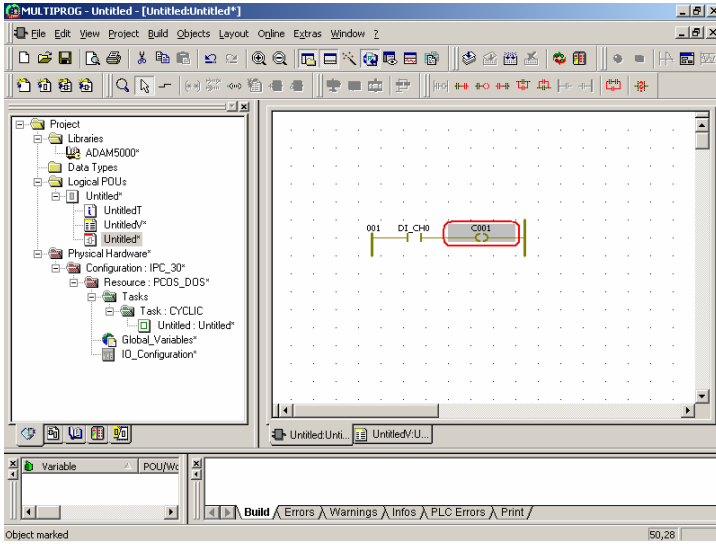

33. Fill in the Name and click “Apply”.

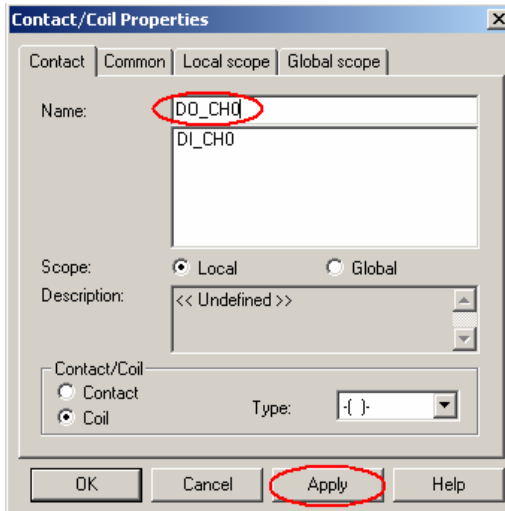

34. The screen will switch to “Common” folder. Please fill in the I/O Address and then click “Apply” and “OK”.

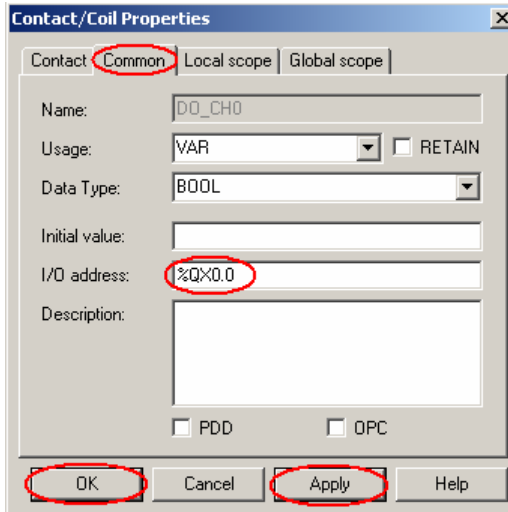

35. Click “Make” to build the execution file.

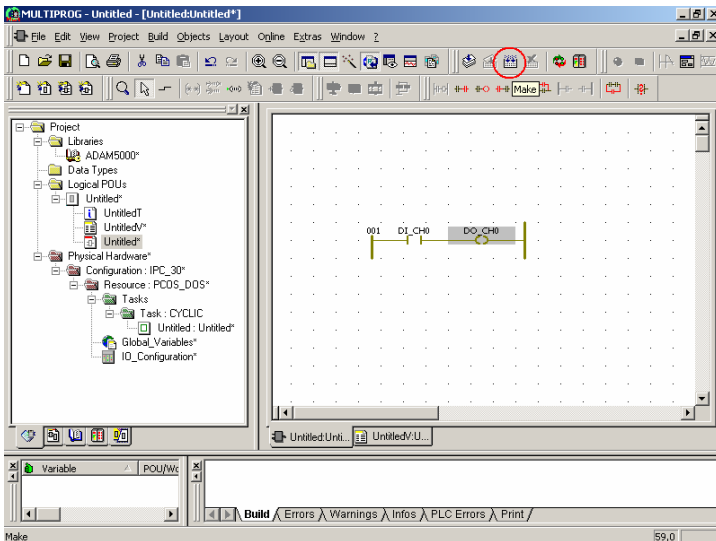

36. Check the project has been compiled successfully.

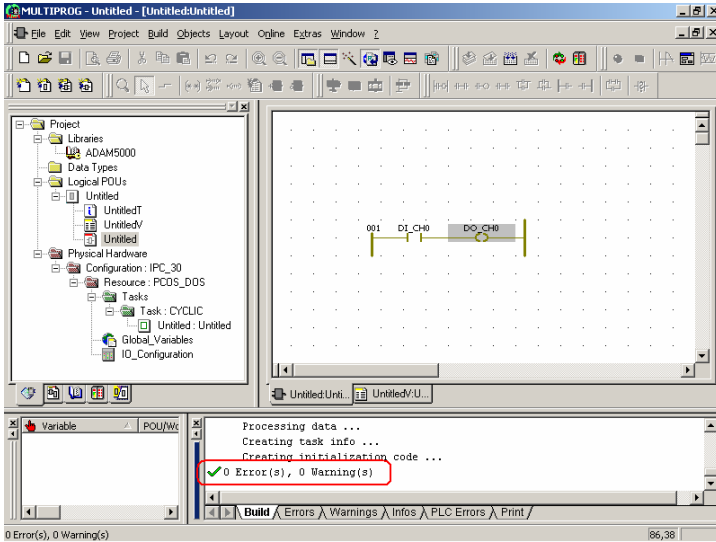

37. Click “Project Control Dialog”.

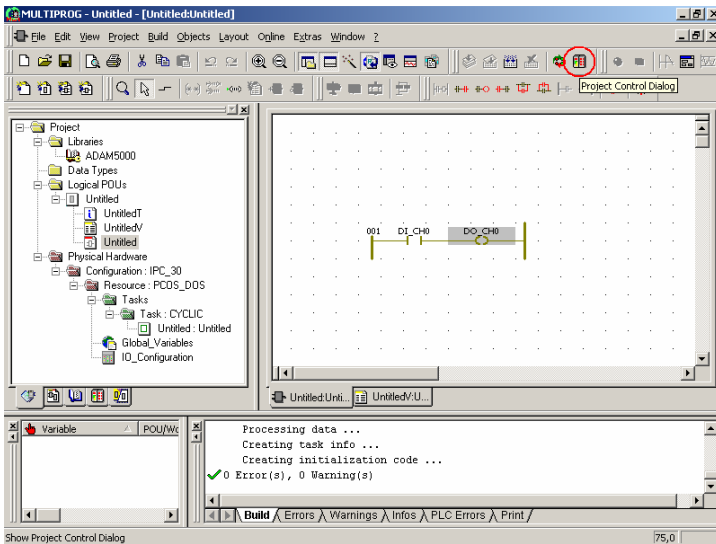

38. Click “Stop” if the “State” is “Run”.

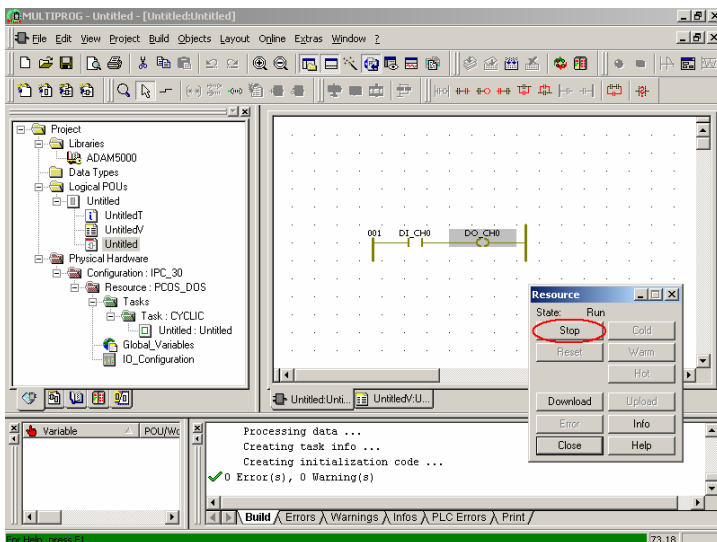

39. Click “Reset” to reset the ADAM-5510KW.

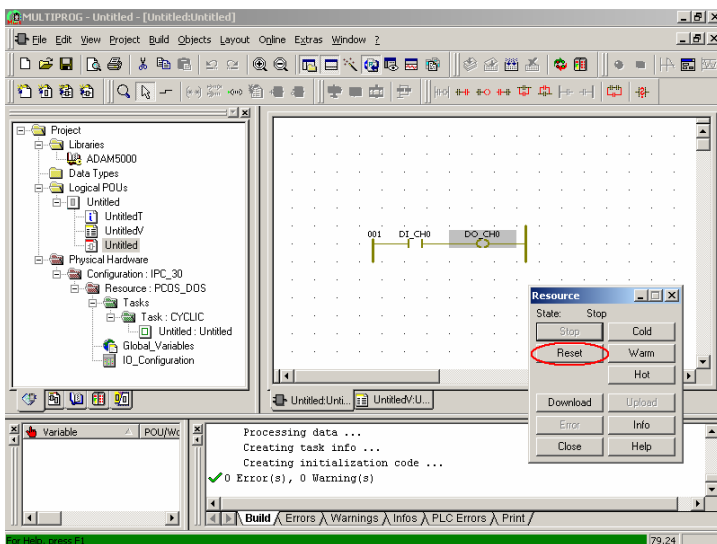

- Click “Download” to download the execution file to ADAM-5510KW.

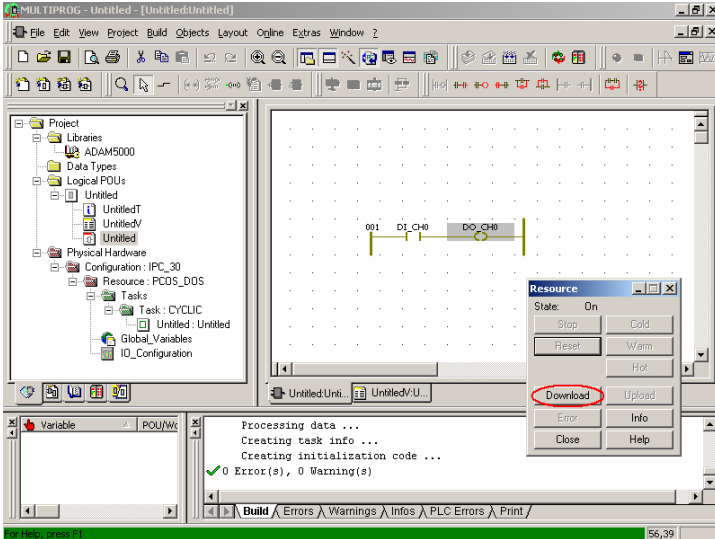

- Click “Download” button as below to start the download process.

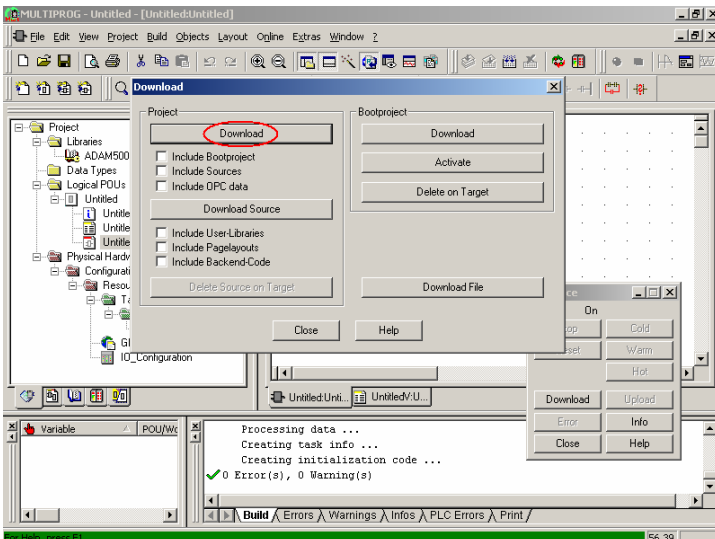

42. Click “Cold” to execute a cold start. During a cold start all data are initialized.

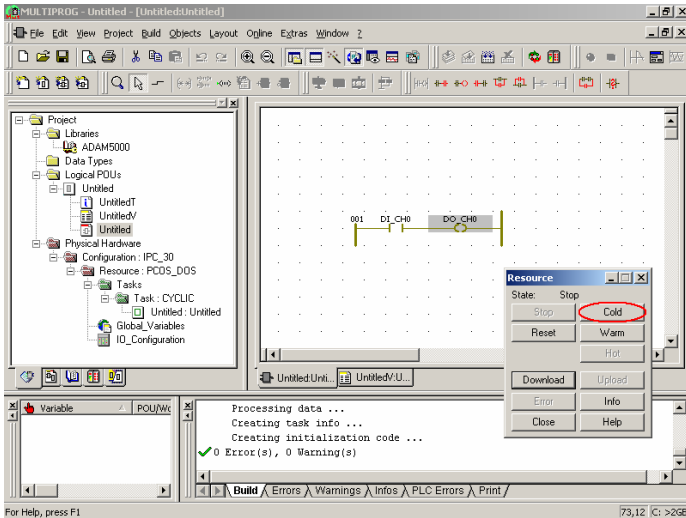

43. The ADAM-5510KW is running correctly when you see the status bar turns green color.

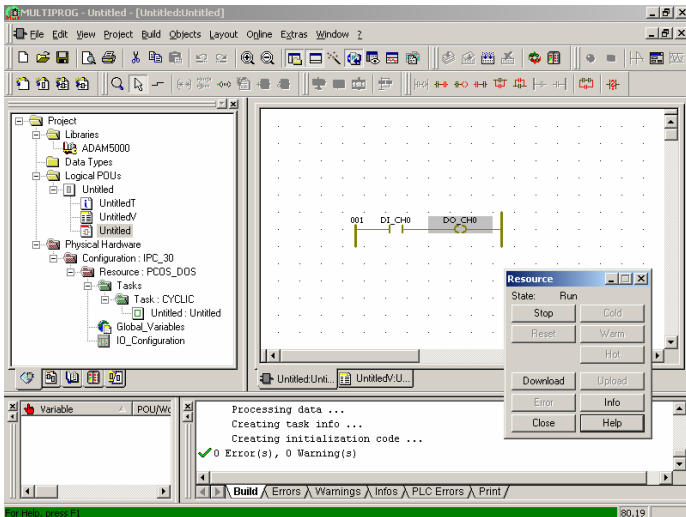

44. Click “Debug On/Off” to turn on the debug function.

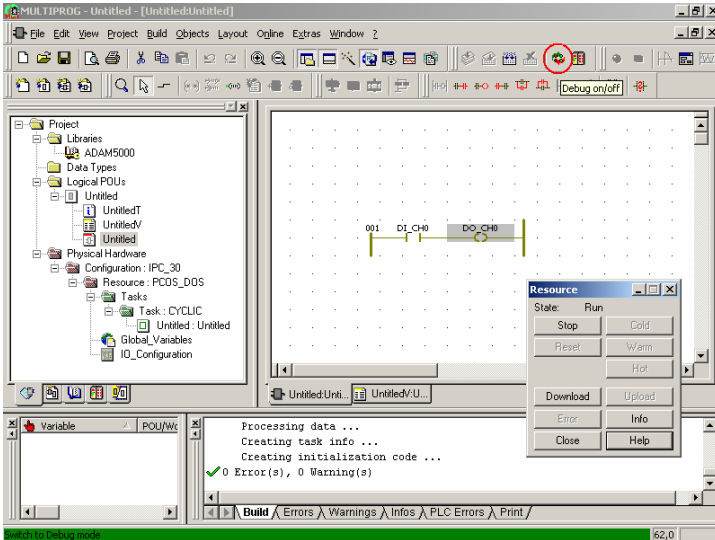

45. You can see the DI_CH0 and DO_CH0 are turned blue color. It means the state is FALSE.

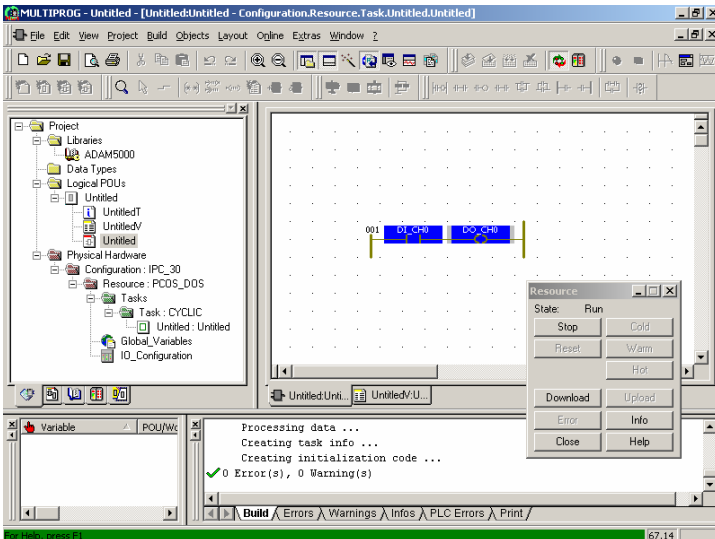

Chapter 3 Quick Start

46. When you change the state of ADAM-5051D CH0, you will see the DI_CH0 and DO_CH0 are turned red color. It means the state is TRUE.

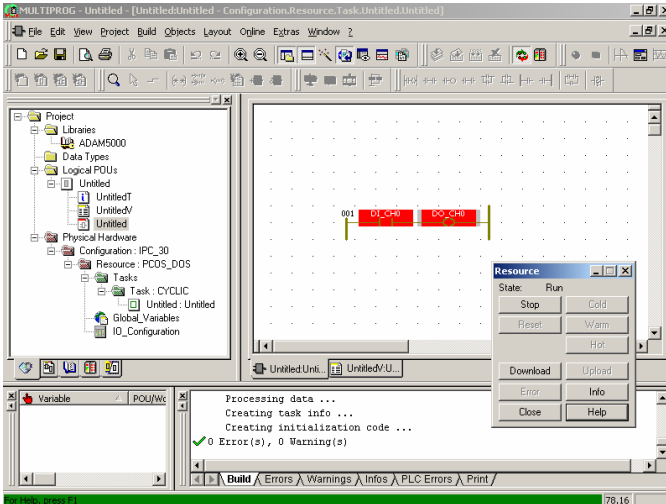

47. When you change back the state of ADAM-5051D CH0, you will see the DI_CH0 and DO_CH0 are turned blue color again. It means the state returns to FALSE.

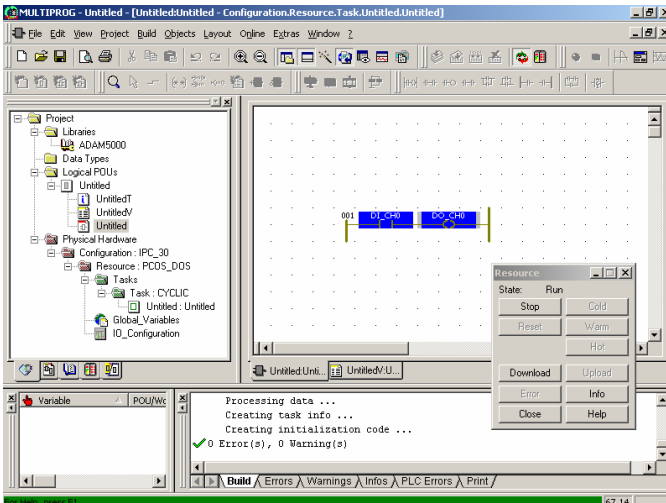

48. Double-click “DI_CH0 Contact”. Select “TRUE” and click “Force” to force the state of DI_CH0 Contact to TRUE.

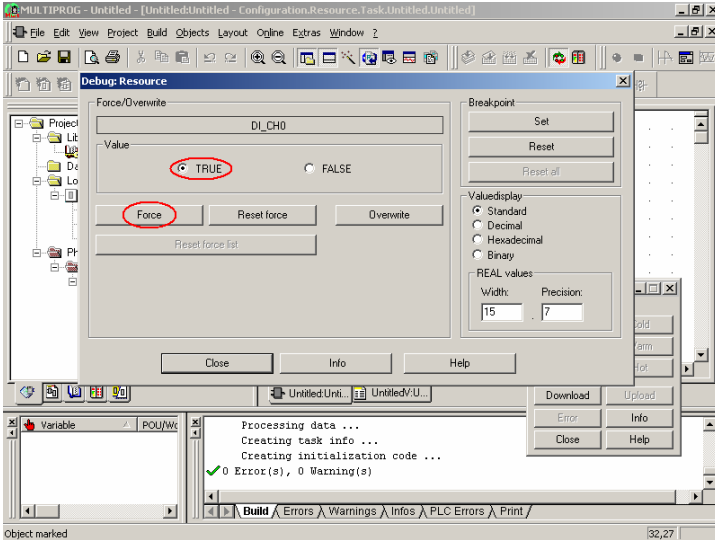

49. You will see the DI_CH0 and DO_CH0 are turned red color. It means the state is forced to TRUE.

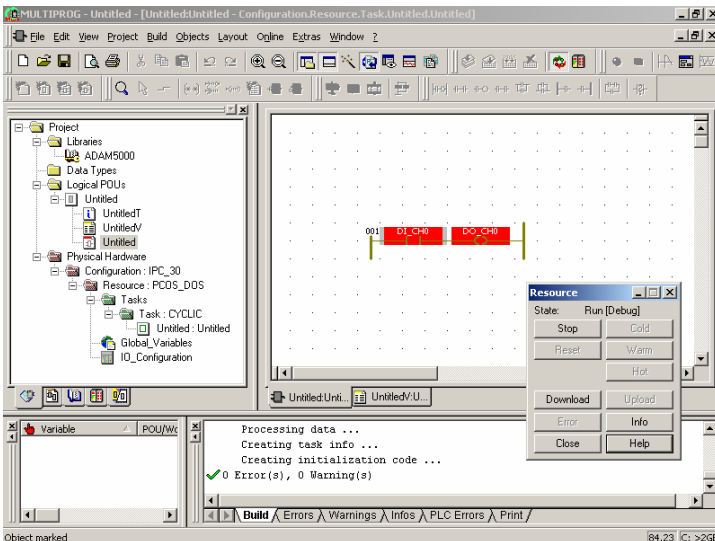

Chapter 3 Quick Start

50. Double-click “DI_CH0 Contact” and then click “Reset force” button to reset the force state of DI_CH0 Contact to previous state.

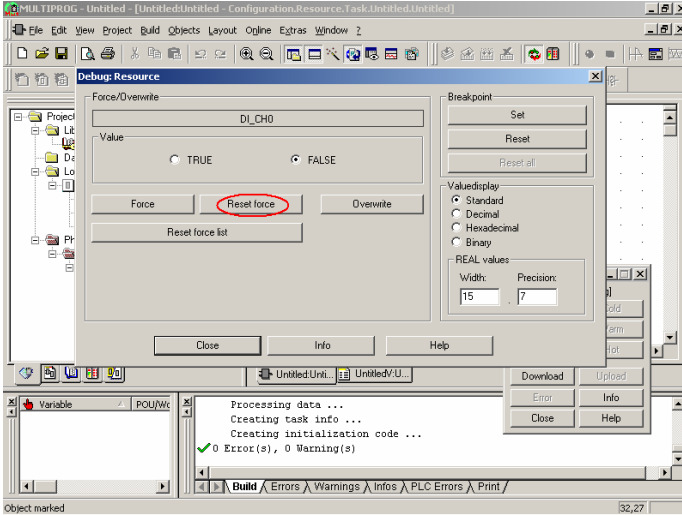

51. Click “Stop” to stop the execution program in ADAM-5510KW.

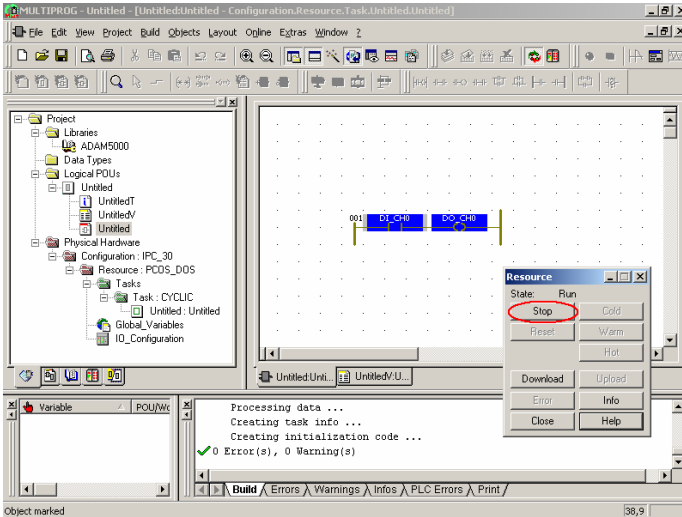

52. Click “Close” to quit the control dialog.

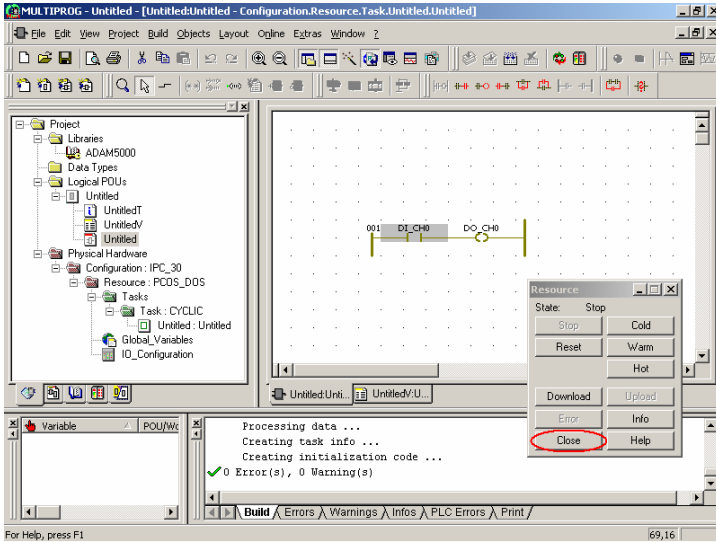

53. You can save the project if you need to keep it.

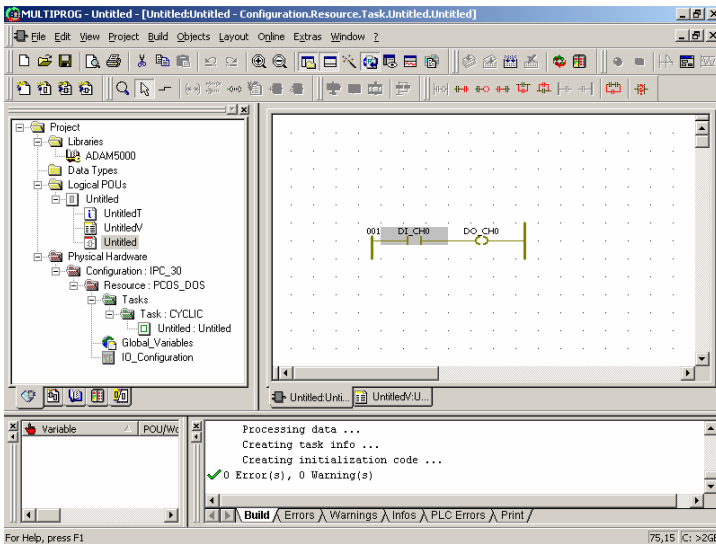

54. Finished.

4

Multiprog via Ethernet

Chapter 4 Multiprog via Ethernet

In Chapter 3, the Multiprog software connects to ADAM-5510KW Series Controller via serial port. For Ethernet-enabled controller such as ADAM-5510EKW/TP, Multiprog software also supports to connect to the controller via Ethernet port. In the following, the IP address setting and Multiprog via Ethernet will be demonstrated. **Please note the default IP address of ADAM-5510EKW/TP is “10.0.0.1”.**

4.1 Configure IP address when firmware version is 1.21 or later

1. Open a new project, click “Project Control Dialog” button and then click “Info” button to check whether firmware version is 1.21 or later.

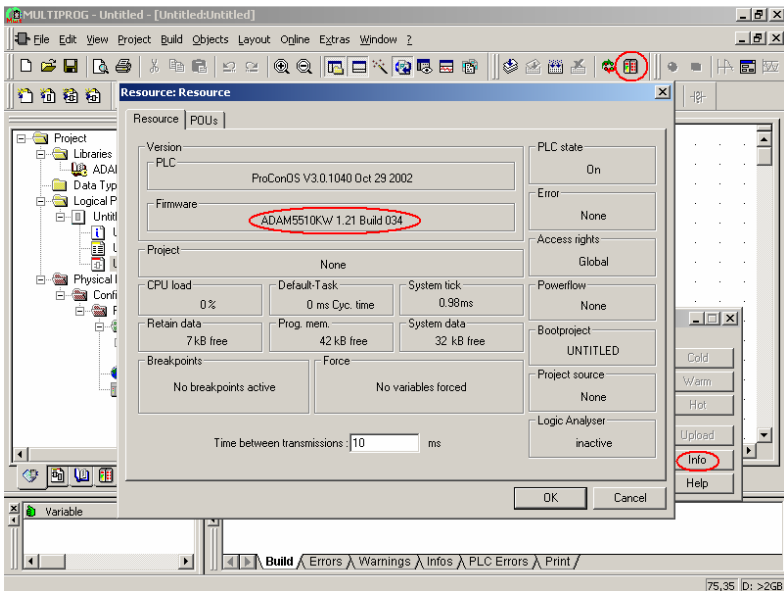

2. Click “IO_Configuration\Open Worksheet” button.

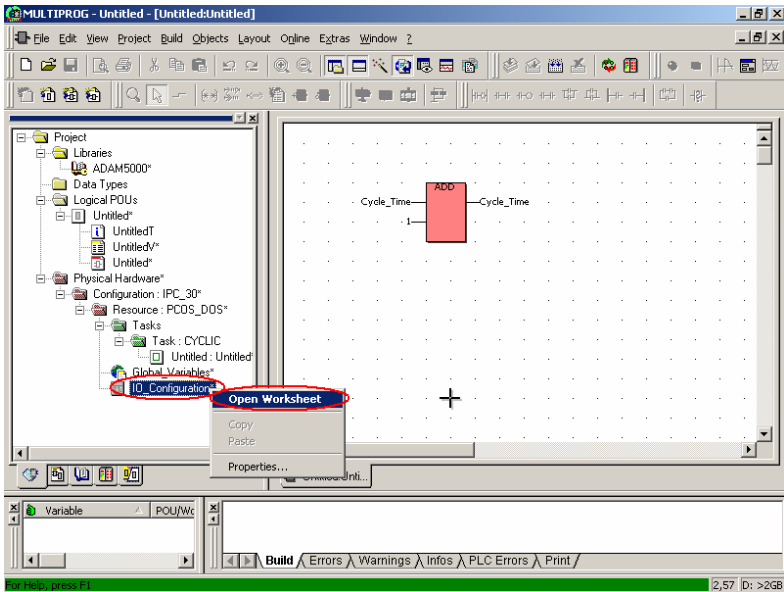

3. Click “Property” button.

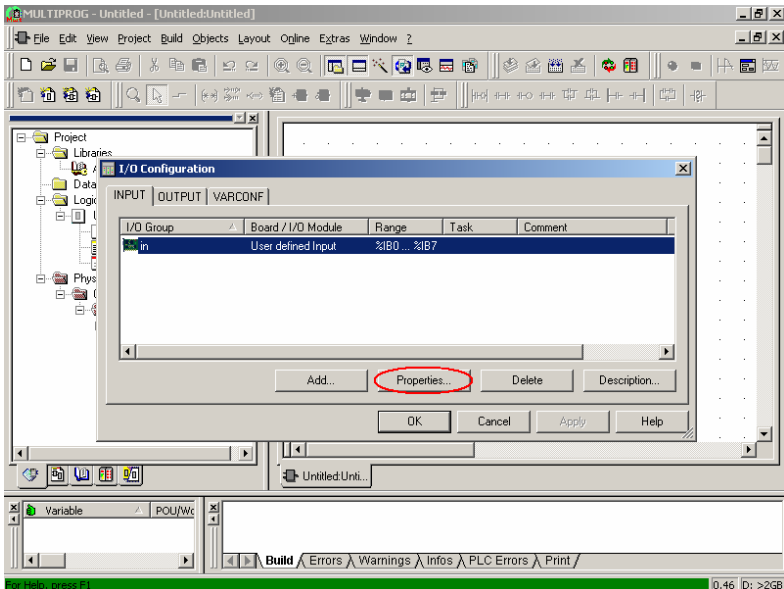

Chapter 4 Multiprog via Ethernet

4. Select “Advantech ADAM5510KW” and then click “Driver Parameter” button.

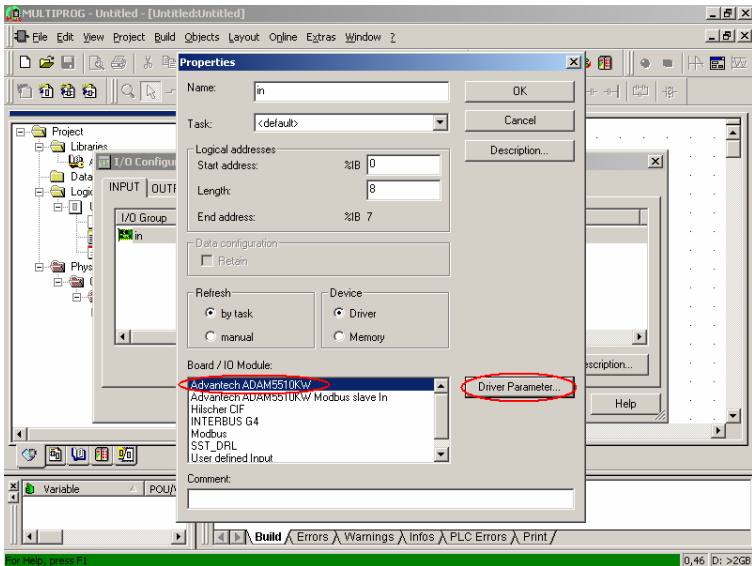

5. Click “ADAM5510KW system setup” button.

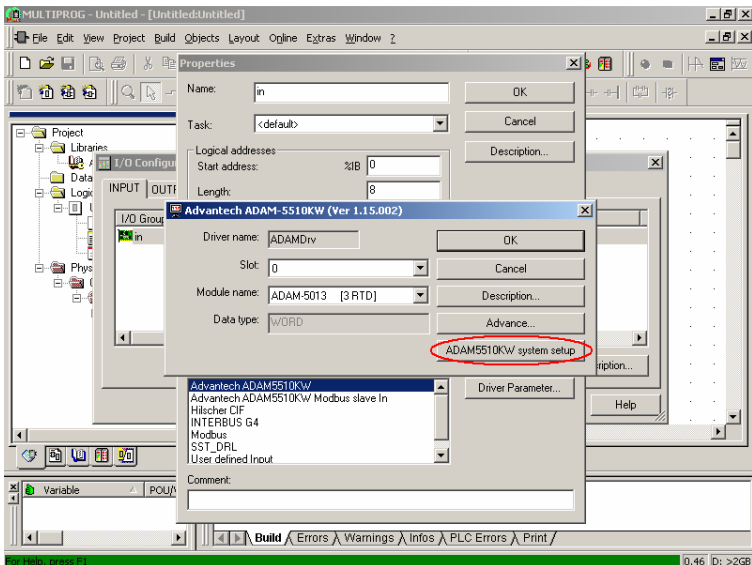

6. Configure the IP address and Timeout settings.

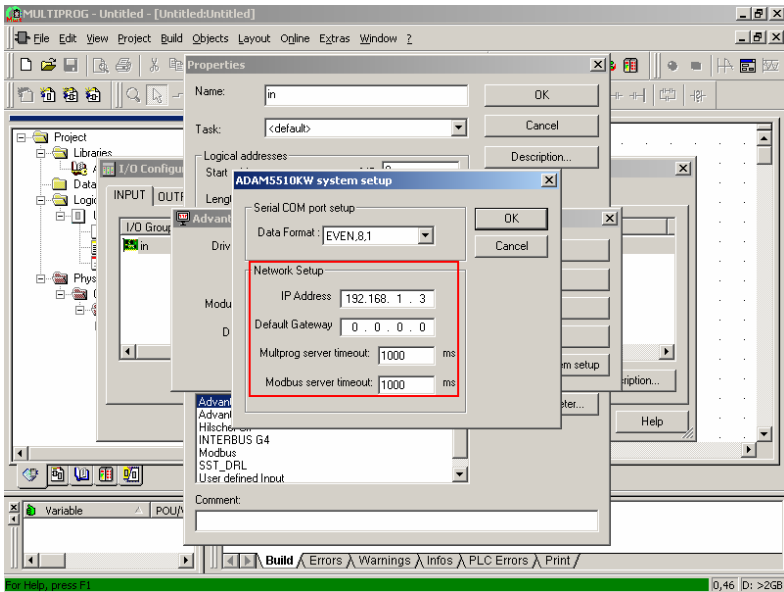

7. Click “Apply” and “OK” buttons.

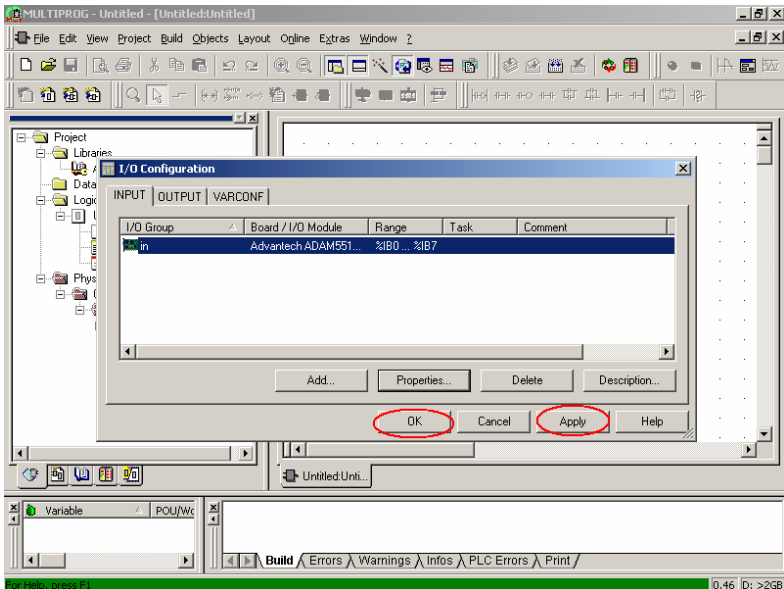

Chapter 4 Multiprog via Ethernet

8. Click “Make” button.

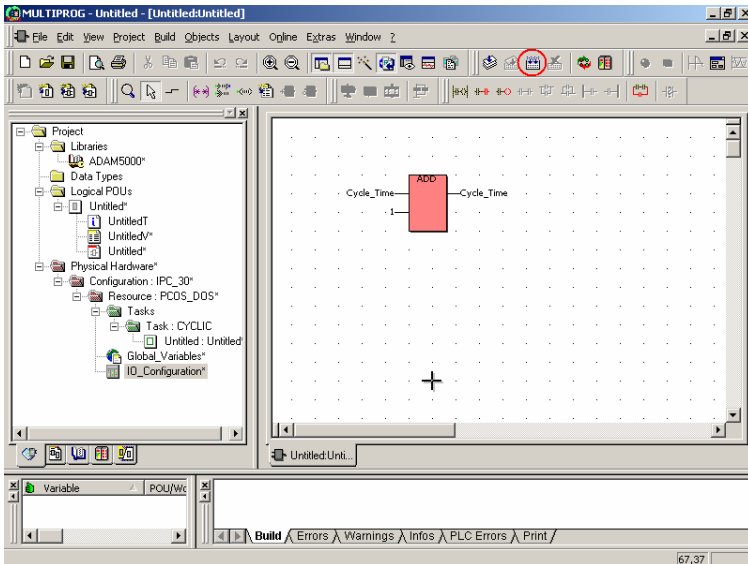

9. Click “Project Control Dialog” button when project is compiled correctly.

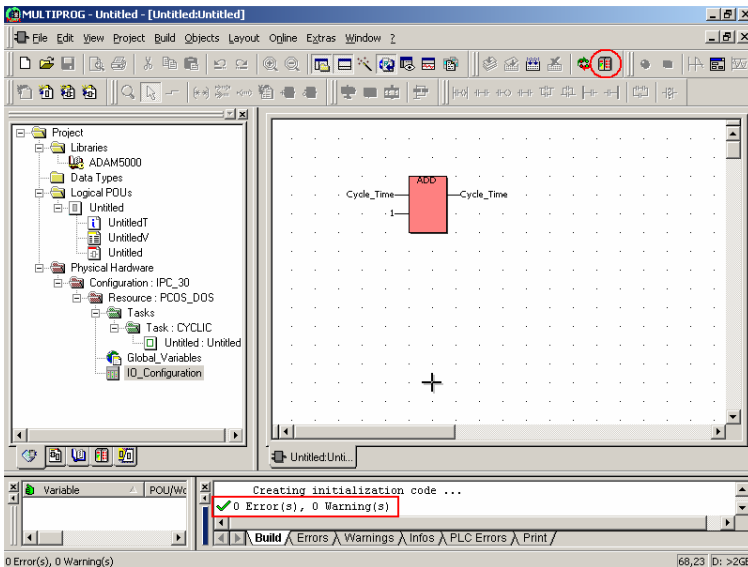

10. Click “Download” button.

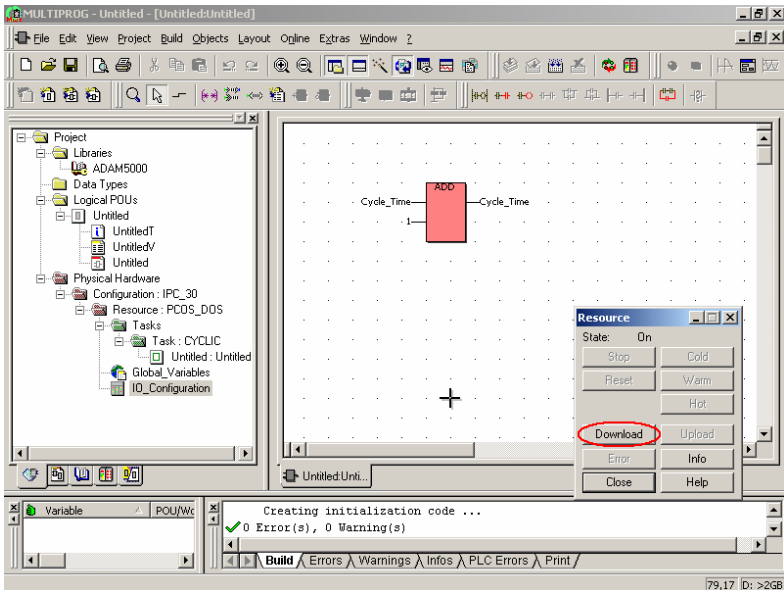

11. Select “Include Bootproject” and then click “Download” button.

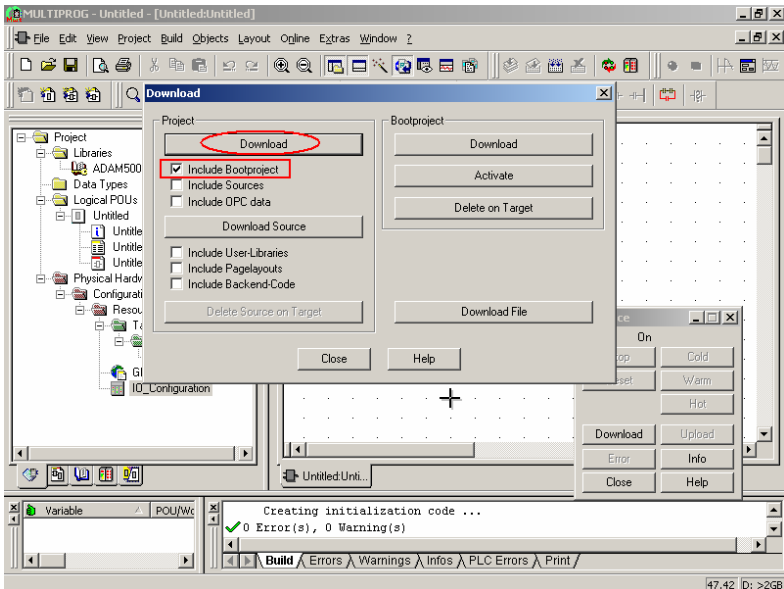

Chapter 4 Multiprog via Ethernet

12. Download is finished as following.

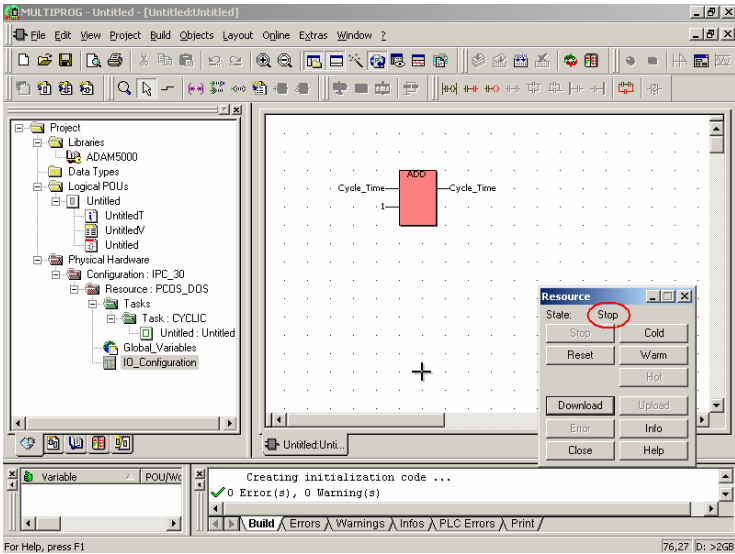

13. Press Reset button on ADAM-5510KW Series Controller. The PWR/RUN/COMM LEDs will be turned on and the state will be changed to “Timeout”.

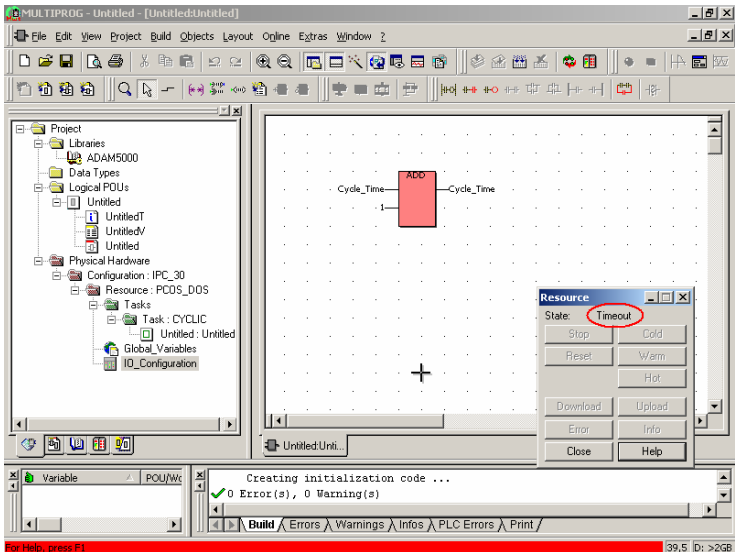

14. When RUN/COMM LEDs are turned off, press Reset button one more time. The state will be changed to “On”.

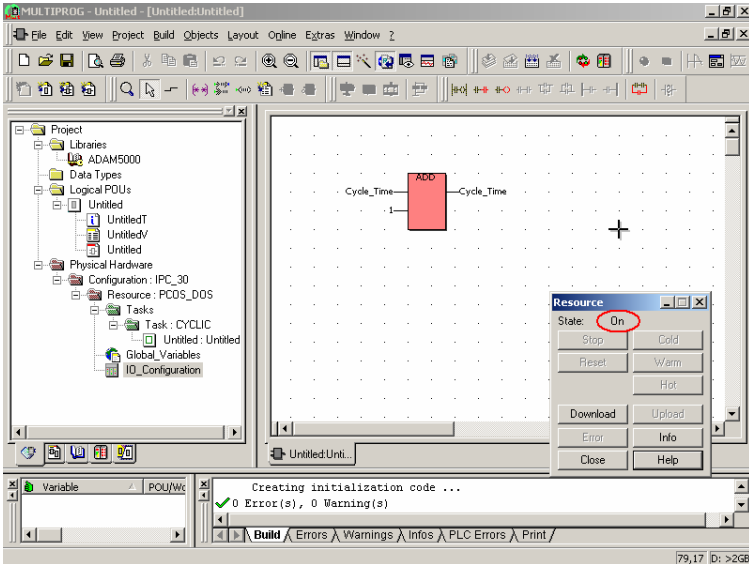

15. Check the IP address setting by downloading a project. Click “Resource\Settings” button as following.

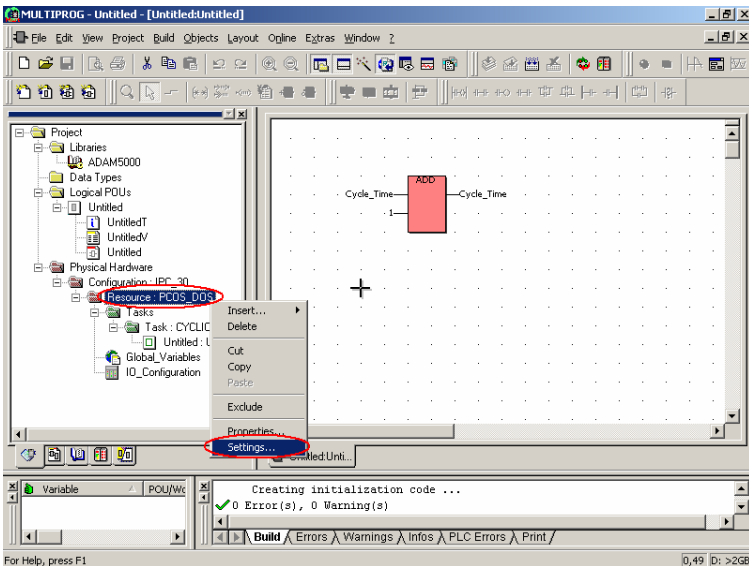

Chapter 4 Multiprog via Ethernet

16. Click “DLL” button and then set the new IP address as following.

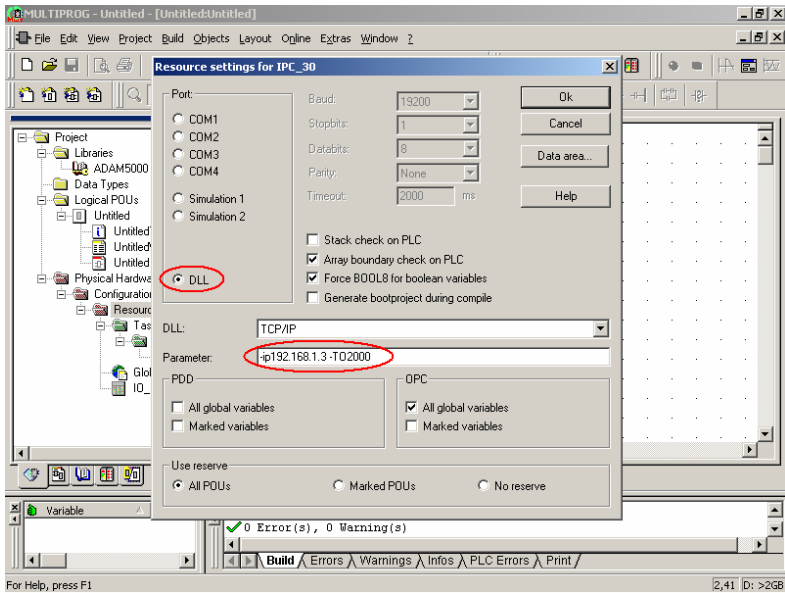

17. Click “Project Control Dialog” button and check the State is “On”.

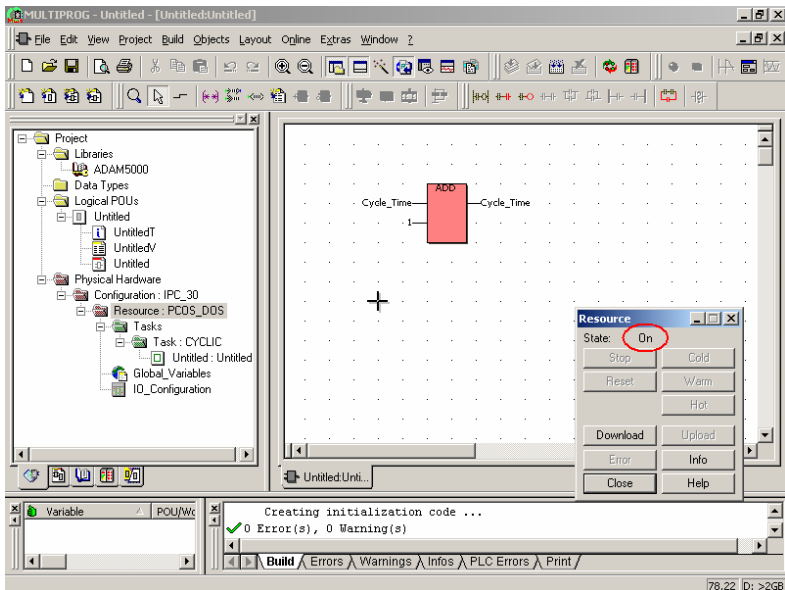

18. Select “Include Bootproject” and then click “Download” button.

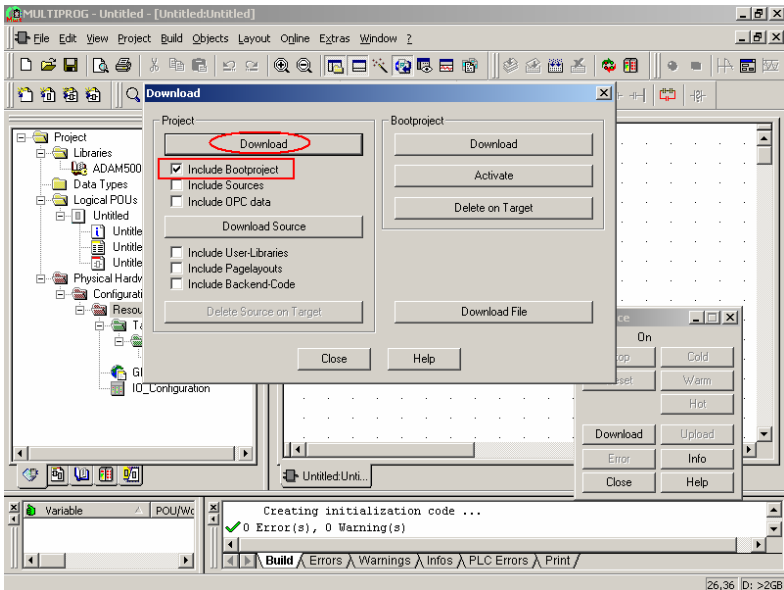

19. Project is downloading.

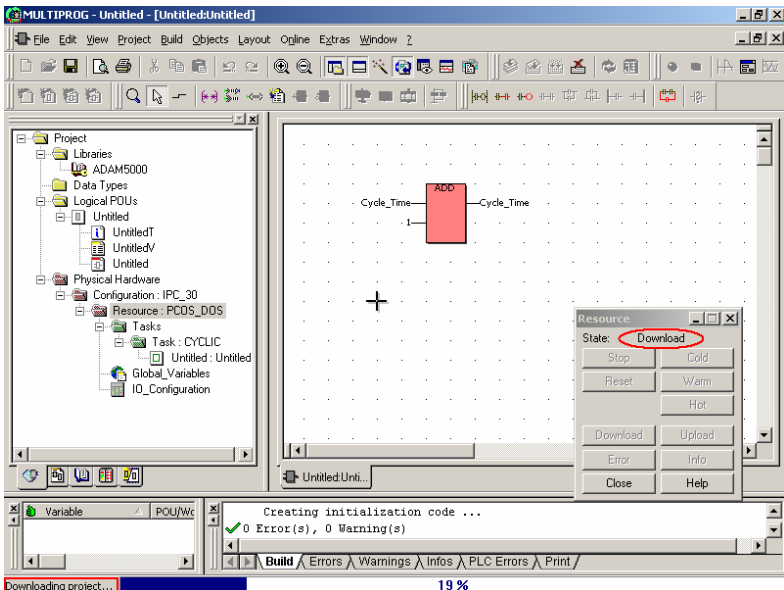

Chapter 4 Multiprog via Ethernet

20. Download is finished. Click “Cold” button to run the project.

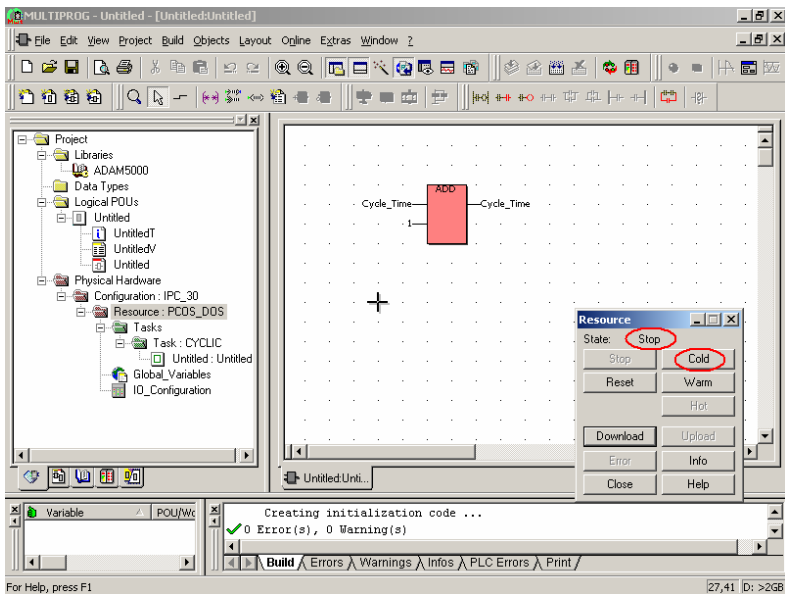

21. The project is running correctly. IP address setting is successful.

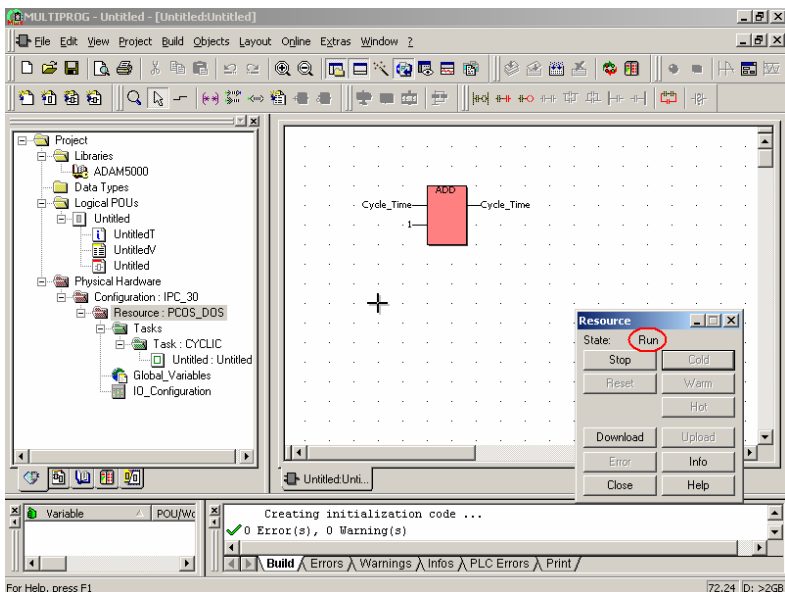

4.2 Configure IP address when firmware version is less than 1.21

1. Insert the Advantech Multiprog CD and setup ADAM-5510 Utility by running ADAM-5510SeriesUtility.exe under "ADAM-5510 Series" directory. If you cannot find the file, please download the ADAM-5510 Series Utility from Advantech Support Site. (<http://www.advantech.com>)
2. Short the INIT* pin to GND pin and then reset ADAM-5510KW Series Controller

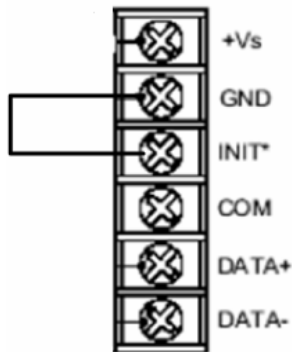

Chapter 4 Multiprog via Ethernet

3. Run ADAM-5510 Series Utility and click Launch Terminal button.

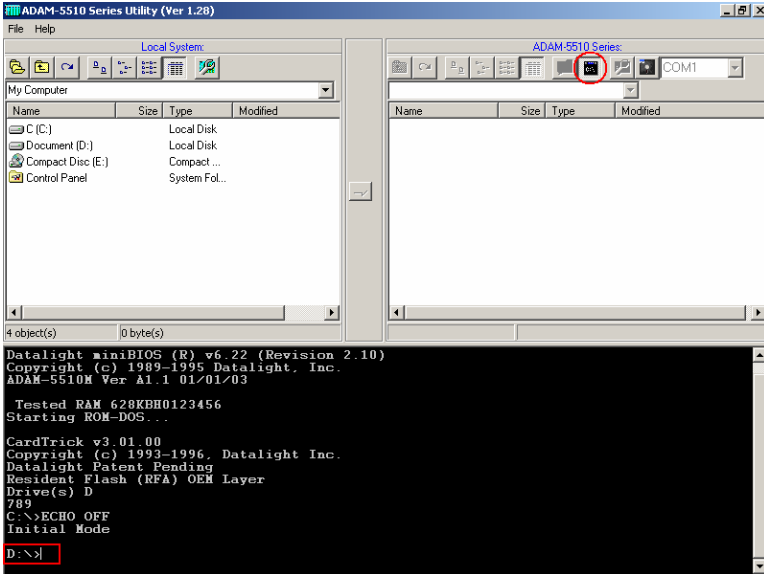

4. Click Refresh button.

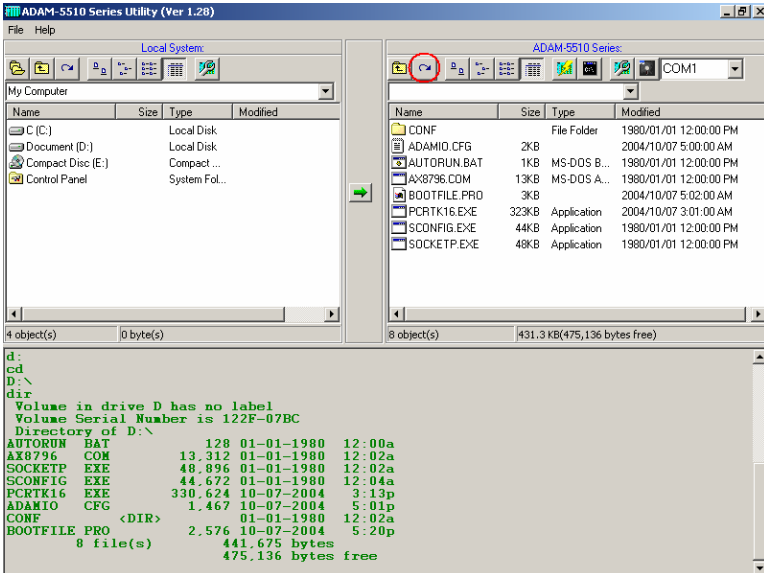

5. Click Network Configuration button and input IP address settings.

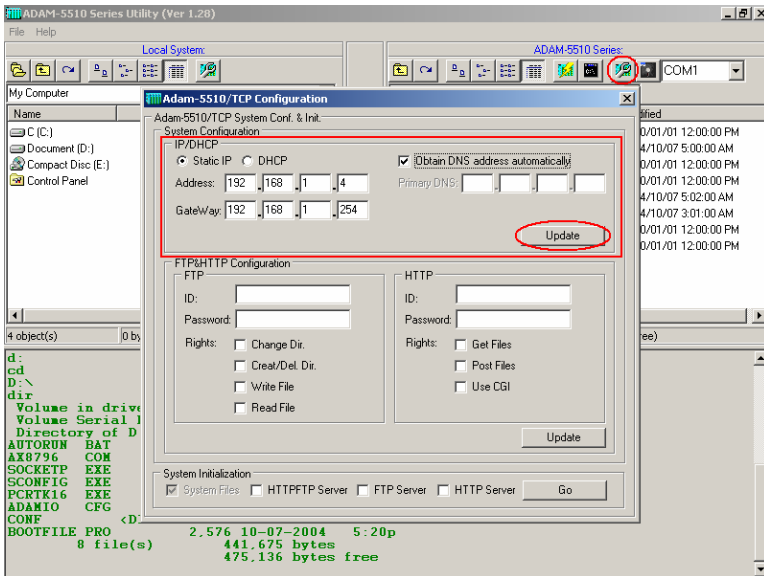

6. Configure the IP address settings successfully.

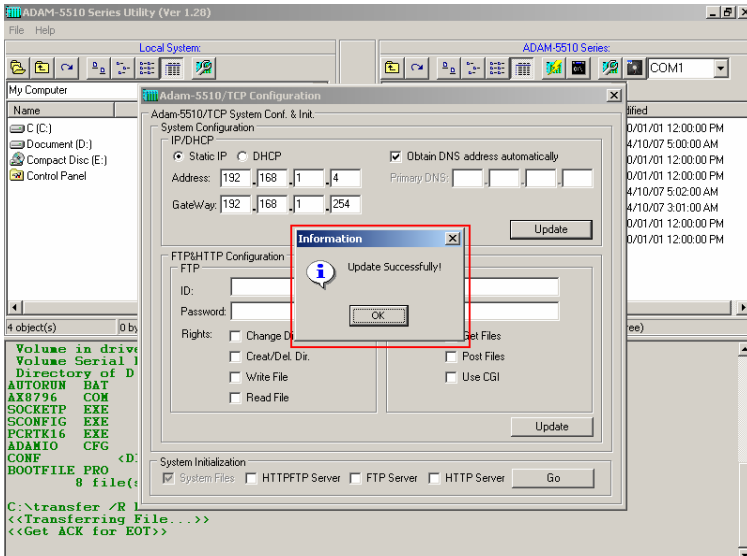

Chapter 4 Multiprog via Ethernet

7. Remove the connection between INIT* pin and GND pin. Check whether the IP address is as expected.

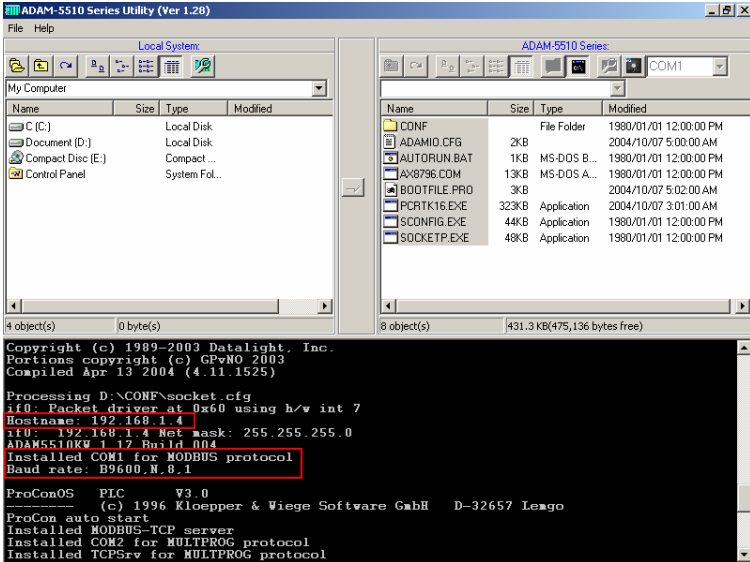

4.3 Multiprog via Ethernet port

1. Make sure the Ethernet connection and load the project in Multiprog. Right click the Resource and select Settings.

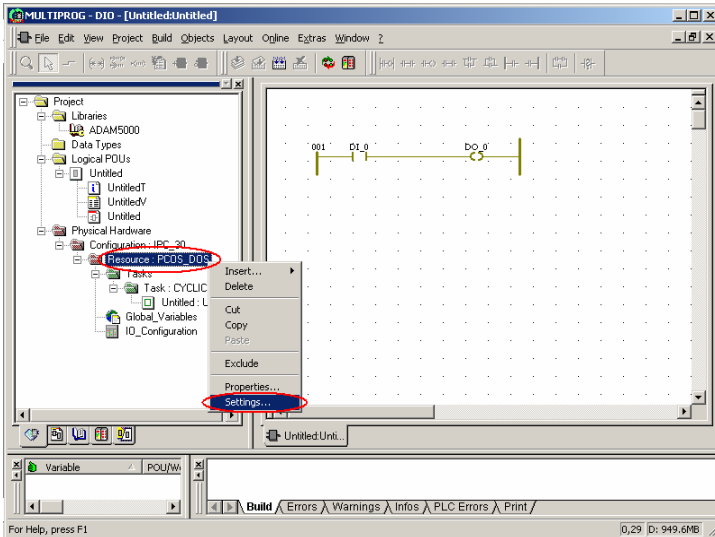

2. Input the IP address of ADAM-5510KW Series Controller.

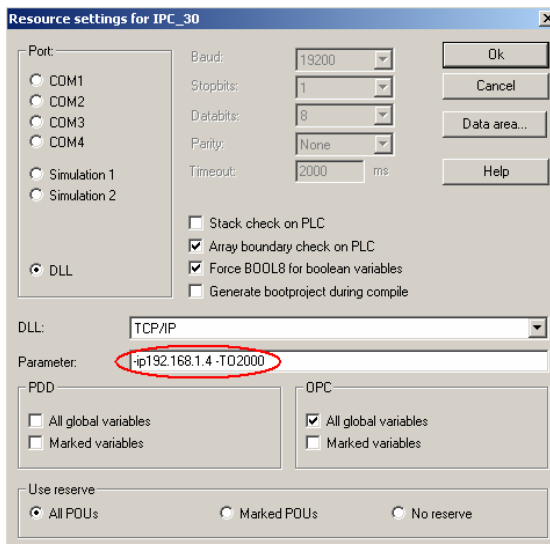

Chapter 4 Multiprog via Ethernet

3. Click Make button to compile the project and then click Project Control Dialog button to download and run the project.

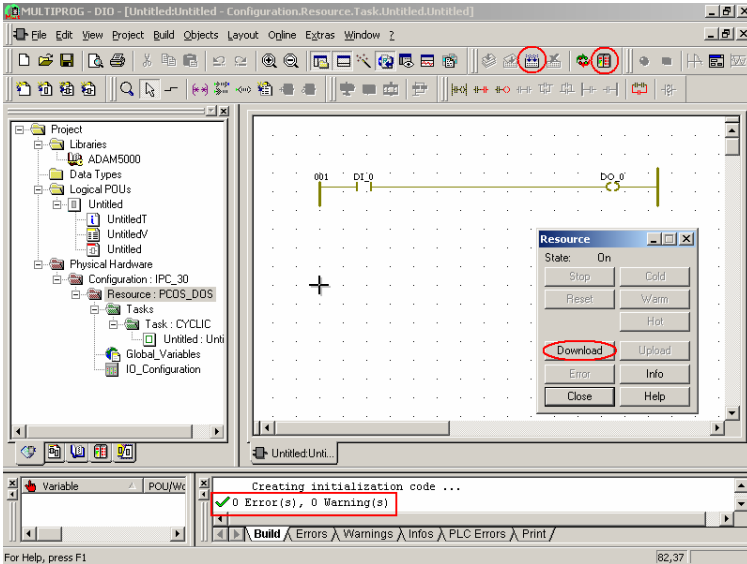

4. Select Include bootproject item and click Download button.

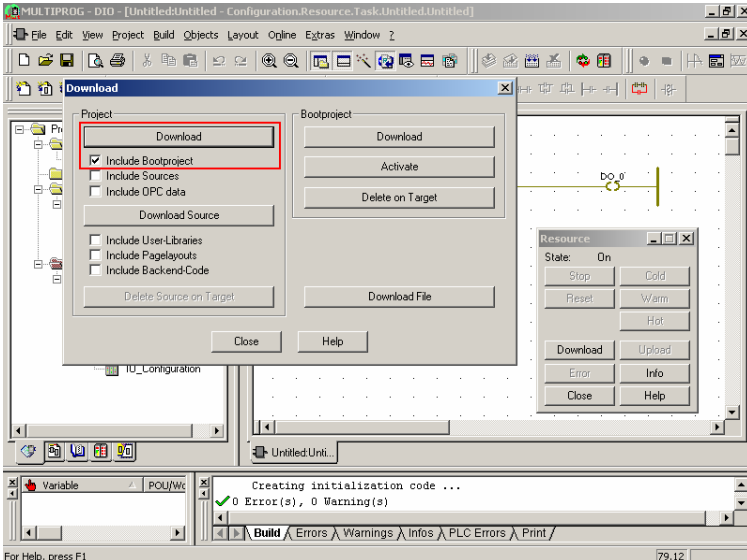

5. Project is downloading.

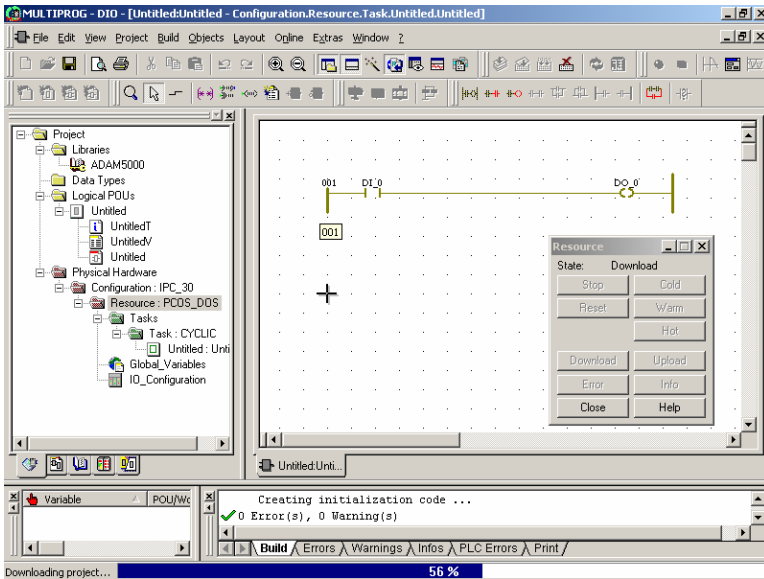

6. Click Cold button to run the project.

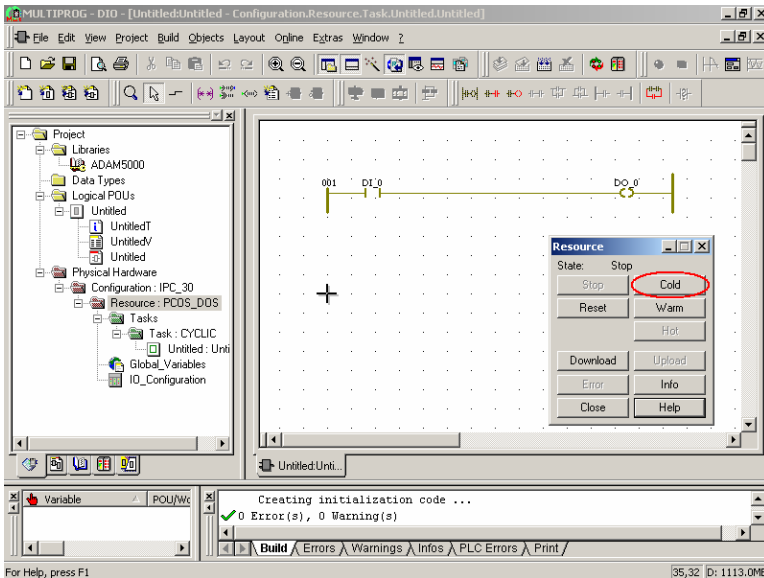

Chapter 4 Multiprog via Ethernet

7. Click Debug On/Off button to turn on the debug mode.

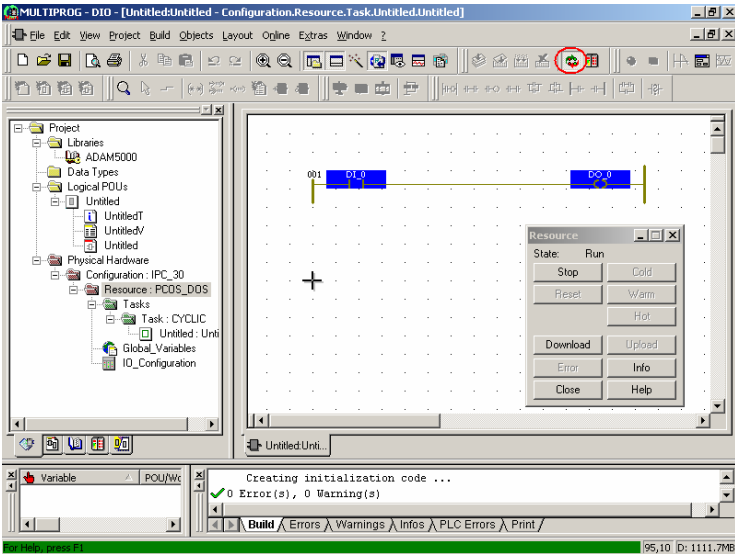

8. Change the state of DI bit 0 and check the state of DO bit 0 is changed.

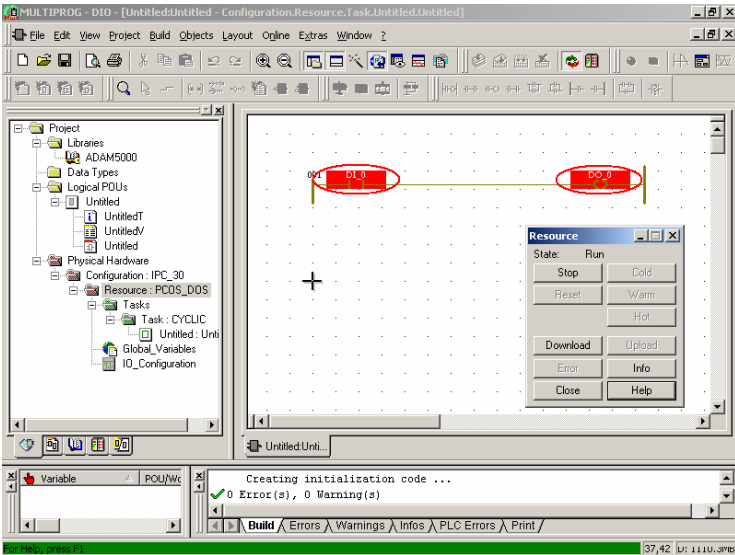

5

Modbus Functions

Chapter 5 Modbus Functions

5.1 Introduction

The Modbus functions of ADAM-5510KW Series Controller are powerful features which provide high expansibility and flexibility for user's applications. The supported modbus functions include following items.

- Modbus/RTU Master Function: Connect to Modbus/RTU remote I/O modules such as Modbus modules of ADAM-4000 series.
- Modbus/RTU Slave Function: Connect to HMI/SCADA software or Modbus master devices via serial port.
- Modbus/TCP Server Function: Connect to HMI/SCADA software via Ethernet port.
- Modbus/TCP Client Function: Connect to Modbus/TCP remote I/O modules such as ADAM-6000 series.

5.2 Modbus/RTU Master Function

The Modbus/RTU master function is only supported by COM4 of ADAM-5510KW Series Controller. There are typical 32 I/O modules can be connected to COM4 for most of the applications. So far, there are 12 modules of ADAM-4000 Series support modbus protocol as following list. (Please refer to ADAM-4000 User's Manual for latest support list.)

Module Name	Description
ADAM-4015	6-channel RTD Input Module
ADAM-4015T	6-channel Thermistor Input Module
ADAM-4017+	8-channel Analog Input Module
ADAM-4018+	8-channel Thermocouple Input Module
ADAM-4022T	Dual-loop PID Controller
ADAM-4024	4-channel Analog Output Module
ADAM-4051	16-channel Isolated Digital Input Module
ADAM-4055	16-channel Isolated Digital Input/Output Module
ADAM-4056S	12-channel Sink Type Isolated Digital Output Module
ADAM-4056SO	12-channel Source Type Isolated Digital Output Module
ADAM-4068	8-channel Relay Output Module
ADAM-4069	8-channel Power Relay Output Module

5.2.1 An example to demonstrate how to connect COM4 to ADAM-4015T for Modbus/RTU master function.

1. Check jumper settings and wiring.

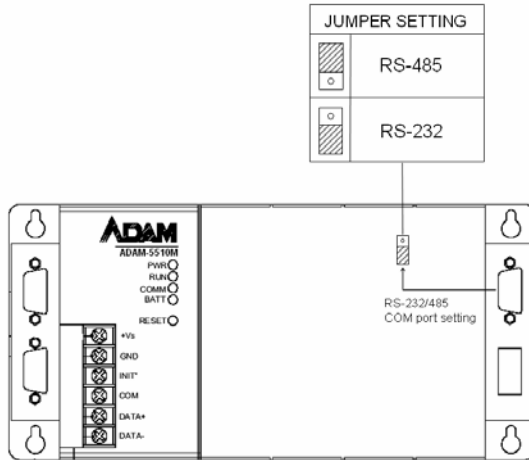

Figure 5.1 ADAM-5510KW COM4 jumper setting

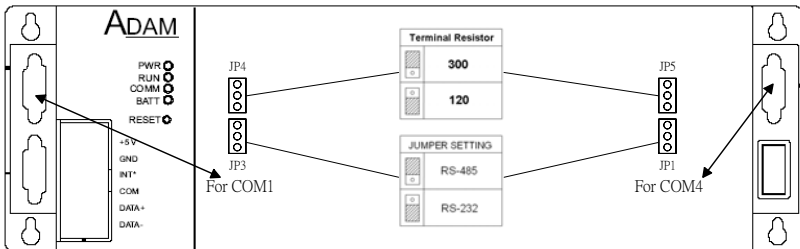

Figure 5.2 ADAM-5510EKW and ADAM-5510EKW/TP COM4 jumper setting

Pin No.	Description
Pin 1	DATA-
Pin 2	No Connection
Pin 3	No Connection
Pin 4	DATA+
Pin 5	No Connection
Pin 6	No Connection
Pin 7	No Connection
Pin 8	No Connection
Pin 9	No Connection



Figure 5.3 RS-485 pin assignment

Chapter 5 Modbus Functions

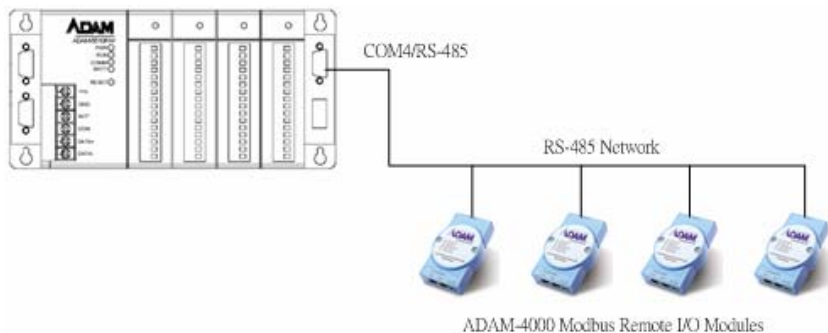
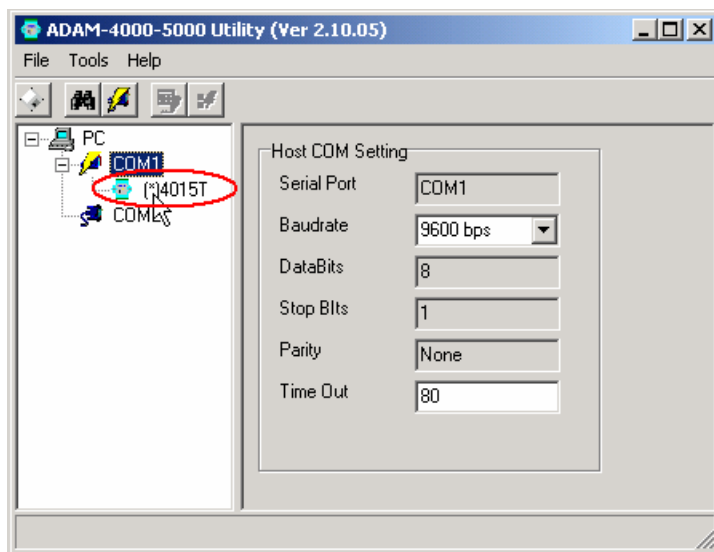
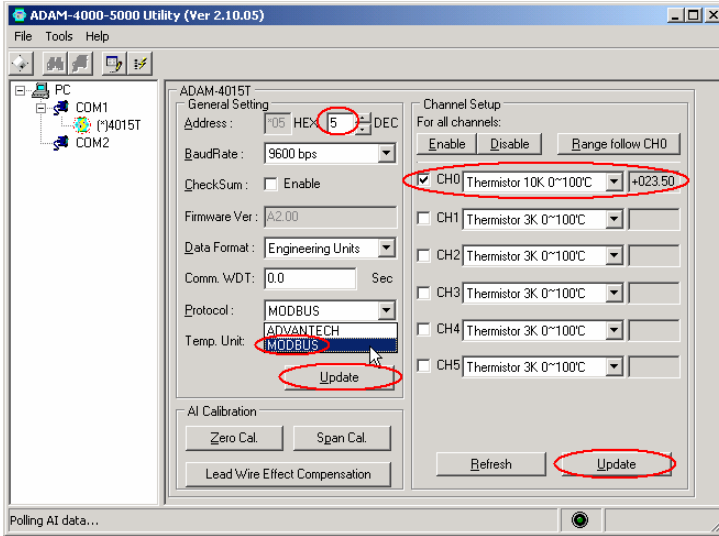

Figure 5.4 Wiring of Modbus/RTU Slave Function

2. For setting the ADAM-4015T to Modbus protocol, you should connect the 'INIT*' to 'GND' and run ADAM-4000-5000 Utility.



3. Change the protocol type to 'MODBUS', configure the channels to 'Thermistor 10K' sensor and then click 'Update'.



4. Remove the INIT* pin and then reset ADAM-4015T. Check the Modbus Mapping status and other settings are correct.

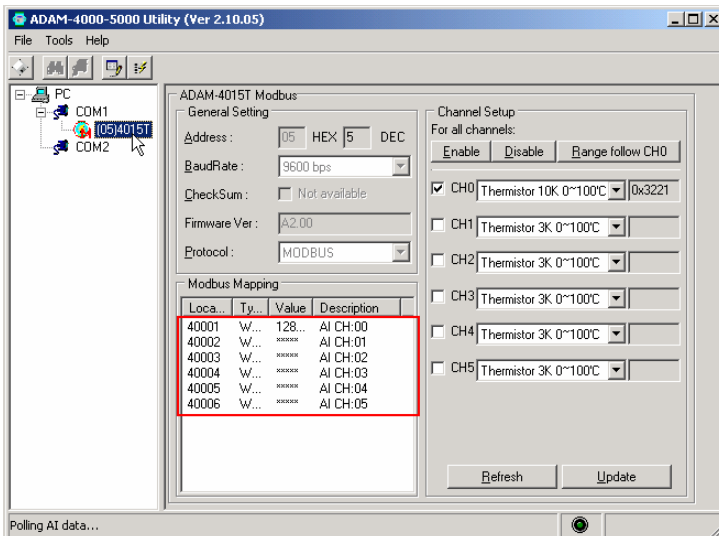

Chapter 5 Modbus Functions

5. Connect ADAM-4015T to COM4 of ADAM-5510KW Series Controller by Figure 5-4 and then run Multiprog. Double click on the "IO_Configuration". Click on "Add" to add a new input module.

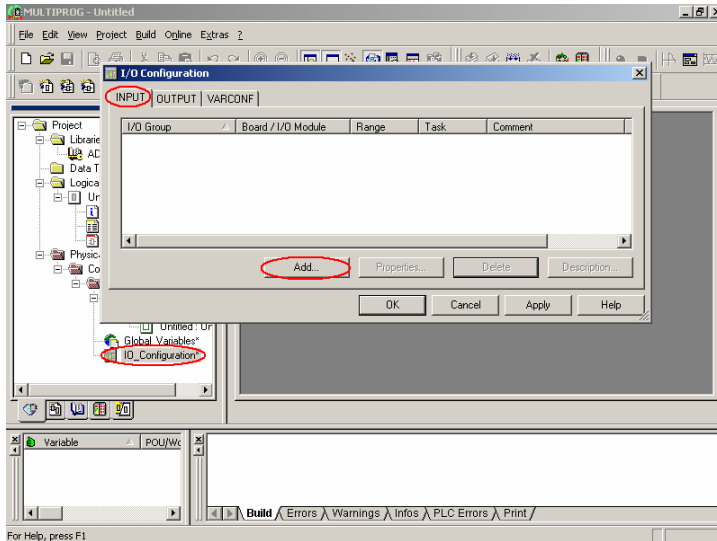

6. Type the name "RM_4015". Set the length to "12". (One AI channel needs 2 bytes length.) Select "Read Modbus slave" for Modbus/RTU slave function. Click "Driver Parameter" for Modbus settings.

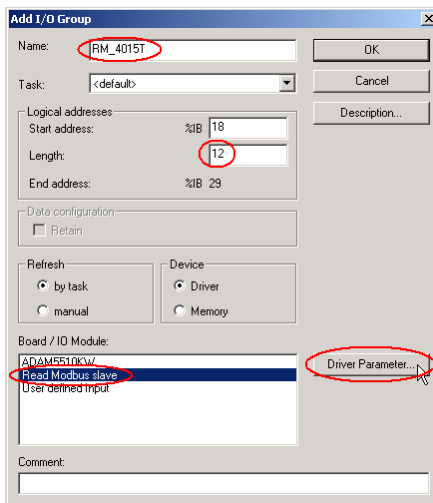

7. Set the device ID to 1 and check if it is the same with DIP switch setting of ADAM-5510KW Series Controller. The setting of “Modbus Slave ID” is 5, “Start Address” is 4X001 and “Length” is 6. Click “Advance” for further settings.



8. Optimise timeout settings for the system in order to increase system performance.

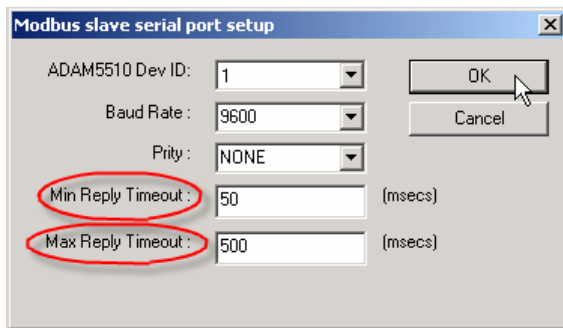

Note: Please be sure to press the “OK” button to save all the settings as configuration INI, even the default value must do this.

Chapter 5 Modbus Functions

5.2.2 Following example can show how to connect COM4 to ADAM-4056S for Modbus/RTU master function.

Note: In following example, only some pictures are shown for reference because the procedures for configuring the settings are similar.

ADAM-4056S settings:

ID address: 1

Protocol: Modbus

Baud rate: 9600

Data format: NOPARITY,8,1

ADAM-5510KW Series Controller settings:

Slot 0: ADAM-5051D

Other settings are the same as section 5.2.1

Multiprog settings:

LDI_0: ADAM-5051D DI bit 0

RDO_0: ADAM-4056S DO bit 0

Board I/O Modules: Write modbus slave

ADAM-4056S DO channel's Modbus start address: 00017

Note: "Read modbus slave" item is available for reading DI module.

1. Configure ADAM-551D DI bit 0 in Multiprog.

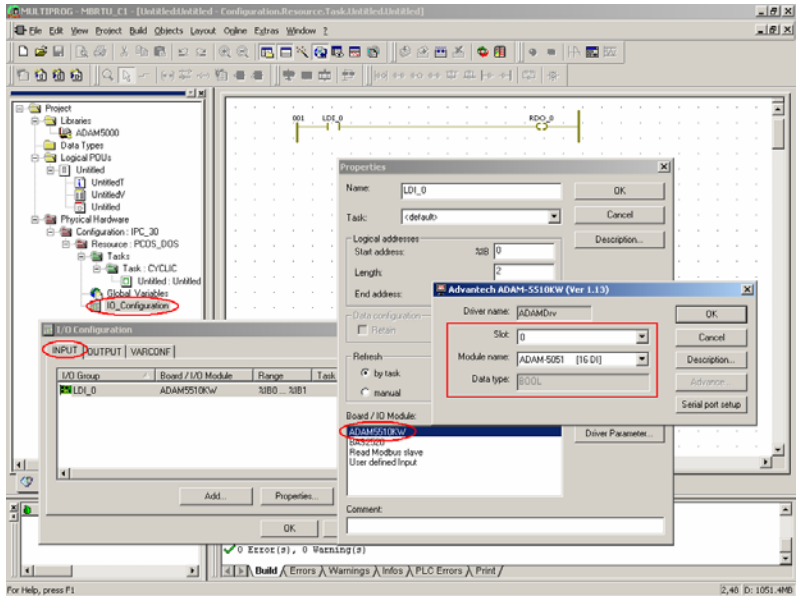

2. Configure ADAM-4056S DO bit 0 in Multiprog.

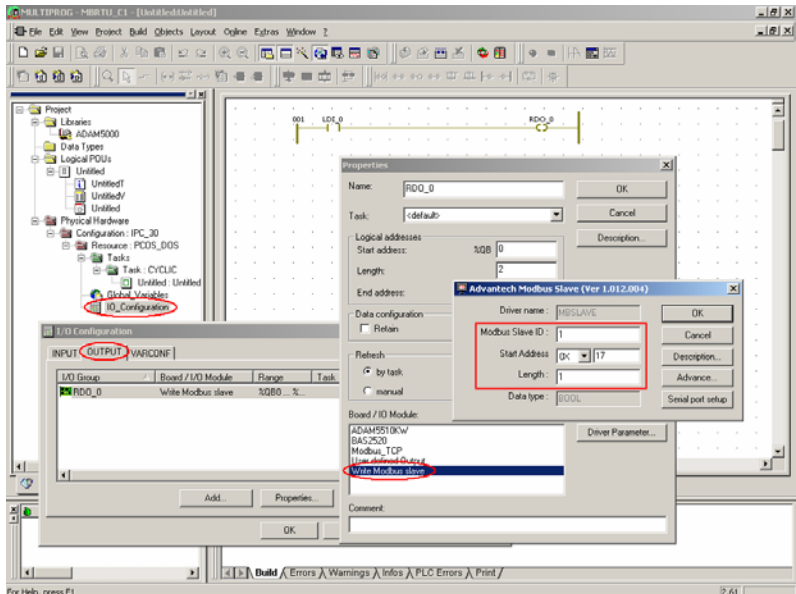

Chapter 5 Modbus Functions

- Run the project and check the status of ADAM-5051D DI bit 0 and ADAM-4056S DO bit 0.

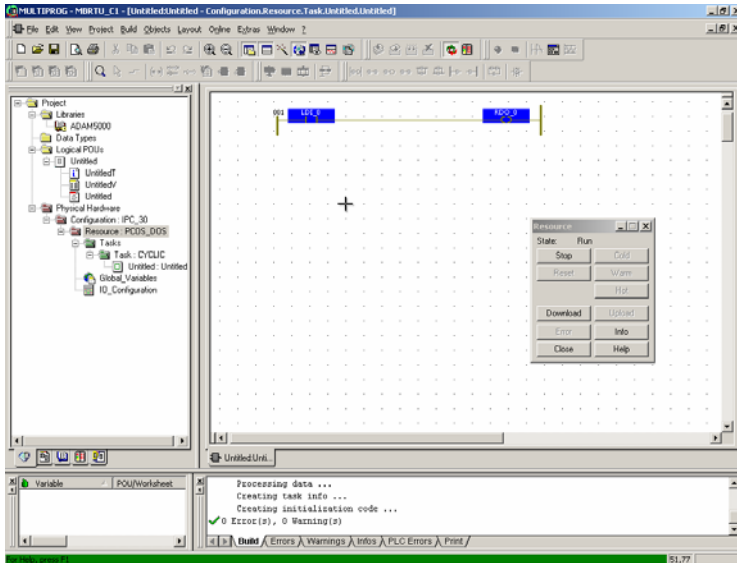

- Turn on ADAM-5051D DI bit 0 and check the status of ADAM-4056S DO bit 0 is turned on correctly.

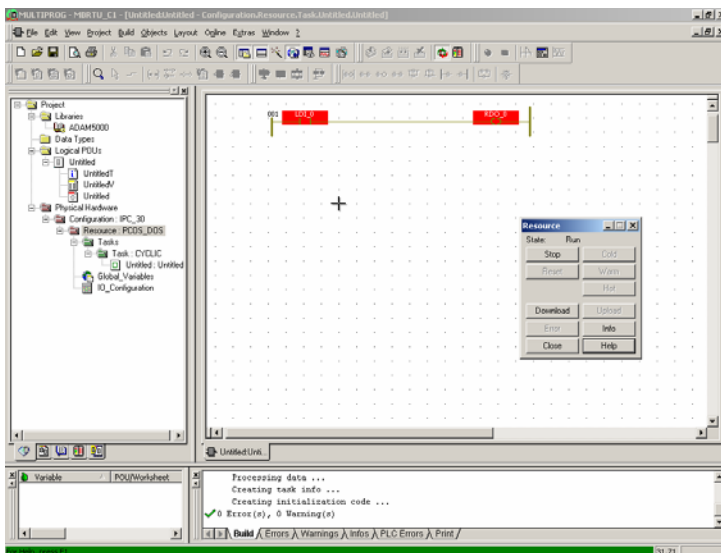

5.3 Modbus/RTU Slave Function

ADAM-5510KW Series Controller supports Modbus/RTU slave function for connecting to HMI/SCADA software or other Modbus/RTU master devices. The Modbus/RTU slave function is supported by COM1 or COM2 of ADAM-5510KW Series Controller. The DIP Switch setting is as following.

SW6	COM Selection	SW7	SW8	Mode Selection / Baud Rate
ON	COM1/RS-232	OFF	OFF	Modbus Protocol / 9600 bps
	COM2/RS-485			Multiprog Protocol / 19200 bps
OFF	COM2/RS-485	OFF	OFF	Modbus Mode / 9600 bps
	COM1/RS-232			Multiprog Protocol / 19200 bps
ON	COM1/RS-232	ON	OFF	Modbus Mode / 19200 bps
	COM2/RS-485			Multiprog Protocol / 19200 bps
OFF	COM2/RS-485	ON	OFF	Modbus Mode / 19200 bps
	COM1/RS-232			Multiprog Protocol / 19200 bps
ON	COM1/RS-232	OFF	ON	Modbus Mode / 38400 bps
	COM2/RS-485			Multiprog Protocol / 19200 bps
OFF	COM2/RS-485	OFF	ON	Modbus Mode / 38400 bps
	COM1/RS-232			Multiprog Protocol / 19200 bps

For example, following setting will configure Modbus/RTU Slave function via COM1/RS-232 port.

SW6	COM Selection	SW7	SW8	Mode Selection / Baud Rate
ON	COM1/RS-232	OFF	OFF	Modbus Protocol / 9600 bps

1. Click "Serial port setting" to configure COM1 or COM2



Chapter 5 Modbus Functions

2. Select “NOPARITY,8,1” and click “OK” to finish all the settings.

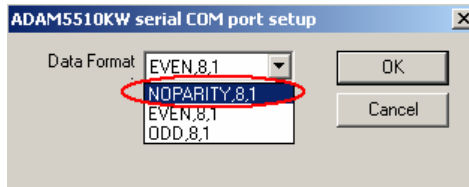

Note: Please be sure to press the “OK” button to save all the settings as configuration INI, even the default value must do this.

Please refer to section 2.3.3.2 for Modbus/RTU Slave Wiring

5.3.1 Modbus Address Mapping for local I/O points

SCADA/HMI software can directly access the I/O points of ADAM-5510KW Series Controller by Modbus/RTU slave function. The Modbus Address mapping table is as following.

Note: Only read functions of Modbus 1X and 3X commands are supported.

For Digital Input/Output Module:

	Slot 0	Slot 1	Slot 2	Slot 3	Slot 4	Slot 5	Slot 6	Slot 7
Bit 0	00001	00017	00033	00049	00065	00081	00097	00113
Bit 1	00002	00018	00034	00050	00066	00082	00098	00114
Bit 2	00003	00019	00035	00051	00067	00083	00099	00115
Bit 3	00004	00020	00036	00052	00068	00084	00100	00116
Bit 4	00005	00021	00037	00053	00069	00085	00101	00117
Bit 5	00006	00022	00038	00054	00070	00086	00102	00118
Bit 6	00007	00023	00039	00055	00071	00087	00103	00119
Bit 7	00008	00024	00040	00056	00072	00088	00104	00120
Bit 8	00009	00025	00041	00057	00073	00089	00105	00121
Bit 9	00010	00026	00042	00058	00074	00090	00106	00122
Bit 10	00011	00027	00043	00059	00075	00091	00107	00123
Bit 11	00012	00028	00044	00060	00076	00092	00108	00124
Bit 12	00013	00029	00045	00061	00077	00093	00109	00125
Bit 13	00014	00030	00046	00062	00078	00094	00110	00126
Bit 14	00015	00031	00047	00063	00079	00095	00111	00127
Bit 15	00016	00032	00048	00064	00080	00096	00112	00128

For Analog Input/Output(WORD) and Counter(DWORD) Module:

	Slot 0	Slot 1	Slot 2	Slot 3	Slot 4	Slot 5	Slot 6	Slot 7
CH0	40001	40009	40017	40025	40033	40041	40049	40057
CH1	40002	40010	40018	40026	40034	40042	40050	40058
CH2	40003	40011	40019	40027	40035	40043	40051	40059
CH3	40004	40012	40020	40028	40036	40044	40052	40060
CH4	40005	40013	40021	40029	40037	40045	40053	40061
CH5	40006	40014	40022	40030	40038	40046	40054	40062
CH6	40007	40015	40023	40031	40039	40047	40055	40063
CH7	40008	40016	40024	40032	40040	40048	40056	40064

5.3.2 Modbus Address Mapping

ADAM-5510KW Series Controller reserves 16K Bytes memory space for Modbus function. The memory block can store user's data and exchange the data through Modbus protocol. The unit in Modbus 4X registers is Word so there are totally 8K Words available.

The Modbus address is defined from 42001 to 49999. In order to exchange the data through Modbus, users need to move the data onto this memory block by setting the memory address in "I/O Address" field manually. The memory address of this memory block is defined from MW3.0 to MW3.15996. The mapping table of I/O Address and

Chapter 5 Modbus Functions

Modbus Address is as following table.

I/O Address	Modbus Address
%MW3.0	42001
%MW3.2	42002
%MW3.4	42003
...	

Since unit of MW3.0 is Byte, users need to map the I/O Address and Modbus Address as following.

For Bool data type:

	I/O Address	Modbus Address	Length
Data 1	MW3.0.0	02001	1 Bit
Data 2	MW3.0.1	02002	1 Bit
Data 3	MW3.0.2	02003	1 Bit

For Byte and Word data type:

	I/O Address	Modbus Address	Length
Data 1	MW3.0+ MW3.1	42001	2 Bytes
Data 2	MW3.2+MW3.3	42002	2 Bytes
Data 3	MW3.4+MW3.5	42003	2 Bytes

For Dword and Real data type:

	I/O Address	Modbus Address	Length
Data 1	MW3.0+MW3.1+MW3.2+MW3.3	42001+42002	4 Bytes
Data 2	MW3.4+MW3.5+MW3.6+MW3.7	42003+42004	4 Bytes
Data 3	MW3.8+MW3.9+MW3.10+MW3.11	42005+42006	4 Bytes

Example:

ADAM-5510KW: Modbus/RTU Slave Function via COM1/RS-232

Slot 3: ADAM-5017

Channel 0: +1.51V battery input

1. Configure ADAM-5017 CH0 in Multiprog.

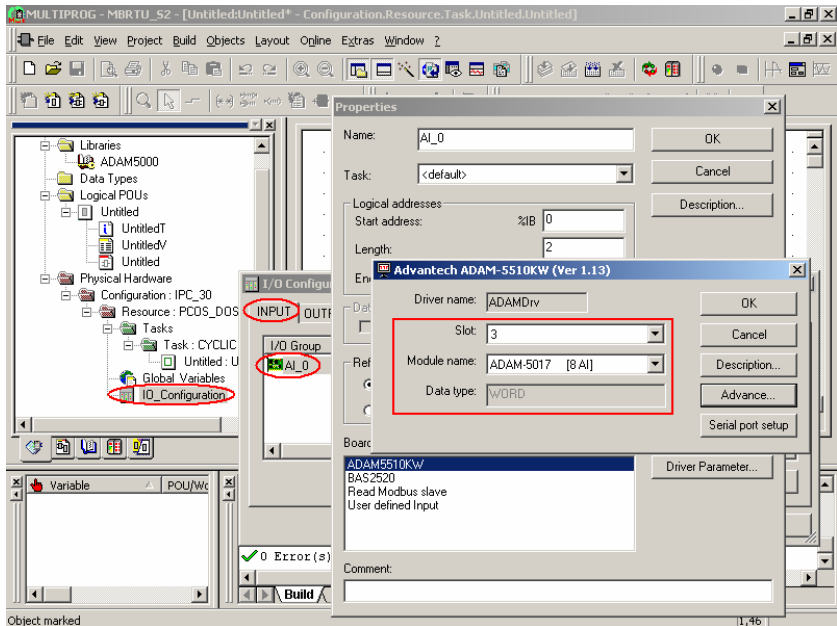

Chapter 5 Modbus Functions

2. Add Move function block and configure the input.

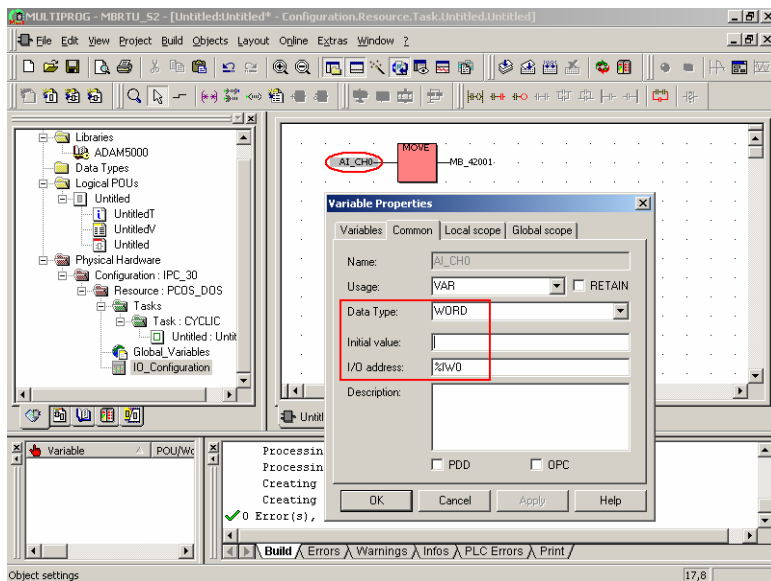

3. Configure the output.

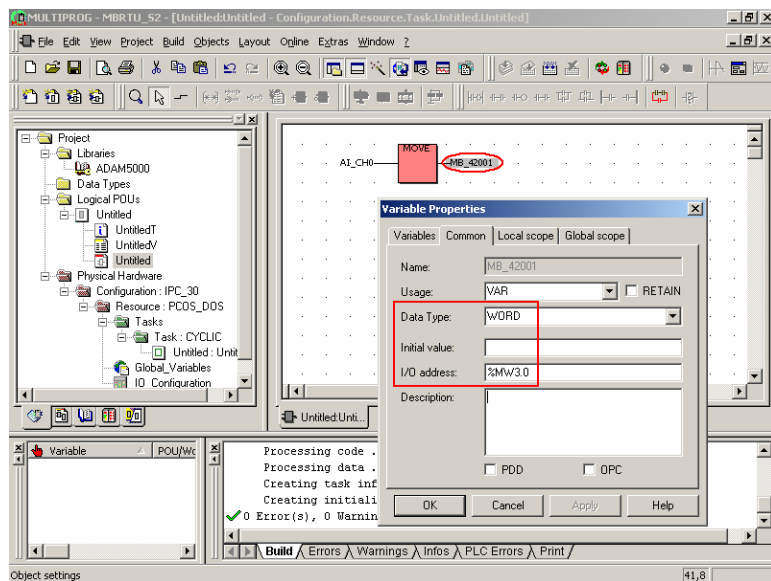

4. Run the project and check the data movement.

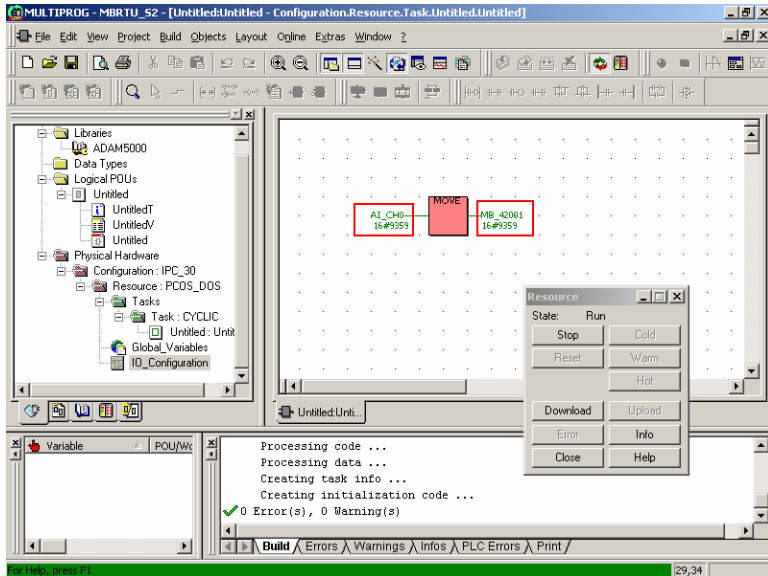

5. Check the Modbus/RTU Slave function by Modscan test utility.

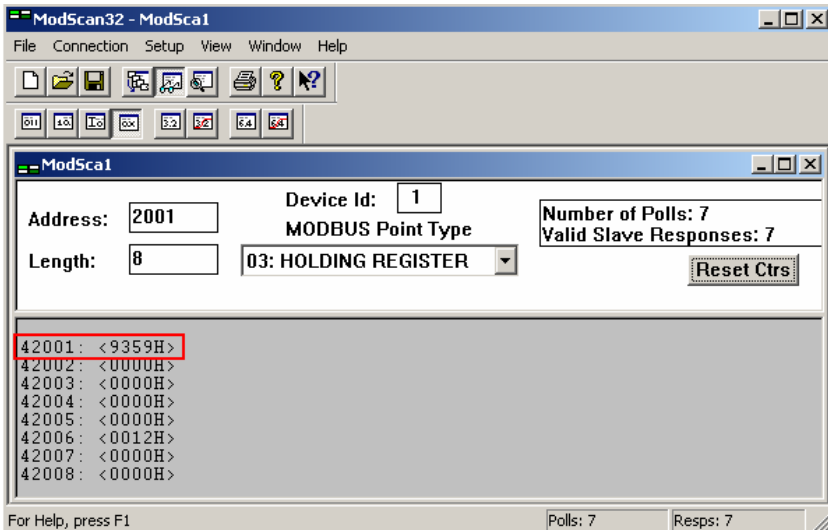

Chapter 5 Modbus Functions

5.4 Modbus/TCP Server Function

ADAM-5510KW Series Controller supports Modbus/TCP server function for connecting to HMI/SCADA software. The Modbus/TCP server function is supported by using Ethernet port of ADAM-5510KW Series Controller.

SCADA/HMI software can directly access the I/O points of ADAM-5510KW Series Controller by Modbus/TCP server function. Please refer to section 5.3.1 about the Modbus Address mapping table.

The reserved 16K Bytes memory space for Modbus function also supports Modbus/TCP server function for exchanging data with other Modbus devices. Users need to follow the same procedures in section 5.3.2. The only difference between Modbus/RTU slave function and Modbus/TCP server function is Modbus/RTU via serial port and Modbus/TCP via Ethernet port.

5.5 Modbus/TCP Client Function

The Modbus/TCP client function can connect to Modbus devices with Modbus/TCP server function, for example, ADAM-5000/TCP and ADAM-6000 series I/O modules.

Following example can show how to connect to ADAM-6051 by Modbus/TCP client function.

ADAM-6051 settings:
IP address: 192.168.1.5

ADAM-5510KW Series Controller settings:
Slot 1: ADAM-5056D
IP address: 192.168.1.4

Multiprog settings:
LDO_0: ADAM-5056D DO bit 0
RDI_0: ADAM-6051 DI bit 0
Board I/O Modules: Modbus_TCP
ADAM-6051 DO channel's Modbus start address: 00001

1. Configure ADAM-6051 DI bit 0 in Multiprog.

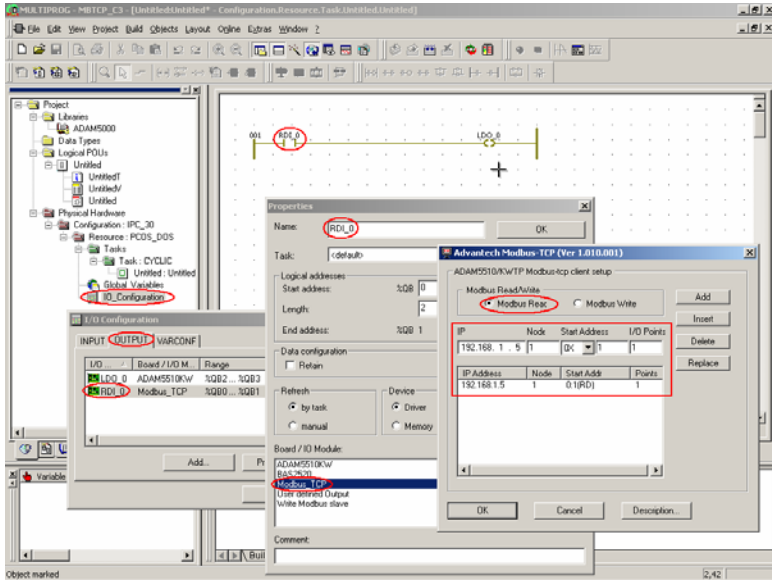

2. Configure ADAM-5056 DO bit 0 in Multiprog.

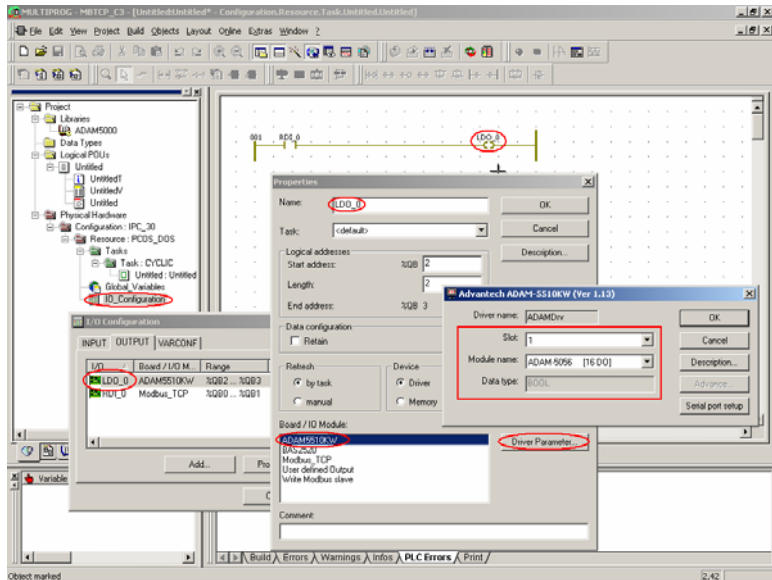

Chapter 5 Modbus Functions

3. Run the project and check the status of ADAM-5056D DO bit 0 and ADAM-6051 DI bit 0.

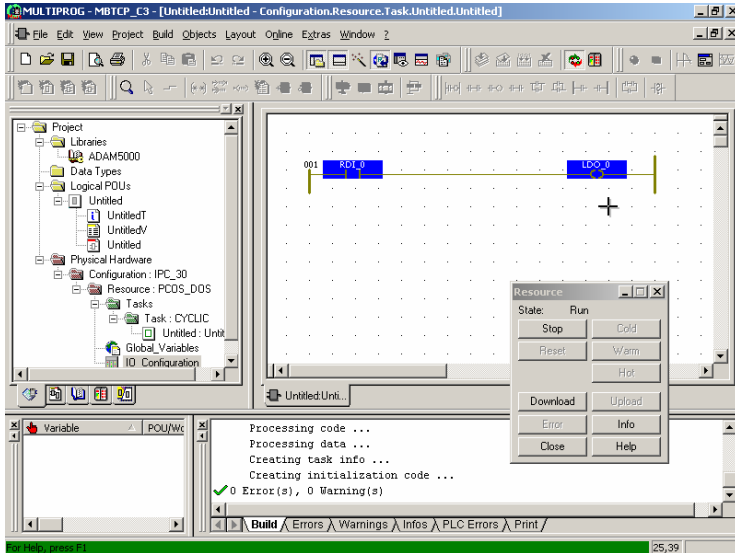

4. Turn on ADAM-6051 DI bit 0 and check the status of ADAM-5056D DO bit 0 is turned on correctly.

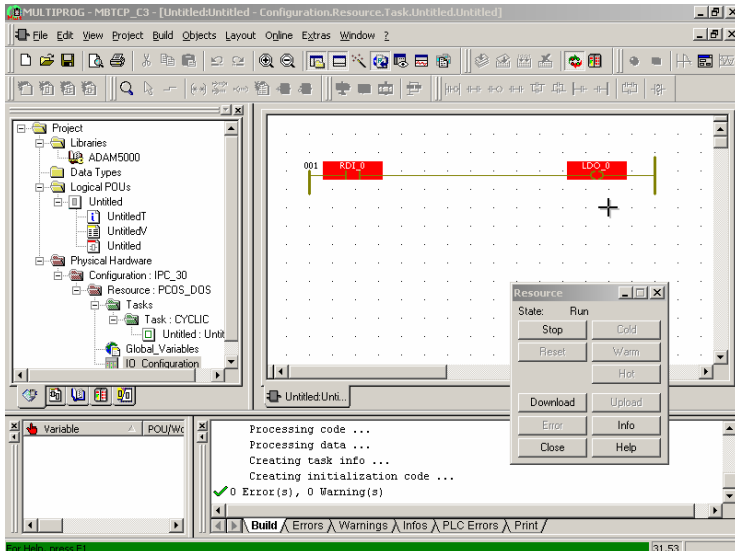

6

ADAM-5000 Function Blocks

Chapter 6 ADAM-5000 Function Blocks

In this chapter, some examples are shown for demonstrating how to use the ADAM-5000 function blocks. The ADAM-5000 function blocks can be accessed as following.

1. Click View/Edit Wizard.

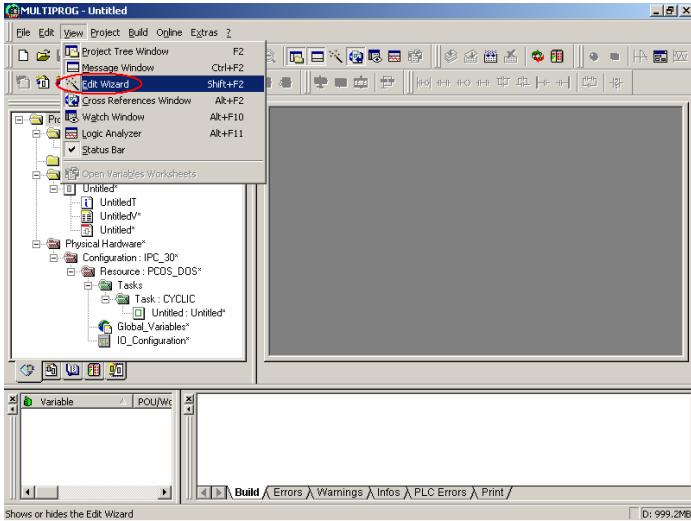

2. Click ADAM5000 item.

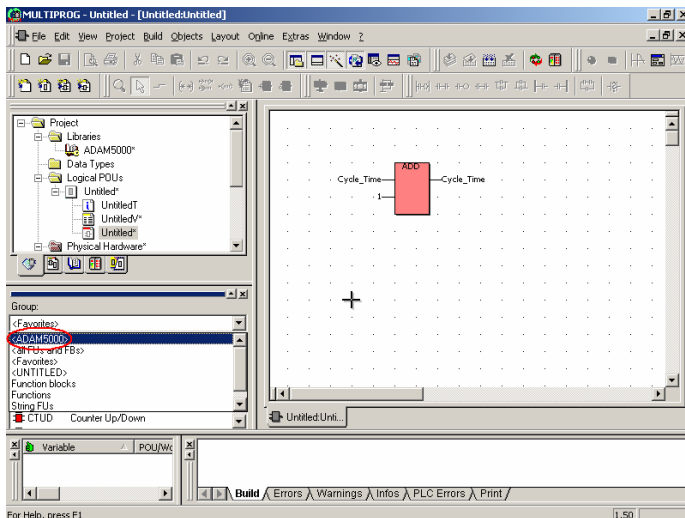

3. Supported function blocks are as following picture. The function blocks include I/O Function Blocks, Move Function Blocks for “Data to MB42XXX” and “MB42XXX to Data”, Calendar Function Block, Scale Function Blocks and Max-Min-Average Function Block.

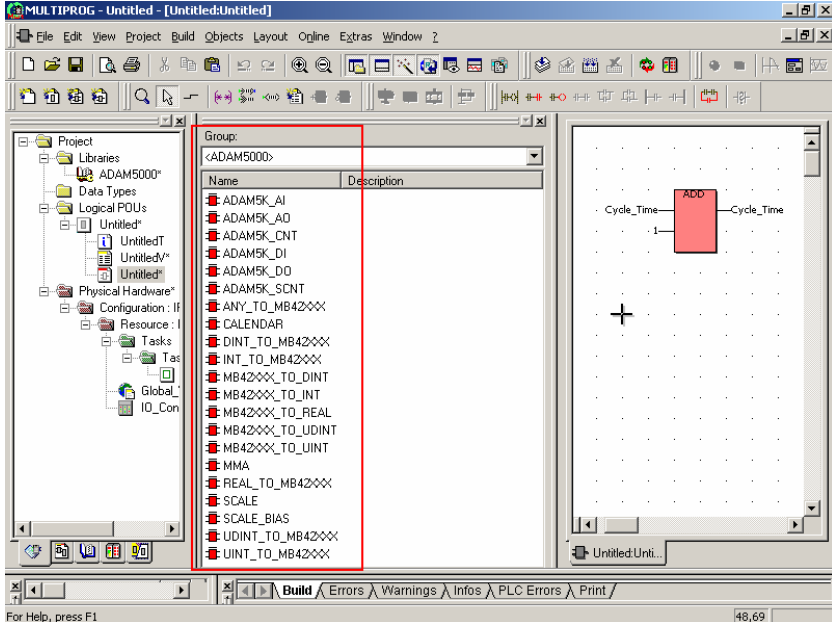

Chapter 6 ADAM-5000 Function Blocks

6.1 Example of AI Function Block

This example uses AI function block to read the voltage of battery and move the reading to Modbus Address 42001.

ADAM-5510KW Series Controller settings:

Slot 3: ADAM-5017

Channel 0: +1.51V battery input

1. Add AI Function Block and set EN input pin to BOOL type value 1.

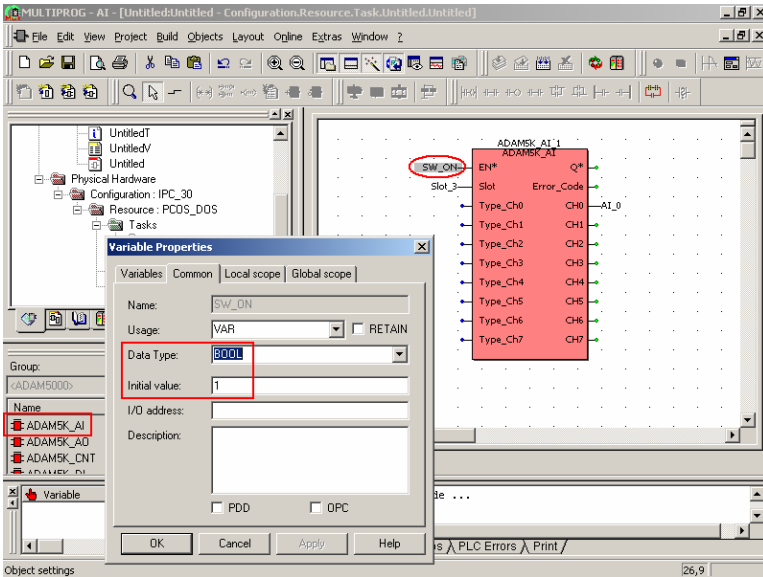

2. Set Slot input pin to INT type value 3.

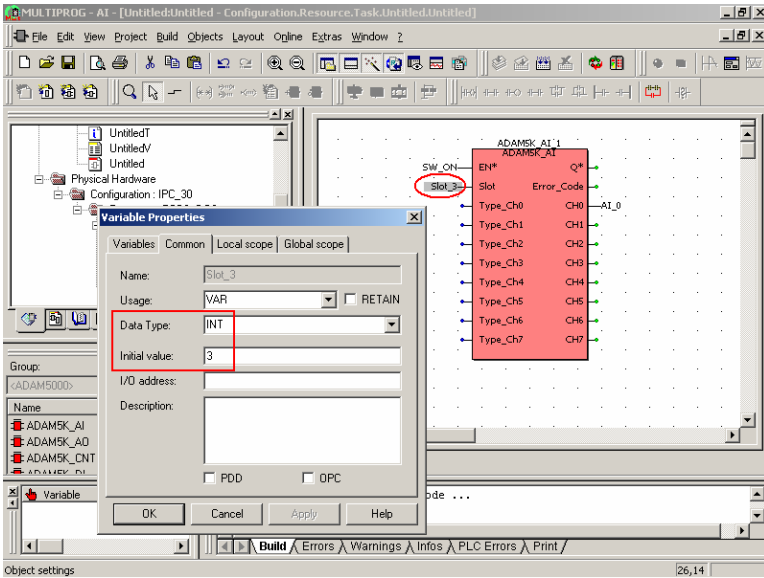

3. Set CH0 output pin to UINT type I/O address %MW3.0.

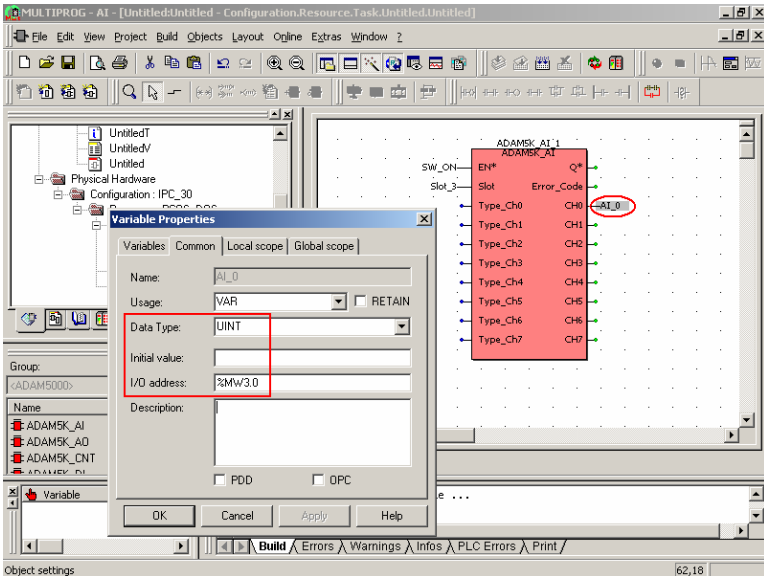

Chapter 6 ADAM-5000 Function Blocks

4. Run the project and check the CH0 value is correct.

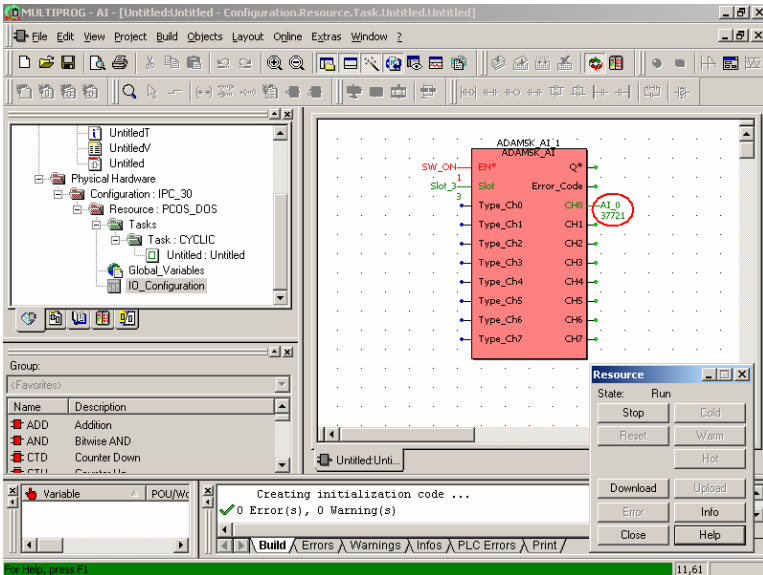

5. Run Modscan utility to read the value of Modbus address 42001 and check the value is correct.

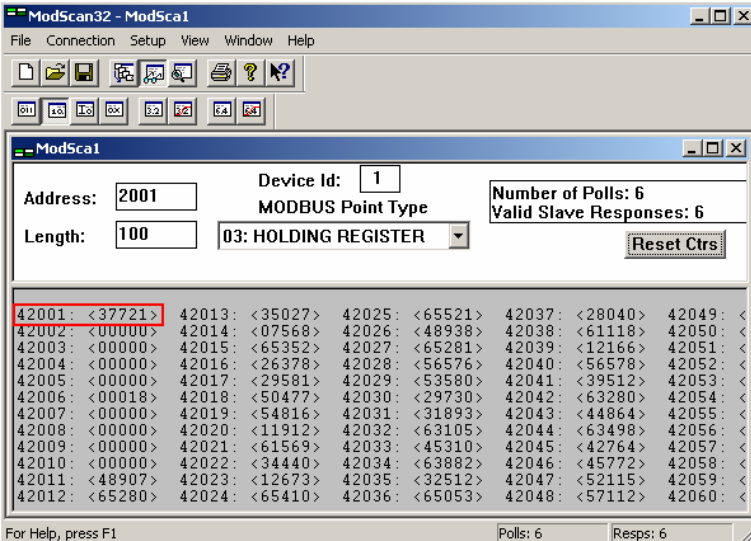

6.2 Example of AO Function Block

This example uses AO function block to set +10V output to CH0.

ADAM-5510KW Series Controller settings:

Slot 2: ADAM-5024

Channel 0: +10V output

Input range: 0~+10V

1. Add AO Function Block and set EN input pin to BOOL type value 1.

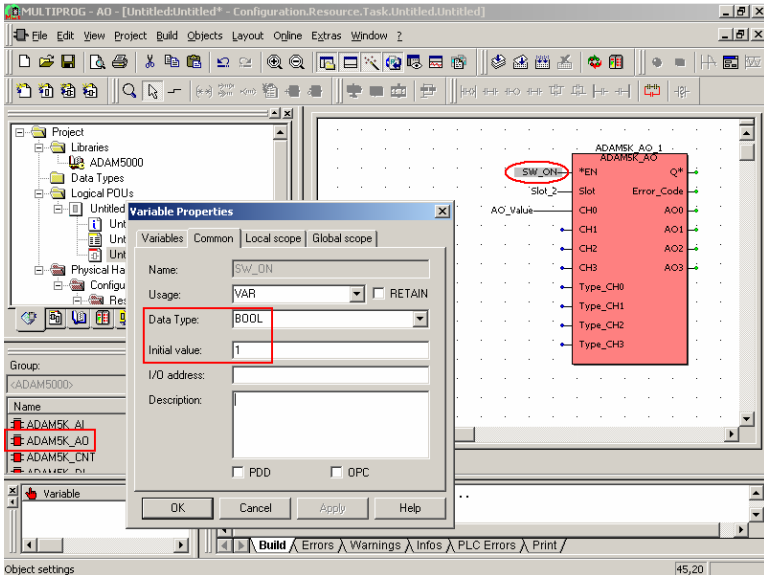

Chapter 6 ADAM-5000 Function Blocks

2. Set Slot input pin to INT type value 2.

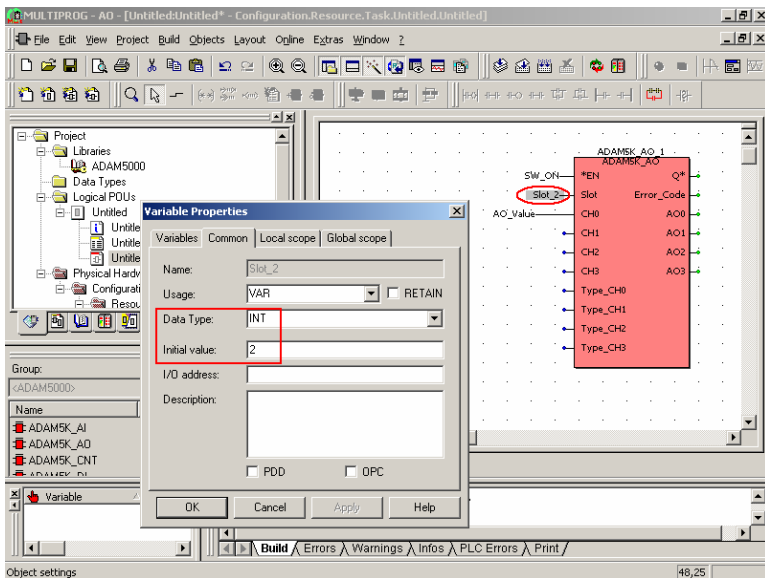

3. Set AO output value to 4095 for +10V.

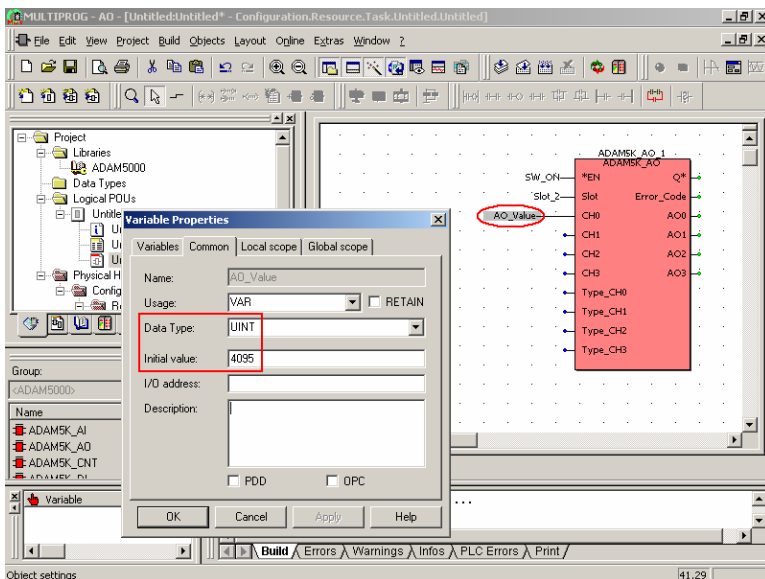

4. Run the project and check the CH0 output is correct.

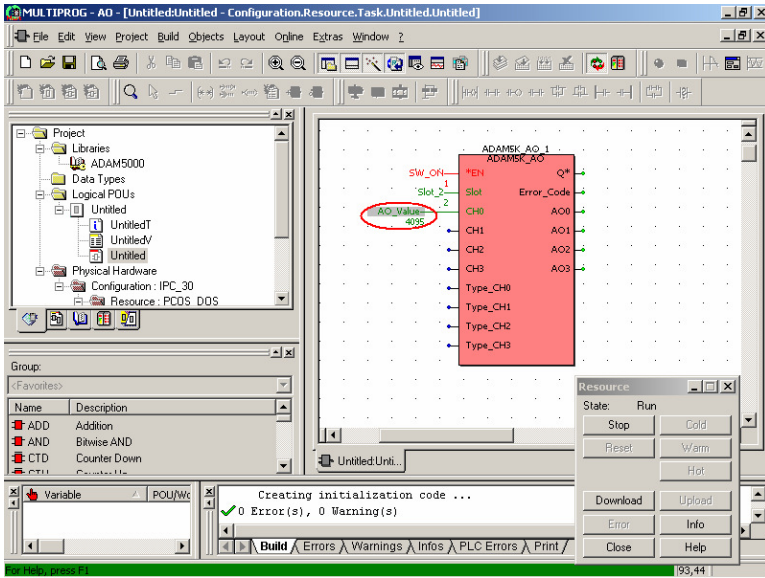

Chapter 6 ADAM-5000 Function Blocks

6.3 Example of DI/DO Function Block

This example uses DI/DO function blocks and DO bit 0 will follow the status of DI bit 0.

ADAM-5510KW Series Controller settings:

Slot 0: ADAM-5051D

Slot 1: ADAM-5056D

Connection: DI bit 0 to DO bit 0.

1. Add DI and DO Function Blocks and set EN input pin to BOOL type value 1.

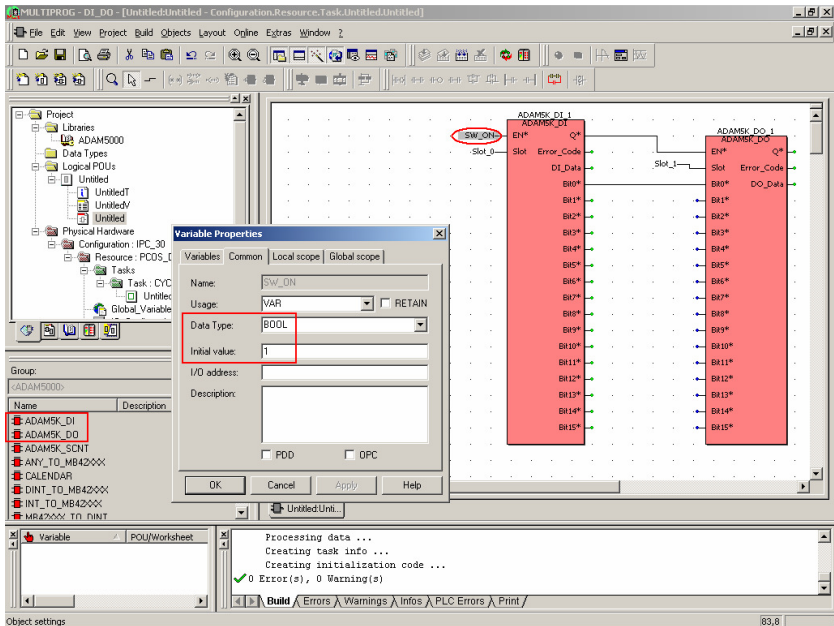

2. Set Slot input pin to INT type value 0.

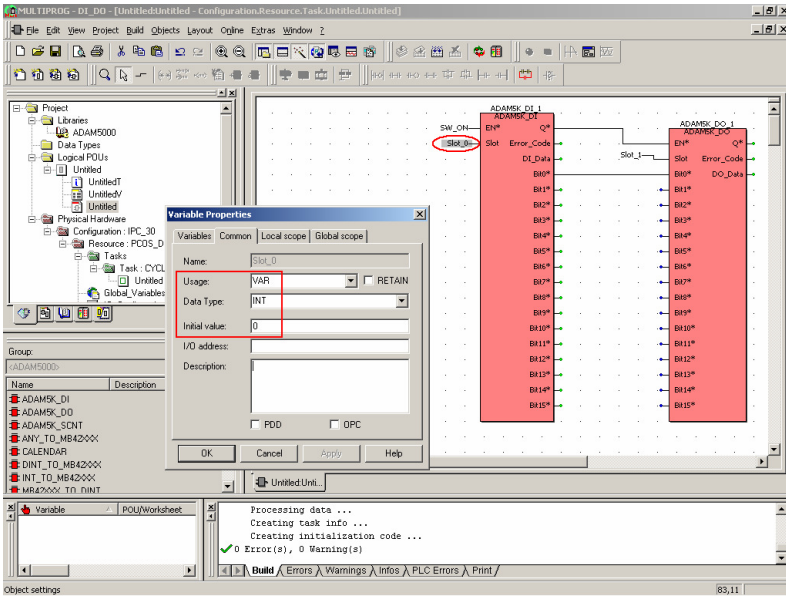

3. Set Slot input pin to INT type value 1.

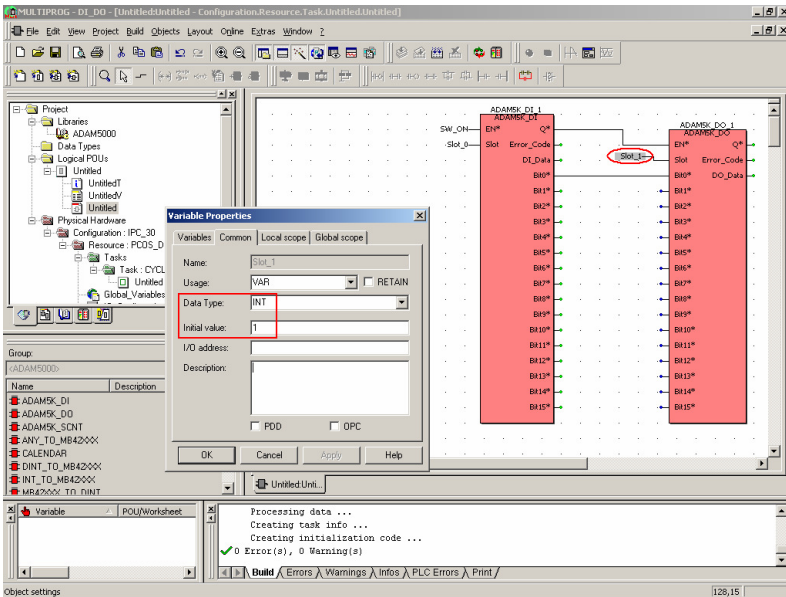

Chapter 6 ADAM-5000 Function Blocks

4. Connect Q output pin of DI block to EN input pin of DO block. DI block bit 0 is connected to DO block bit 0.

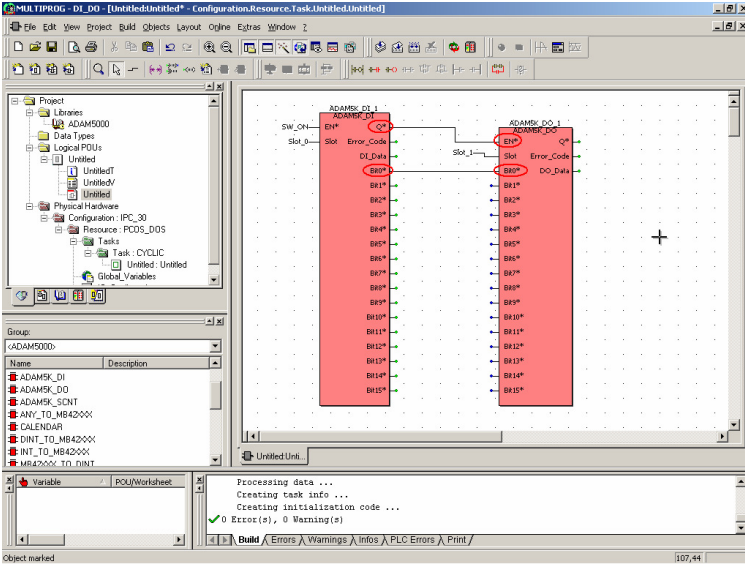

5. Run the project and check the status of DO bit 0 is correct.

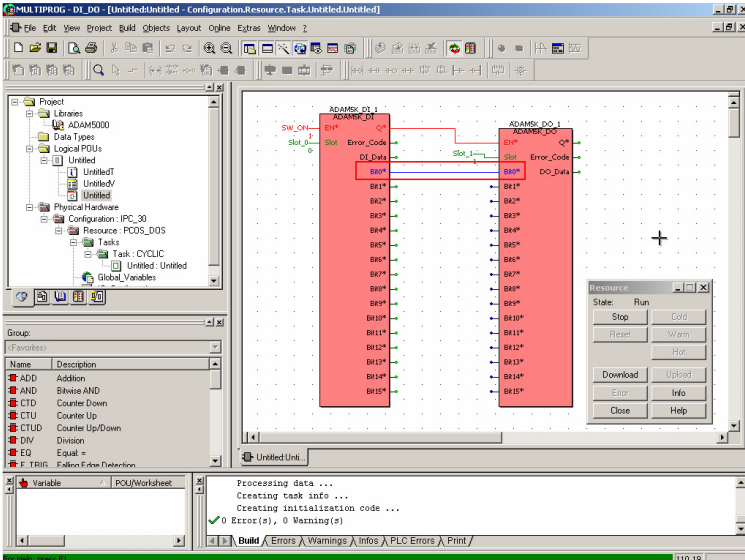

6. Change the status of DI bit 0 and check the status of DO bit 0 is correct.

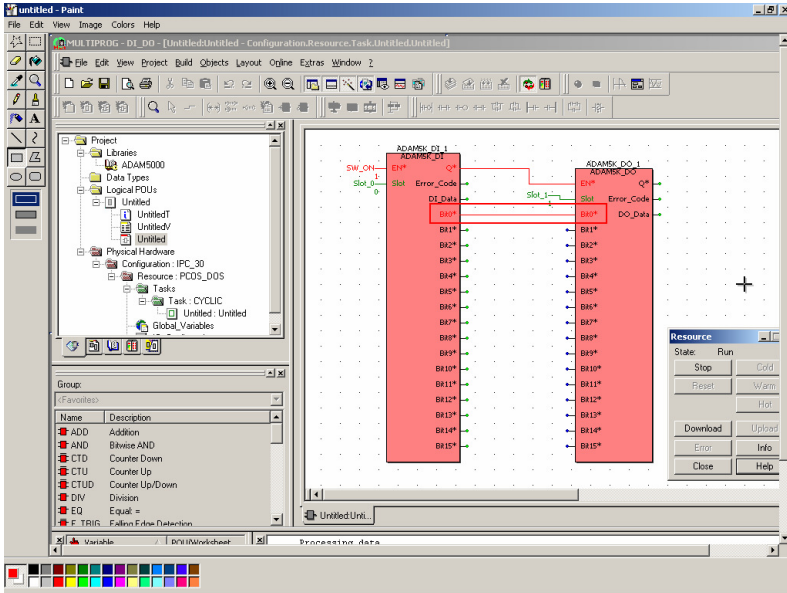

Chapter 6 ADAM-5000 Function Blocks

6.4 Example of Move Function Block “INT to MB42XXX”.

This example uses INT_TO_MB42XXX function block to transfer DI bit 0 of ADAM-5051D to Modbus Address 42001.

ADAM-5510KW Series Controller settings:

Slot 0: ADAM-5051D

Slot 1: ADAM-5056D

1. Add INT_TO_MB42XXX function block and BOOL_TO_INT function block onto DIO demo project. Set EN input as BOOL#1.

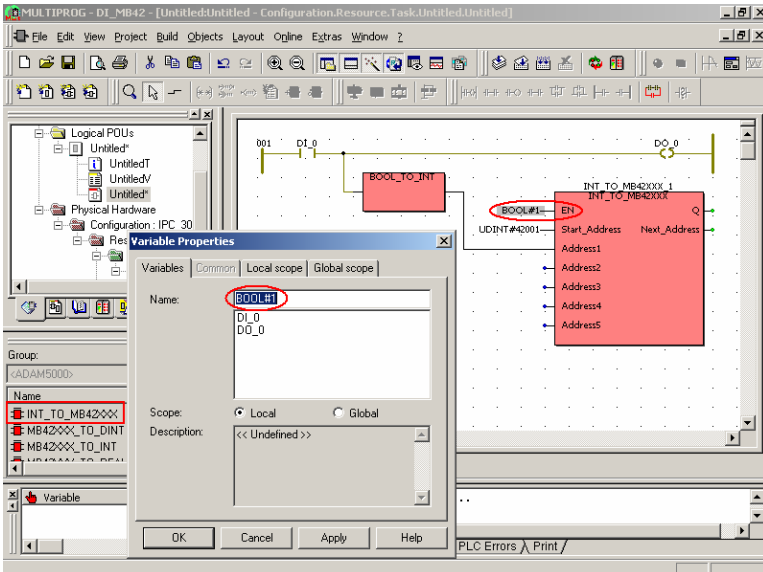

2. Set Start_Address as UDINT#42001.

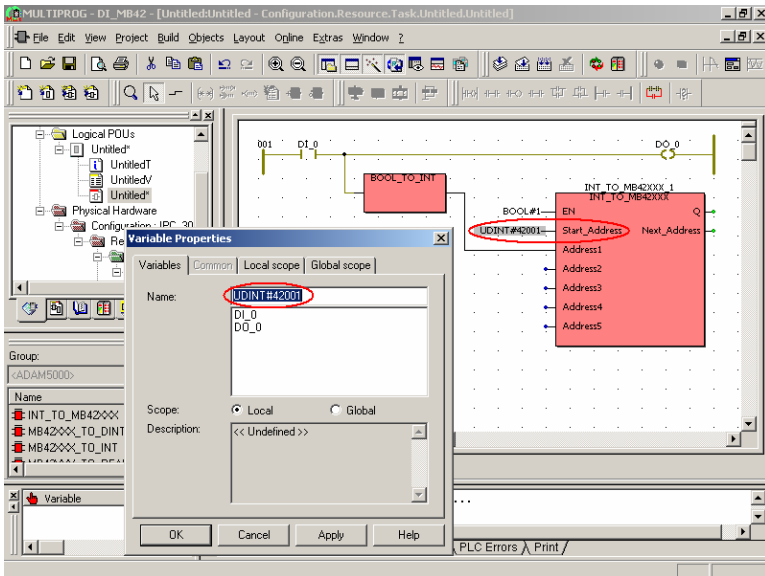

3. Run the project and check the value of Address1 is correct.

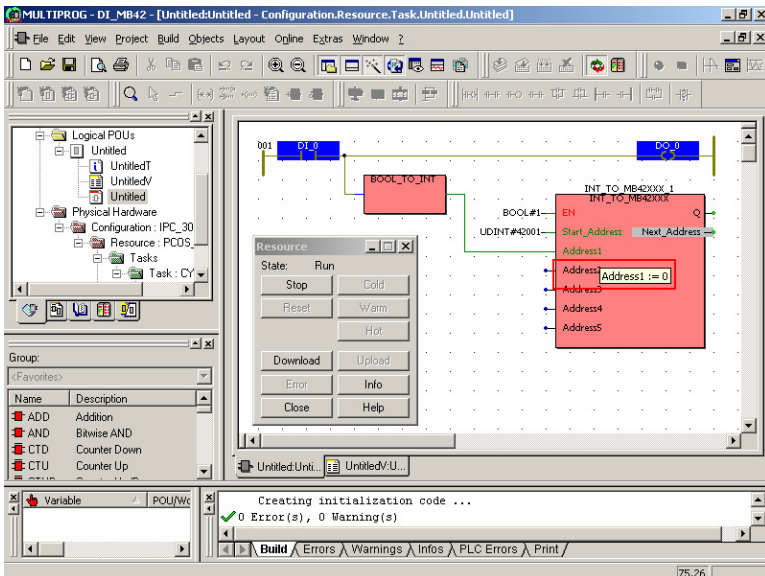

Chapter 6 ADAM-5000 Function Blocks

4. Run Modscan and check the value of Modbus Address 42001.

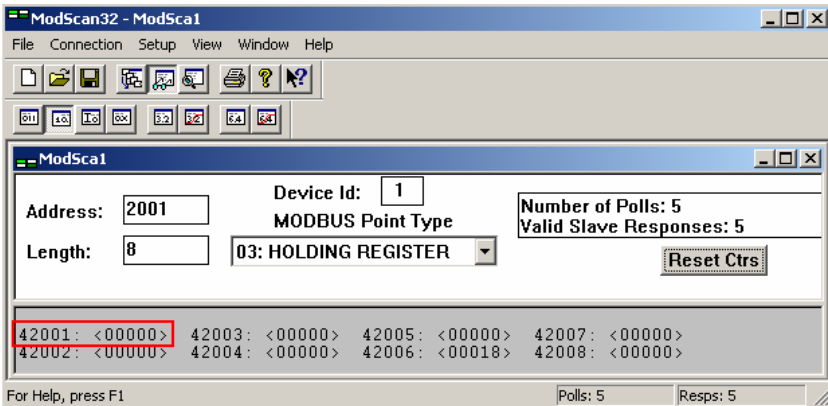

5. Check the value of Modbus Address 02001.

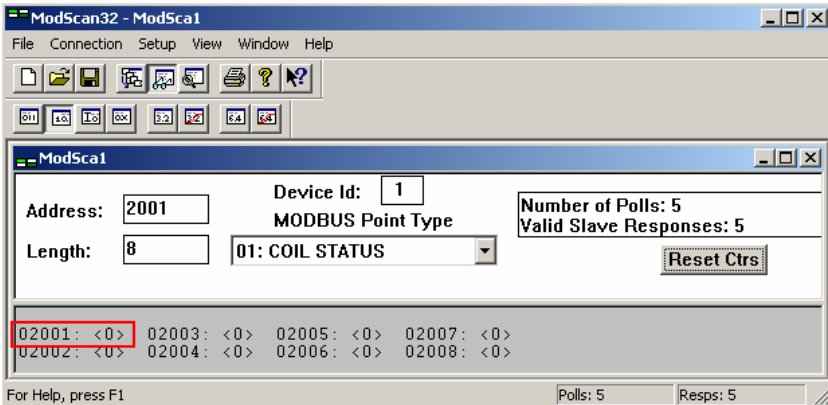

Chapter 6 ADAM-5000 Function Blocks

6. Change the state of DI bit 0 to ON and check the value of Address1 is correct.

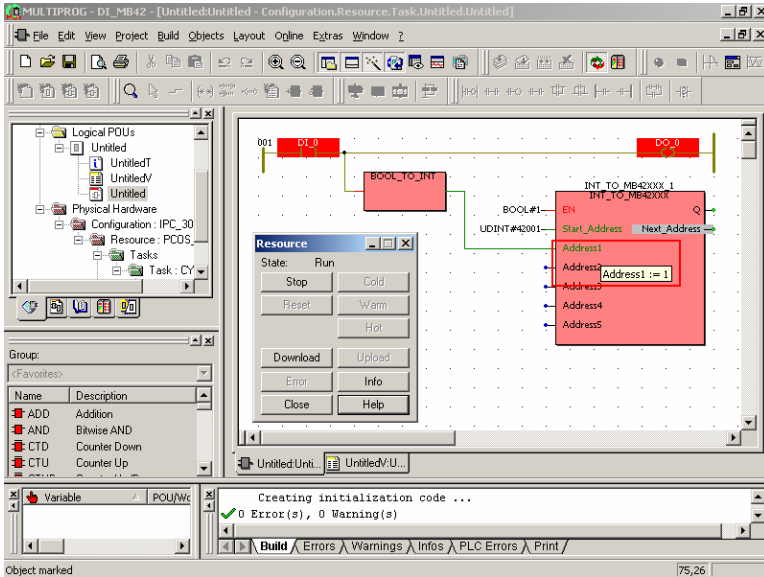

7. Check the value of Modbus Address 42001.

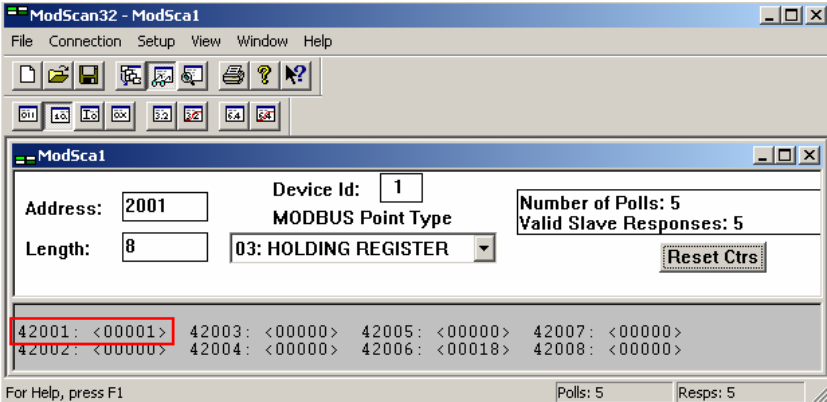

Chapter 6 ADAM-5000 Function Blocks

8. Check the value of Modbus Address 02001.

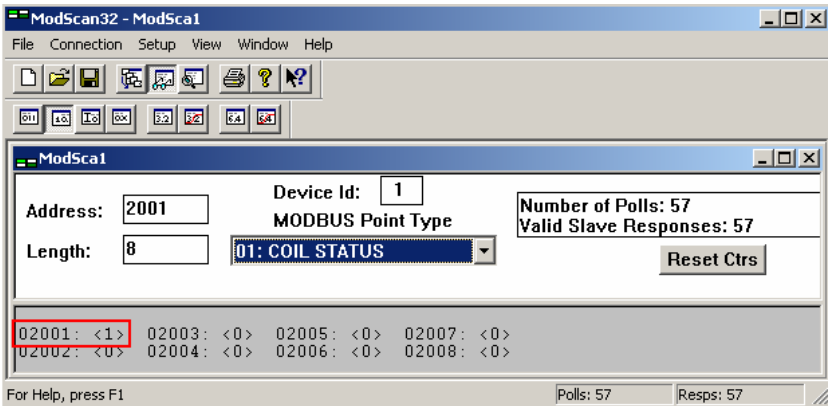

6.5 Example of MMA, SCALE_BIAS and SCALE function blocks.

This example shows how to use MMA, SCALE and SCALE_BIAS function blocks.

MMA inputs:

A=1.0
B=3.0
C=5.0
D=7.0
NofInput=4

MMA outputs:

MAX=7.0
MIN=1.0
AVG=4.0
SUM=16.0
STD=2.236

SCALE_BIAS inputs:

X=AVG=4.0 (from MMA)
K=2.0
B=1.0

SCALE_BIAS outputs:

Y=9.0

Formula: $Y=KX+B$

SCALE inputs:

RAW=SUM=16.0 (from MMA)
IN_High=18.0
IN_Low=14.0
OUT_High=4.0
OUT_Low=2.0

SCALE outputs:

Result=3.0

Formula:

$(\text{Result}-\text{OUT_Low})/(\text{RAW}-\text{IN_Low})$
 $= (\text{OUT_High}-\text{OUT_Low})/(\text{IN_High}-\text{IN_Low})$

Chapter 6 ADAM-5000 Function Blocks

1. Add MMA, SCALE and SCALE_BIAS function blocks. Set the input values as above and make the connections as below.

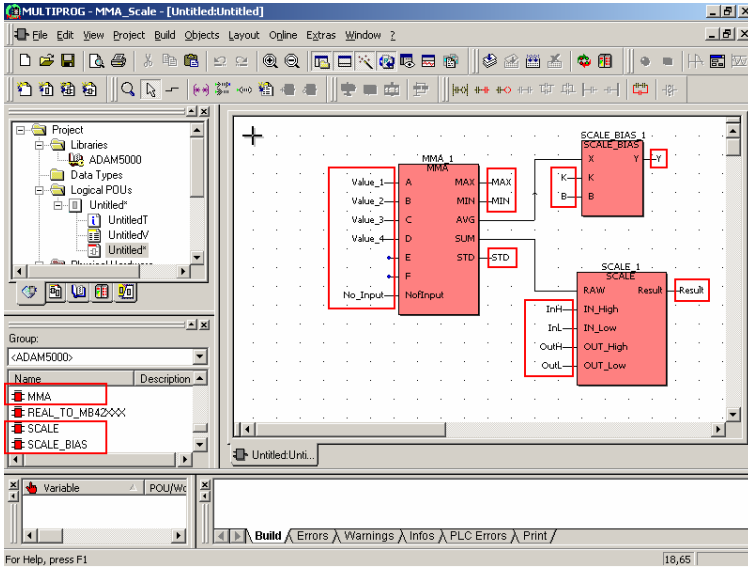

2. Run the project and check the output values.

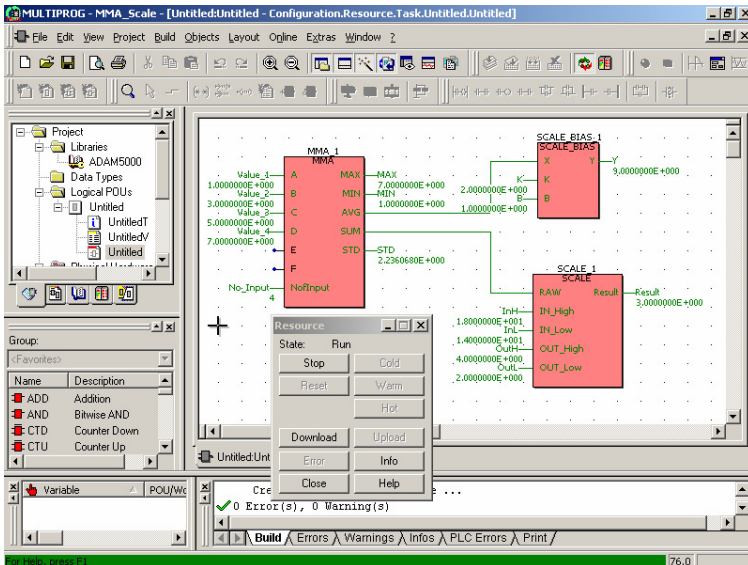

6.6 Example of CALENDAR Function Block

This example uses CALENDAR function block to stamp the time of DI event.

ADAM-5510KW Series Controller settings:

Slot 0: ADAM-5051D

Slot 1: ADAM-5056D

1. Add CALENDAR, R_TRIG and INT_TO_MB42XXX function blocks onto DIO demo project. Make the connections as below.

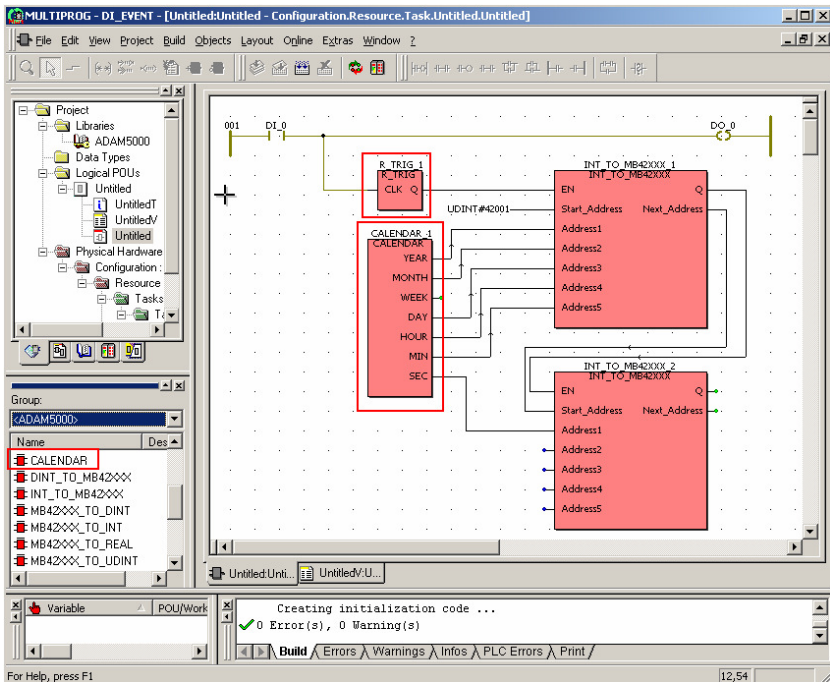

Chapter 6 ADAM-5000 Function Blocks

2. Run the project and trig the DI event. Check the time is recorded once.

The screenshot displays the MULTIPROG - DI_EVENT software interface. The main workspace shows a ladder logic diagram with the following components:

- DI_0**: A red rectangular input symbol connected to the **R_TRIG 1** block.
- R_TRIG 1**: A red rectangular block with a **CLK** input and a **Q** output. The **Q** output is connected to the **EN** input of the **INT TO MB42XXX 1** block.
- UDINT#42001**: A text label connected to the **Start_Address** input of the **INT TO MB42XXX 1** block.
- CALENDAR-1**: A red rectangular block with inputs for **YEAR**, **MONTH**, **WEEK**, **DAY**, **HOUR**, **MIN**, and **SEC**. Its outputs are connected to the **Address1** through **Address5** inputs of the **INT TO MB42XXX 1** block.
- INT TO MB42XXX 1**: A red rectangular block with **EN** and **Q** inputs, and **Start_Address**, **Next_Address**, and **Address1** through **Address5** outputs.
- INT TO MB42XXX 2**: A red rectangular block with **EN** and **Q** inputs, and **Start_Address**, **Next_Address**, and **Address1** through **Address5** outputs. It is connected to the **Next_Address** output of the **INT TO MB42XXX 1** block.
- DO_0**: A red rectangular output symbol connected to the **Q** output of the **INT TO MB42XXX 2** block.

A **Resource** dialog box is open in the foreground, showing the state of the **CALENDAR** resource. The **State** is **Run**. The dialog includes buttons for **Stop**, **Reset**, **Download**, **Error**, **Close**, **Cold**, **Warm**, **Upload**, **Info**, and **Help**.

The bottom status bar shows: **0 Error(s), 0 Warning(s)** and **Build** button.

3. Run Modscan utility and check the time stamp is correct at Modbus Address 42001 to 42006.

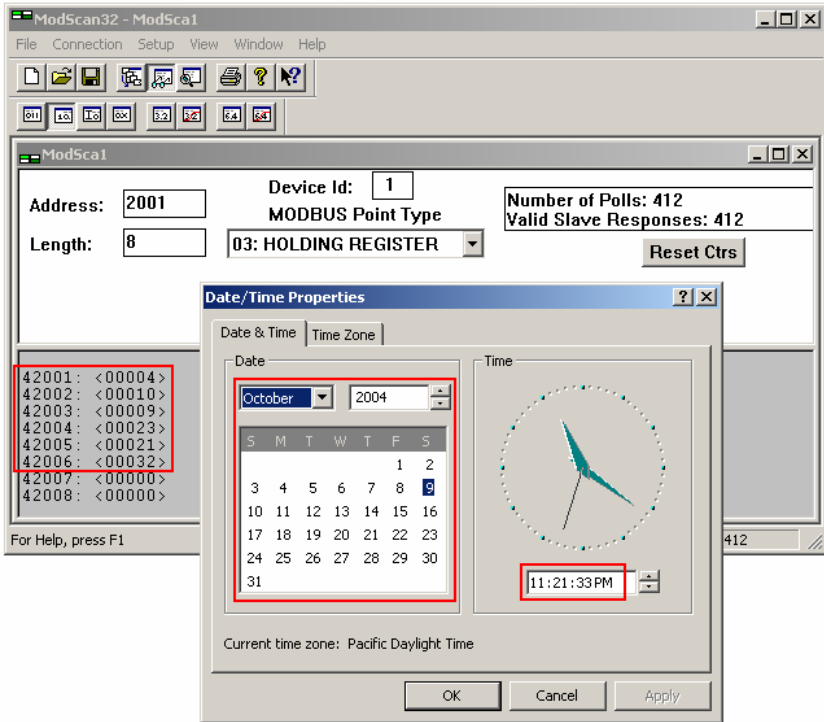

Chapter 6 ADAM-5000 Function Blocks

6.7 Example of Communication Function Block

Please open the example project “COMM_FB.zwt” via “KW-Software\Projects” directory. The guideline of this example is as following.

1. COM_FB: Communication Function Block

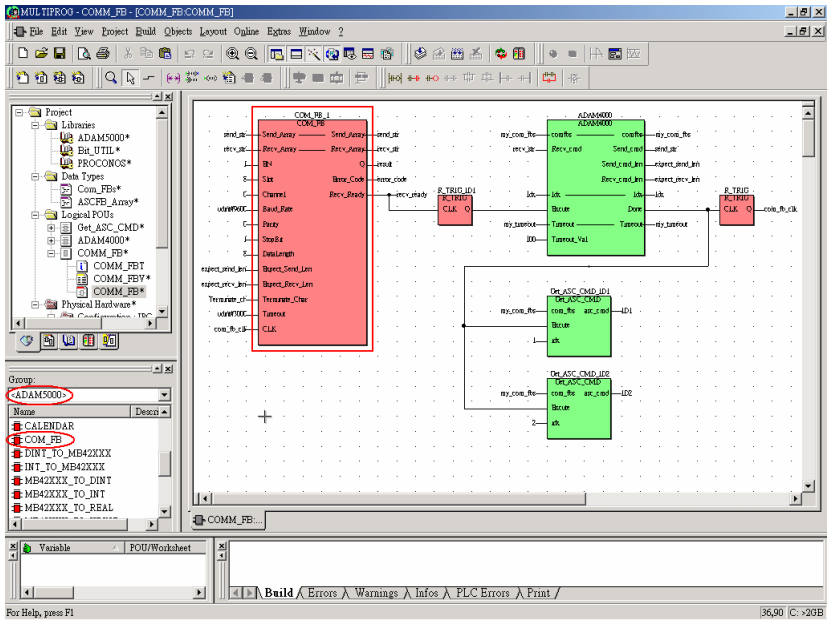

Chapter 6 ADAM-5000 Function Blocks

COM_FB Parameters

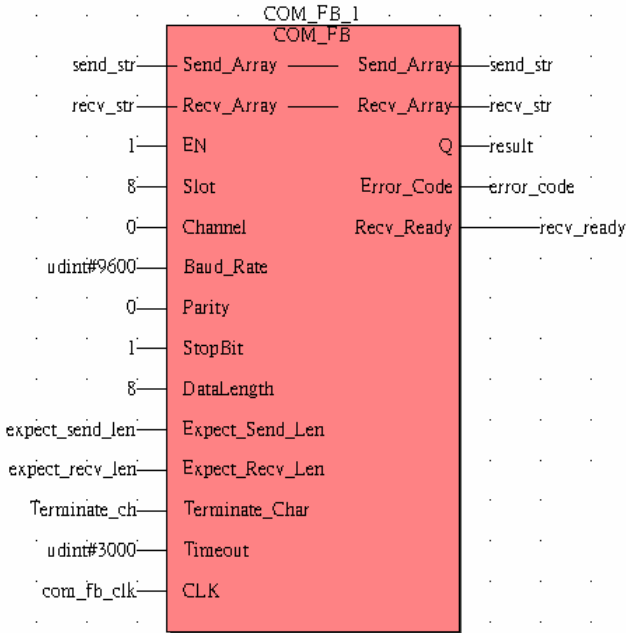

Send_Array: Byte Array for Command

Recv_Array: Byte Array for Response

EN: 1: enable; 0: disable

Slot: 0~7: ADAM-5510KW Series I/O slot number 0~7 for ADAM-5090
8: COM4

Channel: 0~3: ADAM-5090 Channel 0~3
0: COM4

Baud Rate: 1200, 2400, 4800, 9600, 19200, 38400, 57600, 115200 bps

Parity: 0: None

1: Even

2: Odd

Stop Bit: 1 or 2

Data Length: 7 or 8

Expect_Send_Len: Bytes Count for Command (max. 80 bytes)

Expect_Recv_Len: Bytes Count for Response (max. 80 bytes)

Terminate_Char: Terminate Character of ASCII Command

- Note:
1. The value of Terminate_Char is specified as 0 while sending binary command.
 2. The maximum length of Command is 80 bytes including Terminate Character.

Timeout: msec Unit

CLK: Trig Signal by Rising Edge

Q: If the execution is completed, Q changes from FALSE to TRUE

Error_Code: 0: No Error

1: Buffer Allocation Error for Sent Command

2: Illegal Parameter Setting for Slot or Channel number

Recv_Ready: 0: Not Ready; 1: Ready

Chapter 6 ADAM-5000 Function Blocks

ADAM4000 Source Codes by Structured Text

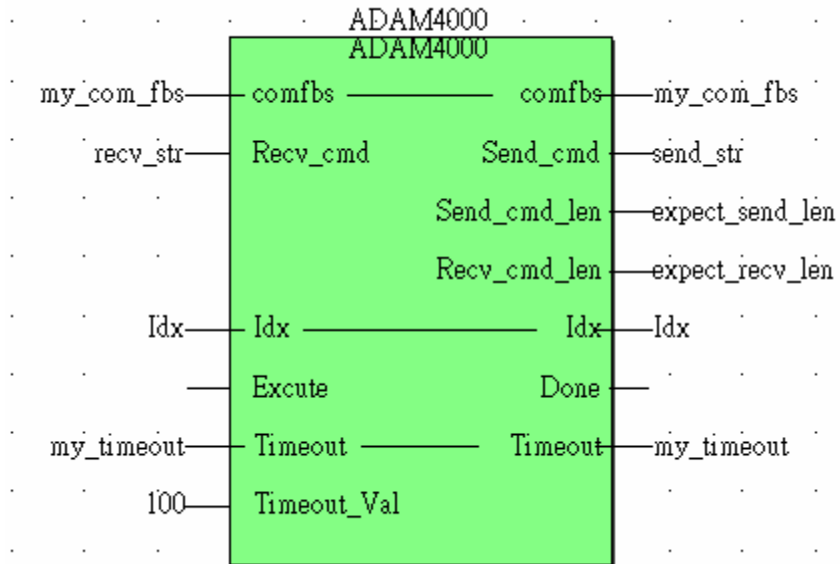

```
(* Set timeout period based on Timeout_Val*Cycle Time *)
Timeout := Timeout+1;
if Timeout > Timeout_Val then (* Poll next module while time-out *)
    Timeout := 0;
    IsCOMMRetry := true; (* Retry is true *)
    if idx < Module_Amt then
        idx := idx+1;
    end_if;
    Excute := true;
else
    IsCOMMRetry := false; (* Retry is false *)
end_if;

if Excute = true then

    Timeout := 0;
    if idx = 0 then (* idx is the index of array *)
        comfbs[1].Send_CMD := '#01'; (* ADAM-4011 ID=1 Read AI Command *)
        comfbs[1].Send_CMD_Len := 3; (* ADAM-4011 AI Command Length Response
                                     excluding Terminate Character *)
        comfbs[1].recv_CMD_Len := 8; (* ADAM-4011 AI Response excluding
                                     Terminate Character *)
```

Chapter 6 ADAM-5000 Function Blocks

```
comfbs[2].Send_CMD := '$026'; (* ADAM-4056S ID=2 Read DO Status
                                Command *)
comfbs[2].Send_CMD_Len := 4; (* ADAM-4056S DO Status Command Length
                                excluding Terminate Character *)
comfbs[2].recv_CMD_Len := 7; (* ADAM-4056S DO Status Response excluding
                                Terminate Character *)

idx := 1;
end_if;

Module_Amt := 2; (* Number of ADAM-4000 Modules *)
if idx > Module_Amt then (* Reset the index to 1 after the last ADAM-4000
                                modulee is polled *)

    idx := 1;
end_if;

Send_cmd := comfbs[idx].Send_CMD; (* Send current command out *)
Send_cmd_len := comfbs[idx].Send_CMD_Len; (* Set sent command length *)
Recv_cmd_len := comfbs[idx].recv_CMD_Len; (* Set received response length *)

if idx = 1 then (* Received response is previous one *)
    prv_Idx := Module_Amt; (* If index is 1 then received response is from the last
                                module *)
else
    prv_Idx := idx-1;
end_if;

if IsCOMMRetry = false then (* Move the string while Retry is false *)
    comfbs[prv_Idx].Recv_cmd := Recv_cmd; (* Received response is previous one *)
end_if;

idx := idx+1;
Done := true;

else

if idx = 0 then (* The ID=1 module must work at program start in this example *)
    Send_cmd := '#01'; (* ADAM-4011 ID=1 Read AI Command *)
    Send_cmd_len := 3; (* ADAM-4011 AI Command Length Response excluding
                                Terminate Character *)
    Recv_cmd_len := 8; (* ADAM-4011 AI Response excluding Terminate
                                Character *)
end_if;
Done := false;

end_if;
```

Chapter 6 ADAM-5000 Function Blocks

Data Type Definition: Com_FBs

```
TYPE
    Com_FBs :
    STRUCT
        Send_CMD : String;
        Recv_CMD : String;
        Send_CMD_Len : int;
        recv_CMD_Len : int;
    END_STRUCT;
END_TYPE
```

Data Type Definition: ASCFB_Array

```
TYPE
    ASCFB_Array : ARRAY [1..10] OF Com_FBs;
END_TYPE
```

Get_ASC_CMD Source Codes by Structured Text

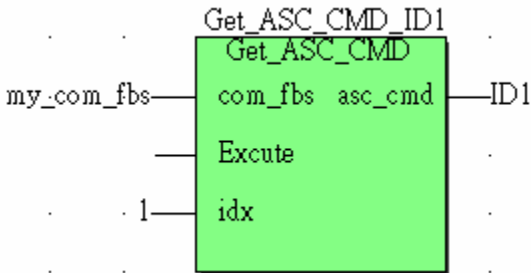

```
if Excute = true then
    asc_cmd := com_fbs[idx].Recv_cmd; (* Get the dedicated response from respective
                                        command of idx *)
end_if;
```

Setting the polling speed

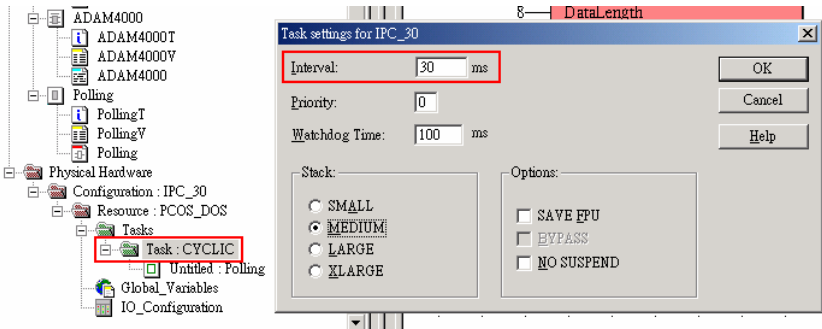

Note: Recommended maximum speed is 30ms.

Supported Firmware Version

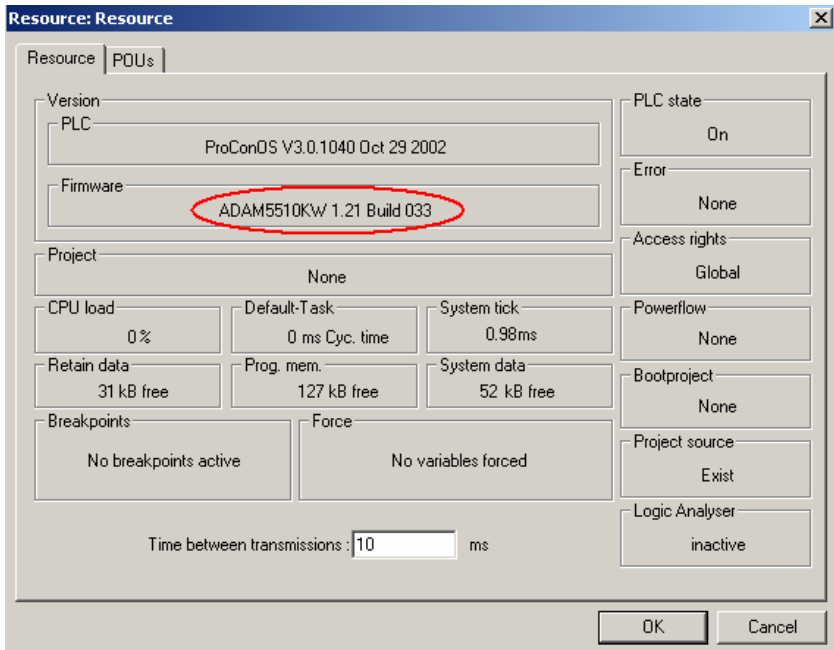

7

Miscellaneous Functions

Chapter 7 Miscellaneous Functions

7.1 Firmware Upgrade

Note 1: Please note that wrong procedures of firmware upgrade will possibly cause potential problem in your system.

Note 2: This function is supported by firmware version 1.21 or later. If the version is older than 1.21, please contact technical support team for further support about how to upgrade the firmware.

Note 3: The project source stored on the controller will be overwritten during the operation of firmware upgrade.

1. Open a new project and click “Project Control Dialog” button.

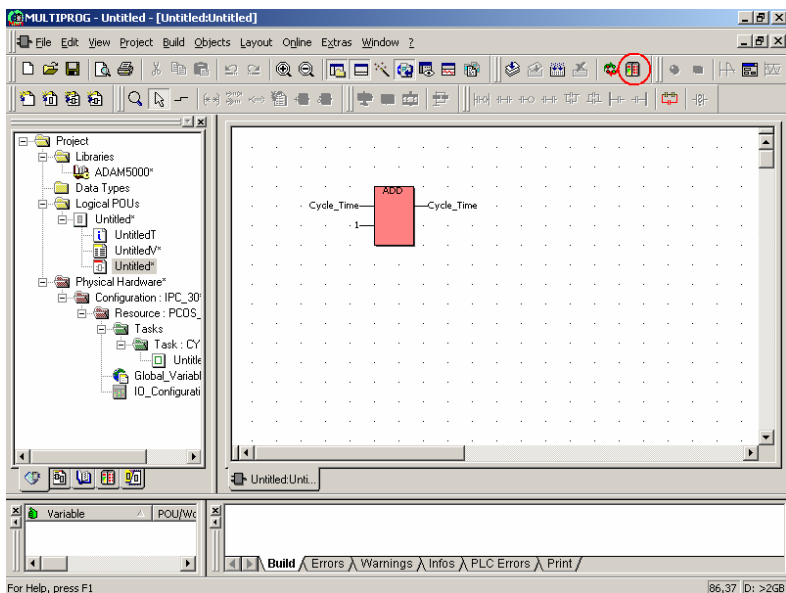

Chapter 7 Miscellaneous Functions

2. Click “Info” button to check the firmware version.

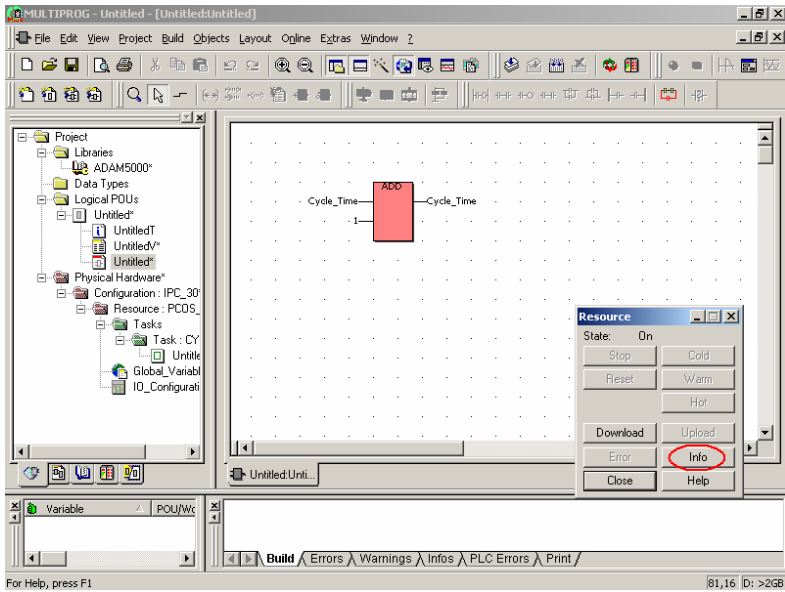

3. Check current firmware version is 1.21.

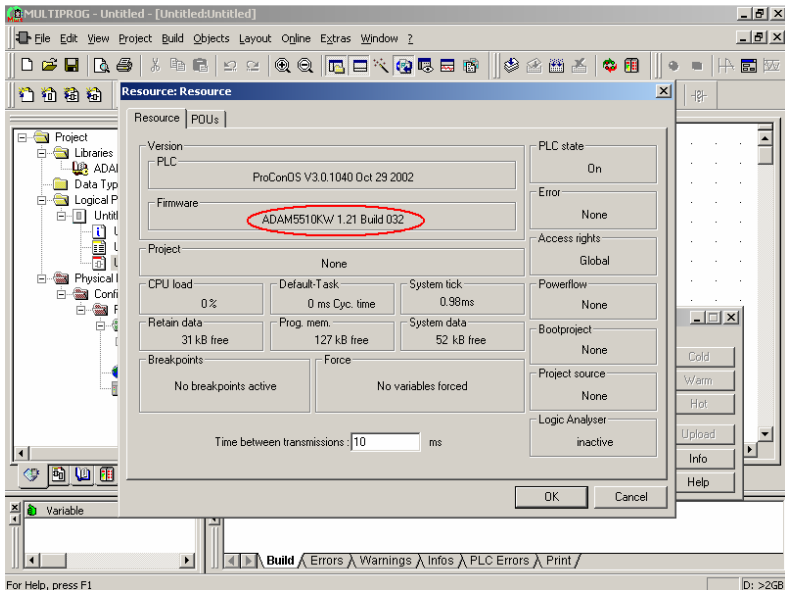

Chapter 7 Miscellaneous Functions

4. Click “Download” button.

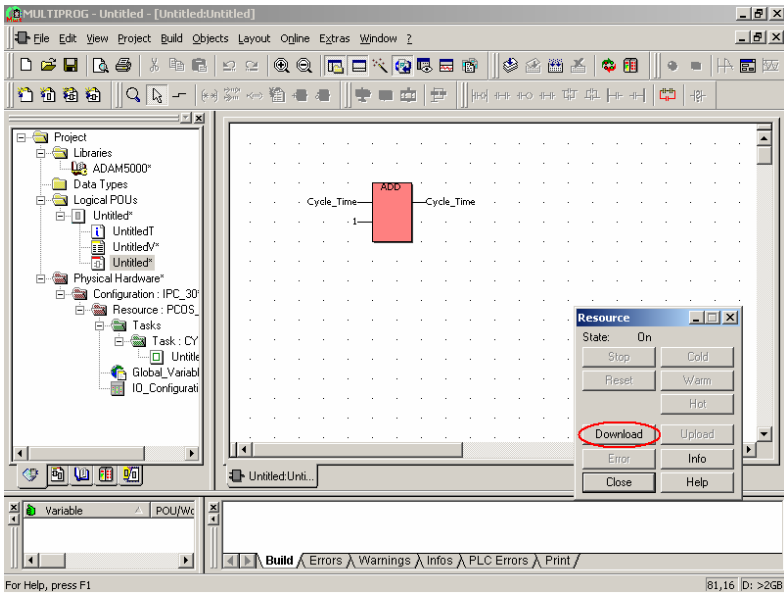

5. Click “Download File” button.

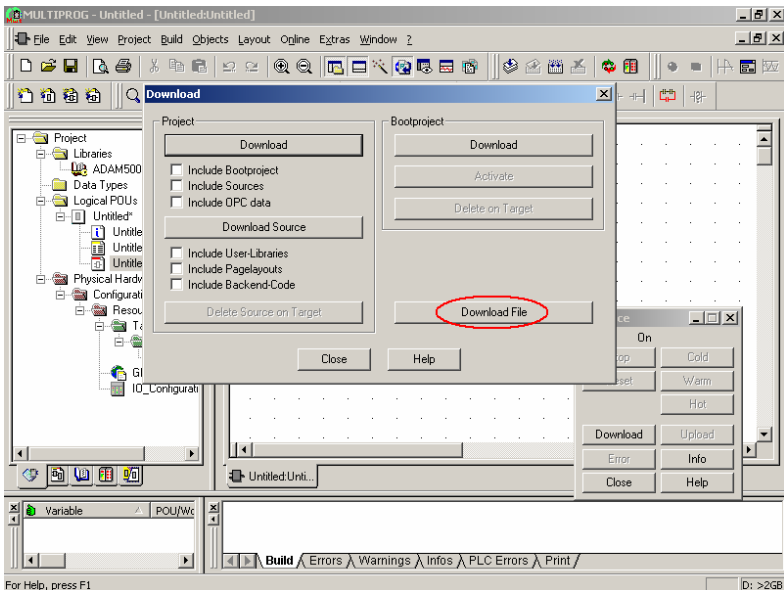

6. Select the new firmware file and click “Download” button.

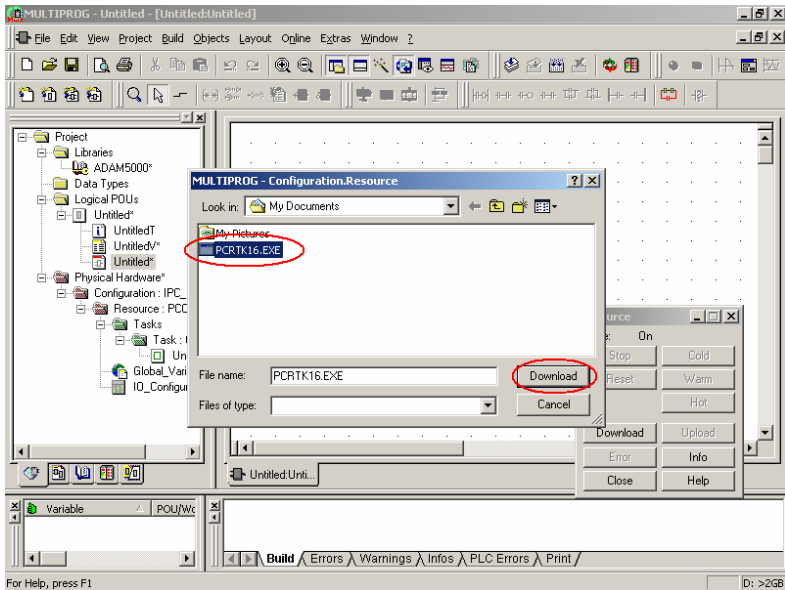

7. The new firmware is downloading.

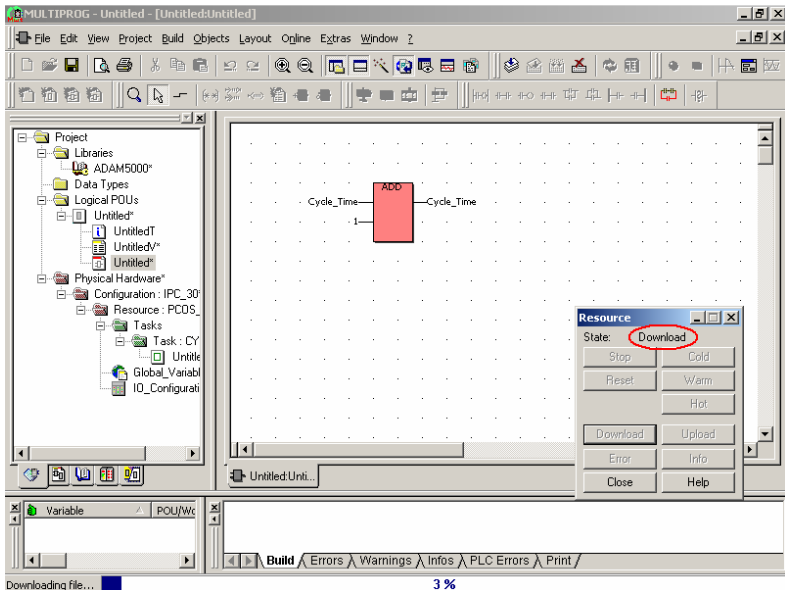

Chapter 7 Miscellaneous Functions

8. After download finished, change the DIP Switch ID to 0 and then press Reset button on ADAM-5510KW Series Controller.

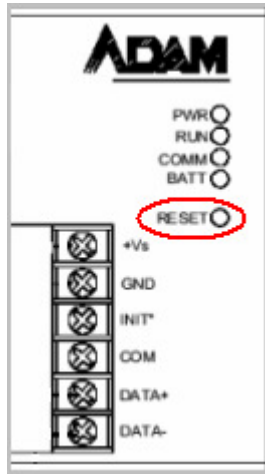

9. The state will be changed to Timeout and PWR/RUN LEDs will be blinking alternately. Please change the DIP Switch ID to original one during the LEDs are blinking.

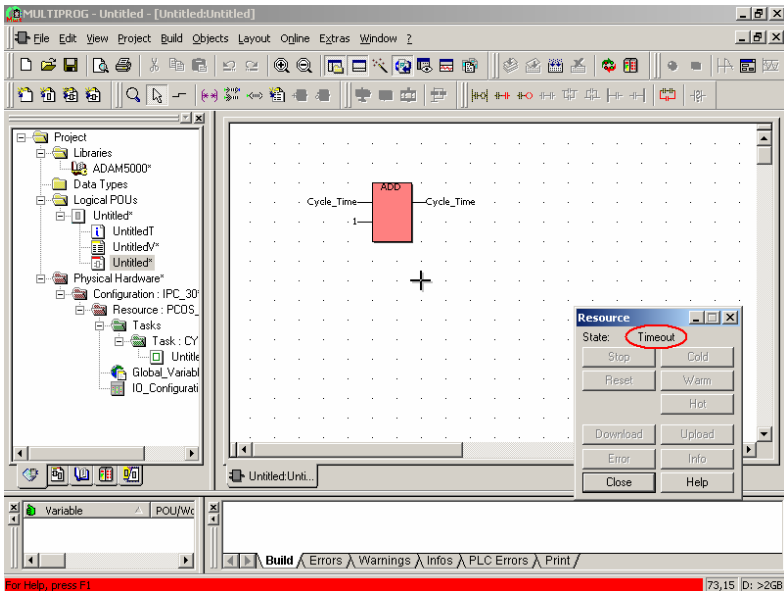

Chapter 7 Miscellaneous Functions

10. When PWR/RUN LEDs stop blinking alternately and PWR/RUN COMM LEDs are turned on, press Reset button on ADAM-5510KW Series Controller and the state will be changed to “On”.

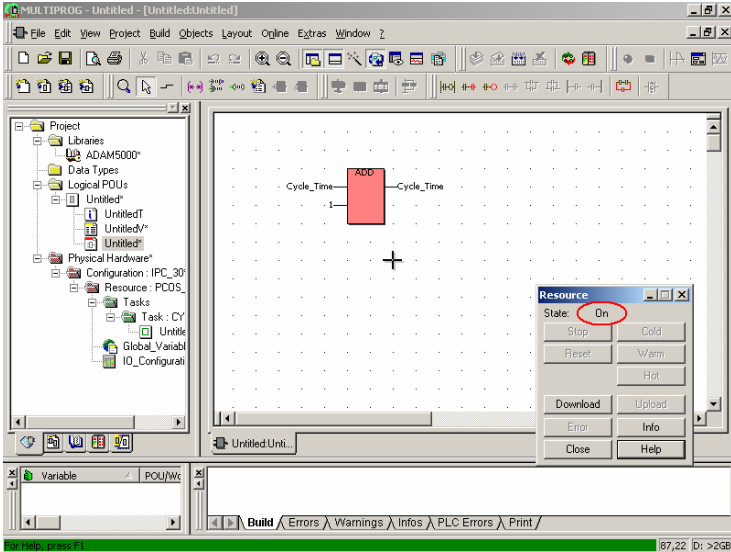

11. Click “Info” button and check the firmware version is upgraded correctly.

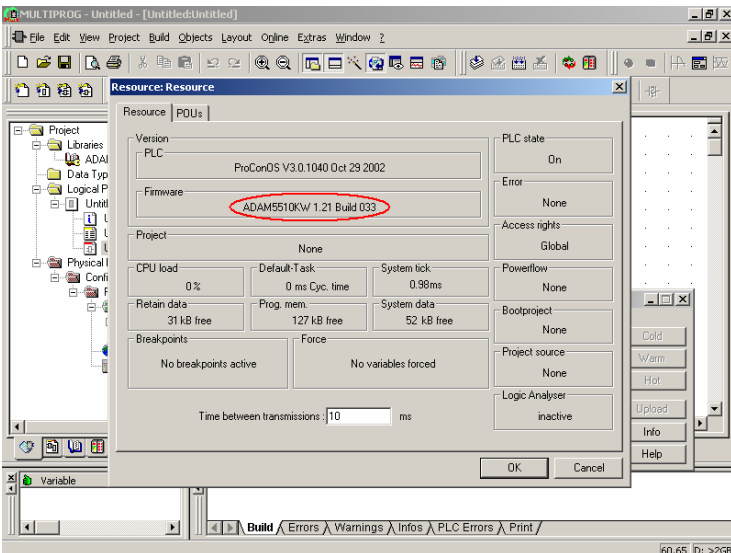

Chapter 7 Miscellaneous Functions

7.2 Save Project Source on ADAM-5510KW Series Controller

1. Check the logical POUs name and click “Download” button.

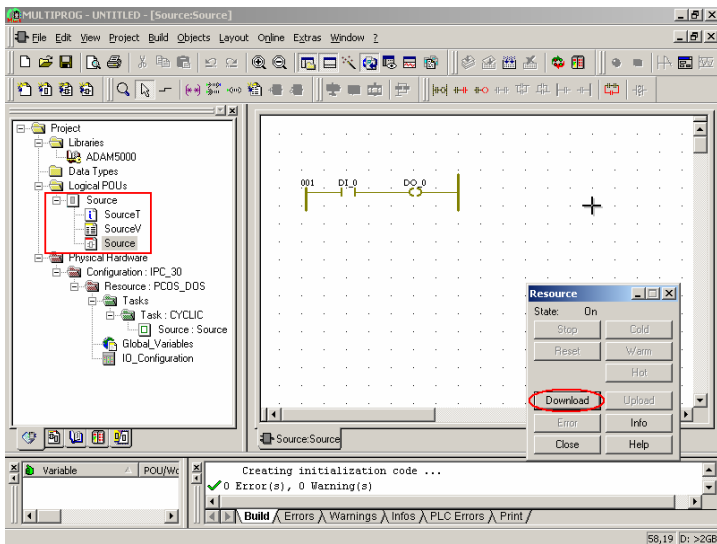

2. Select the items under “Download Source” button and then click “Download Source” button.

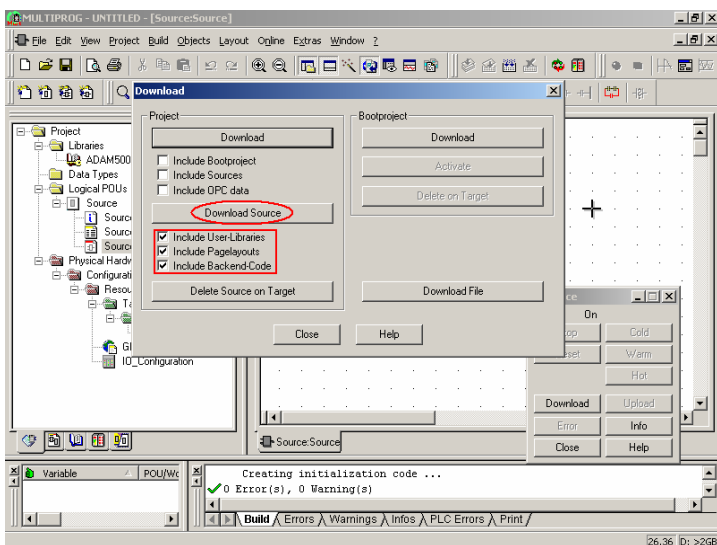

3. Project source code is downloading.

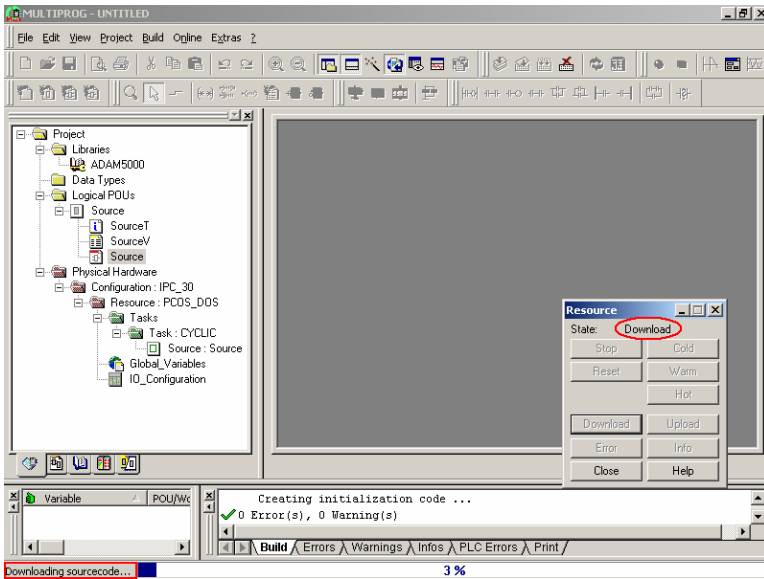

4. The “Upload” button will be activated when project source code has been downloaded correctly.

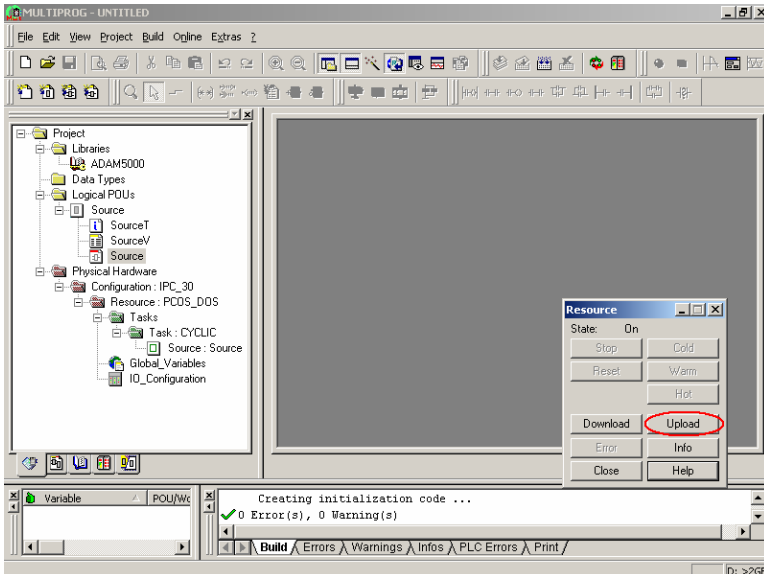

Chapter 7 Miscellaneous Functions

7.3 Upload Project Source from ADAM-5510KW Series Controller

1. Open a new project and click “Upload” button.

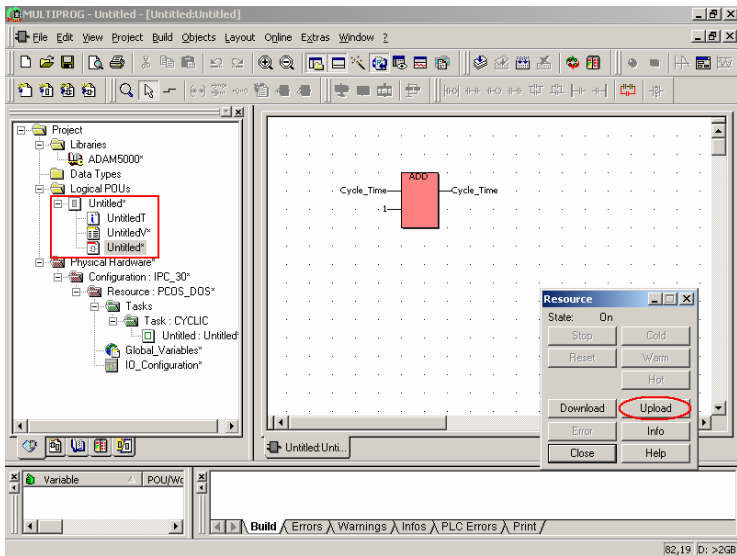

2. Click “Project Source” button.

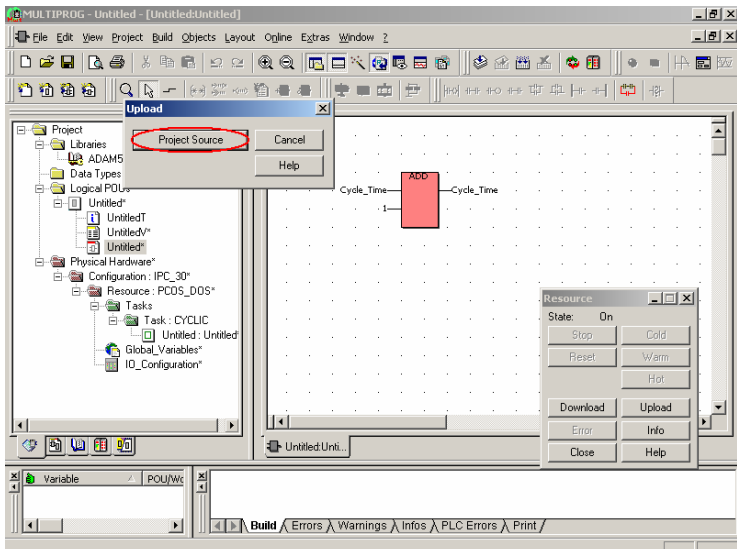

3. The project source code is uploading.

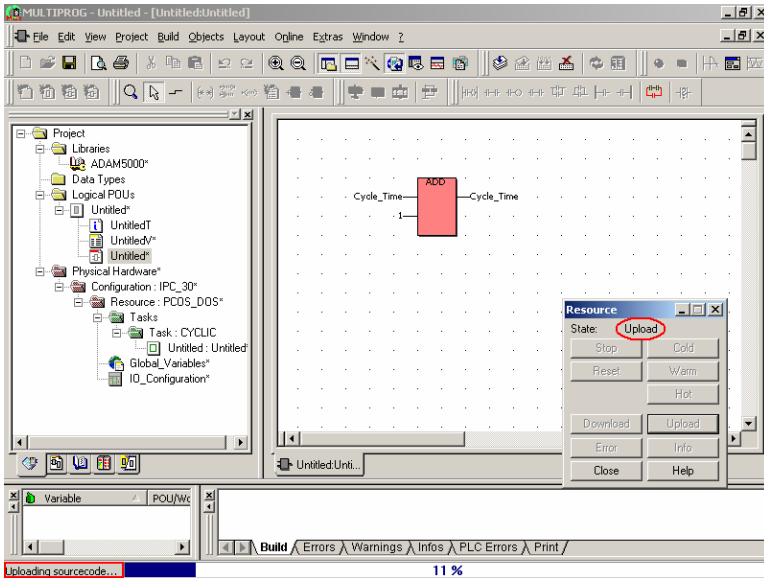

4. When the upload process is finished, following dialog box will appear. Please click "OK" button.

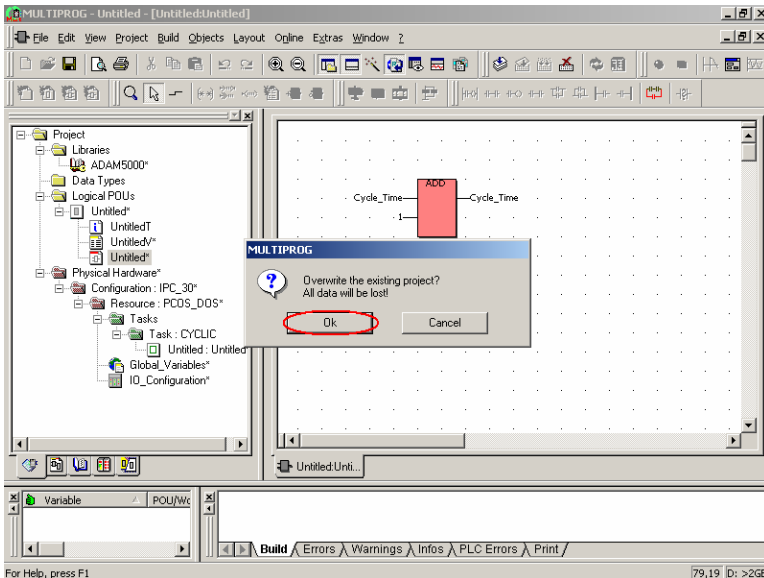

Chapter 7 Miscellaneous Functions

5. Click “Skip all” button to continue.

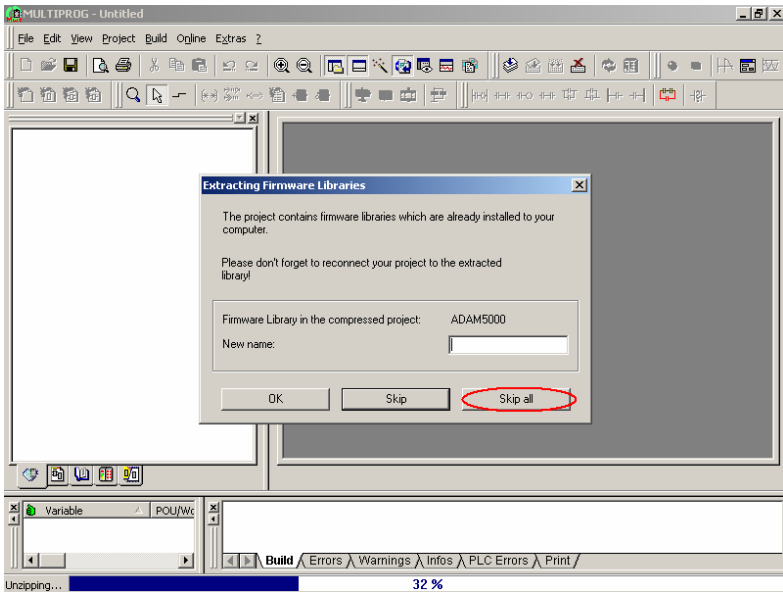

6. Click “Yes to all” button to continue.

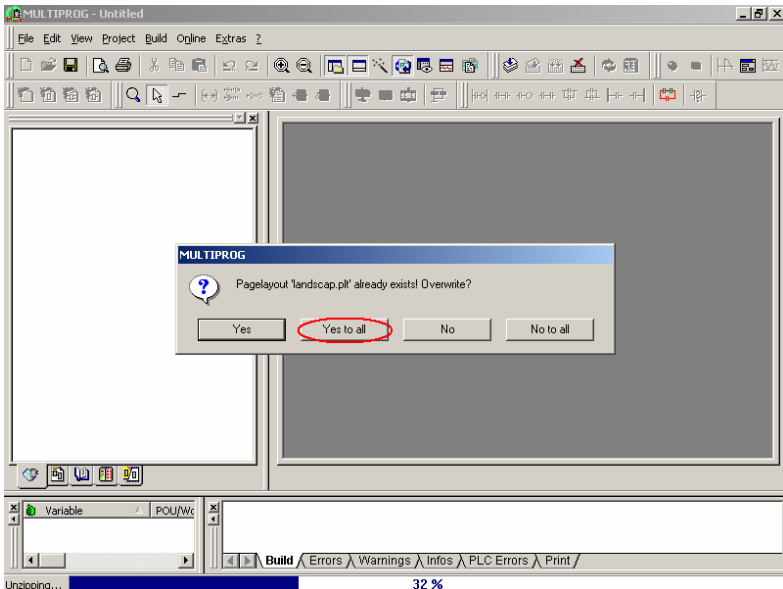

7. Check the POUs name is correct and confirm the project source code has been uploaded correctly.

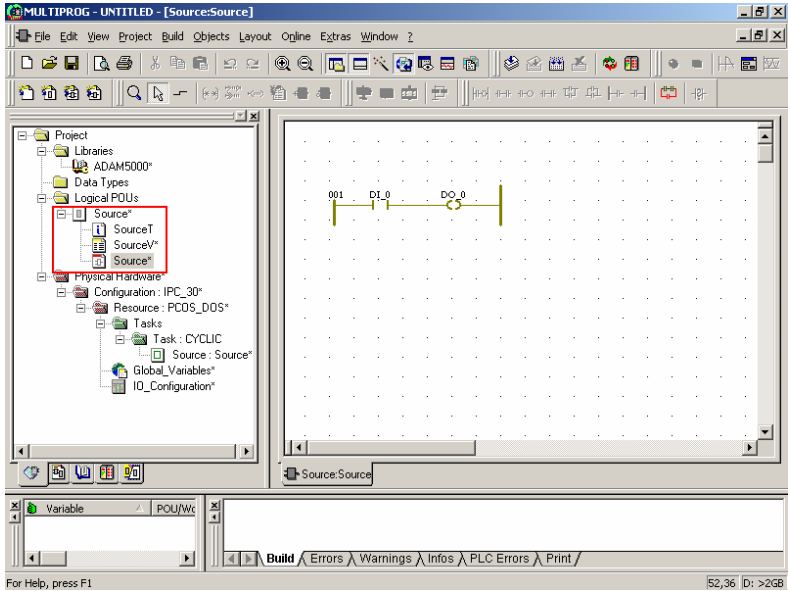

Chapter 7 Miscellaneous Functions

7.4 Example of changing Language Interface from English to Traditional Chinese

1. Click “Extras\Options” item.

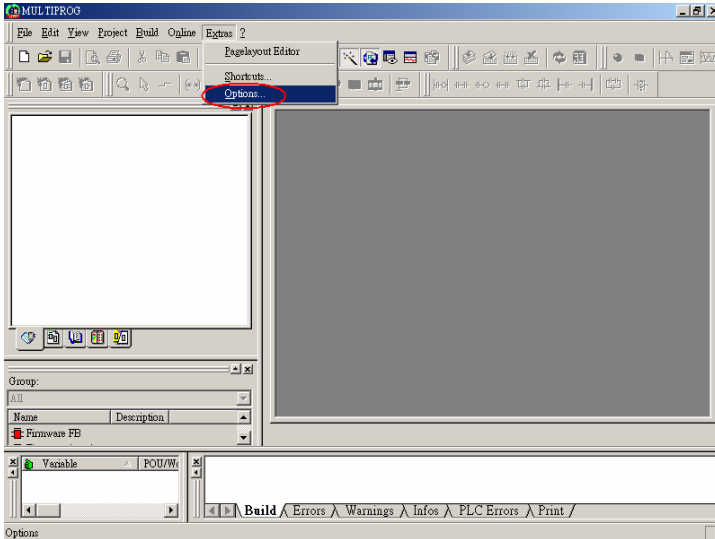

2. Select “Trad. Chinese” item.

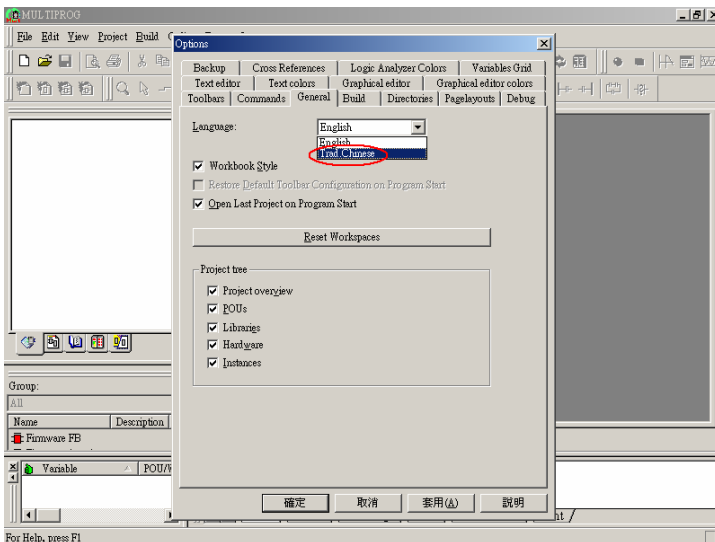

3. Click “Apply” and “OK” buttons.

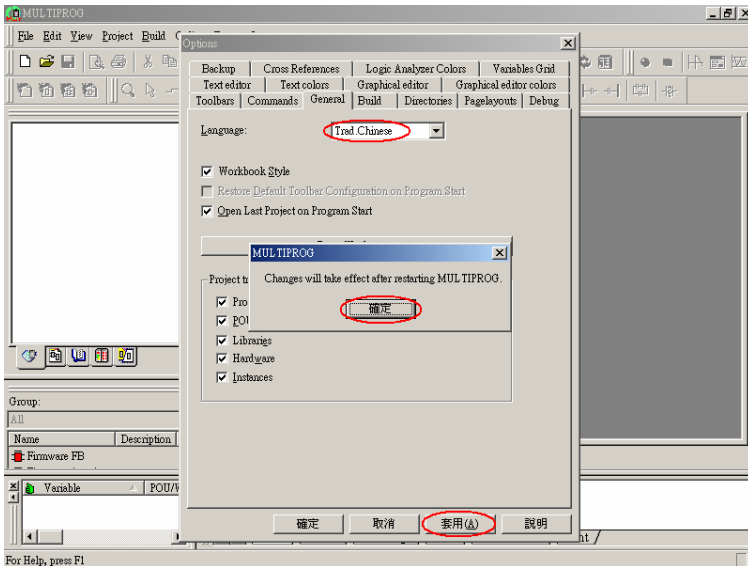

4. Close Multiprog and then reload it. The Language Interface will change to Traditional Chinese as following.

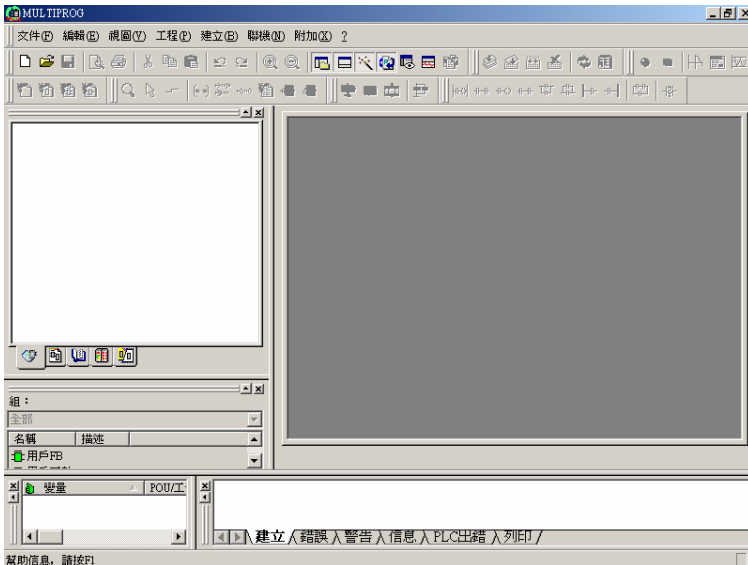

Appendix A

COM Port Register Structure

Appendix A COM Port Register Structure

This appendix gives a short description of each module's registers. For more information, please refer to the STARTECH 16C550 UART chip data book. All registers are one byte. Bit 0 is the least significant bit, and bit 7 is the most significant bit. The address of each register is specified as an offset from the port base address (BASE), COM1 is 3F8h and COM2 is 2F8h.

- DLAB is the "Divisor Latch Access Bit", bit 7 of BASE+3.
- BASE+0 Receiver buffer register when DLAB=0 and the operation is a read.
- BASE+0 Transmitter holding register when DLAB=0 and the operation is write.
- BASE+0 Divisor latch bits 0 - 7 when DLAB=1
- BASE+1 Divisor latch bits 8-15 when DLAB=1.

Bytes BASE+0 and BASE+1 together form a 16-bit number, the divisor, which determines the baud rate. Set the divisor as follows:

Baud rate	Divisor	Baud rate	Divisor
50	2304	2400	48
75	1536	3600	32
110	1047	4800	24
133.5	857	7200	16
150	768	9600	12
300	384	19200	6
600	192	38400	3
1200	96	56000	2
1800	64	115200	1
2000	58	x	x

Appendix A COM Port Register Structure

BASE+1 Interrupt Status Register (ISR) when DLAB=0
bit 0: Enable received-data-available interrupt
bit 1: Enable transmitter-holding-register-empty interrupt
bit 2: Enable receiver-line-status interrupt
bit 3: Enable modem-status interrupt

BASE+2 FIFO Control Register (FCR)
bit 0: Enable transmit and receive FIFOs
bit 1: Clear contents of receive FIFO
bit 2: Clear contents of transmit FIFO
bits 6-7: Set trigger level for receiver FIFO interrupt

Bit 7	Bit 6	FIFO trigger level
0	0	01
0	1	04
1	0	08
1	1	14

BASE+3 Line Control Register (LCR)
bit 0: Word length select bit 0
bit 1: Word length select bit 1

Bit 1	Bit 0	Word length (bits)
0	0	5
0	1	6
1	0	7
1	1	8

Appendix A COM Port Register Structure

BASE+4	Modem Control Register (MCR) bit 0: DTR bit 1: RTS
BASE+5	Line Status Register (LSR) bit 0: Receiver data ready bit 1: Overrun error bit 2: Parity error bit 3: Framing error bit 4: Break interrupt bit 5: Transmitter holding register empty bit 6: Transmitter shift register empty bit 7: At least one parity error, framing error or break indication in the FIFO
BASE+6	Modem Status Register (MSR) bit 0: Delta CTS bit 1: Delta DSR bit 2: Trailing edge ring indicator bit 3: Delta received line signal detect bit 4: CTS bit 5: DSR bit 6: RI bit 7: Received line signal detect
BASE+7	Temporary data register

Appendix B

Data Formats and I/O Ranges

B.1 Analog Input Formats

The ADAM analog input modules can be configured to transmit data to the host in Engineering Units.

Engineering Units

Data can be represented in Engineering Units by setting bits 0 and 1 of the data format/checksum/integration time parameter to 0. This format presents data in natural units, such as degrees, volts, millivolts, and milliamps. The Engineering Units format is readily parsed by the majority of computer languages because the total data string length, including sign, digits and decimal point, does not exceed seven characters.

The data format is a plus (+) or minus (-) sign, followed by five decimal digits and a decimal point. The input range which is employed determines the resolution, or the number of decimal places used, as illustrated in the following table:

Input Range	Resolution
± 15 mV, ± 50 mV	1 μ V (three decimal places)
± 100 mV, ± 150 mV, ± 500 mV	10 μ V (two decimal places)
± 1 V, ± 2.5 V, ± 5 V	100 μ V (four decimal places)
± 10 V	1 mV (three decimal places)
± 20 mA	1 μ A (three decimal places)
Type J and T thermocouple	0.01°C (two decimal places)
Type K, E, R, S, and B thermocouple	0.1°C (one decimal place)

Example 1

The input value is -2.65 V and the corresponding analog input module is configured for a range of ± 5 V. The response to the Analog Data In command is:

-2.6500(cr)

Example 2

The input value is 305.5°C. The analog input module is configured for a Type J thermocouple whose range is 0°C to 760°C. The response to the Analog Data In command is:

+305.50(cr)

Example 3

The input value is +5.653 V. The analog input module is configured for a range of ± 5 V range. When the engineering units format is used, the ADAM Series analog input modules are configured so that they automatically provide an over range capability. The response to the Analog Data In command in this case is:

+5.6530(cr)

Appendix B Data Formats and I/O Ranges

B.2 Analog Input Ranges - ADAM-5017

Module	Range Code	Input Range Description	Data Formats	+F.S.	Zero	-F.S.	Displayed Resolution	Actual Value
ADAM-5017	08h	±10 V	Engineering Units	+10.000	±000.000	-10.000	1 mV	Reading/ 1000
			% of FSR	+100.00	±000.00	-100.00	0.01%	
			Two's Complement	7FFF	0000	8000	1 LSB	
	09h	±5 V	Engineering Units	+5.0000	±0.0000	-5.0000	100.00 µV	Reading/ 1000
			% of FSR	+100.00	±000.00	-100.00	0.01%	
			Two's Complement	7FFF	0000	8000	1 LSB	
	0Ah	±1 V	Engineering Units	+1.0000	±0.0000	-1.0000	100.00 µV	Reading/ 10000
			% of FSR	+100.00	±000.00	-100.00	0.01%	
			Two's Complement	7FFF	0000	8000	1 LSB	
	0Bh	±500 mV	Engineering Units	+500.00	±000.00	-500.00	10 µV	Reading/ 10
			% of FSR	+100.00	±000.00	-100.00	0.01%	
			Two's Complement	7FFF	0000	8000	1 LSB	
	0Ch	±150 mV	Engineering Units	+150.00	±000.00	-150.00	10 µV	Reading/ 100
			% of FSR	+100.00	±000.00	-100.00	0.01%	
			Two's Complement	7FFF	0000	8000	1 LSB	
	0Dh	±20 mA	Engineering Units	+20.000	±00.000	-20.000	1 µV	Reading/ 1000
			% of FSR	+100.00	±000.00	-100.00	0.01%	
			Two's Complement	7FFF	0000	8000	1 LSB	

B.3 Analog Input Ranges - ADAM-5018

Module	Range Code	Input Range Description	Data Formats	+F.S.	Zero	-F.S.	Displayed Resolution	Actual Value
ADAM-5018	00h	±15 mV	Engineering Units	+15.000	±00.000	-15.000	1 µV	Reading/ 1000
			% of FSR	+100.00	±000.00	-100.00	0.01%	
			Two's Complement	7FFF	0000	8000	1 LSB	
	01h	±50 mV	Engineering Units	+50.000	±00.000	-50.000	1 µV	Reading/ 100
			% of FSR	+100.00	±000.00	-100.00	0.01%	
			Two's Complement	7FFF	0000	8000	1 LSB	
	02h	±100 mV	Engineering Units	+100.00	±000.00	-100.00	10 µV	Reading/ 100
			% of FSR	+100.00	±000.00	-100.00	0.01%	
			Two's Complement	7FFF	0000	8000	1 LSB	
	03h	±500 mV	Engineering Units	+500.00	±000.00	-500.00	10 µV	Reading/ 10
			% of FSR	+100.00	±000.00	-100.00	0.01%	
			Two's Complement	7FFF	0000	8000	1 LSB	
	04h	±1 V	Engineering Units	+1.0000	±0.0000	-1.0000	100 µV	Reading/ 10000
			% of FSR	+100.00	±000.00	-100.00	0.01%	
			Two's Complement	7FFF	0000	8000	1 LSB	
	05h	±2.5 V	Engineering Units	+2.5000	±0.0000	-2.5000	100 µV	Reading/ 10000
			% of FSR	+100.00	±000.00	-100.00	0.01%	
			Two's Complement	7FFF	0000	8000	1 LSB	
	06h	±20 mA	Engineering Units	+20.000	±00.000	-20.000	1 µA	Reading/ 1000
			% of FSR	+100.00	±000.00	-100.00	0.01%	
			Two's Complement	7FFF	0000	8000	1 LSB	
07h	Not Used							

Appendix B Data Formats and I/O Ranges

Module	Range Code	Input Range Description	Data Formats	Maximum Specified Signal	Minimum Specified Signal	Displayed Resolution	Actual Value
ADAM-5018	0Eh	Type J Thermocouple 0°C to 760°C	Engineering Units	+760.00	+000.00	0.1°C	Reading/ 10
			% of FSR	+100.00	+000.00	0.01%	
			Two's Complement	7FFF	0000	1 LSB	
	0Fh	Type K Thermocouple 0°C to 1370°C	Engineering Units	+1370.0	+0000.0	0.1°C	Reading/ 10
			% of FSR	+100.00	+000.00	0.01%	
			Two's Complement	7FFF	0000	1 LSB	
	10h	Type T Thermocouple -100°C to 400°C	Engineering Units	+400.00	-100.00	0.1°C	Reading/ 10
			% of FSR	+100.00	-025.00	0.01%	
			Two's Complement	7FFF	E000	1 LSB	
	11h	Type E Thermocouple 0°C to 1000°C	Engineering Units	+1000.00	+0000.0	0.1°C	Reading/ 10
			% of FSR	+100.00	±000.00	0.01%	
			Two's Complement	7FFF	0000	1 LSB	
	12h	Type R Thermocouple 500°C to 1750°C	Engineering Units	+1750.0	+0500.0	0.1°C	Reading/ 10
			% of FSR	+100.00	+028.57	0.01%	
			Two's Complement	7FFF	2492	1 LSB	
	13h	Type S Thermocouple 500°C to 1750°C	Engineering Units	+1750.0	+0500.00	0.1°C	Reading/ 10
			% of FSR	+100.00	+028.57	0.01%	
			Two's Complement	7FFF	2492	1 LSB	
14h	Type B Thermocouple 500°C to 1800°C	Engineering Units	+1800.0	+0500.0	0.1°C	Reading/ 10	
		% of FSR	+100.00	+027.77	0.01%		
		Two's Complement	7FFF	2381	1 LSB		

B.4 Analog Input Ranges - ADAM-5017H

Range Code	Input Range	Data Formats	+Full Scale	Zero	Scale	-Full	Displayed Resolution
00h	±10 V	Engineering	11	0	-11		2.7 mV
		Two's Comp	0FFF	0	EFFF		1
01h	0 ~ 10 V	Engineering	11	0	Don't care		2.7 mV
		Two's Comp	0FFF	0	Don't care		1
02h	±5 V	Engineering	5.5	0	-5.5		1.3 mV
		Two's Comp	0FFF	0	EFFF		1
03h	0 ~ 5 V	Engineering	5.5	0	Don't care		1.3 mV
		Two's Comp	0FFF	0	Don't care		1
04h	±2.5 V	Engineering	2.75	0	-2.75		0.67 mV
		Two's Comp	0FFF	0	EFFF		1
05h	0 ~ 2.5 V	Engineering	2.75	0	Don't care		0.67 mV
		Two's Comp	0FFF	0	Don't care		1
06h	±1 V	Engineering	1.375	0	-1.375		0.34 mV
		Two's Comp	0FFF	0	EFFF		1
07h	0 ~ 1 V	Engineering	1.375	0	Don't care		0.34 mV
		Two's Comp	0FFF	0	Don't care		1
08h	±500 mV	Engineering	687.5	0	-687.5		0.16 mV
		Two's Comp	0FFF	0	EFFF		1
09h	0 ~ 500 mV	Engineering	687.5	0	Don't care		0.16 mV
		Two's Comp	0FFF	0	Don't care		1
0ah	4 ~ 20 mA	Engineering	22	4.0	Don't care		5.3 µA
		Two's Comp	0FFF	02E9	Don't care		1
0bh	0 ~ 20 mA	Engineering	22	0	Don't care		5.3 µA
		Two's Comp	0FFF	0	Don't care		1

Note: The full scale values in this table are theoretical values for your reference; actual values will vary.

B.5 Analog Output Formats

You can configure ADAM analog output modules to receive data from the host in Engineering Units.

Engineering Units

Data can be represented in engineering units by setting bits 0 and 1 of the data format/checksum/integration time parameter to 0. This format presents data in natural units, such as milliamps. The Engineering Units format is readily parsed by the majority of computer languages as the total data string length is fixed at six characters: two decimal digits, a decimal point and three decimal digits. The resolution is 5 μ A.

Example:

An analog output module on channel 1 of slot 0 in an ADAM-5000 system at address 01h is configured for a 0 to 20 mA range. If the output value is +4.762 mA, the format of the Analog Data Out command would be #01S0C14.762<cr>

B.6 Analog Output Ranges

Range Code	Output Range Description	Data Formats	Maximum Specified Signal	Minimum Specified Signal	Displayed Resolution
30	0 to 20 mA	Engineering Units	20.000	00.000	5 μ A
		% of Span	+100.00	+000.00	5 μ A
		Hexadecimal Binary	FFF	000	5 μ A
31	4 to 20 mA	Engineering Units	20.000	04.000	5 μ A
		% of Span	+100.00	+000.00	5 μ A
		Hexadecimal Binary	FFF	000	5 μ A
32	0 to 10 V	Engineering Units	10.000	00.000	2.442 mV
		% of Span	+100.00	+000.00	2.442 mV
		Hexadecimal Binary	FFF	000	2.442 mV

B.7 ADAM-5013 RTD Input Format and Ranges

Range Code (hex)	Input Range Description	Data Formats	Maximum Specified Signal	Minimum Specified Signal	Displayed Resolution
20	100 Ohms Platinum RTD -100 to 100 °C a=0.00385	Engineering Units	+100.00	-100.00	±0.1 °C
21	100 Ohms Platinum RTD 0 to 100 °C a=0.00385	Engineering Units	+100.00	+000.00	±0.1 °C
22	100 Ohms Platinum RTD 0 to 200 °C a=0.00385	Engineering Units	+200.00	+000.00	±0.2 °C
23	100 Ohms Platinum RTD 0 to 600 °C a=0.00385	Engineering Units	+600.00	+000.00	±0.6 °C
24	100 Ohms Platinum RTD -100 to 100 °C a=0.00392	Engineering Units	+100.00	-100.00	±0.1 °C
25	100 Ohms Platinum RTD 0 to 100 °C a=0.00392	Engineering Units	+100.00	+000.00	±0.1 °C
26	100 Ohms Platinum RTD 0 to 200 °C a=0.00392	Engineering Units	+200.00	+000.00	±0.2 °C

Note: See next page for table continuation.

Appendix B Data Formats and I/O Ranges

Note: This table continued from previous page.

27	100 Ohms Platinum RTD 0 to 600 °C a=0.00392	Engineering Units	+600.00	+000.00	±0.6 °C
28	120 Ohms Nickel RTD -80 to 100 °C	Engineering Units	+100.00	-80.00	±0.1 °C
29	120 Ohms Nickel RTD 0 to 100 °C	Engineering Units	+100.00	+000.00	±0.1 °C

Appendix B Data Formats and I/O Ranges

ADAM 5000 AI/AO Scaling

Module	Type	Range Low	Range High	Scale Low	Scale High	Data Format	
5013RTD	385(IEC)	-100	100	0	65535	U16B	
		0	100	0	65535	U16B	
		0	200	0	65535	U16B	
		0	600	0	65535	U16B	
	395(JIS)	-100	100	0	65535	U16B	
		0	100	0	65535	U16B	
		0	200	0	65535	U16B	
		0	600	0	65535	U16B	
	Ni	-80	100	0	65535	U16B	
		0	100	0	65535	U16B	
5017AI	mV	-150	150	0	65535	U16B	
	mV	-500	500	0	65535	U16B	
	V	-1	1	0	65535	U16B	
	V	-5	5	0	65535	U16B	
	V	-10	10	0	65535	U16B	
	mA	-20	20	0	65535	U16B	
5017H AI	mV	-500	500	0	4095	U12B	
	mV	0	500	0	4095	U12B	
	V	-10	10	0	4095	U12B	
	V	0	10	0	4095	U12B	
	V	-5	5	0	4095	U12B	
	V	0	5	0	4095	U12B	
	V	-2.5	2.5	0	4095	U12B	
	V	0	2.5	0	4095	U12B	
	V	-1	1	0	4095	U12B	
	V	0	1	0	4095	U12B	
	mA	4	20	0	4095	U12B	
	mA	0	20	0	4095	U12B	
	5018 AI	mV	-15	15	0	65535	U16B
		mV	-50	50	0	65535	U16B
mV		-100	100	0	65535	U16B	
mV		-500	500	0	65535	U16B	
V		-1	1	0	65535	U16B	
V		-2.5	2.5	0	65535	U16B	
mA		-20	20	0	65535	U16B	
T/C(J)		0	760	0	65535	U16B	
T/C(K)		0	1370	0	65535	U16B	
T/C(T)		-100	400	0	65535	U16B	
T/C(E)		0	1000	0	65535	U16B	
T/C(R)		500	1750	0	65535	U16B	
T/C(S)		500	1750	0	65535	U16B	
T/C(B)		500	1800	0	65535	U16B	
5024 AO	V	0	10	0	4095	U12B	
	mA	4	20	0	4095	U12B	
	mA	0	20	0	4095	U12B	

Appendix C

RS-485 Network

Appendix C RS-485 Network

EIA RS-485 is the industry's most widely used bidirectional, balanced transmission line standard. It is specifically developed for industrial multi-drop systems that should be able to transmit and receive data at high rates or over long distances.

The specifications of the EIA RS-485 protocol are as follows:

- ♦ Maximum line length per segment: 1200 meters (4000 feet)
- ♦ Throughput of 10 Mbaud and beyond -Differential transmission (balanced lines) with high resistance against noise
- ♦ Maximum 32 nodes per segment
- ♦ Bi-directional master-slave communication over a single set of twisted-pair cables
- ♦ Parallel connected nodes, true multi-drop

ADAM-5510KW Series Controller is fully isolated and use just a single set of twisted pair wires to send and receive! Since the nodes are connected in parallel they can be freely disconnected from the host without affecting the functioning of the remaining nodes. An industry standard, shielded twisted pair is preferable due to the high noise ratio of the environment. When nodes communicate through the network, no sending conflicts can occur since a simple command/response sequence is used. There is always one initiator (with no address) and many slaves (with addresses). In this case, the master is a personal computer that is connected with its serial, RS-232, port to an ADAM RS-232/RS-485 converter. The slaves are the ADAM-5510KW Series Controller. When systems are not transmitting data, they are in listen mode. The host computer initiates a command/response sequence with one of the systems. Commands normally contain the address of the module the host wants to communicate with. The system with the matching address carries out the command and sends its response to the host.

C.1 Basic Network Layout

Multi-drop RS-485 implies that there are two main wires in a segment. The connected systems tap from these two lines with so called drop cables. Thus all connections are parallel and connecting or disconnecting of a node doesn't affect the network as a whole. Since ADAM-5510KW Series Controller use the RS-485 standard, they can connect and communicate with the host PC. The basic layouts that can be used for an RS-485 network are:

Daisychain

The last module of a segment is a repeater. It is directly connected to the main-wires thereby ending the first segment and starting the next segment. Up to 32 addressable systems can be daisychained . This limitation is a physical one. When using more systems per segment the IC driver current rapidly decreases, causing communication errors. In total, the network can hold up to 64 addressable systems. The limitation on this number is the two-character hexadecimal address code that can address 64 combinations. The ADAM converter, ADAM repeaters and the host computer are non addressable units and therefore are not included in these numbers.

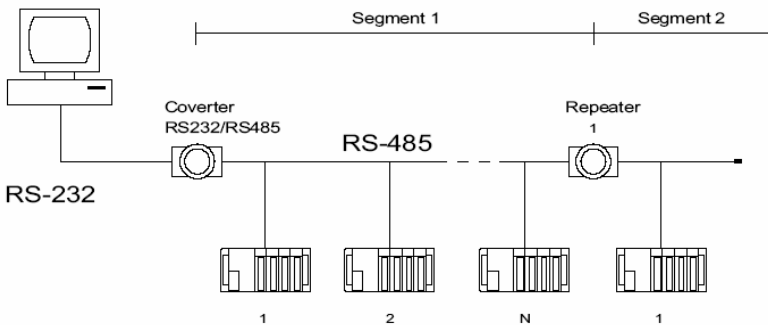

Figure C-1: Daisychaining

Star Layout

In this scheme the repeaters are connected to drop-down cables from the main wires of the first segment. A tree structure is the result. This scheme is not recommended when using long lines since it will cause a serious amount of signal distortion due to signal reflections in several line-endings.

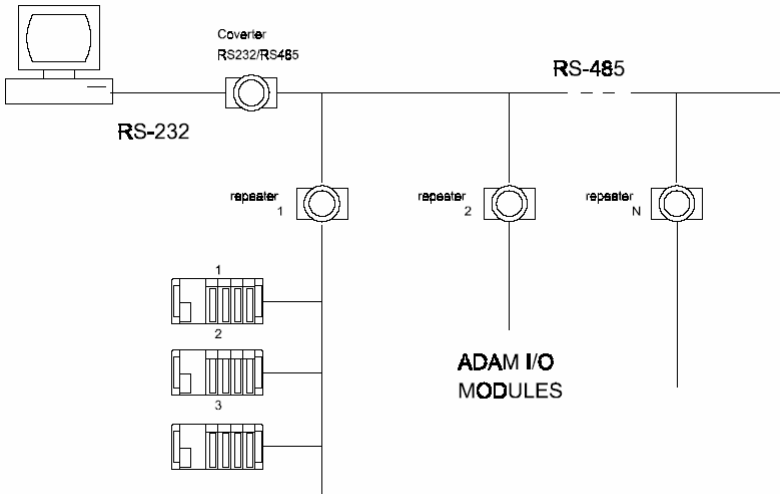

Figure C-2: Star structure

Random

This is a combination of daisychain and hierarchical structure.

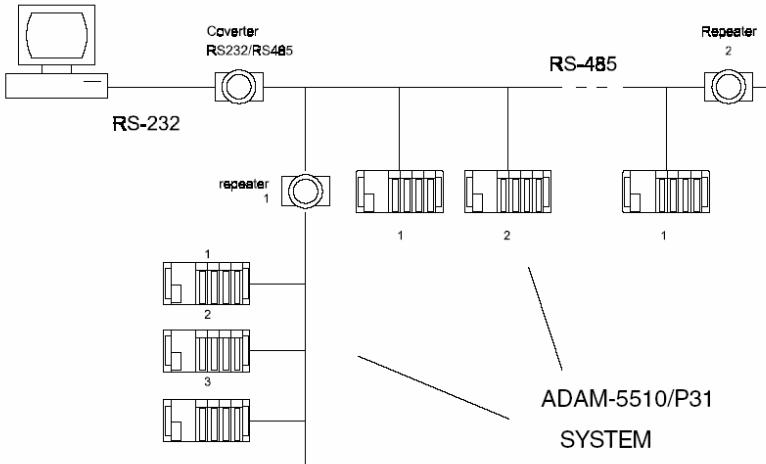

Figure C-3: Random structure

C.2 Line Termination

Each discontinuity in impedance causes reflections and distortion. When a impedance discontinuity occurs in the transmission line the immediate effect is signal reflection. This will lead to signal distortion. Specially at line ends this mismatch causes problems. To eliminate this discontinuity, terminate the line with a resistor.

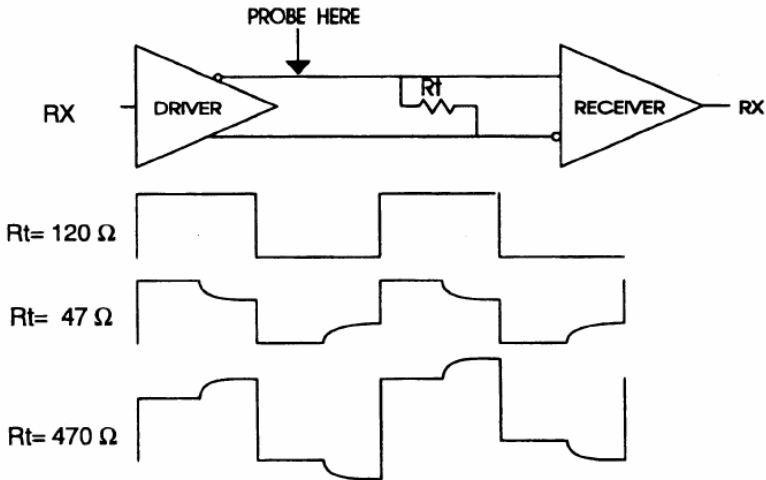

Figure C-4: Signal distortion

The value of the resistor should be as close as possible to the characteristic impedance of the line. Although receiver devices add some resistance to the whole of the transmission line, normally it is sufficient if the resistor impedance should equal the characteristic impedance of the line.

Example: Each input of the receivers has a nominal input impedance of 18 k Ω feeding into a diode transistor-resistor biasing network that is equivalent to an 18 k Ω input resistor tied to a common mode voltage of 2.4 V. It is this configuration, which provides the large common range of the receiver required for RS-485 systems! (See Figure D-5 below).

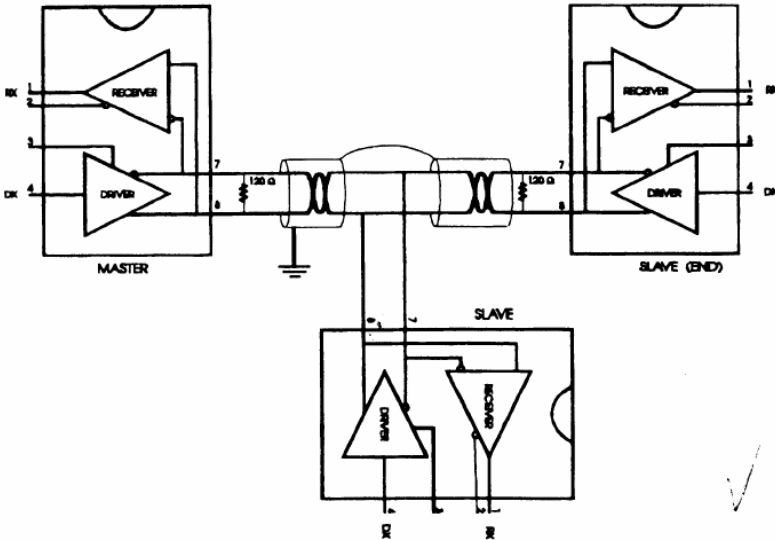

Figure C-5: Termination resistor locations

Because each input is biased to 2.4 V, the nominal common mode voltage of balanced RS-485 systems, the 18 k Ω on the input can be taken as being in series across the input of each individual receiver. If thirty of these receivers are put closely together at the end of the transmission line, they will tend to react as thirty 36k resistors in parallel with the termination resistor. The overall effective resistance will need to be close to the characteristics of the line. The effective parallel receiver resistance R_P will therefore be equal to:

$$R_P = 36 \times 10^3 / 30 = 1200 \Omega$$

While the termination receptor R_T will equal:

$$R_T = R_o / [1 - R_o / R_P]$$

Thus for a line with a characteristic impedance of 100 resistor $R_T = 100 / [1 - 100 / 1200] = 110 \Omega$

Since this value lies within 10% of the line characteristic impedance.

Thus as already stated above the line termination resistor R_T will normally equal the characteristic impedance Z_0 . The star connection causes a multitude of these discontinuities since there are several transmission lines and is therefore not recommend.

Note: The recommend method wiring method, that causes a minimum amount of reflection, is daisy chaining where all receivers tapped from one transmission line needs only to be terminated twice.

C.3 RS-485 Data Flow Control

The RS-485 standard uses a single pair of wires to send and receive data. This line sharing requires some method to control the direction of the data flow. RTS (Request To Send) and CTS (Clear To Send) are the most commonly used methods.

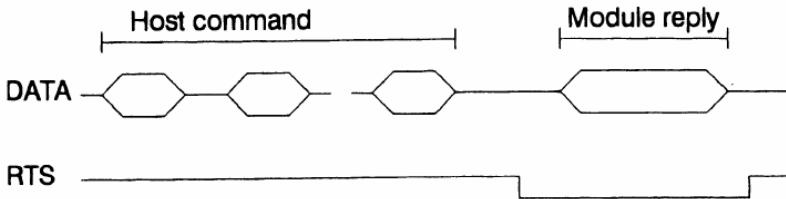

Figure C-6: RS-485 data flow control with RTS

Intelligent RS-485 Control

ADAM-4510 and ADAM-4520 are both equipped with an I/O circuit which can automatically sense the direction of the data flow. No handshaking with the host (like RTS, Request to Send) is necessary to receive data and forward it in the correct direction. You can use any software written for half-duplex RS-232 with an ADAM network without modification. The RS-485 control is completely transparent to the user.

Appendix D

Grounding Reference

Field Grounding and Shielding Application

Overview

Unfortunately, it's impossible to finish a system integration task at one time. We always meet some trouble in the field. A communication network or system isn't stable, induced noise or equipment is damaged or there are storms. However, the most usual issue is just simply improper wiring, ie, grounding and shielding. You know the 80/20 rule in our life: we spend 20% time for 80% work, but 80% time for the last 20% of the work. So is it with system integration: we pay 20% for Wire / Cable and 0% for Equipment. However, 80% of reliability depends on Grounding and Shielding. In other words, we need to invest more in that 20% and work on these two issues to make a highly reliable system. This application note brings you some concepts about field grounding and shielding. These topics will be illustrated in the following pages.

1. Grounding

- 1.1 The 'Earth' for reference
- 1.2 The 'Frame Ground' and 'Grounding Bar'
- 1.3 Normal Mode and Common Mode
- 1.4 Wire impedance
- 1.5 Single Point Grounding

2. Shielding

- 2.1 Cable Shield
- 2.2 System Shielding

3. Noise Reduction Techniques

4. Check Point List

D.1 Grounding

D-1.1 The 'Earth' for reference

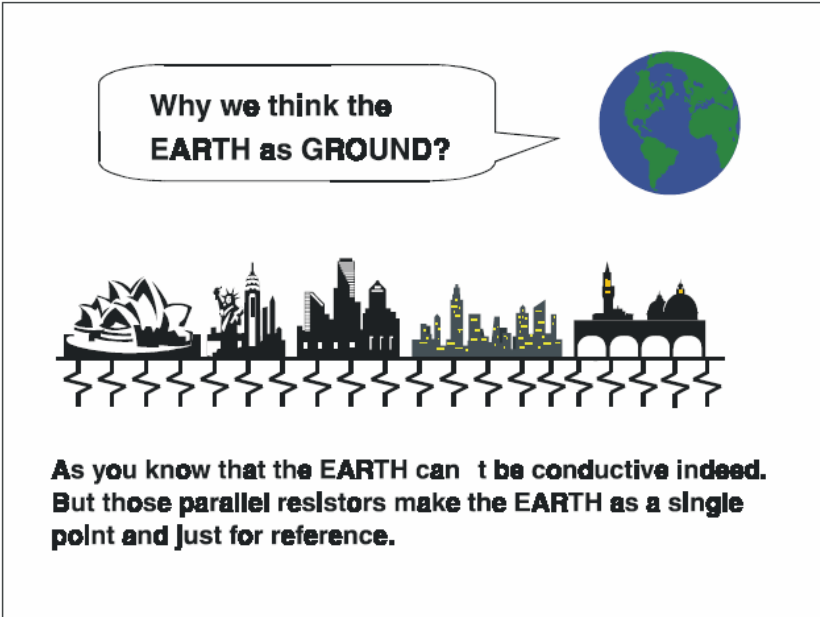

Figure D-1: Think the EARTH as GROUND.

As you know, the EARTH cannot be conductive. However, all buildings lie on, or in, the EARTH. Steel, concrete and associated cables (such as lightning arresters) and power system were connected to EARTH. Think of them as resistors. All of those infinite parallel resistors make the EARTH as a single reference point.

D-1.2 The 'Frame Ground' and 'Grounding Bar'

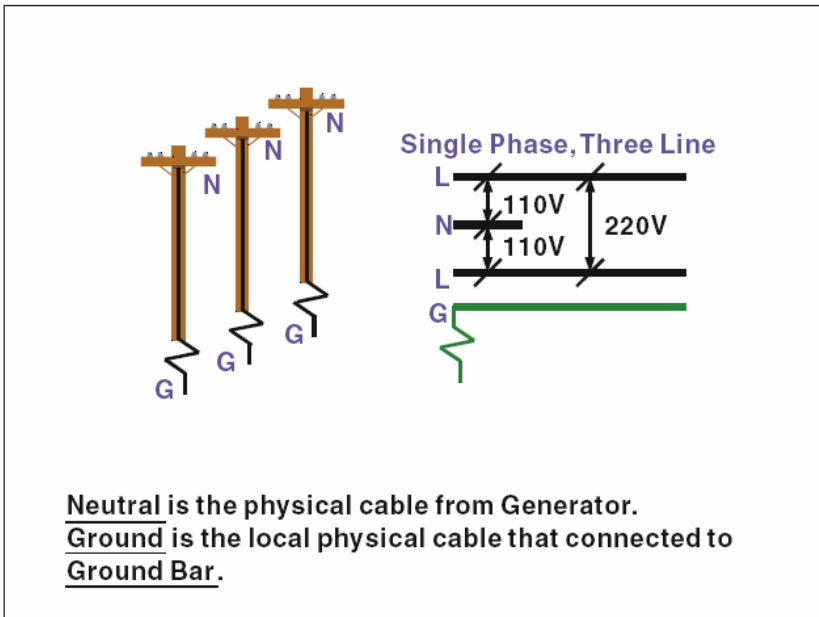
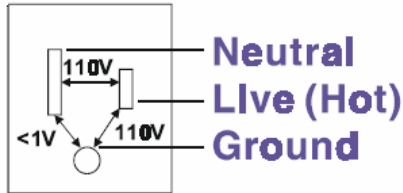

Figure D-2: Grounding Bar.

Grounding is one of the most important issues for our system. Just like Frame Ground of the computer, this signal offers a reference point of the electronic circuit inside the computer. If we want to communicate with this computer, both Signal Ground and Frame Ground should be connected to make a reference point of each other's electronic circuit. Generally speaking, it is necessary to install an individual grounding bar for each system, such as computer networks, power systems, telecommunication networks, etc. Those individual grounding bars not only provide the individual reference point, but also make the earth a our ground!

Normal Mode & Common Mode



Normal Mode: refers to defects occurring between the live and neutral conductors. Normal mode is sometimes abbreviated as NM, or L-N for live - to-neutral.

Common Mode: refers to defects occurring between either conductor and ground. It is sometimes abbreviated as CM, or N-G for neutral - to-ground.

Figure D-3: Normal mode and Common mode.

D-1.3 Normal Mode and Common Mode

Have you ever tried to measure the voltage between a live circuit and a concrete floor? How about the voltage between neutral and a concrete floor? You will get nonsense values. 'Hot' and 'Neutral' are just relational signals: you will get 110VAC or 220VAC by measuring these signals. Normal mode and common mode just show you that the Frame Ground is the most important reference signal for all the systems and equipments.

Normal Mode & Common Mode

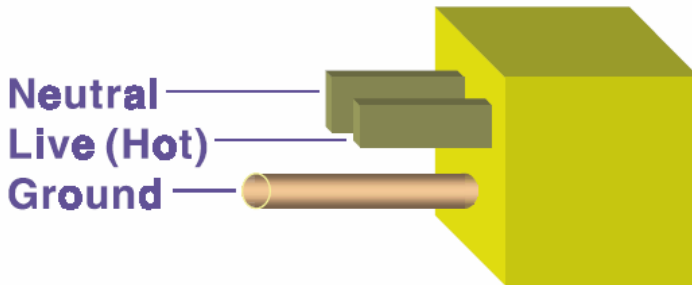

Ground-pin Is longer than others, for first contact to power system and noise bypass.

Neutral-pin Is broader than **Live-pin**, for reduce contacted Impedance.

Figure D-4: Normal mode and Common mode.

- Ground-pin is longer than others, for first contact to power system and noise bypass.
- Neutral-pin is broader than Live-pin, for reducing contact impedance.

D-1.4 Wire impedance

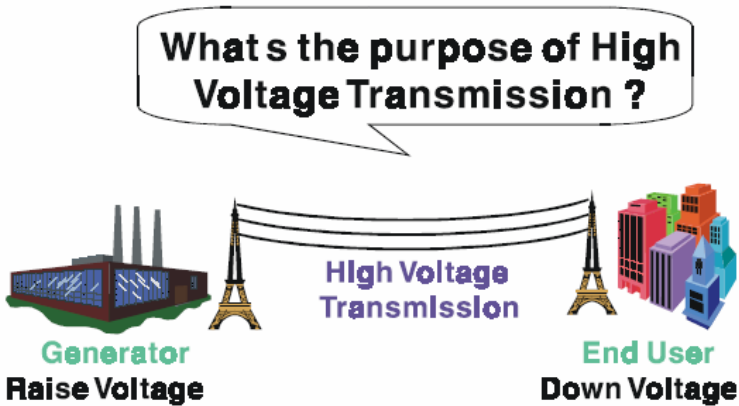

Referring to OHM rule, above diagram shows that how to reduce the power loss on cable.

Figure D-5: The purpose of high voltage transmission

- What's the purpose of high voltage transmission? We have all seen high voltage transmission towers. The power plant raises the voltage while generating the power, then a local power station steps down the voltage. What is the purpose of high voltage transmission wires ? According to the energy formula, $P = V * I$, the current is reduced when the voltage is raised. As you know, each cable has impedance because of the metal it is made of. Referring to Ohm's Law, ($V = I * R$) this decreased current means lower power losses in the wire. So, high voltage lines are for reducing the cost of moving electrical power from one place to another.

Wire Impedance

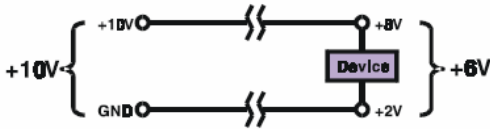

The wire impedance will consume the power.

Figure D-6: wire impedance.

D-1.5 Single Point Grounding

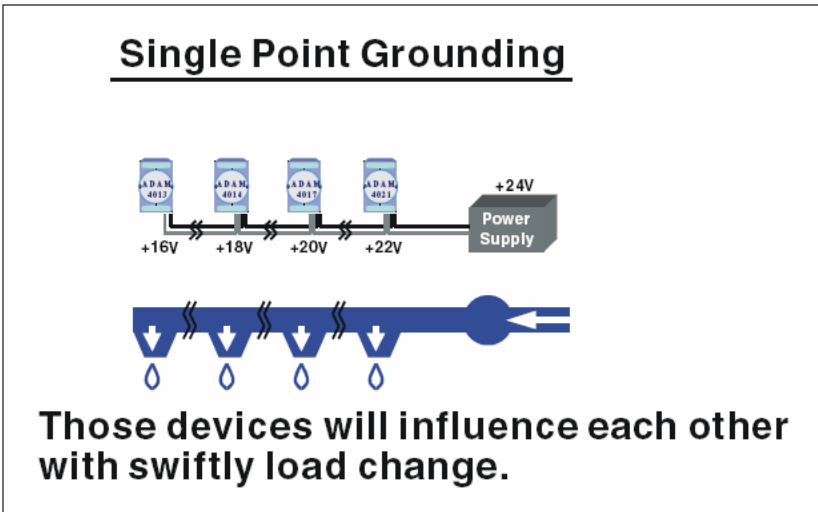

Figure D-7: Single point grounding. (1)

- What's Single Point Grounding? Maybe you have had an unpleasant experience while taking a hot shower in Winter. Someone turns on a hot water faucet somewhere else. You will be impressed with the cold water! The bottom diagram above shows an example of how devices will influence each other with swift load change. For example, normally we turn on all the four hydrants for testing. When you close the hydrant 3 and hydrant 4, the other two hydrants will get more flow. In other words, the hydrant cannot keep a constant flow rate.

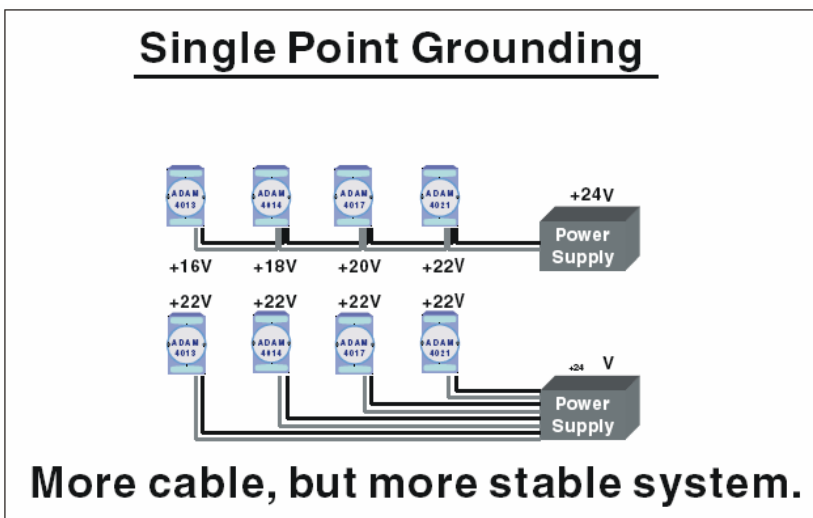

Figure D-8: Single point grounding. (2)

The above diagram shows you that a single point grounding system will be a more stable system. If you use thin cable for powering these devices, the end device will actually get lower power. The thin cable will consume the energy.

D.2 Shielding

D-2.1 Cable Shield

Single Isolated Cable

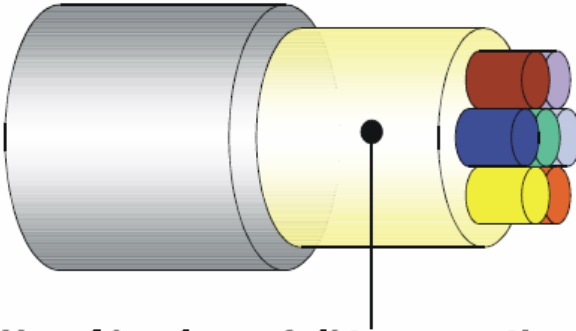

Use Aluminum foil to cover those wires, for isolating the external noise.

Figure D-9: Single isolated cable

- Single isolated cable The diagram shows the structure of an isolated cable. You see the isolated layer which is spiraled Aluminum foil to cover the wires. This spiraled structure makes a layer for shielding the cables from external noise.

Double Isolated Cable

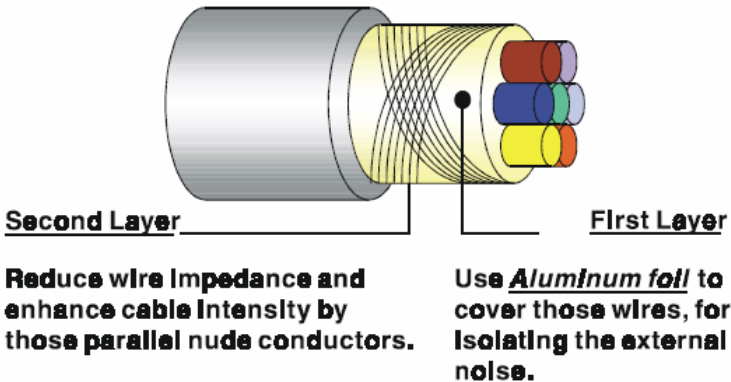

Figure D-10: Double isolated cable

- Double isolated cable Figure 10 is an example of a double isolated cable. The first isolating layer of spiraled aluminum foil covers the conductors. The second isolation layer is several bare conductors that spiral and cross over the first shield layer. This spiraled structure makes an isolated layer for reducing external noise. Additionally, follow these tips just for your reference.
- The shield of a cable cannot be used for signal ground. The shield is designed for carrying noise, so the environment noise will couple and interfere with your system when you use the shield as signal ground.
- The higher the density of the shield - the better, especially for communication network.
- Use double isolated cable for communication network / AI / AO.
- Both sides of shields should be connected to their frame while inside the device. (for EMI consideration)
- Don't strip off too long of plastic cover for soldering.

D-2.2 System Shielding

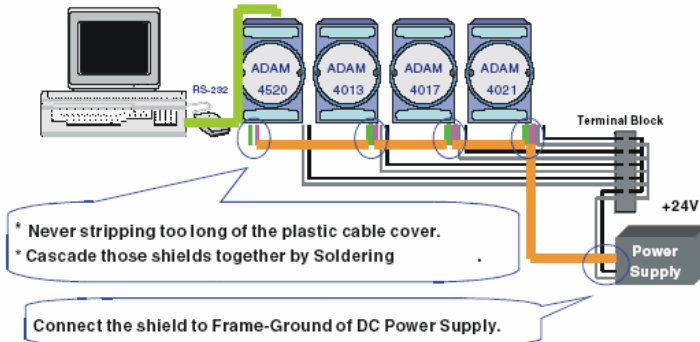
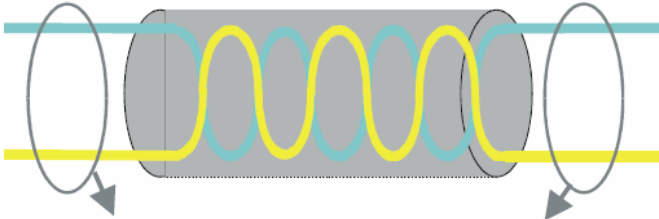

Figure D-11: System Shielding

- Never stripping too much of the plastic cable cover. This is improper and can destroy the characteristics of the Shielded-Twisted-Pair cable. Besides, the bare wire shield easily conducts the noise.
- Cascade these shields together by soldering. Please refer to following page for further detailed explanation.
- Connect the shield to Frame Ground of DC power supply to force the conducted noise to flow to the frame ground of the DC power supply. (The 'frame ground' of the DC power supply should be connected to the system ground)

Characteristic of Cable



This will destroy the twist rule.

Don't strip off too long of plastic cover for soldering, or will influence the characteristic of twisted pair cable.

Figure D-12: The characteristic of the cable

- The characteristic of the cable Don't strip off too much insulation for soldering. This could change the effectiveness of the Shielded-Twisted-Pair cable and open a path to introduce unwanted noise.

System Shielding

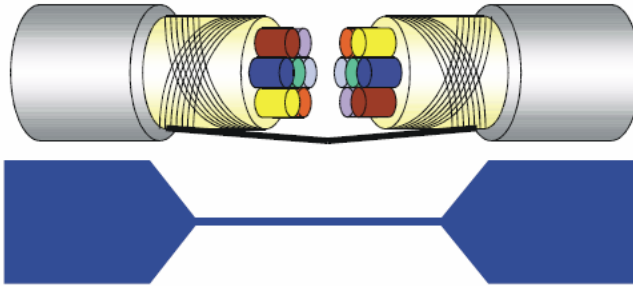

A difficult way for signal.

Figure D-13: System Shielding (1)

- Shield connection (1)

If you break into a cable, you might get in a hurry to achieve your goal. As in all electronic circuits, a signal will use the path of least resistance. If we make a poor connection between these two cables we will make a poor path for the signal. The noise will try to find another path for easier flow.

System Shielding

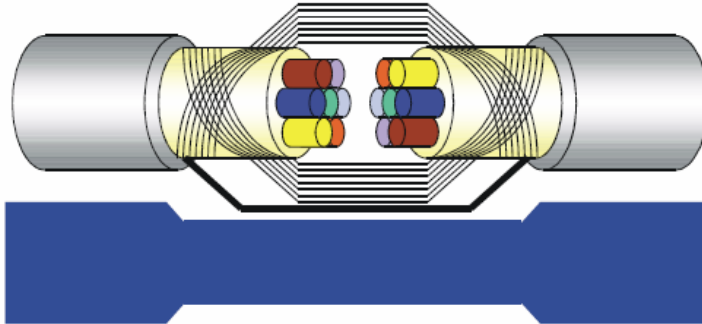

A more easy way for signal.

Figure D-14: System Shielding (2)

- Shield connection (2)

The previous diagram shows you that the fill soldering just makes an easier way for the signal.

D.3 Noise Reduction Techniques

- Isolate noise sources in shielded enclosures.
- Place sensitive equipment in shielded enclosure and away from computer equipment.
- Use separate grounds between noise sources and signals.
- Keep ground/signal leads as short as possible.
- Use Twisted and Shielded signal leads.
- Ground shields on one end ONLY while the reference grounds are not the same.
- Check for stability in communication lines.
- Add another Grounding Bar if necessary.
- The diameter of power cable must be over 2.0 mm².
- Independent grounding is needed for A/I, A/O, and communication network while using a jumper box.
- Use noise reduction filters if necessary. (TVS, etc)
- You can also refer to FIPS 94 Standard. FIPS 94 recommends that the computer system should be placed closer to its power source to eliminate load-induced common mode noise.

Noise Reduction Techniques

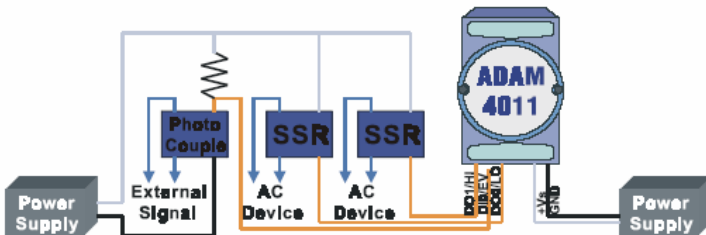

**Separate Load and Device power.
Cascade amplify/isolation circuit before
I/O channel.**

Figure D-15: Noise Reduction Techniques

D.4 Check Point List

- Follow the single point grounding rule?
- Normal mode and common mode voltage?
- Separate the DC and AC ground?
- Reject the noise factor?
- The shield is connected correctly?
- Wire size is correct?
- Soldered connections are good?
- The terminal screw are tight?

Appendix E

Reference Documents

Appendix E Reference Documents

Following resources are helpful for understanding how to use Multiprog Software and IEC-61131-3 programming languages.

E.1 Reference Documents

- Multiprog Quick Start Manual
- Multiprog User's Manual
- Multiprog On-line Help
- ADAM-5510KW Series User's Manual
(under Advantech Multiprog CD-ROM "Documentation" directory)
- ADAM-5510KW Series Startup Manual
(under Advantech Multiprog CD-ROM "Documentation" directory)
- ADAM-5000 I/O Module User's Manual
(under Advantech Multiprog CD-ROM "Documentation" directory)

E.2 Topics for Getting Familiar with Multiprog

- User Interfaces
- Basic Project Handling
- Text Editor, Graphical Editor and Edit Wizard
- Developing a Project
- Understanding the Architecture of Project
POUs
Instantiate
Task
- IEC-61131-3 Programming Languages
- Function Blocks and Functions
- PLC Help