

A horizontal line spans the width of the page above the title, and a vertical grey bar is positioned to the right of the title. The page is framed by four small squares at the corners.

User's Manual

Table of Contents

CHAPTER 1	
GETTING STARTED	1
Getting Started	2
Inventory	3
Safety and Maintenance	4
Checklists	5
Features	6
Where to Look For Information.....	6
Quick Start	7
Loading Windows	8
Turning off Your Computer	9
CHAPTER 2	
GETTING STARTED	11
Hardware and Software	12
Front View	13
Right View	14
Top View.....	15
Bottom View.....	16
LED Indicators.....	17
Quick Start Button	18
Touch Pen	19
CHAPTER 3	
MAKING CONNECTIONS	20
Right Side and Bottom Side Connectors.....	21
Left Side Connectors	22
Top Side Connectors	23
CHAPTER 4	
POWER MANAGEMENT AND USING SOFTWARE	24
Power Management	24
When to Replace the Battery	25
Heat Considerations	26
Using Software	27

APPENDIX A	
STATEMENTS	29
Statements	30
European Notice	31
Safety CAUTION	32
Battery Disposal	33
CAUTION FOR ADAPTER	33
BATTERY CAUTION	33
REGULATORY INFORMATION	34



Chapter 1
Introduction



Getting Started

Congratulations on your purchase of this Tablet PC. This Tablet PC is a fully functional PC with built-in wireless Connectivity. With your Tablet PC, you will be able to organize and access important business and personal information. In addition, you will be able to send and receive e-mail and access the Internet.

This Manual contains all the information you need to set up and use your Tablet PC. It describes all the features of the Tablet PC in an easy-to-read yet thorough manner.

Inventory

This Tablet PC is designed for years of productive and pleasurable computing. Use this section to keep details of your purchase. This information will be required should you need to make repairs to your Tablet PC during the warranty period. Update this section when you add new options.

DATE OF PURCHASE: _____

PLACE OF PURCHASE: _____

DEALER'S NAME: _____

DEALER'S ADDRESS: _____

TELEPHONE: _____

E-MAIL ADDRESS/WWW: _____

CONTACT PERSON: _____

MODEL NUMBER: _____

SERIAL NUMBER: _____

Safety and Maintenance

You can use your Tablet PC under a wide range of environmental conditions. However, to ensure long use and continued high performance, consider the following factors when setting up your Tablet PC:

- Follow all warnings and instructions noted in this documentation and in the Windows Help program.
- The first time you use your Tablet PC, we recommend that you carefully read the Making Connections section of this manual and initialize the battery to ensure optimum battery performance.
- Unplug the Tablet PC from the power outlet before cleaning. Use a damp cloth for cleaning. Do not use aerosols, solvents, or strong detergents.
- Slots and openings in the system cabinet are for ventilation purposes. Do not block or cover these openings or the system could overheat. Do not use or store the Tablet PC near a source of heat or dust.
- On the bottom of this Tablet PC, there is a label with information on the power requirements of this system. These requirements must be followed. If you are unsure of your local power supply, consult your dealer or local Power Company.
- Do not step on or place anything on the power cord.
- If you use the Tablet PC with an extension cord, ensure that the total ampere ratings of all the devices sharing the extension do not exceed the rating of the extension cord or the rating of the wall outlet.
- Never push foreign objects into the Tablet PC through any of the slots or openings. Dangerous voltages are present, which could cause electric shock or fire, or damage sensitive components.

Checklists

After opening the package, carefully inspect the contents. If any of the items is missing or appear damaged, contact your dealer. The shipping carton should contain the following:

STANDARD

- A Tablet PC with a hard disk drive
- Two standard battery packs
- An AC adapter with power cord
- Stylus

OPTIONS

The following items are normally optional, but some vendors may include them in the standard package. Some items may not be available in some countries, or some vendors may choose not to carry all the items.

- 1GB/2GB SODIMM memory card
- GPS/RFID/ Barcode modules



Caution: When purchasing any of the accessories listed above, purchase only those accessories that are approved for use with your Tablet PC. The above accessories are proprietary items. Your system vendor can obtain these approved accessories. If you use items that are not approved for use with this Tablet PC, you may cause your Tablet PC to malfunction, or to emit or receive electro-magnetic radiation in excess of local regulations. For non-proprietary accessories such as PC cards or printers, ensure that the accessory functions properly in your Tablet PC before making the purchase. Your system vendor may be able to recommend reliable brands and models.



Features

High performance Processors

Intel® Atom™ Processor Z530P (512K Cache, 1.60 GHz, 533 MHz FSB)

High Capacity Hard Disk Drive

The Tablet PC has a high capacity hard disk drive to store your favorite programs and large multimedia files.

Built-in Wireless LAN and LAN Capability

A built-in 802.11a/b/g/n and 10/100 Mbps Ethernet port allow you to access the Internet or a local area network (LAN).

Where to Look For Information

About Your Tablet PC

This User's Manual describes the key elements of your Tablet PC. New users can find a simple step-by-step orientation in the Quick Start section of this chapter.

About Windows XP

Windows Online Help, found on the Start menu, offers extensive Windows assistance. **Windows XP Tour** offers an online orientation for new Windows users.

Find it in:

Start/ Programs/ Accessories/ Tour Windows XP

Quick Start

Turning on the Tablet PC for the First Time

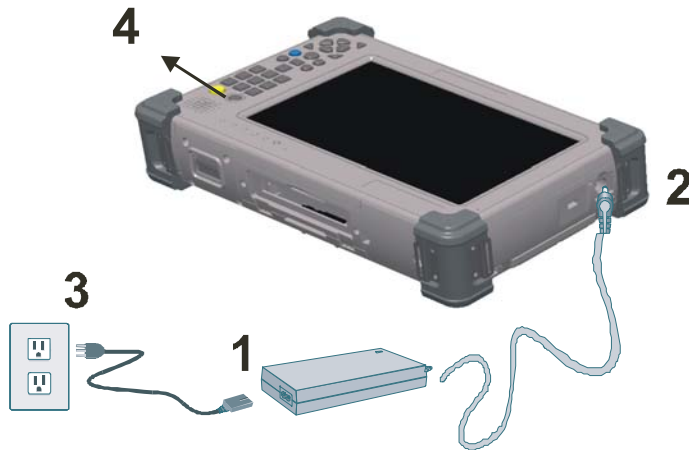

1. Connect the AC adapter power cord to the AC adapter.
2. Connect the AC adapter to the DC power port on the left side of your Tablet PC.
3. Connect the AC adapter power cord to an AC outlet.
4. Press the power button to turn on the power.



Note: The battery is not fully charged. Allow your battery to fully charge before using it (i.e., before disconnecting AC power).

Loading Windows

The following section is for installing the Windows operating system only. If you are installing a different operating system, please check with your vendor for installation details.

Your Tablet PC will begin loading Windows once you turn on the power. Wait a few seconds for Windows setup to load. The Windows setup will prompt you for the product key number, shown to the right:



Product key number

Note: The product key is on a sticker attached to the bottom of the Tablet PC.

1. Type your name, and, if applicable, the name of your company.
2. Read the End User's License Agreement. Click **Next** to accept it.
3. Enter the product key number. You can find this on the Certificate of Authenticity on a sticker attached to the Tablet PC. Click **Finish**.
4. The Start Wizard will prompt you to set the date, and your local time.

After the Start Wizard updates your system settings, the Welcome to Windows screen will appear. You may disable this feature by clearing the check box labeled **show this screen each time Windows starts**.

Some software comes preloaded with Windows. New users can familiarize themselves with this software by selecting Programs from the start menu, then clicking on programs to run them.

Turning off Your Tablet PC

Turning off the Tablet PC properly is important to maintaining your Tablet PC.

1. On the Start menu, click **Turn off Computer**.

2. Click **Turn Off** in below Windows screen.

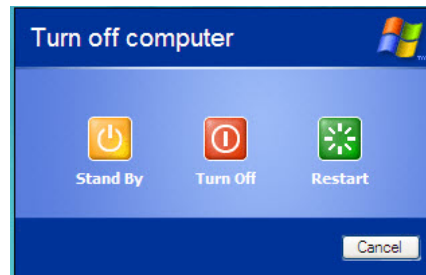
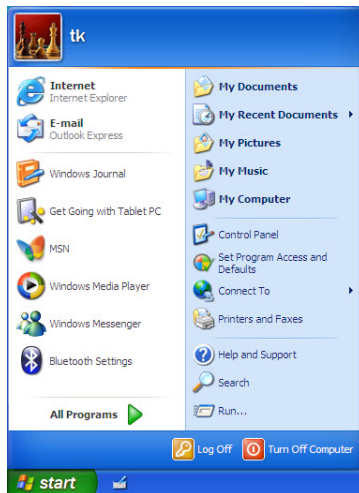

If you are going to be away from the Tablet PC for a short period, there are ways of conserving power without shutting down the system.



Warning: Shutting off the Tablet PC improperly may result in data loss.

Chapter 2
Getting Started



Hardware and Software

This chapter introduces the different components and controls of your Tablet PC, including the hardware components, the software, and the audio and video systems.

Getting Started

Before you begin using your Tablet PC, read this chapter to familiarize yourself with the main components installed in the system.

Front View

1. Microphone
2. Light sensor
3. LED indicators
4. Speaker
5. Keypad

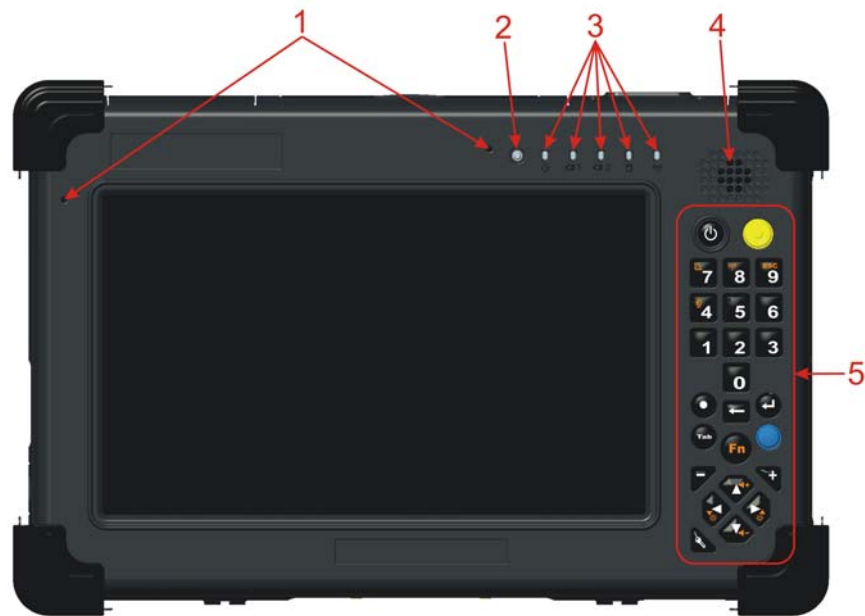

Right View

1. Microphone jack
2. Headphone jack
3. USB port
4. RJ-45 jack
5. USB port
6. Docking connector



Top View

1. SD card slot
2. PCMCIA slot

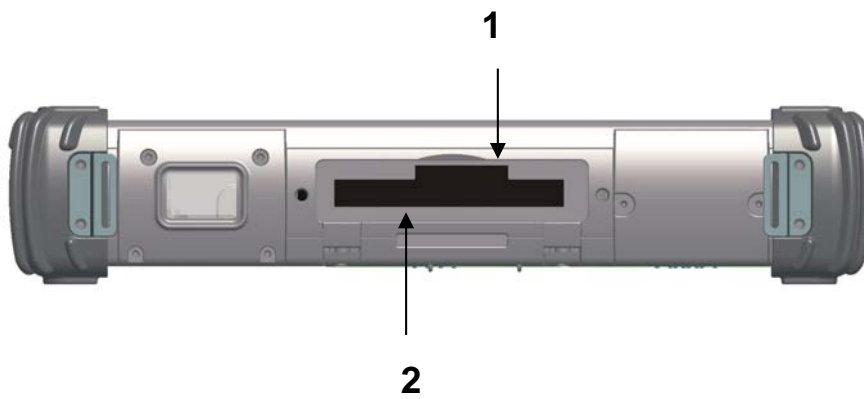

Left View

1. Security lock slot
2. DC-IN jack

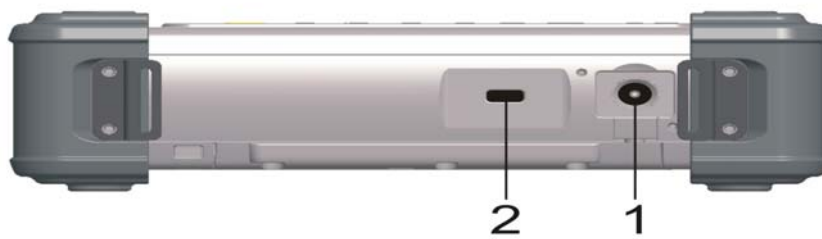



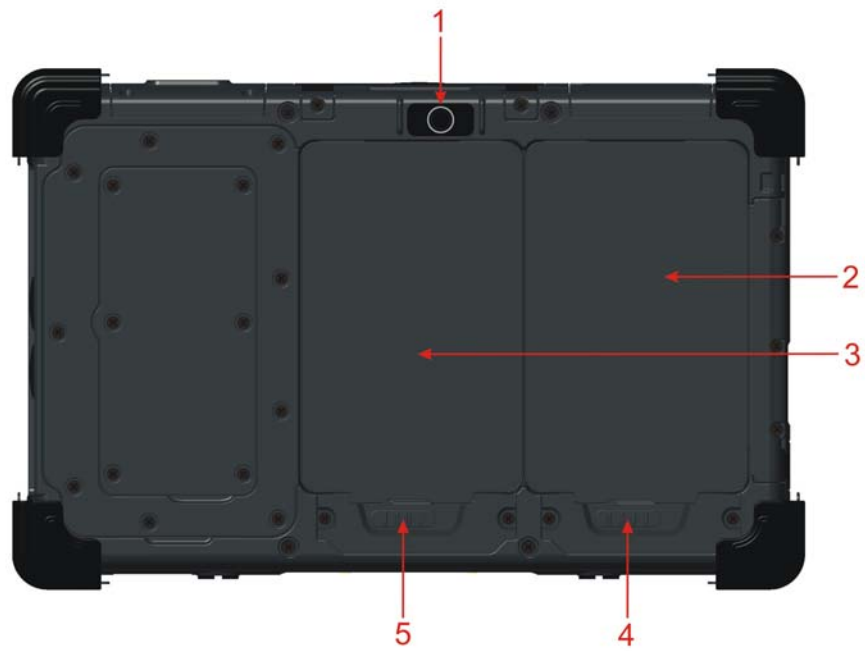

Bottom View

1. Camera
2. Battery1
3. Battery2
4. Battery1 latch
5. Battery2 latch















LED Indicators

Icon	Light	Description
	No light	WLAN is Not powered and Bluetooth is Not powered
	Blue	WLAN or Bluetooth is enabled
	Green	Tablet PC is reading from, or writing to the built-in hard disk.
 1	Green	Battery is fully charged
	Orange	Battery is being charged
	 2	Flashing Red
	Green	Power is on
	Flashing Green	System is in standby mode

Front View Buttons

There are 25 keys located at the right side of front panel, their functions are as follows:

Icon	Function
	Power Button Press it to turn on/off the system.
	Yellow Button To trigger Barcode scan function
	Numeric Key Same function as on a standard keyboard.
	Decimal-point Key Same function as on a standard keyboard.
	Backspace Button Same function as on a standard keyboard

	Enter Button Same function as on a standard keyboard.
	Tab Button Same function as on a standard keyboard.
	Function Button Access to secondary operation of some buttons (shown in the illustration above)
	Blue Button Can be assigned to launch specific windows base program as a quick-launcher
	Plus/Minus Button Same function as on a standard keyboard.
	UP/ Down/ Left/ Right Button Same function as on a standard keyboard.
	Security Button Similar function as pressing Ctrl+Alt+Delete on a standard keyboard.

Function Keys

Hold the Fn key while pressing the function key.

Function key	Description
Fn + Up	Volume up
Fn + Down	Volume down
Fn + Left	Brightness Decrease
Fn + Right	Brightness Increase
Fn + 4	Trigger keypad LED backlight
Fn + 7	Screen Rotate by 90-degree
Fn + 8	Turn on/off WLAN and Bluetooth devices
Fn + 9	Escape same as standard Keyboard



Chapter 3

**Making
Connections**

Making Connections

Your Tablet PC is equipped with a full array of ports and connectors, including standard input/output (I/O) ports for quickly and easily adding peripheral devices.

Right Side and Bottom Side Connectors



1. Microphone-in Jack

Connect a microphone to this jack to record audio.

2. Headphone Jack

Connect a stereo headset or external speakers to this jack to listen to multimedia.

3. & 5. USB (Universal Serial Bus) Ports

The Universal Serial Bus (USB) is the latest standard for attaching monitors, input devices, scanners, and other devices to a PC. USB devices can be chained together on a single cable.

4. LAN RJ-45 Jack

With the built-in Ethernet LAN, you can make LAN connection without installing PC cards. Connection speed is 10/100 Mbps.

6. Multi IO connector

The Connector is reserved for specific purpose which is used to connect to customer's device.

Left Side Connectors

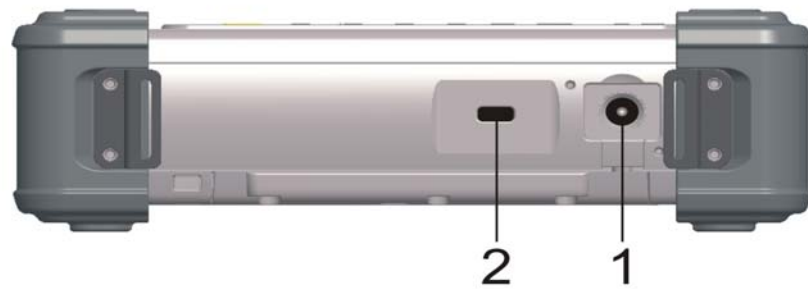

1. DC-IN Jack

Connect with the attached AC adapter

2. Security Lock Slot

Install an antitheft device to this lock.

3. Top Side Connectors

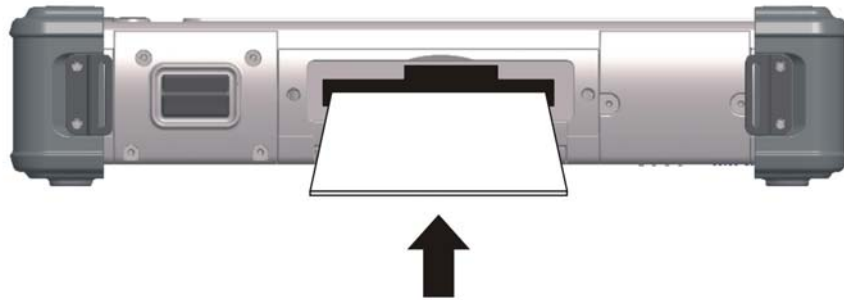

1. PC Card Slot (PCMCIA)

Insert a PC Card (PCMCIA) card in the PC Card Slot as shown above until it snaps into place. Press the eject button to release the card.

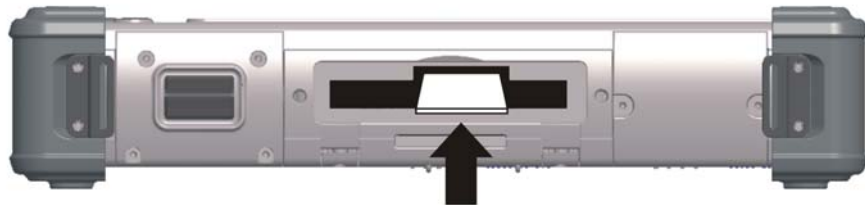

2. SD Card slot

The SD Card slot can be used as an interface between your Tablet PC and a variety of devices. Insert an SD card in the SD card slot as shown above until it snaps into place.

Chapter 4
Power Management
And Using Software

Power Management

Checking the Battery Level

You can check the remaining battery power in the Windows® battery status indicator located at the lower right-hand corner of the task tray. The Battery Status icon only appears in the task tray while the unit is running on the battery power but not while the unit is running off an external power source through the AC adaptor.



Enter Monitoring Battery Power

There are two ways to monitor how much power the battery has left.

1. Click Start / Control Panel / Power Options then click Power Meter.
2. Moving the cursor to the battery icon on the taskbar is the simplest way to check on battery power status.



If you do not see the battery icon, enable it in **Start / Control Panel / Power Options**. Choose the Advanced tab and click “Always show icon on the taskbar.”

Low Battery Alarms

How your Tablet PC responds to a low battery condition is set under **Start / Control Panel / Power Options / Alarms**.

Two different power alarms can be enabled or disabled: the Low Battery Alarm, and the Critical Battery Alarm.



Warning: When battery power is low, the battery indicator will flash red, and the alarm will display a warning on your screen. Take immediate action, such as saving files or connecting to the AC adapter, or data may be lost.

Battery Charging

When you use the AC adapter to connect your Tablet PC to a power outlet, the internal battery will automatically begin to recharge. While the battery is charging, the Battery Charge icon on the Indicator panel will be active after 6~12 seconds. When the battery is fully charged, the Battery Charge icon will become Green.

If your Tablet PC is turned off, a fully discharged battery will take about 4 hours to recharge.

Refer to the following table:

Two Battery Packs	Charging Time
System On (Under Screen Saver Mode)	Approx. 8 hours
System Off (suspend to RAM)	Approx. 4 hours

When to Replace the Battery Pack

Over time, the battery's capacity gradually decreases. We recommend that you replace your battery pack when you notice that it begins to store significantly less charge.

Changing the Battery Pack

1. Slide the battery release latch,
2. Then remove the battery,
3. Align the back side of the battery pack with the battery bay and press the top side of battery pack to install it,
4. Move the latch to lock back into position.

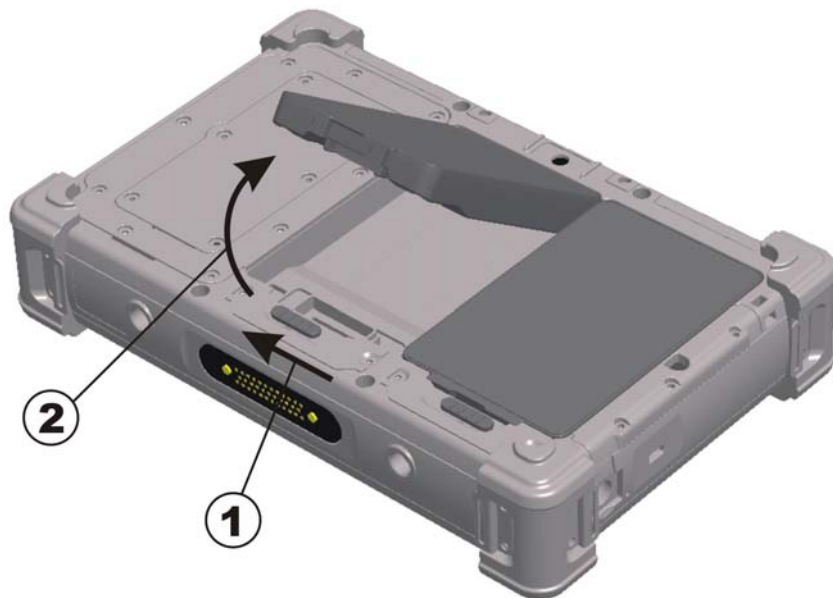

Heat Considerations

The Tablet PC processor has been specially designed to consume little power, and generates very little heat. However, working in a hot environment, or working for long periods may raise the temperature. If the temperature continues to rise, processor activity will be reduced. You may notice a slight loss of performance when this happens.

Using Software

Digitizer Calibration <For Selected Model>

The touch screen is a thin membrane on the top of the LCD that responds to mechanical pressure on the screen's surface. The cursor on the screen is controlled by the stylus. If you notice the stylus tip touch-point not matching up with the cursor, you can recalibrate the touch screen.

Calibrating the Digitizer

1. Click the Windows® Start button > Control Panel > Switch to Classic View > Pen Tablet Properties > Calibrate.
2. Under the Setting tab, click on the [Calibrate...] button to activate the calibration screen.



3. Hold the pen and position your head as you normally do when working with the tablet.
4. Use the pen tip to click on the center of the crosshairs. The wheel moves to another location on-screen.
5. Click [OK] to accept the calibration.

Calibrating the Touch Screen

1. Click the Windows® Start button > Control Panel > Switch to Classic View > Touch Settings.
2. Under the calibration tab, click on the [Calibrate...] button to activate the calibration screen.
3. Hold the pen and position your head as you normally do when working with the tablet.
4. Use the pen tip to click on the center of the crosshairs. The wheel moves to another location on-screen.
5. Test the alignment by positioning the pen at a few different points on the display. Click [Finished] to accept the calibration. Click [Try Again] to recalibrate.
6. Be sure to read the directions in the calibration screen for detailed instructions and additional options.

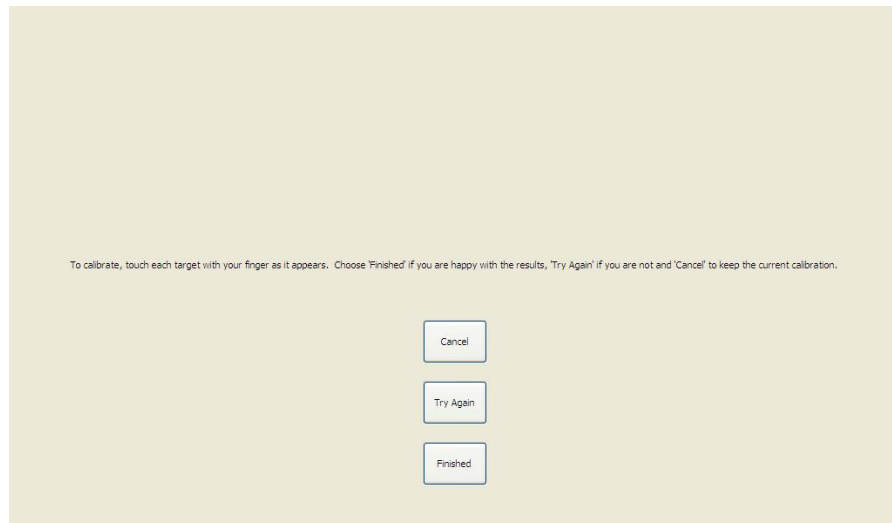

Appendix A
Statements

Statements

Federal Communications Commission Statement

This equipment has been tested and found to comply with the limits for a Class B digital device, pursuant to Part 15 of the FCC Rules. These limits are designed to provide reasonable protection against harmful interference in a residential installation. This equipment generates, uses, and can radiate radio frequency energy and, if not installed and used in accordance with the instructions, may cause harmful interference to radio communications. However, there is no guarantee that interference will not occur in a particular installation. If this equipment does cause harmful interference to radio or television reception, which can be determined by turning the equipment off and on, the user is encouraged to try to correct the interference by one or more of the following measures:

1. Reorient or relocate the receiving antenna.
2. Increase the separation between the equipment and the receiver.
3. Connect the equipment into an outlet on a circuit different from that to which the receiver is connected.
4. Consult the dealer or an experienced radio/TV technician for help.

Shielded interconnect cables and shielded AC power cable must be employed with this equipment to insure compliance with the pertinent RF emission limits governing this device. Changes or modifications not expressly approved by the system's manufacturer could void the user's authority to operate the equipment.



CAUTION

Any changes or modifications not expressly approved by the party responsible for compliance could void the user's authority to operate the equipment.

RF exposure warning

The equipment complies with FCC RF exposure limits set forth for an uncontrolled environment. The equipment must not be co-located or operating in conjunction with any other antenna or transmitter.

Radiation Exposure Statement:



This equipment complies with FCC radiation exposure limits set forth for an uncontrolled environment. End users must follow the specific operating instructions for satisfying RF exposure compliance. To maintain compliance with FCC RF exposure compliance requirements, please follow operation instruction as documented in this manual.

According to FCC 15.407(e), the device is intended to operate in the frequency band of 5.15GHz to 5.25GHz under all conditions of normal operation. Normal operation of this device is restricted to indoor used environment only

The availability of some specific channels and/or operational frequency bands are country dependent and are firmware programmed at the factory to match the intended destination. The firmware setting is not accessible by the end user.

Declaration of Conformity

This device complies with part 15 of the FCC rules. Operation is subject to the following conditions:

- This device may not cause harmful interference
- This device must accept any interference received, including interference that may cause undesired operation.

European Notice

CE Declaration of Conformity

For the following equipment: Tablet built-in 802.11a/b/g/n WLAN module

Is herewith confirmed to comply with the requirements set out in the Council Directive on the Approximation of the Laws of the Member

States relating to Electromagnetic Compatibility (2004/105/EC), Low-voltage Directive (2006/95/EC) , the procedures given in European Council Directive 1999/5/EC .

The equipment was passed. The test was performed according to the following European standards:

- EN 300 328 V.1.4.1 (2003-04)
- EN 301 489-1 V.1.3.1 (2001-09) / EN 301 489-17 V.1.1.1 (2000-09)
- EN 301 893 V.1.2.2 (2003-06)
- EN 50371: 2002
- EN 60950: 2000

Regulatory statement (R&TTE / WLAN IEEE 802.11b & 802.11g)

European standards dictate maximum radiated transmit power of 100mW EIRP and frequency range 2.400-2.4835GHz; In France, the equipment must be restricted to the 2.4465-2.4835GHz frequency range and must be restricted to indoor use.

Safety Caution

To reduce the risk of fire, use only No. 26 AWG or larger telecommunication line cord.

IMPORTANT SAFETY INSTRUCTIONS

When using your telephone equipment, basic safety precautions should always be followed to reduce the risk of fire, electric shock and injury to persons, including the following:

Do not use this product near water, for example, near a bathtub, wash bowl, kitchen sink or laundry tub, in a wet basement or near a swimming pool.

Avoid using a telephone (other than a cordless type) during an electrical storm. There may be a remote risk of electric shock from lightning.

Do not use the telephone to report a gas leak in the vicinity of the leak.

Use only the power cord and batteries indicated in this manual. Do not dispose of batteries in a fire. They may explode. Check with local codes for possible special disposal instructions.

Battery Disposal

THIS PRODUCT CONTAINS LITHIUM-ION BATTERY PACKS. IT MUST BE DISPOSED OF PROPERLY. CONTACT LOCAL ENVIRONMENTAL AGENCIES FOR INFORMATION ON RECYCLING AND DISPOSAL PLANS IN YOUR AREA.

CAUTION FOR ADAPTER

THIS TABLET PC IS FOR USE WITH MODEL NO. FSP065-RAB

BATTERY CAUTION

DANGER OF EXPLOSION IF BATTERY IS INCORRECTLY REPLACED.

REPLACE ONLY WITH THE SAME OR EQUIVALENT TYPE RECOMMENDED BY THE MANUFACTURER. DISPOSE OF USED BATTERIES ACCORDING TO THE MANUFACTURER'S INSTRUCTIONS.

Regulatory information / Disclaimers

Installation and use of this Wireless LAN device must be in strict accordance with the instructions included in the user documentation provided with the product. Any changes or modifications (including the antennas) made to this device that are not expressly approved by the manufacturer may void the user's authority to operate the equipment. The manufacturer is not responsible for any radio or television interference caused by unauthorized modification of this device, or the substitution of the connecting cables and equipment other than manufacturer specified. It is the responsibility of the user to correct any interference caused by such unauthorized modification, substitution or attachment. Manufacturer and its authorized resellers or distributors will assume no liability for any damage or violation of

government regulations arising from failing to comply with these guidelines.

IMPORTANT NOTE (CO-LOCATION)

FCC RF Radiation Exposure Statement: This equipment complies with FCC RF radiation exposure limits set forth for an uncontrolled environment. This device and its antenna must not be co-located or operating in conjunction with any other antenna or transmitter.

Radio Frequency Interference Requirements

This device is restricted to INDOOR USE due to its operation in the 5.15 to 5.25GHz frequency range. According to FCC 15.407(e), requires this product to be used indoors for the frequency range 5.15 to 5.25GHz to reduce the potential for harmful interference to co-channel of the Mobile Satellite Systems.

High power radars are allocated as primary user of the 5.25 to 5.35GHz and 5.65 to 5.85GHz bands. These radar stations can cause interference with and / or damage this device

SAR Exposure

This device has been tested for compliance with FCC RF Exposure (SAR) limits in typical flat configurations.

Please refer to the SAR test report that was uploaded at FCC website.

WLAN

“To prevent radio interference to the licensed service, this device is intended to be operated indoors and away from windows to provide maximum shielding. Equipment (or its transmit antenna) that is installed outdoors is subject to licensing.”

Please note that the manufacturer must guarantee that it has no Ad-hoc capability for 5250~5350 and 5470~5725 MHz frequency band.

For LPD

“Operation is subject to the following two conditions: (1) this device may not cause interference, and (2) this device must accept any

interference, including interference that may cause undesired operation of the device.”

W/detachable antenna

“To reduce potential radio interference to other users, the antenna type and its gain should be so chosen that the equivalent isotropically radiated power (EIRP) is not more than that required for successful communication.”