

Dimension

L	*	W	*	H
325	*	107	*	41 (1U) mm
12.8	*	4.21	*	1.61 (1U) inch



Features

- Universal AC input / Full range
- Built-in active PFC function
- High efficiency up to 94.5%
- Forced air cooling by built-in DC fan
- Output voltage and constant current level programmable
- Built-in OR-ing FET, support hot swap (hot plug)
- Active current sharing up to 12800W for one 19" rack shelf
- Built-in I²C interface, support PMBus protocol (Optional CANBus protocol)
- Protections: Short circuit / Overload / Over voltage / Over temperature
- Optional conformal coating
- 5 years warranty

Description

DRP-3200 is a 3.2KW single output rack mountable front end AC/DC power supply with 1U low profile and high power density up to 37W/inch³. This series operates at 90~264VAC input voltage and offers the models with the DC output mostly demanded by the industry. Each model is cooled by the built-in DC fan with fan speed control and working for the temperature up to 70°C. DRP-3200 provides vast design flexibility by equipping various built-in functions such as the PMBus communication protocol, output programming, active current sharing (up to 25600W via two 19" rack shelves, DHP-1UT), remote ON/OFF control, auxiliary power, alarm signal, and etc. Maximum number that can be monitored by master controller in communication shall be 8 power supplies.

Model Encoding / Order Information

DRP - 3200 - 24

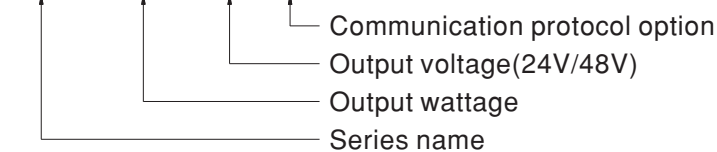

- ※ Note 1: 19" rack shelf, DHP-1UT, available. Details available on <http://www.meanwell.com/>
- ※ Note 2: Control/Monitor unit, RKP-CMU1, available. Details available on <http://www.meanwell.com/>

Type	Communication Protocol	Note
Blank	PMBus protocol	In Stock
CAN	CANBus protocol	By request

SPECIFICATION

MODEL		DRP-3200-24	DRP-3200-48	
OUTPUT	DC VOLTAGE	24V	48V	
	RATED CURRENT	133A	67A	
	CURRENT RANGE	0 ~ 133A	0 ~ 67A	
	RATED POWER	3192W	3216W	
	RIPPLE & NOISE (max.) <small>Note.2,3</small>	300mVp-p	480mVp-p	
	VOLTAGE ADJ. RANGE	23.5 ~ 30V	47.5 ~ 58.8V	
	VOLTAGE TOLERANCE <small>Note.4</small>	± 1.0%	± 1.0%	
	LINE REGULATION	± 0.5%	± 0.5%	
	LOAD REGULATION	± 0.5%	± 0.5%	
	SETUP, RISE TIME	1500ms, 60ms/230VAC at full load		
HOLD UP TIME (Typ.)	16ms / 230VAC at 75% load	9ms / 230VAC at full load		
INPUT	VOLTAGE RANGE <small>Note.5</small>	90 ~ 264VAC	127 ~ 370VDC	
	FREQUENCY RANGE	47 ~ 63Hz		
	POWER FACTOR (Typ.)	0.97/230VAC at full load		
	EFFICIENCY (Typ.) <small>Note.6</small>	93.5%	94.5%	
	AC CURRENT (Typ.) <small>Note.5</small>	17A/230VAC		
	INRUSH CURRENT (Typ.)	COLD START 55A/230VAC		
	LEAKAGE CURRENT	<1.5mA / 230VAC		
PROTECTION	OVERLOAD	105 ~ 115% rated output power Protection type : Constant current limiting, shut down O/P voltage 5 sec. after O/P voltage is down low, re-power on to recover		
	OVER VOLTAGE	31.5 ~ 37.5V	63 ~ 75V	
	OVER TEMPERATURE	Shut down o/p voltage, recovers automatically after temperature goes down		
FUNCTION	OUTPUT VOLTAGE PROGRAMMABLE(PV)	Adjustment of output voltage is allowable to 50 ~ 125% of nominal output voltage Please refer to the Function Manual in following pages		
	CONSTANT CURRENT LEVEL PROGRAMMABLE(PC)	Adjustment of constant current level is allowable to 20 ~ 100% of rated current. Please refer to the Function Manual in following pages		
	REMOTE ON-OFF CONTROL	By electrical signal or dry contact Power ON:short Power OFF:open. Please refer to the Function Manual in following pages		
	REMOTE SENSE	Compensate voltage drop on the load wiring up to 0.5V. Please refer to the Function Manual in following pages		
	AUXILIARY POWER	5V @ 0.3A, tolerance ± 10%, ripple 150mVp-p, 12V @ 0.8A, tolerance ± 10%, ripple 450mVp-p		
	ALARM SIGNAL	Isolated TTL signal output for T-Alarm, AC-OK and DC-OK. Please refer to the Function Manual in following pages		
ENVIRONMENT	WORKING TEMP.	-30 ~ +70°C (Refer to "Derating Curve")		
	WORKING HUMIDITY	20 ~ 90% RH non-condensing		
	STORAGE TEMP., HUMIDITY	-40 ~ +85°C, 10 ~ 95% RH non-condensing		
	TEMP. COEFFICIENT	± 0.03%/°C (0 ~ 50°C)		
	VIBRATION	10 ~ 500Hz, 2G 10min./1cycle, 60min. each along X, Y, Z axes		
SAFETY & EMC (Note 8)	SAFETY STANDARDS	UL62368-1, CSA C22.2 No. 62368-1, TUV BS EN/EN62368-1, EAC TP TC 004 approved		
	WITHSTAND VOLTAGE	I/P-O/P:3KVAC I/P-FG:2KVAC O/P-FG:1.5KVAC		
	ISOLATION RESISTANCE	I/P-O/P, I/P-FG, O/P-FG:100M Ohms / 500VDC / 25°C / 70% RH		
	EMC EMISSION	Parameter	Standard	Test Level / Note
		Conducted	BS EN/EN55032 (CISPR32)	Class B
Radiated		BS EN/EN55032 (CISPR32)	Class A	
Harmonic Current		BS EN/EN61000-3-2	-----	
EMC IMMUNITY	Voltage Flicker	BS EN/EN61000-3-3	-----	
	BS EN/EN55024, BS EN/EN61000-6-2			
	Parameter	Standard	Test Level / Note	
	ESD	BS EN/EN61000-4-2	Level 3, 8KV air ; Level 2, 4KV contact	
	Radiated	BS EN/EN61000-4-3	Level 3	
	EFT / Burst	BS EN/EN61000-4-4	Level 3	
	Surge	BS EN/EN61000-6-2	2KV/Line-Line 4KV/Line-Earth	
	Conducted	BS EN/EN61000-4-6	Level 3	
Magnetic Field	BS EN/EN61000-4-8	Level 4		
Voltage Dips and Interruptions	BS EN/EN61000-4-11	>95% dip 0.5 periods, 30% dip 25 periods, >95% interruptions 250 periods		
OTHERS	MTBF	176.1K hrs min. Telcordia SR-332 (Bellcore) ; 44.5K hrs min. MIL-HDBK-217F (25°C)		
	DIMENSION	325*107*41mm (L*W*H)		
	PACKING	2.65Kg;4pcs/11.6Kg/0.87CUFT		
NOTE	<p>1. All parameters NOT specially mentioned are measured at 230VAC input, rated load and 25°C of ambient temperature.</p> <p>2. Ripple & noise are measured at 20MHz of bandwidth by using a 12" twisted pair-wire terminated with a 0.1uf & 47uf parallel capacitor.</p> <p>3. Under variable load application or parallel operation ripple of the output voltage may be higher than the SPEC at light load condition. It will go back to normal ripple level once the output load is more than 5%.</p> <p>4. Tolerance : includes set up tolerance, line regulation and load regulation.</p> <p>5. Derating may be needed under low input voltages. Please check the derating curve for more details.</p> <p>6. The efficiency is measured at 75% load.</p> <p>7. If use PV signal to adjust Vo, under certain operating conditions, ripple noise of Vo might slightly go over rating defined in this specification.</p> <p>8. The power supply is considered a component which will be installed into a final equipment. All the EMC tests are been executed by mounting the unit on a 600mm*900mm metal plate with 1mm of thickness. The final equipment must be re-confirmed that it still meets EMC directives. For guidance on how to perform these EMC tests, please refer to "EMI testing of component power supplies." (as available on http://www.meanwell.com)</p> <p>9. The ambient temperature derating of 3.5°C/1000m with fanless models and of 5°C/1000m with fan models for operating altitude higher than 2000m(6500ft).</p> <p>※ Product Liability Disclaimer : For detailed information, please refer to https://www.meanwell.com/serviceDisclaimer.aspx</p>			

■ BLOCK DIAGRAM

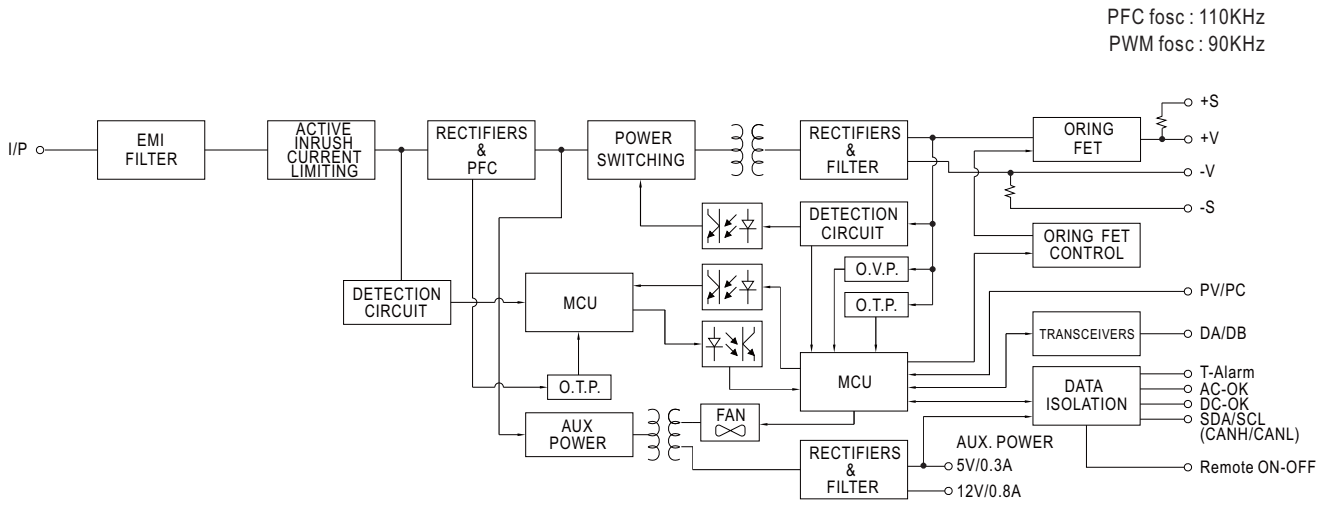

■ STATIC CHARACTERISTICS

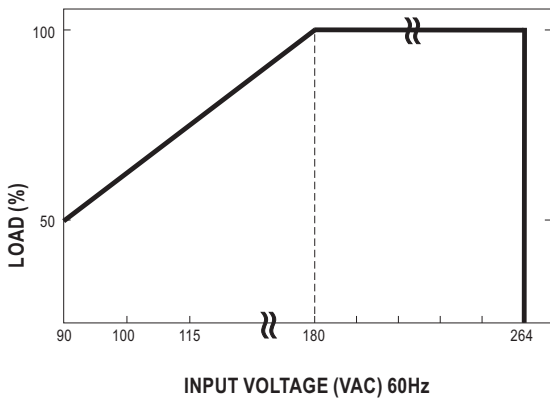

■ DERATING LOADs vs INPUT VOLTAGE

INPUT \ MODEL	24V	48V
180~305VAC	3192W 133A	3216W 67A
90VAC	1596W 66.5A	1608W 33.5A

■ DERATING CURVE

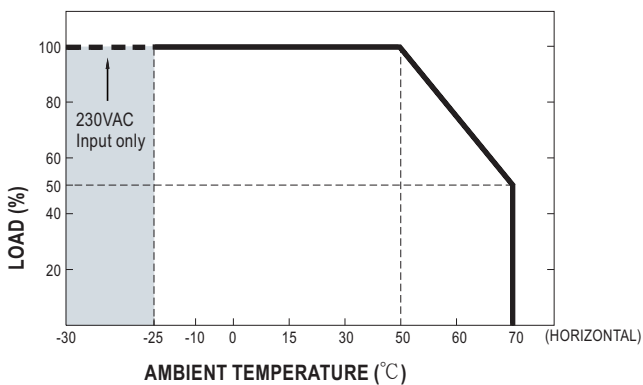

■ EFFICIENCY vs LOAD (48V MODEL)

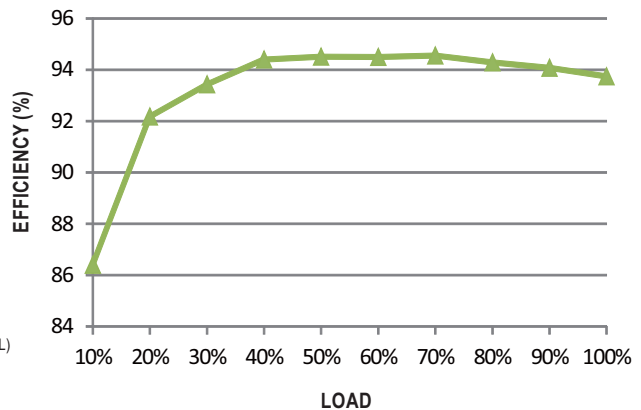

⊙ The curve above is measured at 230VAC.

FUNCTION MANUAL

1. Voltage Drop Compensation

1.1 Remote Sense

※ The Remote Sense compensates voltage drop on the load wiring up to 0.5V

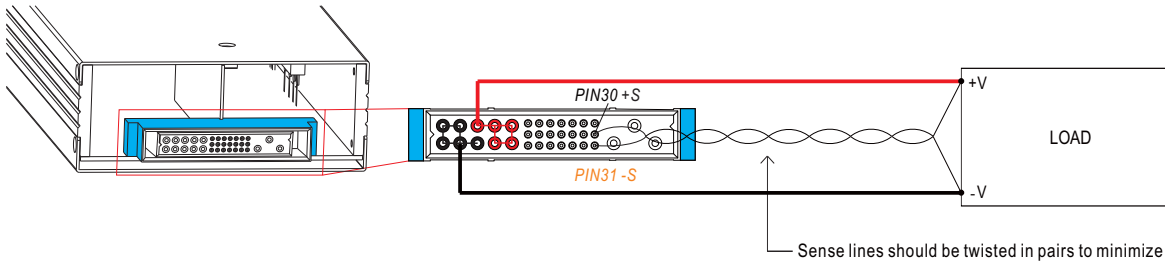

◎ The +S signal should be connected to the positive terminal of the load whereas -S signal to the negative terminal.

1.2 Local Sense

※ The +S,-S have to be connected to the +V(signal),-V(signal), respectively, as the following diagram, in order to get the correct output voltage if Remote Sense is not used.

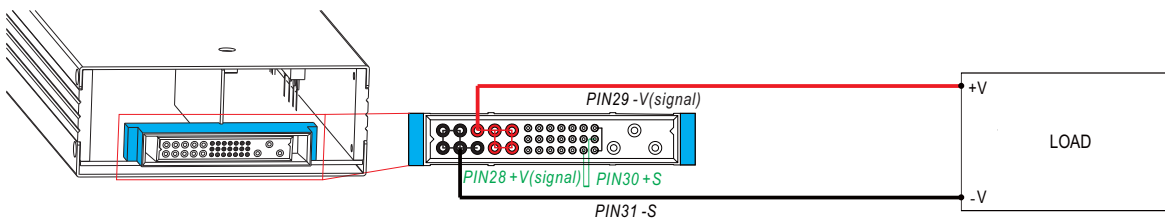

2. Output Voltage Programming (or, PV / remote voltage programming / remote adjust / margin programming / dynamic voltage trim)

※ In addition to the adjustment via the built-in potentiometer, the output voltage can be trimmed to 50~125% of the nominal voltage by applying EXTERNAL VOLTAGE.

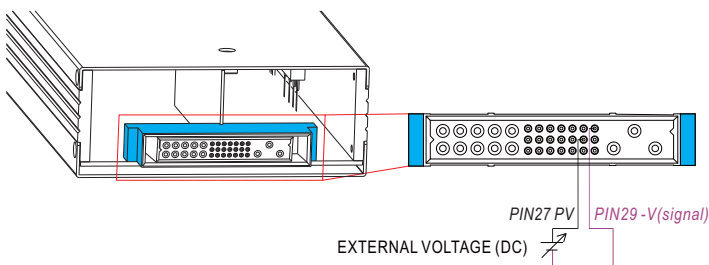

◎ For Remote Sense / Local Sense, please refer to "Voltage Drop Compensation" section.

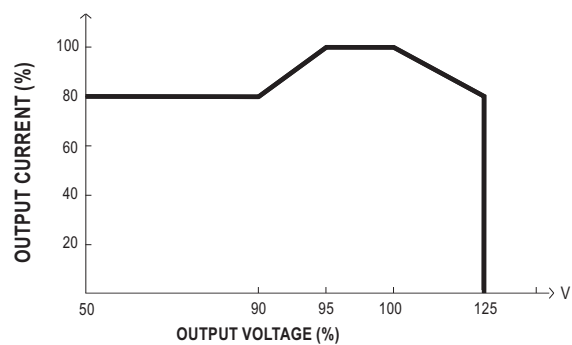
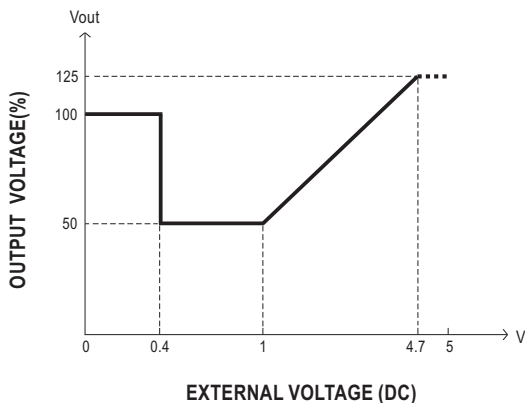

◎ The rated current should change with the Output Voltage Programming accordingly.

◎ For Remote Sense / Local Sense, please refer to "Voltage Drop Compensation" section.

3. Constant Current Level Programming (or, PC / remote current programming / dynamic current trim)

- ※ The constant current level can be trimmed to 20~100% of the rated current by applying EXTERNAL VOLTAGE.
- ※ If setting output current to a much lower level, as output status turns to constant current mode, it might cause higher current ripple under such condition.

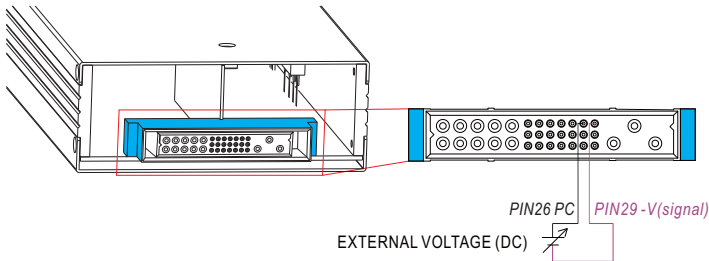

◎ For Remote Sense / Local Sense, please refer to "Voltage Drop Compensation" section.

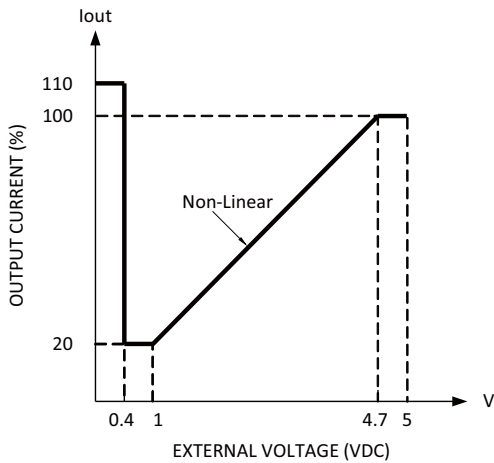

4. Remote ON-OFF Control

The power supply can be turned ON/OFF individually or along with other units by using the "Remote ON-OFF" function.

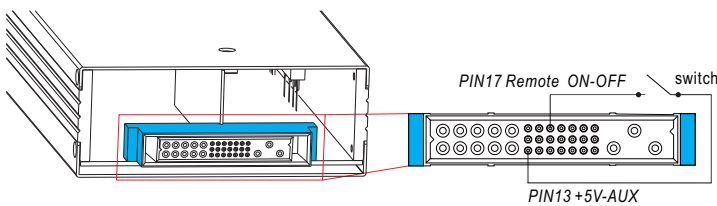

Between Remote ON-OFF and +5V-AUX	Power Supply Status
Switch Short	ON
Switch Open	OFF

5.PMBus Communication Interface

DRP-3200 supports PMBus Rev. 1.1 with maximum 100KHz bus speed, allowing information reading, status monitoring, output trimming, etc. For details, please refer to the Function Manual.

MECHANICAL SPECIFICATION

Case No.256 Unit:mm

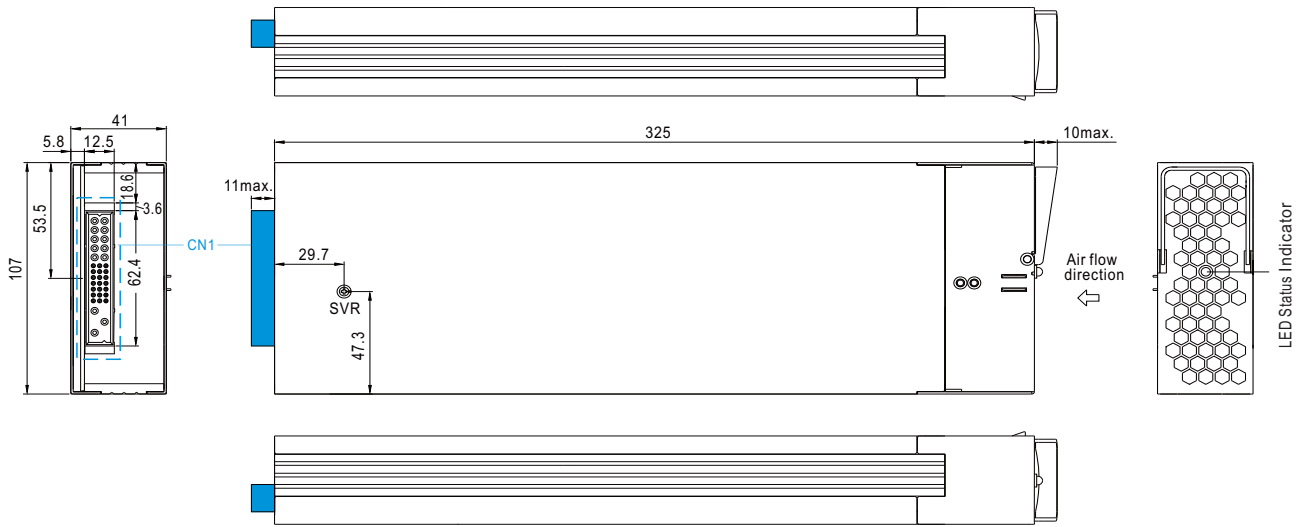

LED Status Indicators

LED	Description
● Green	The power supply functions normally.
● Red	The LED will present a constant red light when the abnormal status (OTP, OLP, fan fail and charging timeout) arises.
● Red (Flashing)	The LED will flash with the red light when the internal temperature reaches 60°C; under this condition, the unit still operates normally without entering OTP. (In the meantime, an alarm signal will be sent out through the PMBus interface.)

Input / Output Connector Pin No. Assignment(CN1) : Positronic PCIM34W13M400A1

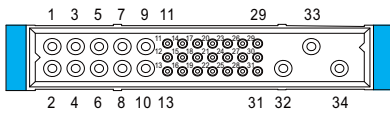

Mating Housing Positronic PCIM34W13F400A1

Pin No.	Function	Description
1,2,3,4,6	-V	Negative output terminal.
5,7,8,9,10	+V	Positive output terminal.
11	+12V-AUX	Auxiliary voltage output, 10.8~13.2V, referenced to GND-AUX (pin 12). The maximum load current is 0.8A. This output has the built-in "Oring diodes" and is not controlled by the Remote ON/OFF control.
12	GND-AUX	Auxiliary voltage output GND. The signal return is isolated from the output terminals (+V & -V).
13	+5V-AUX	Auxiliary voltage output, 4.5~5.5V, referenced to GND-AUX (pin 12). The maximum load current is 0.3A. This output has the built-in "Oring diodes" and is not controlled by the Remote ON/OFF control.
14	SCL	For PMBus model: Serial Clock used in the PMBus interface. (Note.2)
	CANL	For CANBus model: Data line used in CANBus interface. (Note.2)
15	SDA	For PMBus model: Serial Data used in the PMBus interface. (Note.2)
	CANH	For CANBus model: Data line used in CANBus interface. (Note.2)
16	T-ALARM	High (4.5 ~ 5.5V) : When the internal temperature exceeds the limit of temperature alarm, or when fan fails. Low (0 ~ 0.5V) : When the internal temperature is normal, and when fan works normally. The maximum sourcing current is 10mA and only for output.(Note.2)
17	Remote ON-OFF	The unit can turn the output ON/OFF by electrical signal or dry contact between Remote ON/OFF and +5V-AUX. (Note.2) Short (4.5 ~ 5.5V) : Power ON ; Open (-0.5 ~ 0.5V) : Power OFF ; The maximum input voltage is 5.5V.
18	DC-OK	High (4.5 ~ 5.5V) : When the Vout ≤ 80%±5%. Low (-0.5 ~ 0.5V) : When Vout ≥ 80%±5%. The maximum sourcing current is 10mA and only for output. (Note.2)
19	AC-OK	High (4.5 ~ 5.5V) : When the input voltage is ≥ 87Vrms . Low (-0.5 ~ 0.5V) : When the input voltage is ≤ 75Vrms. The maximum sourcing current is 10mA and only for output. (Note.2)
20,21,22,23	A3,A2,A1,A0	PMBus interface address lines. (Note.1)
24,25	DB,DA	Differential digital signal for parallel control. (Note.1)
26	PC	Connection for constant current level programming. (Note.1)
27	PV	Connection for output voltage programming. (Note.1)
28	+V (Signal)	Positive output voltage signal. It is for local sense; it cannot be connected directly to the load.
29	-V (Signal)	Negative output voltage signal. It is for local sense; and certain function reference; it cannot be connected directly to the load.
30	+S	Positive sensing for remote sense.
31	-S	Negative sensing for remote sense.
32	FG	AC Ground connection.
33	AC/L	AC Line connection.
34	AC/N	AC Neutral connection.

Note1: Non-isolated signal, referenced to [-V(signal)].
Note2: Isolated signal, referenced to GND-AUX.