

UNO-3272

**Celeron M Embedded
Automation Computer with
Two PCI-Slot Extensions**

User Manual

Copyright

This document is copyrighted, © 2009. All rights are reserved. The original manufacturer reserves the right to make improvements to the products described in this manual at any time without notice.

No part of this manual may be reproduced, copied, translated or transmitted in any form or by any means without the prior written permission of the original manufacturer. Information provided in this manual is intended to be accurate and reliable. However, the original manufacturer assumes no responsibility for its use, nor for any infringements upon the rights of third parties that may result from such use.

Acknowledgements

Intel[®], Pentium[®] and Celeron[®] are registered trademarks of Intel Corporation. Microsoft[®] Windows and MS-DOS are registered trademarks of Microsoft[®] Corp. All other product names or trademarks are properties of their respective owners.

Support

For more information on this and other Advantech products, please visit our websites at: <http://www.advantech.com>

For technical support and service, please visit our support website at:
<http://www.advantech.com/support/>

Part No. 2003327200 1st Edition

Printed in Taiwan December 2009

Product Warranty (2 years)

Advantech warrants to you, the original purchaser, that each of its products will be free from defects in materials and workmanship for two years from the date of purchase.

This warranty does not apply to any products that have been repaired or altered by persons other than repair personnel authorized by Advantech, or which have been subject to misuse, abuse, accident or improper installation. Advantech assumes no liability under the terms of this warranty as a consequence of such events.

Because of Advantech high quality-control standards and rigorous testing, most of our customers never need to use our repair service. If an Advantech product is defective, it will be repaired or replaced at no charge during the warranty period. For out-of-warranty repairs, you will be billed according to the cost of replacement materials, service time and freight. Please consult your dealer for more details. If you think you have a defective product, follow these steps:

Step 1: Collect all the information about the problem encountered. (For example, CPU speed, Advantech products used, other hardware and software used, etc.) Note anything abnormal and list any on- screen messages you get when the problem occurs.

Step 2: Call your dealer and describe the problem. Please have your manual, product, and any helpful information readily available.

Step 3: If your product is diagnosed as defective, obtain an RMA (return merchandise authorization) number from your dealer. This allows us to process your return more quickly.

Step 4: Carefully pack the defective product, a fully completed Repair and Replacement Order Card and a photocopy proof of purchase date (such as your sales receipt) in a shippable container. A product returned without proof of the purchase date is not eligible for warranty service.

Step 5: Write the RMA number visibly on the outside of the package and ship it prepaid to your dealer.

CE

This product has passed the CE test for environmental specifications. Test conditions for passing included the equipment being operated within an industrial enclosure. In order to protect the product from being damaged by ESD (Electrostatic Discharge) and EMI leakage, we strongly recommend the use of CE-compliant industrial enclosure products.

FCC Class A

This equipment has been tested and found to comply with the limits for a Class A digital device, pursuant to Part 15 of the FCC Rules. These limits are designed to provide reasonable protection against harmful interference when the equipment is operated in a commercial environment. This equipment can generate, use and radiate radio frequency energy and, if not installed and used in accordance with the instruction manual, may cause harmful interference to radio communications. Operation of this equipment in a residential area is likely to cause harmful interference in which case the user will be required to correct the interference at his own expense.

CAUTION

The computer is provided with a battery-powered real-time clock circuit. There is a danger of explosion if battery is incorrectly replaced. Replace only with same or equivalent type recommended by the manufacture.

UL - RESTRICTED AREA ACCESS

The equipment should only be installed in a Restricted Access Area.

This product has passed the UL test for environmental specifications. Test conditions for passing included the equipment being operated within an industrial enclosure.

Technical Support and Assistance

Step 1: Visit the Advantech web site at www.advantech.com/support where you can find the latest information about the product.

Step 2: Contact your distributor, sales representative, or Advantech's customer service center for technical support if you need additional assistance.

Contents

Chapter 1	Overview	2
1.1	Introduction	2
1.2	Hardware Specifications	4
1.2.1	Interface:	4
1.3	Safety Precautions	6
1.4	Chassis Dimensions.....	7
	Figure 1.1:Chassis Dimensions	7
1.5	Packing List.....	8
	Figure 1.2: Accessories	8
Chapter 2	Hardware Functionality	10
2.1	Introduction	10
	Figure 2.1:Front Panel of UNO-3272	10
	Figure 2.2:Rear Panel of UNO-3272	10
2.2	RS-232 Interface (COM1~COM2)	11
2.3	RS-232/422/485 Interface (COM3~COM4)	11
2.3.1	IRQ and Address Setting	14
2.3.2	Switch Setting for SRAM and Display Port.	15
2.3.3	PCIe Configuration	16
2.4	LAN: Ethernet Connector	17
2.5	Power Input	17
	Figure 2.3:Location of Power Input	17
2.6	USB Connector	18
2.7	VGA Display Connector	18
2.8	Battery Backup SRAM	18
	Figure 2.4:LED Location for Battery Backup	18
2.8.1	Lithium Battery Specification	19
	Figure 2.5:Lithium Battery for SRAM	19
2.9	Reset Button	19
Chapter 3	Initial Setup.....	22
3.1	Inserting a CompactFlash Card	22
3.2	Connecting Power	22
3.3	Installing a Hard Disk	23
3.4	Installing a PCI-bus Card	26
3.5	BIOS Setup and System Assignments	27
Appendix A	System Settings and Pin Assignments	30
A.1	System I/O Address and Interrupt Assignments	30
A.2	Board Connectors and Jumpers.....	32
	Figure A.1:Mainboard Connector & Jumpers	32
	Table A.3:Connector and Jumper Descriptions	33
A.3	RS-232 Standard Serial Port (COM1~COM2)	34
	Table A.4:RS-232 Serial Port Pin Assigns	34
A.4	RS-232/422/485 Serial Port (COM3~COM4)	35
	Table A.5:RS-232/422/485 Serial Port Pin Assigns	35

A.5	Ethernet RJ-45 Connector (LAN1~LAN2).....	35
	Table A.6:Ethernet RJ-45 Connector Pin Assigns	35
A.6	Power Screw Terminal	36
	Table A.7: Phoenix Power Connector Pin Assigns	36
A.7	PS/2 Keyboard and Mouse Connector	36
	Table A.8:Keyboard & Mouse Connector Pins	36
A.8	USB Connector (USB1~USB4).....	37
	Table A.9:USB Connector Pin Assignments	37
A.9	VGA Display Connector	37
	Table A.10:VGA Adaptor Cable Pin Assignmen	37
A.11	PCI-express Connector (Optional).....	39
Appendix B	Programming the Watchdog Timer	42

Overview

This chapter provides an overview of UNO-3272 specifications.

Sections include:

- Introduction
- Hardware specification
- Safety precautions
- Chassis dimensions

Chapter 1 Overview

1.1 Introduction

Standard PCs and some industrial computers with a standard OS and hardware for the consumer market cannot provide the reliability required by industrial automation and embedded industrial control applications. However, many engineers prefer to use PCs because of their advanced functions such as: analog control and simulation, database connectivity, web-based applications, and communication with third-party devices. UNO-3272 combines the best features of a PC, including the processor, RAM, and powerful software, with the reliability, ruggedness, and distributed nature of a PLC. UNO-3272 has the compact size and ruggedness of a PLC, and the software flexibility and functionality of a PC. It's an ideal platform for sophisticated control and logging in rugged environments.

Open Architecture Designed for Automation

For applications demanding customized control, UNO-3272 that uses more flexible, off-the-shelf technology is a better option. UNO-3272 uses off-the-shelf components such as an x86 processor, an Ethernet chip set, CompactFlash and DRAM. System designers can easily create multiple inputs from sensors via plug-in data acquisition cards and provide outputs to other devices to control the operation. At the same time, the UNO-3272 unit can broadcast the process data through the Ethernet and share the data with operators and managers. By using off-the-shelf components, machine builders can customize the control scheme they use for other machines that require multiple inputs, optimized control, or Ethernet communication. UNO-3272 offers the I/O connectivity of PCs with options such as 2 x 10/100/1000Base-T Ethernet, 2 x RS-232, 2 x RS-232/422/485, 5 x USB, CompactFlash, PCI extension slots and VGA/ DVI-D interfaces for display panels.

An Industry-Proven Design

Industrial and mobile applications require controllers with high-vibration resistance and a wide temperature range. Machines or controllers in light industrial environments also require flexible and stable mounting. Many machine builders underestimate the need for rugged controllers because their end applications are mounted in an industrial enclosure. Advantech UNO-3272 has a special design without the weaknesses of a standard PC. No fan and no HDD design prevent dust and vibration problems. A battery-backup function secures the last state of the system, making system crashes less problematic. With a smart mechanical design, UNO-3272 can meet 50G shock, 2G vibration, and up to 60° operating temperature and almost everything a harsh industrial environment demands.

Off-the-shelf Universal PCI Extensions

From a computing point of view, the UNO-3272 with its PC-based control CPU is a high-end machine controller. It can be simply operated with the onboard Ethernet interface or with a PC Fieldbus card. Two free PCI slots are also available. In addition, Advantech offers a complete product line for plug-in data acquisition and control I/O, motion control, GPIB, industrial communication and Fieldbus communication cards.

Designed to Fit Into Control Cabinets

The fully-fledged UNO-3272 could easily be mistaken for a PLC by its look and feel. In completely new packaging, the smallest UNO only measures 200 mm x 240 mm x 130 mm (W x H x D). But the UNO-3272 not only deals with PLC tasks, but also offers all the operating and communication power of a modern PC with Intel Celeron M processor and Windows Operating System software. So, Advantech UNO-3272 is a small, powerful and inexpensive PLC substitute.

Flexible Networking Options

UNO-3272 offers three ways to connect to a network: Ethernet, Wireless LAN and Modem. The two built-in Ethernet ports provide high-speed networking capability up to 1000 Mbps. The PCI slot extension with wireless LAN module offers you a mobile and scalable network without incurring additional cabling costs. And through COM ports of UNO-3272, industrial modems offer the most popular and easiest networking method by PSTN.

Popular Operating Systems and Rapid Application Development

UNO-3272 supports the popular off-the-shelf Microsoft Windows 2000/XP/Vista operating systems and the Linux operating system. UNO-3272 also features pre-built Microsoft Windows XP embedded solutions offering a pre-configured image with optimized onboard device drivers. Windows XP Embedded are compact, highly efficient, and real-time operating systems that are designed for embedded systems without a HDD. they have all been done for the Advantech UNO-3272 series. the UNO-3272 series leverages your existing Windows-based programming skills to rapidly develop applications.

1.2 Hardware Specifications

- **CPU:** Celeron M CPU, 440 1.8GHz or above
- **System Memory:** 1GB DDRII RAM on board
- **Battery Backup RAM:** 512 KB
- **Chipset:** Intel 945GM GMCH/ICH7-M Chipset 667 MHz FSB
- **BIOS:** Award 4 Mbit Flash BIOS, supports Boot-on-LAN function

1.2.1 Interface:

- **Display:** VGA& DVI-D, supports dual display
- **Keyboard/Mouse:** PS/2 keyboard & mouse
- **Serial Ports:** 2 x RS-232 and 2 x RS-232/422/485 with DB-9 connector and Automatic RS-485 data flow control
- **Serial Speed:** RS-232 Speed: 50 bps ~ 115.2 kbps, RS-422/485 Speed: 50 bps ~ 921.6 kbps
- **LAN:** Two 10/100/1000 Base-T RJ-45 ports
- **USB Interface:** Five USB ports, USB UHCI, Rev. 2.0 compliant
- **Audio:** Line in, Line out
- **CompactFlash Slots:** One internal and one external
- **LED:** PWR, STB, HDD, BTR - Power, Standby, HDD, SRAM Battery
PL1, PL2, PL3, PL4 -User Defined LED's 1~4
Tx1, Rx1, Tx2, Rx2 - COM1/ COM2
Tx3, Rx3, Tx4, Rx4 - COM3/ COM4
LINK, ACT(LAN1), LINK, ACT(LAN2) - LAN1/ LAN2

- **Two PCI-bus Slots support:** 12 V @ 5 A
 -12 V @ 0.8 A
 5 V @ 8 A
 3.3 V @ 6 A
- **SSD:** One internal Type I / Type II CompactFlash card slot
- **HDD:** HDD extension kit for installing two standard 2.5" SATA HDD's
- **Anti-Shock:**
 20 G @ Wall mounting, IEC 68 section 2-27, half sine, 11 ms w/HDD
 50 G @ Wall mounting, IEC 68 section 2-27, half sine, 11 ms w/CF
- **Anti-Vibration:**
 2 Grms w/CF@IEC 68 sec. 2-64, random, 5~500Hz, 1 Oct./min, 1hr axis
 1 Grms w/HDD@IEC 68 sec. 2-64, random, 5~500Hz, 1 Oct./min, 1hr axis
- **Power Supply:** 9 ~ 36 VDC (e.g +24 V @ 5 A), ATX
- **Operating Temperature:** -20 ~ 60° C(-4 ~ 140° F), with Industrial CF

Note: The temperature inside the chassis may be 5° to 10° higher than the ambient temperature. To ensure stable performance, please make sure the operating temperature of the installed PCI add-on card is equal to or higher than 60° C.

- **Relative Humidity:** 0~95% @ 40° C (non-condensing)
- **Power Consumption:** 100 W (Typical)
- **Power Requirement:** Min 96 W, (9~36 VDC) (e.g. +24 V @ 4A)
- **Chassis Size (WxHxD):** 200 mm x 240 mm x 130 mm (7.9" x 9.4" x 5")
- **Mounting:** Wall/Stand mounting
- **Weight:** 6.0 kg
- **Software OS:** Windows XP Embedded, Windows 2000/XP/ Vista, Linux

1.3 Safety Precautions

The following messages inform how to make each connection. In most cases, you will simply need to connect a standard cable.

Note: Always disconnect the power cord from your chassis whenever you are working on it. Do not connect while the power is on. A sudden rush of power can damage sensitive electronic components. Only experienced electronics personnel should open the chassis.

Note: Always ground yourself to remove any static electric charge before touching UNO-3272. Modern electronic devices are very sensitive to static electric charges. Use a grounding wrist strap at all times. Place all electronic components on a static-dissipative surface or in a static-shielded bag.

Note: If DC voltage is supplied by an external circuit, please put a protection device in the power supply input port.

1.4 Chassis Dimensions

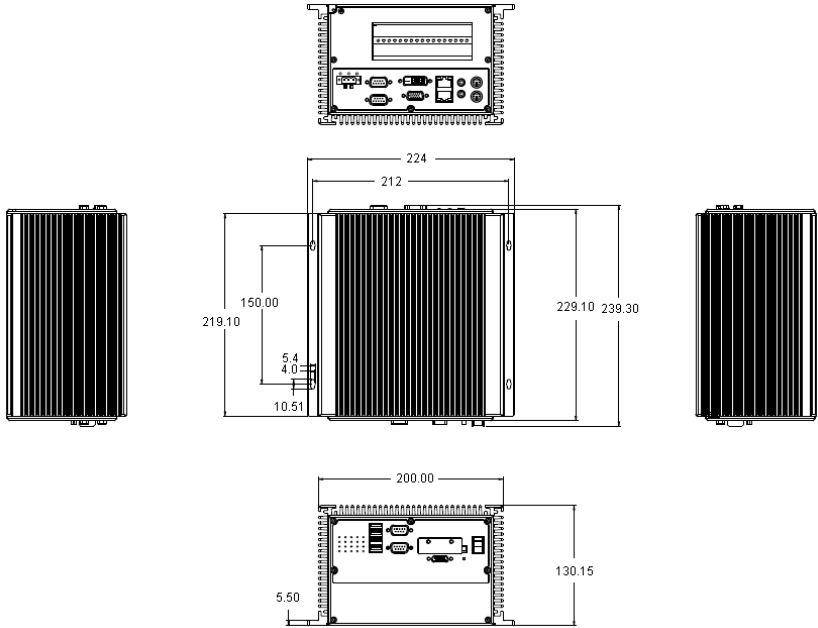

Figure 1.1: Chassis Dimensions

1.5 Packing List

The accessory package of UNO-3272 contains the following items:

- (A) SATA HDD cable
- (B) Warranty card
- (C) Driver and Utility CD-ROM
- (D) Anti-vibration rubber
- (E) Power connector
- (F) HDD fixing screw



Figure 1.2: Accessories

Hardware Functionality

This chapter shows how to setup the UNO-3272 hardware functions, including connecting peripherals, and setting switches and indicators.

Sections include:

- Introduction
- RS-232 Interface
- RS-232/422/485 Interface
- LAN / Ethernet Connector
- Power Connector
- USB Connector
- VGA Display Connector
- Battery Backup SRAM
- Reset Button

Chapter 2 Hardware Functionality

2.1 Introduction

The two figures below show the connectors on UNO-3272, and following sections give you detailed information about function of each peripheral.

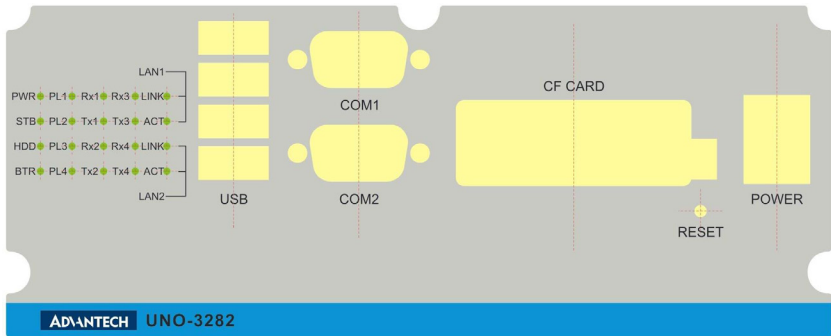

Figure 2.1: Front Panel of UNO-3272

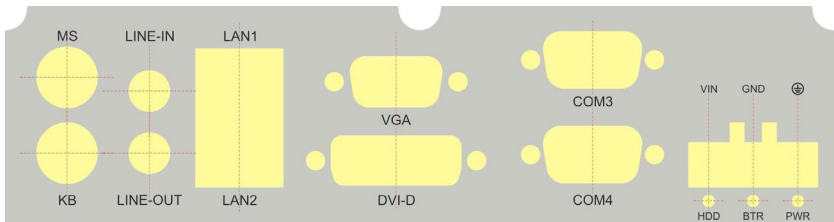

Figure 2.2: Rear Panel of UNO-3272

2.2 RS-232 Interface (COM1~COM2)

The UNO-3272 offers two industrial standard RS-232 serial communication interface ports: COM1 and COM2.

The IRQ and I/O address range of COM1 and COM2 are listed below:
COM1: 3F8H, IRQ4
COM2: 2F8H, IRQ3

2.3 RS-232/422/485 Interface (COM3~COM4)

1. Termination Resistor (SW9)

The onboard termination resistor (120 ohm) for COM3/COM4 can be used for long distance transmission or device matching (Default Off).

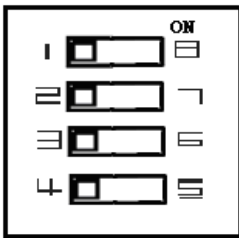

SW9

Pin	Description
1-8	TX+/TX- for COM3 Data+/Data- for COM3
2-7	RX+/RX- for COM3
3-6	TX+/TX- for COM4 Data+/Data- for COM4
4-5	RX+/RX- for COM4

RS-232/422/485 Selection

COM3 and COM4 support 9-wire RS-232, RS-422 and RS-485 interfaces. The system detects RS-422 or RS-485 signals automatically in RS-422/485 mode.

To select between RS-422/485 and RS-232 for COM3, adjust CN25.

To select between RS-422/485 and RS-232 for COM4, adjust CN26.

Jumper setting for RS-232 interface: (Default setting). (CN25/CN26)

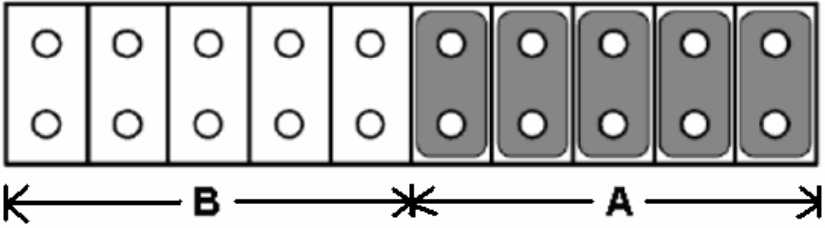

Jumper setting for RS-422/485 interface: (Default setting). (CN25/CN26)

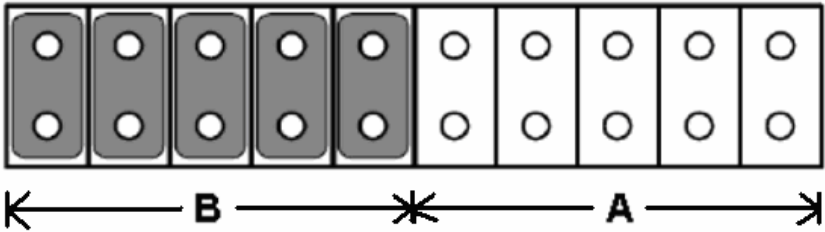

RS-485 Auto Flow & RS-422 Master/Slave Mode

You can set the “Auto Flow Control” mode of RS-485 or “Master/Slave” mode of RS-422 by using the SW5 DIP switch for each RS-422/485 port.

In RS-485, if the switch is set to “Auto”, the driver automatically senses the direction of the data flow and switches the direction of transmission.

No handshaking is necessary.

In RS-422, if DIP switch is set to “On,” the driver is always enabled, and always in high or low status.

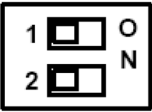
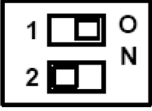
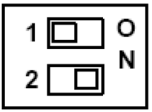
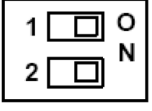
 <p>(Default)</p>	COM3	RS-422: Slave mode
		RS-485: Auto flow control
	COM4	RS-422: Slave mode
		RS-485: Auto flow control
	COM3	RS-422: Master mode
		RS-485: N/A
	COM4	RS-422: Slave mode
		RS-485: Auto flow control
	COM3	RS-422: Slave mode
		RS-485: Auto flow control
	COM4	RS-422: Master mode
		RS-485: N/A
	COM3	RS-422: Master mode
		RS-485: N/A
	COM4	RS-422: Master mode
		RS-485: N/A

2.3.1 IRQ and Address Setting

The IRQ and I/O address range of COM3 and COM4 are listed below:

- COM3: 3E8H, IRQ10 (Independent IRQ), IRQ10 (Share IRQ)
- COM4: 2E8H, IRQ5 (Independent IRQ), IRQ10 (Share IRQ)
- Vector address for share IRQ: 1D0H

You can set “Share IRQ” or “Independent IRQ” by the first switch of SW4.

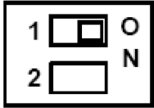
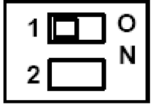
	Share IRQ (default)
	Independent IRQ

You can adjust the transmission rate by the second switch of SW4

* To increase the normal baud rates by eight times, (e.g. if 115.2K bps is set, the baud rate will be increased to 921.6K bps), set switch 2 of SW4 to “on”.

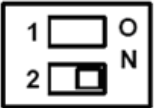
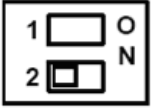
	Speed x 8*
	Speed x 1 (default)

2.3.2 Switch Setting for SRAM and Display Port.

You could set up SRAM enable or disable by the first switch of SW8.

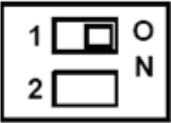
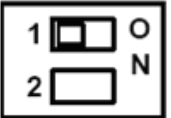
	Disable SRAM function
	Enable SRAM function(Default)

You could set up plug and play setting of display port by the second switch of SW8.

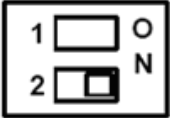
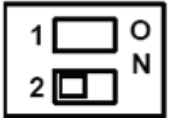
	Support VGA Plug and Play function in DOS mode
	Support DVI Plug and Play function

2.3.3 PCIe Configuration

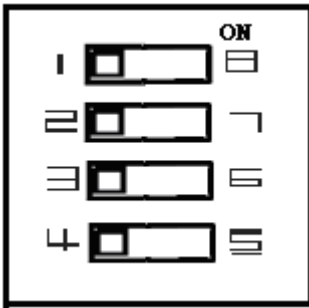

SW3

Pin	Description
1-8	SEL0_B
2-7	SEL1_B
3-6	SEL2_B
4-5	SEL3_B

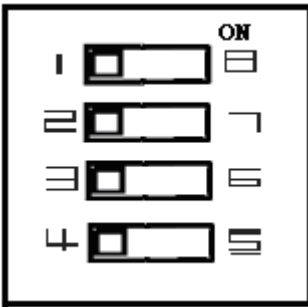

SW7

Pin	Description
1-8	SEL0_A
2-7	SEL1_A
3-6	SEL2_A
4-5	SEL3_A

Selection pins description for Equalizer, amplifier, and De-emphasis respectively.

SEL0_[A:B]	SEL1_[A:B]	Compliance Channel
0	0	no equalization
0	1	[0:2.5dB] @ 1.25 GHz
1	0	[2.5:4.5dB] @ 1.25 GHz
1	1	[4.5:6.5dB] @ 1.25 GHz

Output Swing Control

SEL2_[A:B]	Swing
0	1x
1	1.2x

Output De-emphasis Adjustment

SEL3_[A:B]	De-emphasis
0	0dB
1	-3.5dB

2.4 LAN: Ethernet Connector

The UNO-3272 is equipped with a Intel 82573L Ethernet LAN controller that is fully compliant with IEEE 802.3u 10/100/ 1000 Base-T CSMA/CD standards. The Ethernet port provides a standard RJ-45 jack on board, and LED indicators on the front side to show its Link (Green LED) and Active (10/100 MB at Orange LED, 1000 MB at Green LED) status.

2.5 Power Input

UNO-3272 comes with a Phoenix connector that carries 9~36 VDC external power input, and features reversed wiring protection. Therefore, it will not cause any damage to the system by reversed wiring of ground line and power line. (Please refer to Fig 2.3 for location of power input).

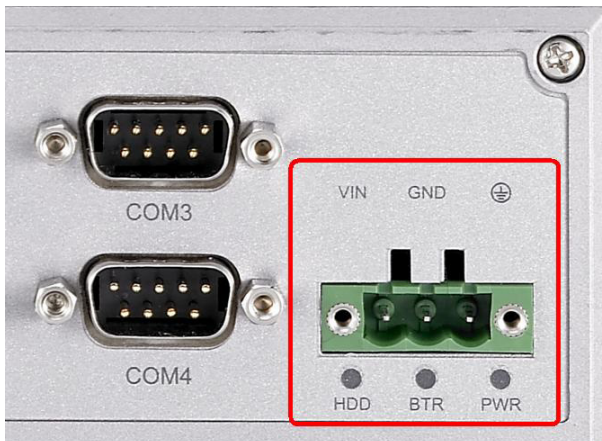

Figure 2.3: Location of Power Input

2.6 USB Connector

The USB connector is used for connecting any device that conforms to the USB interface. Many recent digital devices conform to this standard. The USB interface supports Plug and Play, which enables you to connect or disconnect a device whenever you want, without turning off the computer.

The UNO-3272 provides five connectors of USB interfaces(4x external, 1x internal). The USB interface complies with USB UHCI, Rev. 2.0 compliant. The USB inter-face can be disabled in the system BIOS setup. Please refer to Appendix A.8 for its pin assignments.

2.7 VGA Display Connector

The UNO-3272 provides a VGA controller (Intel 945GM integrated 2D/ 3D graphic controller) for a high resolution VGA interface. It supports CRT mode to 1600x 1200,frame buffer max memory allocation support base on total system memory, UNO-3272 provides VGA + DVI-D connector and support dual display output

2.8 Battery Backup SRAM

UNO-3272 provides 512 KB of battery backup SRAM. This ensures that you have a safe place to store critical data. You can now write software applications without being concerned that system crashes will erase critical data from the memory. There is a BTR LED in the front panel of the UNO-3272 (Figure 2.4). Please replace the lithium battery if the BTR LED is activated.

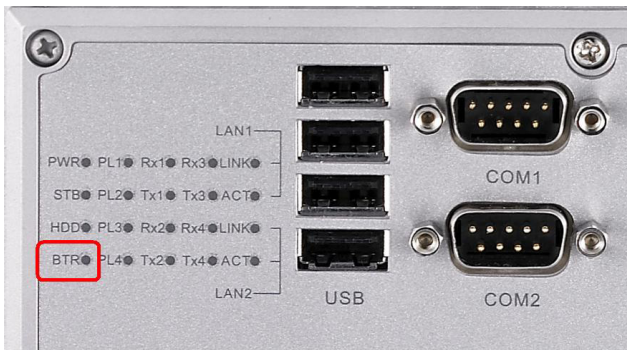

Figure 2.4: LED Location for Battery Backup

2.8.1 Lithium Battery Specification

Type: BR2032 (Using CR2032 is NOT recommended)

Output voltage: 3 VDC

Location: Mainboard of UNO-3272. (Figure 2.5)

When the voltage of the battery < 2.5 VDC, the BTR LED will light up.

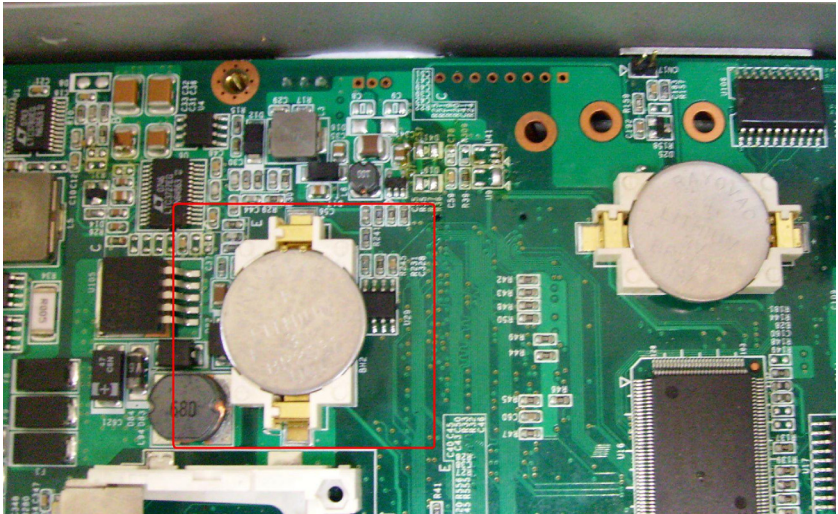
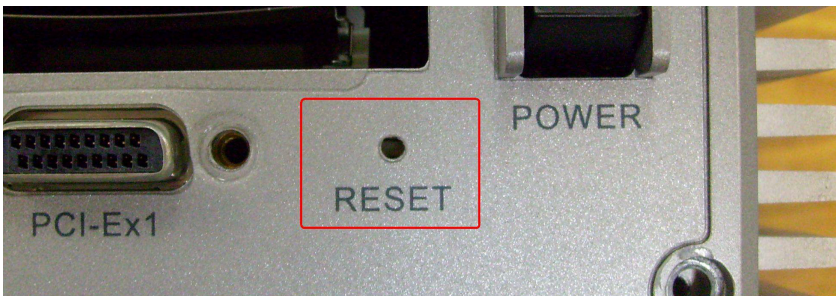

Figure 2.5: Lithium Battery for SRAM

2.9 Reset Button

Press the "Reset" button to activate the reset function.



Initial Setup

This chapter introduces how to initialize the UNO-3272.

Sections include:

- Inserting a CompactFlash Card
- Connecting Power
- Connecting a Hard Disk
- BIOS Setup and System Assignments

Chapter 3 Initial Setup

3.1 Inserting a CompactFlash Card

UNO-3272 provides two CompactFlash slots. One slot (CN6) is accessible from the front panel, where you can insert your CompactFlash card directly. The other slot (CN7) is inside UNO-3272 on its motherboard.

*Note: Internal & external CompactFlash doesn't support Hot Swap
Need to use "Fixed Disk Mode" CompactFlash to install OS*

Following is the procedure for the installing a CompactFlash card in the internal slot (CN7) of your UNO-3272.

Please follow these steps carefully:

1. Remove the power cord.
2. Unscrew the screws from the bottom cover of UNO-3272.
3. Remove the bottom cover.
4. Plug a CompactFlash card with your OS and application program into a CompactFlash card slot on mainboard.
5. Screw back the bottom cover with screws.

3.2 Connecting Power

Connect the UNO-3272 to a 9 ~ 36 VDC power source. The power source can either be from a power adapter or an in-house power source.

3.3 Installing a Hard Disk

The procedure for installing a hard disk into the UNO-3272 is listed below. Please follow these steps carefully.

1. Remove the power cord.
2. Unscrew the six screws from the bottom cover (as shown below)



3. Move one screw to the center and it will make easy to remove the bottom cover.



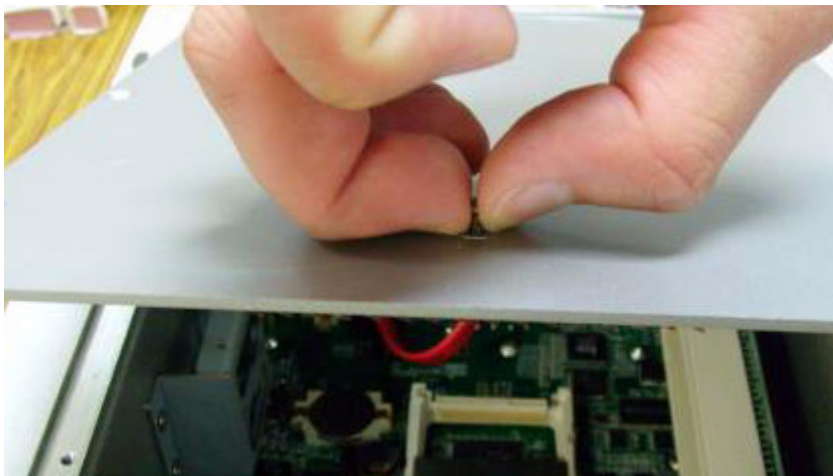

4. Install the HDD in HDD bracket and secure with the four screws, and then fix the HDD bracket on the bottom cover



5. Connect the SATA power cable with SATA connector(CN15 or CN22)

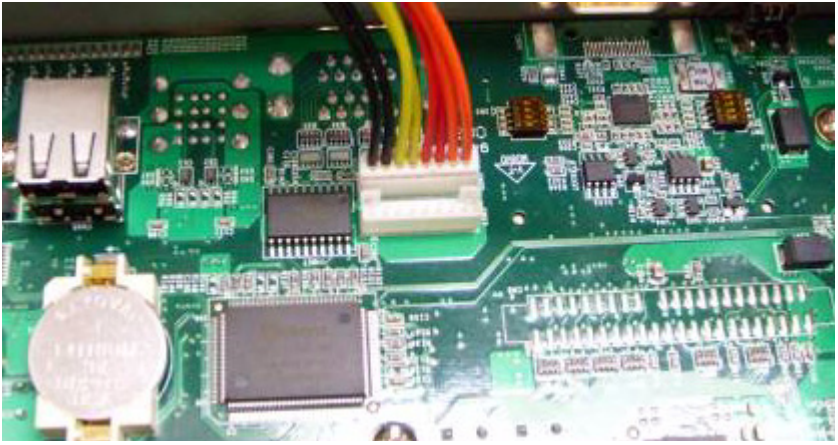

6. Connect the SATA cable with SATA connector (CN16 or CN18)

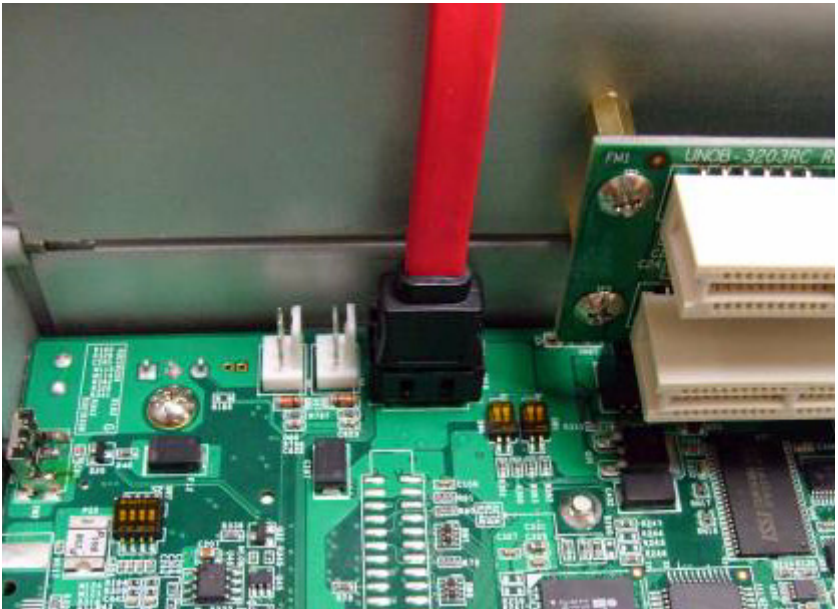

7. Refasten the bottom cover with the six screws.

3.4 Installing a PCI-bus Card

The procedure for installing a PCI-bus card into the UNO-3272 is listed below. Please follow these steps carefully.

1. Remove the power cord.
2. Remove the bottom cover of UNO-3272.
3. Unscrew the screw of a PCI bracket, and remove it.



4. Plug-in PCI-bus card in a PCI-slot of UNO-3272.
5. Cut off a part of the anti-vibration rubber if it is too long to fit into the box when the PCI card is fixed.



6. Screw the 1st anti-vibration rubber towards the 1st PCI card until it is fixed.



7. Screw back the bottom cover with the six screws.

3.5 BIOS Setup and System Assignments

UNO-3272 adapts Advantech's SOM-5782 CPU module. Further information about the SOM-5782 CPU module can be found in user manual of SOM-5782. You can find this manual on the driver and utility CD of UNO-3272 in the accessory package. Please note that you can try to "LOAD BIOS DEFAULTS" from the BIOS Setup manual if the UNO-3272 does not work properly.

APPENDIX
A

**System Settings and
Pin Assignments**

Appendix A System Settings and Pin Assignments

A.1 System I/O Address and Interrupt Assignments

Table A.1: UNO-3272 System I/O Ports

Address Range	Device
000-00F	DMA controller
020-03F	Interrupt controller 1, (master)
040-05F	Timer/counter
060-06F	(keyboard controller)
070-07F	Real-time clock, non-maskable interrupt (NMI)
	Mask
080-09F	DMA page register
0A0-0BF	Interrupt controller 2 (slave)
0C0-0DF	DMA controller
0F0	Clear math co-processor
0F1	Reset math co-processor
0F8-0FF	Math co-processor
1F0-1F7	Primary IDE channel
200-207	Game I/O
274-279	ISAPNP Read Data Port
2E8-2EF	Serial port 4
2F8-2FF	Serial port 2
3B0-3DF	Intel 915GM Express Chipset Family
3E8-3EF	Serial port 3
3F8-3FF	Serial port 1
500-51E	Intel 82801 SMBus Controller– 266A
DC000-DFFFF	Battery back-up RAM
E000-E01F	Intel 82801 USB Host Controller - 2658
E100-E11F	Intel 82801 USB Host Controller - 2659
E200-E21F	Intel 82801 USB Host Controller - 265A
E300-E31F	Intel 82801 USB Host Controller - 265B
1D0	Vector address; for COM port share IRQ
1E0	Battery backup resource
11E	Battery backup resource

Table A.2: UNO-3272 Interrupt Assignment

Interrupt No.	Interrupt Source
NMI	Parity error detected
IRQ 0	Interval timer
IRQ 1	Keyboard
IRQ 2	Interrupt from controller 2 (cascade)
IRQ 3	COM2
IRQ 4	COM1
IRQ 5	COM4 (Independent IRQ)
IRQ 6	Diskette controller (FDC)
IRQ 7	PCMCIA
IRQ 8	Real-time clock
IRQ 10	COM3 (Independent IRQ)/COM3&COM4 Share IRQ
IRQ 11	Reserved for watchdog timer
IRQ 12	PS/2 mouse
IRQ 13	INT from co-processor
IRQ 14	Primary IDE
IRQ 15	Secondary IDE

Note: USB and Ethernet IRQ is set automatically by system

A.2 Board Connectors and Jumpers

There are several connectors and jumpers on the UNO-3272 board. The following sections tell you how to configure the UNO-3272 hardware setting. Figure A.1 shows the location of the connectors and jumpers.

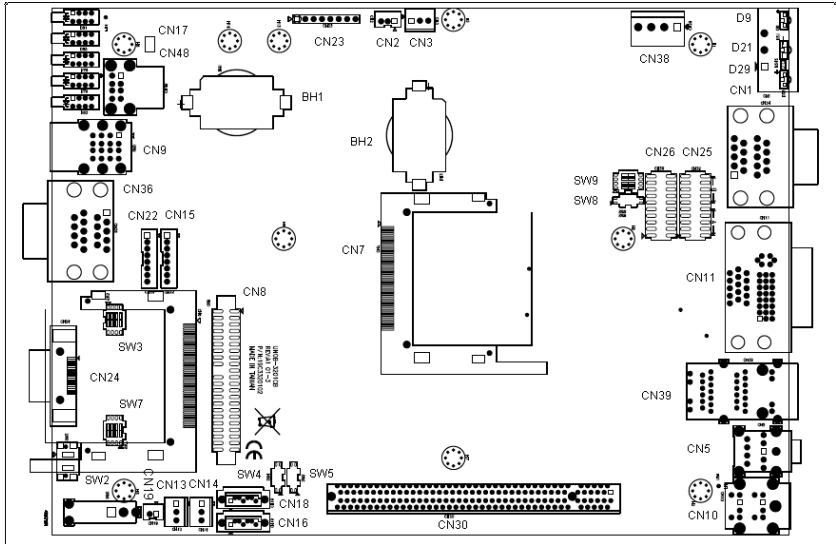

Figure A.1: Mainboard Connector & Jumpers

Table A.3: Connector and Jumper Descriptions

Mainboard	BH1	Battery for RTC
	BH2	Battery for SRAM
	CN1	Phoenix power connector
	CN5	Audio's Line-in/Line-out
	CN9	USB connector
	CN10	PS/2 keyboard and mouse connector
	CN11	DVI+DSUB connector
	CN13	SYS FAN
	CN14	SYS FAN
	CN15	Internal SATA power connector
	CN16	Internal SATA signal connector
	CN17	clear CMOS
	CN18	Internal SATA signal connector
	CN22	Internal SATA power connector
	CN24	PCIExpress connector(option)
	CN25	COM3 RS-232/422/485 selection
	CN26	COM4 RS-232/422/485 selection
	CN30	PCIExpress *16 slot
	CN36	COM1/COM2 RS-232 serial port
	CN38	DC power input
	CN39	Ethernet port 1 & 2
	CN48	USB connector
	SW2	Reset button
	SW3	PCIExpress Configuration switch
	SW4	Share IRQ/Independent IRQ, Speed selection switch
	SW5	COM3/COM4 RS-422 master/slave selection
	SW7	PCIExpress Configuration switch
	SW8	Enable/disable battery back RAM, DOS VGA/DVI plug-and-play mode selection switch
	SW9	Terminator resistor (120 ohm) for COM3/COM4 (RS-422/RS-485)

A.3 RS-232 Standard Serial Port (COM1~COM2)

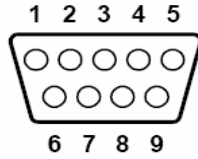

Table A.4: RS-232 Serial Port Pin Assigns

Pin	RS-232 Signal Name
1	DCD
2	RxD
3	TxD
4	DTR
5	GND
6	DSR
7	RTS
8	CTS
9	RI

A.4 RS-232/422/485 Serial Port (COM3~COM4)

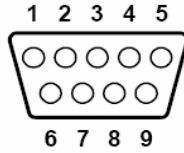

Table A.5: RS-232/422/485 Serial Port Pin Assigns

Pin	RS-232	RS-422	RS-485
1	DCD	Tx-	DATA-
2	RxD	Tx+	DATA+
3	TxD	Rx+	NC
4	DTR	Rx-	NC
5	GND	GND	GND
6	DSR	NC	NC
7	RTS	NC	NC
8	CTS	NC	NC
9	RI	NC	NC

A.5 Ethernet RJ-45 Connector (LAN1~LAN2)

Table A.6: Ethernet RJ-45 Connector Pin Assigns

Pin	10/100/1000 MB Base-T Signal Name
1	XMT+
2	XMT-
3	RCV+
4	NC
5	NC
6	RCV-
7	NC
8	NC

A.6 Power Screw Terminal

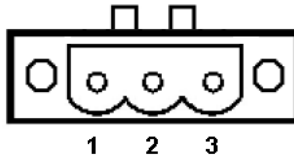

Table A.7: Phoenix Power Connector Pin Assigns

Pin	Signal Name
1	VIN (9 ~ 36 VDC)
2	GND
3	Field Ground

A.7 PS/2 Keyboard and Mouse Connector

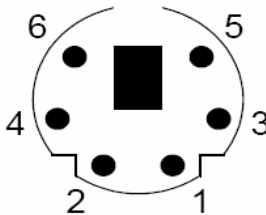

Table A.8: Keyboard & Mouse Connector Pins

Pin	Signal Name
1	KB DATA
2	MS DATA
3	GND
4	VCC
5	KB Clock
6	MS Clock

A.8 USB Connector (USB1~USB4)

Table A.9: USB Connector Pin Assignments

Pin	Signal Name	Cable Color
1	VCC	Red
2	DATA+	White
3	DATA-	Green
4	GND	Black

A.9 VGA Display Connector

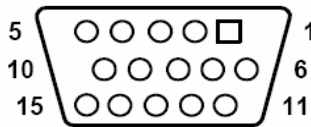

Table A.10: VGA Adaptor Cable Pin Assignmen

Pin	Signal Name
1	Red
2	Green
3	Blue
4	NC
5	GND
6	GND
7	GND
8	GND
9	NC
10	GND
11	NC
12	NC
13	H-SYNC
14	V-SYNC
15	NC

A.10 DVI-I Connector

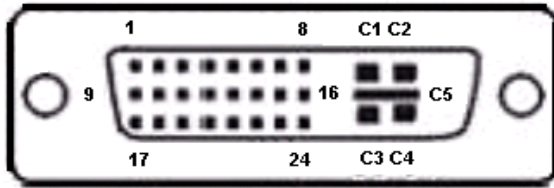
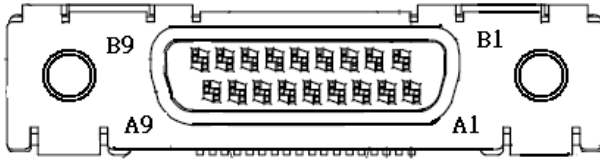

Table A.11: DVI-I connector pin assignment

Pin	Signal Name
1	TMDS_C2#
2	TMDS_C2
3	GND
4	CRT_DDC_CLK
5	CRT_DDC_DATA
6	MDVI_CLK
7	MDVI_DATA
8	VGAVSY
9	TMDS_C1#
10	TMDS_C1
11	GND
12	-
13	-
14	VCC_DVI
15	VGA Detect
16	HP_DET
17	TMDS_C0#
18	TMDS_C0
19	GND
20	-
21	-
22	GND
23	TMDS_CK#
24	TMDS_CK
C1	VGAR
C2	VGAG
C3	VGAB
C4	VHAHSY
C5	GND

A.11 PCI-express Connector (Optional)



Pin	Signal Name
A1	BPCIE_RX2N
A2	BPCIE_RX2P
A3	-
A4	GND
A5	BPCI_E_1_REFN
A6	BPCI_E_1_REFP
A7	GND
A8	CPERST#
A9	GND
B1	GND
B2	-
B3	CWAKE#
B4	CPRSNT#
B5	GND
B6	+3V
B7	+3V
B8	BPCIE_TX2N
B9	BPCIE_TX2P

APPENDIX

B

Programming the Watchdog Timer

Appendix B Programming the Watchdog Timer

To program the watchdog timer, you must write a program which writes I/O port address 443 (hex). The output data is a value of time interval. The value range is from 01 (hex) to 3E (hex), and the related time interval is 1 sec. to 62 sec.

Data	Time Interval
01	1 sec.
02	2 sec.
03	3 sec.
04	4 sec.
..	
..	
..	
3E	62 sec.

After data entry, your program must refresh the watchdog timer by rewriting the I/O port 443 (hex) while simultaneously setting it. When you want to disable the watchdog timer, your program should read I/O port 443 (hex).

The following example shows how you might program the watchdog timer in BASIC:

```
10  REM Watchdog timer example program
20  OUT &H443, data REM Start and restart the watchdog
30  GOSUB 1000 REM Your application task #1,
40  OUT &H443, data REM Reset the timer
50  GOSUB 2000 REM Your application task #2,
60  OUT &H443, data REM Reset the timer
70  X=INP (&H443) REM, Disable the watchdog timer
80  END

1000 REM Subroutine #1, your application task
..
..
..
1070 RETURN

2000 REM Subroutine #2, your application task
..
..
..
2090 RETURN
```

