

# **PPC-L127T**

**Intel® Celeron® M Processor-  
based Fanless Panel PC with  
12.1" TFT-LCD**

## **User Manual**

## Copyright

This document is copyrighted, © 2007. All rights are reserved. The original manufacturer reserves the right to make improvements to the products described in this manual at any time without notice.

No part of this manual may be reproduced, copied, translated or transmitted in any form or by any means without the prior written permission of the original manufacturer. Information provided in this manual is intended to be accurate and reliable. However, the original manufacturer assumes no responsibility for its use, nor for any infringements upon the rights of third parties that may result from such use.

## Acknowledgements

Award is a trademark of Award Software International, Inc.

Intel and Celeron are trademarks of Intel Corporation.

IBM, PC/AT, PS/2 and VGA are trademarks of International Business Machines Corporation.

Intel and Pentium are trademarks of Intel Corporation.

Microsoft Windows is a registered trademark of Microsoft Corp.

RTL is a trademark of Realtek Semiconductor Co., Ltd.

All other product names or trademarks are properties of their respective owners.

For more information on this and other Advantech products, please visit our websites at: **<http://www.advantech.com>**

**<http://www.advantech.com/ppc>**

For technical support and service, please visit our support website at:

**<http://support.advantech.com>**

This manual is for the PPC-L127T.

Part No. 2006L12700

1st Edition, Printed in Taiwan, December 2007

## FCC Class B

This equipment has been tested and found to comply with the limits for a Class B digital device, pursuant to Part 15 of the FCC Rules. These limits are designed to provide reasonable protection against harmful interference when the equipment is operated in a residential environment. This equipment generates, uses and can radiate radio frequency energy. If not installed and used in accordance with this user manual, it may cause harmful interference to radio communications. Note that even when this equipment is installed and used in accordance with this user manual, there is still no guarantee that interference will not occur. If this equipment is believed to be causing harmful interference to radio or television reception, this can be determined by turning the equipment on and off. If interference is occurring, the user is encouraged to try to correct the interference by one or more of the following measures:

- Reorient or relocate the receiving antenna
- Increase the separation between the equipment and the receiver
- Connect the equipment to a power outlet on a circuit different from that to which the receiver is connected
- Consult the dealer or an experienced radio/TV technician for help

**Warning!** *Any changes or modifications made to the equipment which are not expressly approved by the relevant standards authority could void your authority to operate the equipment.*



## **Packing List**

---

Before you begin installing your card, please make sure that the following materials have been shipped:

- PPC-L127T series panel PC
- User manual
- Accessories for PPC-L127T
  - Y-shaped adapter for PS/2 mouse and keyboard
  - Warranty card
  - DC plug-in housing (female) is connected on the AC/DC power adapter
  - Driver CD-ROM disc
  - Mounting kits and packet of screws

If any of these items are missing or damaged, contact your distributor or sales representative immediately.

## **Additional Information and Assistance**

---

Step 1. Visit the Advantech web site at **[www.advantech.com](http://www.advantech.com)** where you can find the latest information about the product.

Step 2. Contact your distributor, sales representative, or Advantech's customer service center for technical support if you need additional assistance. Please have the following information ready before you call:

- Product name and serial number
- Description of your peripheral attachments
- Description of your software (operating system, version, application software, etc.)
- A complete description of the problem
- The exact wording of any error messages

**Caution!**



*Danger of explosion if battery is incorrectly replaced. Replace only with the same or equivalent type recommended by the manufacturer. Dispose of used batteries according to the manufacturer's instructions.*

**Warning!**



- 1. Input voltage rated 12 ~ 25 V, 4.5A max*
- 2. Use a 3 V @ 195 mA lithium battery*
- 3. Packing: please carry the unit with both hands, handle with care*
- 4. Maintenance: to properly maintain and clean the surfaces, use only approved products or clean with a dry applicator*
- 5. CompactFlash: Turn off power before inserting or removing CompactFlash storage card.*

**Contact information:**

Our European representative:

Advantech Europe GmbH

Kolberger Straße 7

D-40599 Düsseldorf, Germany

Tel: 49-211-97477350

Fax: 49-211-97477300

## Safety Instructions

---

1. Read these safety instructions carefully.
2. Keep this User Manual for later reference.
3. Disconnect this equipment from any AC outlet before cleaning. Use a damp cloth. Do not use liquid or spray detergents for cleaning.
4. For plug-in equipment, the power outlet socket must be located near the equipment and must be easily accessible.
5. Keep this equipment away from humidity.
6. Put this equipment on a reliable surface during installation. Dropping it or letting it fall may cause damage.
7. The openings on the enclosure are for air convection. Protect the equipment from overheating. **DO NOT COVER THE OPENINGS.**
8. Make sure the voltage of the power source is correct before connecting the equipment to the power outlet.
9. Position the power cord so that people cannot step on it. Do not place anything over the power cord.
10. All cautions and warnings on the equipment should be noted.
11. If the equipment is not used for a long time, disconnect it from the power source to avoid damage by transient overvoltage.
12. Never pour any liquid into an opening. This may cause fire or electrical shock.
13. Never open the equipment. For safety reasons, the equipment should be opened only by qualified service personnel.
14. If one of the following situations arises, get the equipment checked by service personnel:
  - a. The power cord or plug is damaged.
  - b. Liquid has penetrated into the equipment.
  - c. The equipment has been exposed to moisture.
  - d. The equipment does not work well, or you cannot get it to work according to the user manual.
  - e. The equipment has been dropped and damaged.
  - f. The equipment has obvious signs of breakage.
15. **DO NOT LEAVE THIS EQUIPMENT IN AN ENVIRONMENT WHERE THE STORAGE TEMPERATURE MAY GO BELOW -20° C (-4° F) OR ABOVE 60° C (140° F). THIS COULD DAMAGE THE EQUIPMENT. THE EQUIPMENT SHOULD BE IN A CONTROLLED ENVIRONMENT.**
16. **CAUTION: DANGER OF EXPLOSION IF BATTERY IS INCORRECTLY REPLACED. REPLACE ONLY WITH THE SAME OR EQUIVALENT TYPE RECOMMENDED BY THE MANUFACTURER, DISCARD USED BATTERIES ACCORDING TO THE MANUFACTURER'S INSTRUCTIONS.**

The sound pressure level at the operator's position according to IEC 704-1:1982 is no more than 70 dB (A).

DISCLAIMER: This set of instructions is given according to IEC 704-1. Advantech disclaims all responsibility for the accuracy of any statements contained herein.

## Wichtige Sicherheitshinweise

---

1. Bitte lesen sie Sich diese Hinweise sorgfältig durch.
2. Heben Sie diese Anleitung für den späteren Gebrauch auf.
3. Vor jedem Reinigen ist das Gerät vom Stromnetz zu trennen. Verwenden Sie Keine Flüssig-oder Aerosolreiniger. Am besten dient ein angefeuchtetes Tuch zur Reinigung.
4. Die Netzanschlussteckdose soll nahe dem Gerät angebracht und leicht zugänglich sein.
5. Das Gerät ist vor Feuchtigkeit zu schützen.
6. Bei der Aufstellung des Gerätes ist auf sicheren Stand zu achten. Ein Kippen oder Fallen könnte Verletzungen hervorrufen.
7. Die Belüftungsöffnungen dienen zur Luftzirkulation die das Gerät vor überhitzung schützt. Sorgen Sie dafür, daß diese Öffnungen nicht abgedeckt werden.
8. Beachten Sie beim Anschluß an das Stromnetz die Anschlußwerte.
9. Verlegen Sie die Netzanschlusbleitung so, daß niemand darüber fallen kann. Es sollte auch nichts auf der Leitung abgestellt werden.
10. Alle Hinweise und Warnungen die sich am Geräten befinden sind zu beachten.
11. Wird das Gerät über einen längeren Zeitraum nicht benutzt, sollten Sie es vom Stromnetz trennen. Somit wird im Falle einer Überspannung eine Beschädigung vermieden.
12. Durch die Lüftungsöffnungen dürfen niemals Gegenstände oder Flüssigkeiten in das Gerät gelangen. Dies könnte einen Brand bzw. elektrischen Schlag auslösen.
13. Öffnen Sie niemals das Gerät. Das Gerät darf aus Gründen der elektrischen Sicherheit nur von autorisiertem Servicepersonal geöffnet werden.
14. Wenn folgende Situationen auftreten ist das Gerät vom Stromnetz zu trennen und von einer qualifizierten Servicestelle zu überprüfen:
  - a - Netzkabel oder Netzstecker sind beschädigt.
  - b - Flüssigkeit ist in das Gerät eingedrungen.
  - c - Das Gerät war Feuchtigkeit ausgesetzt.
  - d - Wenn das Gerät nicht der Bedienungsanleitung entsprechend funktioniert oder Sie mit Hilfe dieser Anleitung keine Verbesserung erzielen.
  - e - Das Gerät ist gefallen und/oder das Gehäuse ist beschädigt.
  - f - Wenn das Gerät deutliche Anzeichen eines Defektes aufweist.
15. VORSICHT: Explosionsgefahr bei unsachgemabem Austausch der Batterie.Ersatz nur durch denselben oder einem vom Hersteller empfohlene-mähnlichen Typ. Entsorgung gebrauchter Batterien navh Angaben des Herstellers.

Der arbeitsplatzbezogene Schalldruckpegel nach DIN 45 635 Teil 1000 beträgt 70dB(A) oder weiger.

DISCLAIMER: This set of instructions is given according to IEC704-1. Advantech disclaims all responsibility for the accuracy of any statements contained herein.





# Contents

<b>Chapter</b>	<b>1</b>	<b>General Information .....</b>	<b>2</b>
	1.1	Introduction .....	2
	1.2	General Specifications .....	3
	1.3	LCD Specifications .....	6
	1.4	Dimensions .....	7
		Figure 1.1:Dimensions of PPC-L127T .....	7
<b>Chapter</b>	<b>2</b>	<b>System Setup.....</b>	<b>10</b>
	2.1	A Quick Tour of the Panel PC .....	10
		Figure 2.1:Front view of PPC-L127T panel PC .....	10
		Figure 2.2:Rear view of Panel PC .....	11
		Figure 2.3:Side view of the panel PC .....	11
		Figure 2.4:Bottom view of the panel PC .....	12
	2.2	Installation Procedures .....	12
	2.2.1	Connecting the power cord (Optional item: PS-DC19-L60)12	
	2.2.2	Connecting the keyboard or mouse .....	12
	2.2.3	Switching on the power .....	12
		Figure 2.5:Connect the power cord to the DC inlet.....	13
	2.3	Running the BIOS Setup Program .....	13
	2.4	Installing System Software.....	14
	2.4.1	Method 1: Use the Ethernet .....	14
	2.4.2	Method 2: Use the COM or parallel port.....	14
	2.4.3	Method 3: Use a CD-ROM.....	14
	2.5	Installing the Drivers.....	15
<b>Chapter</b>	<b>3</b>	<b>Hardware Installation and Upgrading.....</b>	<b>18</b>
	3.1	Introduction .....	18
	3.2	Installing the 2.5" Hard Disk Drive (HDD) .....	18
		Figure 3.1:Installing primary 2.5" HDD.....	19
	3.3	Installing the battery pack .....	20
		Figure 3.2:Installing the battery pack .....	20
<b>Chapter</b>	<b>4</b>	<b>Jumper Settings and Connectors.....</b>	<b>22</b>
	4.1	Jumpers and Connectors.....	22
	4.1.1	Setting jumpers .....	22
	4.1.2	Jumpers and connectors .....	23
		Table 4.1:Table 4.1: Jumpers and Connector functions	23

4.1.3	Locating jumpers and connectors .....	24
	Figure 4.1:Jumpers and Connectors on the PPC-L127T motherboard	24
4.2	CMOS Clear for External RTC (JP1) .....	25
	Table 4.2:CMOS clear (J1).....	25
4.2.1	COM1/COM2/COM3/COM4 pin 9 output setting (JP2; JP3)	26
	Table 4.3:COM1/ COM2/COM3/COM4 pin 9 output set- ting (JP2; JP3)	26
4.3	VGA Interface .....	26
4.3.1	LCD panel power setting .....	26

## **Appendix A Pin Assignments .....28**

A.1	Keyboard and PS/2 Mouse Connector (CN20).....	28
	Table A.1:Keyboard and mouse connector (CN20) .....	28
A.2	USB port (CN12) .....	28
	Table A.2:USB port (CN12).....	28
A.3	COM1 RS-232 serial port (CN30) .....	28
	Table A.3:COM1 RS-232 serial port (CN30).....	28
A.4	COM2 (CN22).....	29
	Table A.4:COM2 (CN22).....	29
A.5	COM3 RS-232 serial port (CN31) .....	29
	Table A.5:COM3 RS-232 serial port (CN31).....	29
A.6	COM4 RS-232 serial port (CN23) .....	30
	Table A.6:COM3 RS-232 serial port (CN23).....	30
A.7	Parallel Port Connector (CN29) .....	30
	Table A.7:Parallel Port Connector (CN29).....	30
A.8	VGA Connector (CN2) .....	31
	Table A.8:VGA connector (CN2).....	31
A.9	PCI/ISA Bus connector (Slot 1) .....	32
	Figure A.1:PCI/ISA connector (Side View).....	32
	Table A.9:PCI/ISA pin assignments (Pins A and B)....	33
	Table A.10:PCI/ISA pin assignments (Pins C and D) ..	34
	Table A.11:PCI/ISA pin assignments (Pins E and F)...	35
	Table A.12:PCI/ISA pin assignments (Pins G and H) ..	36

## General Information

This chapter gives background information on the PPC-L127T panel PC.

Sections include:

- Introduction
- General Specifications
- LCD Specifications
- Dimensions

# Chapter 1 General Information

## 1.1 Introduction

---

The PPC-L127T panel PC is an Intel low-power Celeron M processor computer that is designed to serve as a human machine interface (HMI) and as a multimedia computer. It is a PC-based system with 12.1" color TFT LCD display, on-board PCI Ethernet controller, multi-COM port interfaces and an audio controller. With a built-in internal IDE connectors, and an optional PCI/ISA expansion socket, the PPC-L127T is as compact and user friendly as a multi-function computer. In addition, its "fit anywhere" design makes it very flexible and able to be used in many different kinds of installations. It can be wall mounted, panel mounted or stood upright on a desktop.

For system integrators, this simple, complete, compact and highly integrated multimedia system lets you easily build a panel PC into your applications. Common industrial applications include factory automation systems, precision machinery, and production process control. It is also suitable for many nonindustrial applications, including interactive kiosk systems, entertainment management, and car park automation. Our panel PC is a reliable, cost-effective solution to your application's processing requirements.

## 1.2 General Specifications

---

### General

- **Dimensions (W x H x D):** 340.5 x 269.3 x 70.5 mm
- **Weight:** 3.25 kg
- **Power supply:** ATX type

Input Voltage: +12 ~ 25 VDC, 4.5A Max.

### Power adaptor: AC/DC (Optional PS-DC19-L60)

Input voltage: 100 ~ 240 V<sub>AC</sub>

Output voltage: 19 V @ 3.16 A

- **Disk drive housing:** Space for one 2.5" HDD, one slim type CD-ROM
- **Front panel:** IP65/NEMA4 compliant

### Standard PC functions

- **CPU:** On board Intel ULV Celeron M 1GHz with 0 L2 cache / Intel UL Celeron M 1GHz with 512 L2 cache (Optional)
- **BIOS:** Award 4 Mbit flash BIOS, ACPI 2.0 Compliant
- **System Chipset:** Intel 852GM + ICH4, Or Intel 855GME + ICH4 (Optional)
- **Front side bus:** 400 MHz
- **2nd level cache:** Nona / 512 KB (Optional)
- **System Memory:** One 184-pin DIMM socket, accepting up to 1GB DDR 200/266
- **PCI bus master IDE interface:** Supports two connectors. Each connector has one channel and supports two IDE devices. Each channel supports PIO modes 0 ~ 4, DMA mode 0 ~ 2, and Ultra DMA 33/66/100 simultaneously. The secondary connector is designated for the CD-ROM drive or CompactFlash card. BIOS supports IDE CDRom boot-up.
- **Keyboard/mouse connector:** Supports PS/2 Keyboard and Mouse
- **Parallel port:** One parallel port, supports SPP/EPP/ECP parallel mode.
- **Serial ports:** Four serial ports with three RS-232 ports (COM 1,3, and 4), one RS-232/422/485 port (COM2). All ports are compatible with 16C550 UARTs, +5V/+12V power supply selectable
- **Universal serial bus (USB) port:** Support Up to 6 USB V2.0 ( 4 x external, 2 x internal. One is reserved for T/S function.

- **PCI/ISA bus expansion slot (optional):** Accepts either one ISA card or one PCI bus card
- **Mini PCI bus expansion slot:** Accepts one type III mini PCI bus card
- **Solid State Disk:** Supports one 50-pin socket for CompactFlash type I/II (True IDE mode)
- **Watchdog timer:** 255-level timer intervals, from 15 sec to 14835 sec, setup by software, jumperless selection, generates system reset
- **Battery:** 3.0 V @ 195 mA lithium battery
- **Power management:** Supports power saving modes including Normal/Standby/Suspend modes. APM 1.2 compliant

### VGA/LCD Interface

- **Chipset:** Integrated in Intel 852GM or Intel 855GME (Optional)
- **Frame buffer:** Supports 64 MB frame buffer with system memory
- **Interface:** VGA/ LCD interface, support for 18-bit TFT
- **Display mode:** CRT Modes: 1600 x 1200 @ 16bpp (60 Hz), 1024 x 768 @ 32bpp (85 Hz); LCD/Simultaneous Modes: 800 x 600; 1024 x 768 @ 16bpp (60 Hz)

### Audio function

- **Chipset:** Intel ICH4 South Bridge
- **Audio controller:** ALC650 AC97 Ver 2.0 compliant interface, Multi-stream Direct sound and Direct Sound 3D acceleration
- **Stereo sound:** 20-bit full-duplex codec
- **Audio interface:** Microphone in, Line in, CD audio in; Line out, Speaker L, Speaker R

### PCI bus Ethernet interface

- **Chipset:** Realtek RTL 8100CL PCI local bus Ethernet controller
- **Ethernet interface:** Full compliance with IEEE 802.3u 100Base-T and 10 Base-T specifications. Includes software drivers and boot ROM
- **100/10Base-T auto-sensing capability**
- **Wake-on-LAN:** Supports Wake-on-LAN function with ATX power control

## Touchscreen (Optional)

<b>Type</b>	Analog Resistive
<b>Resolution</b>	Continuous
<b>Light Transmission</b>	80%
<b>Controller</b>	USB interface
<b>Power Consumption</b>	<5 V@ 60 mA
<b>Software Driver</b>	Supports Windows NT/98/ 2000/ME/XP
<b>Durability (touches in a lifetime)</b>	35 million

*Note: The panel PC with the optionally installed touchscreen will share the COM4 port. Once the touchscreen is installed, COM4 cannot be used for other purposes.*

### Optional modules

- **Memory:** One 184-pin DIMM socket, accepting up to 1 GB DDR 200/266
- **CD-ROM Module:** Slim type CD-ROM Module 989KL12711E
- **Combo Module:** Slim type Combo Module 989KL12710E
- **Adaptor:** PS-DC19-L60
- **HDD:** 2.5" HDD
- **Operating System:** Microsoft® DOS, Windows 2000, XP, NT
- **Touchscreen:** Analog resistive
- **Battery pack:** Rechargeable Li-ion 3S2P 11.1 V 4400 mAh PPC-BP-LTC4006E

### Environment

- **Operating Temperature:** 0 ~ 50° C (32 ~ 122° F)
- **Storage Temperature:** -20 ~ 60° C

- **Relative humidity:** 10 ~ 95% @ 40° C (non-condensing)
- **Shock:** 10 G peak acceleration (11 ms duration)
- **Certification:** EMC: CE, FCC, BSMI. Safety: UL 60950, CB, CCC, BSMI
- **Vibration:** 5 ~ 500 Hz 1 G RMS Random vibration

### 1.3 LCD Specifications

---

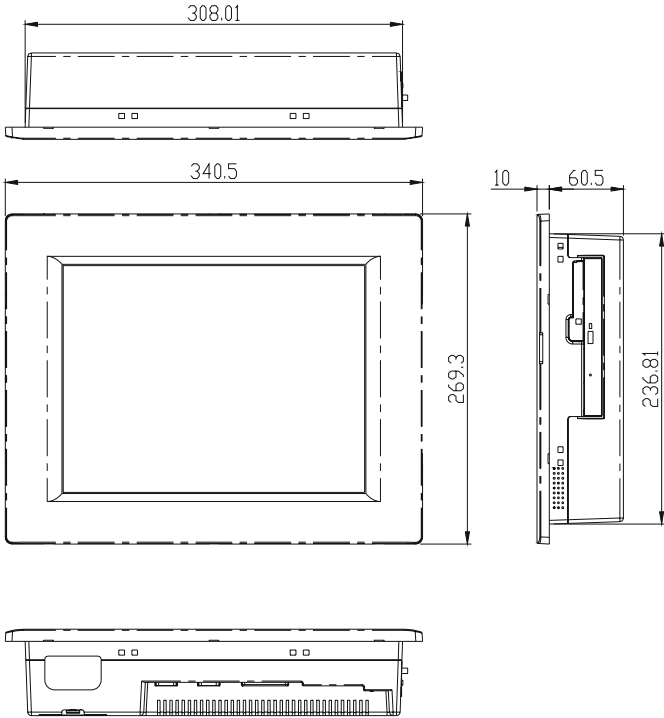
- **Display type:** 12.1" TFT LCD
- **Max. resolution:** 800 x 600
- **Colors:** 262 K
- **Dot size (mm):** 0.3075 x 0.3075
- **Viewing angle:** 70° (left), 70° (right), 60° (up), 50° (down)
- **Luminance:** 400 cd/m<sup>2</sup>
- **Temperature:** -10 ~ 65° C
- **\*VR control:** Brightness
- **Backlight lifetime:** 50,000 hours
  - \* The VR control is defined by hot key in DOS or BIOS mode as below: Ctrl-Alt-F3, Ctrl-Alt-F4.

*Note: The color LCD display installed in the panel PC is high-quality and reliable. However, it may contain a few defective pixels which do not always illuminate. With current technology, it is impossible to completely eliminate defective pixels. Advantech is actively working to improve this technology.*



## 1.4 Dimensions

---



*Figure 1.1: Dimensions of PPC-L127T*



## **System Setup**

This chapter details system setup on the PPC-L127T panel PC.

Sections include:

- A Quick Tour of the Panel PC
- Installation procedures
- Running the BIOS Setup Program
- Installing System Software
- Installing the Drivers

# Chapter 2 System Setup

## 2.1 A Quick Tour of the Panel PC

---

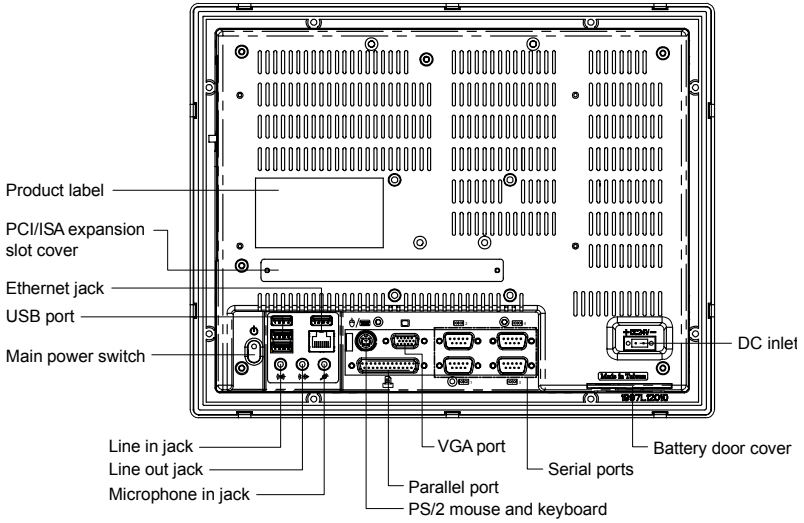
Before you start to set up the panel PC, take a moment to become familiar with the locations and purposes of the controls, drives, connectors and ports, which are illustrated in the figures below.

When you place the panel PC upright on the desktop, its front panel appears as shown in Figure 2-1.

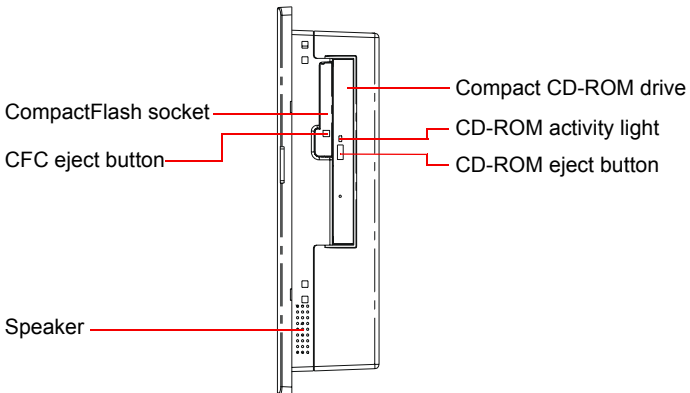


*Figure 2.1: Front view of PPC-L127T panel PC*

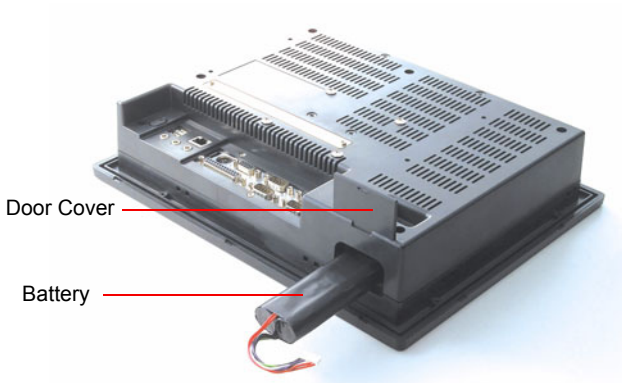
When you turn the panel PC around and look at its rear cover, you will find the I/O section as shown in Fig. 2-2. (The I/O section includes various I/O ports, including serial ports, parallel port, the Ethernet port, USB ports, the Line-in/Line-out jack, and so on.) The battery door cover is at the bottom of the panel PC, as shown in Fig. 2-4.



**Figure 2.2: Rear view of Panel PC**



**Figure 2.3: Side view of the panel PC**



*Figure 2.4: Bottom view of the panel PC*

## 2.2 Installation Procedures

---

### 2.2.1 Connecting the power cord (Optional item: PS-DC19-L60)

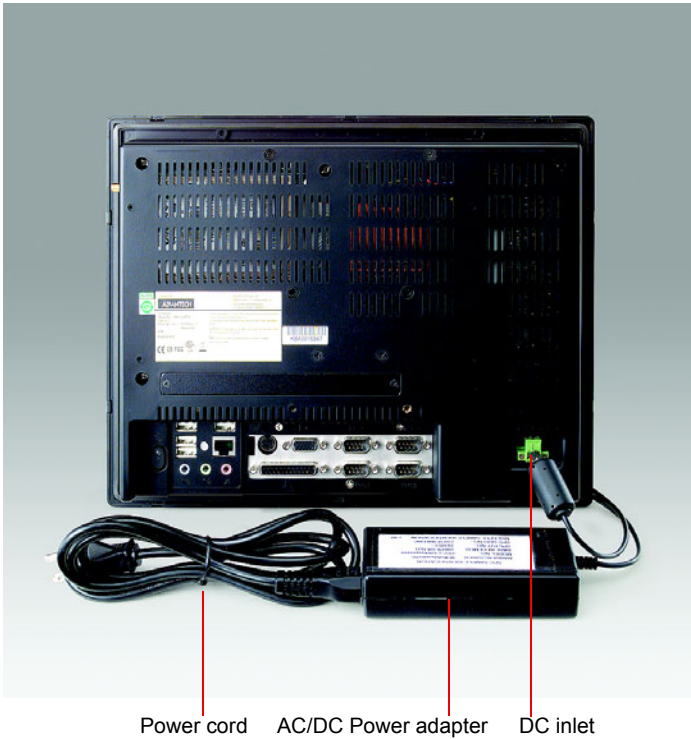
The panel PC can only be powered by a DC electrical outlet. Be sure to always handle the power cords by holding the plug ends only. Please follow the Figure 2-5 to connect the male plug of the power cord to the DC inlet of the panel PC.

### 2.2.2 Connecting the keyboard or mouse

Before you start the computer, please connect the Y-shaped adaptor to the PS/2 mouse and keyboard port on the I/O section of the panel PC, then connect the necessary mouse or keyboard to the Y-shaped adaptor or serial ports.

### 2.2.3 Switching on the power

When you look at the rear side of the panel PC, you will see the power switch as shown in Figure 2-2.



*Figure 2.5: Connect the power cord to the DC inlet*

## 2.3 Running the BIOS Setup Program

---

Your panel PC is likely to have been properly set up and configured by your dealer prior to delivery. You may still find it necessary to use the panel PC's BIOS (Basic Input-Output System) setup program to change system configuration information, such as the current date and time or your type of hard drive. The setup program is stored in read-only memory (ROM). It can be accessed either when you turn on or reset the panel PC, by pressing the “Del” key on your keyboard immediately after powering on the computer.

The settings you specify with the setup program are recorded in a special area of memory called CMOS RAM. This memory is backed up by a bat-

tery so that it will not be erased when you turn off or reset the system. Whenever you turn on the power, the system reads the settings stored in CMOS RAM and compares them to the equipment check conducted during the power on self-test (POST). If an error occurs, an error message will be displayed on screen, and you will be prompted to run the setup program.

If you want to change the setup of BIOS, refer to Chapter 9 for more detailed information.

## 2.4 Installing System Software

---

Recent releases of operating systems from major vendors include setup programs which load automatically and guide you through hard disk preparation and operating system installation. The guidelines below will help you determine the steps necessary to install your operating system on the panel PC hard drive.

*Note: Some distributors and system integrators may have already pre-installed system software prior to shipment of your panel PC.*

Installing software requires an installed HDD. Software can be loaded in the PPC-L127T using any of four methods:

### 2.4.1 Method 1: Use the Ethernet

You can use the Ethernet port to download software to the HDD.

### 2.4.2 Method 2: Use the COM or parallel port

You can use Lap Link 6 or similar transmission software. Connect another PC to the PPC-L127T with an appropriate cable and transmit the software to the PPC-L127T.

### 2.4.3 Method 3: Use a CD-ROM

If required, insert your operating system's installation or setup diskette into the diskette drive until the release button pops out.

The BIOS of the panel PC supports system boot-up directly from the CD-ROM drive. You may also insert your system installation CD-ROM into the CD-ROM drive.

Power on your panel PC or reset the system by pressing the "Ctrl+Alt+Del" keys simultaneously. The panel PC will automatically load the operating system from the diskette or CD-ROM.



If you are presented with the opening screen of a setup or installation program, follow the instructions on screen. The setup program will guide you through preparation of your hard drive, and installation of the operating system. If you are presented with an operating system command prompt, such as A:\>, then you must partition and format your hard drive, and manually copy the operating system files to it. Refer to your operating system user manual for instructions on partitioning and formatting a hard drive.

## 2.5 Installing the Drivers

---

After installing your system software, you will be able to set up the Ethernet, SVGA, audio, and touchscreen functions. All drivers are stored in a CD-ROM disc entitled “Drivers and Utilities” which can be found in your accessory box.

The various drivers and utilities in the CD-ROM disc have their own text files which help users install the drivers and understand their functions. These files are a very useful supplement to the information in this manual.

**Note:** *The drivers and utilities used for the PPC-L127T panel PCs are subject to change without notice. If in doubt, check Advantech's website or contact our application engineers for the latest information regarding drivers and utilities.*



## **Hardware Installation and Upgrading**

This chapter details installing the PPC-L127T panel PC hardware.

Sections include:

- Overview of Hardware Installation and Upgrading
- Installing the 2.5" Hard Disk Drive (HDD)
- Installing the battery pack

# Chapter 3 Hardware Installation and Upgrading

## 3.1 Introduction

---

The panel PC consists of a PC-based computer that is housed in a plastic rear panel and a metal shielding case. You can install a HDD, DRAM, and battery pack by removing the rear panel and shielding case. Any maintenance or hardware upgrades can be easily completed after removing the rear panel and shielding case.

If you are a systems integrator and need to know how to completely disassemble the panel PC, you can find more useful information in Appendix C.

**Warning!** *Do not remove the plastic rear cover until you have verified that no power is flowing within the panel PC. Power must be switched off and the power cord must be unplugged. Every time you service the panel PC, you should be aware of this.*



## 3.2 Installing the 2.5" Hard Disk Drive (HDD)

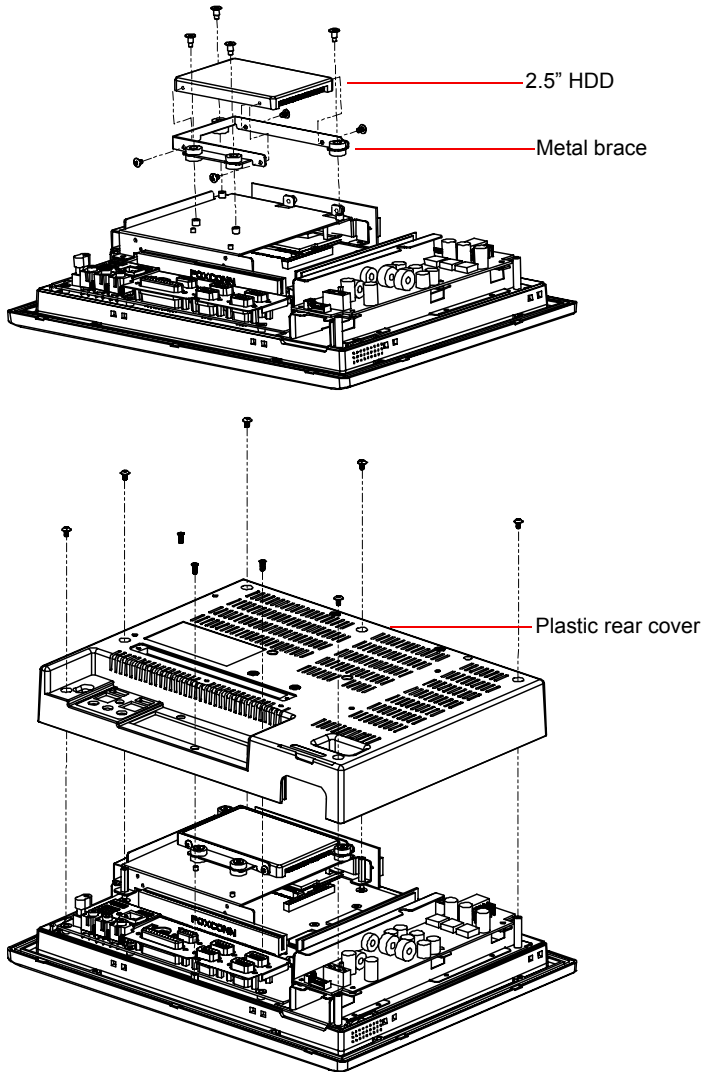
---

You can attach one enhanced Integrated Device Electronics (IDE) hard disk drive to the panel PC's internal controller which uses a PCI local-bus interface. The advanced IDE controller supports faster data transfer and allows the IDE hard drive to exceed 528 MB. The following are instructions for installation:

1. Detach and remove the plastic rear cover.
2. There is a metal brace which holds the HDD to the upper left-hand side of the metal shielding case. (See Fig. 3-1.)
3. Place the HDD in the metal brace, and tighten the screws.
4. The HDD cable (1 x 44-pin to 1 x 44-pin) is next to the metal brace. Connect the HDD cable to the PC board (CN7). Make sure that the red/blue wire corresponds to Pin 1 on the connector, which is labeled on the board. Plug the other end of the cable into the IDE

hard drive, with Pin 1 on the cable corresponding to Pin 1 on the hard drive.

5. Put the plastic rear cover on and tighten the screws.

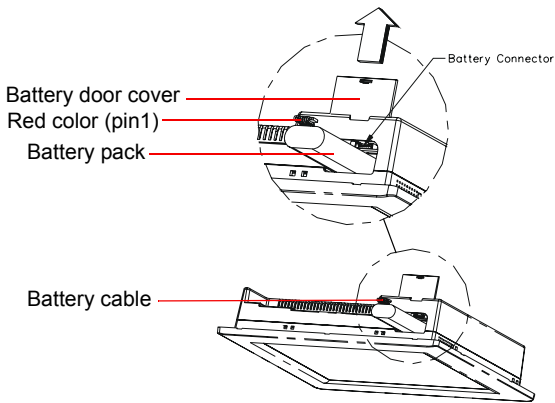


*Figure 3.1: Installing primary 2.5" HDD*

### 3.3 Installing the battery pack

---

1. Pull up the battery door cover on the right bottom of PPC-L127T.
2. Put the battery pack in, then connect the battery cable to battery connector in the PPC-L127T. Make sure the red wire corresponds to Pin 1 on the connector.
3. Close the battery door cover.



**Figure 3.2: Installing the battery pack**

## **Jumper Settings and Connectors**

This chapter tells how to set up the panel PC hardware, including instructions on setting jumpers and connecting peripherals, switches and indicators. Be sure to read all the safety precautions before you begin the installation procedures.

Sections include:

- Jumpers and Connectors
- CMOS Clear for External RTC (J5)
- COM Port Interface
- VGA Interface
- Watchdog Timer Configuration

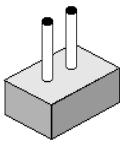
# Chapter 4 Jumper Settings and Connectors

## 4.1 Jumpers and Connectors

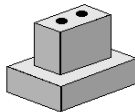
---

### 4.1.1 Setting jumpers

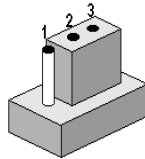
You can configure your panel PC to match the needs of your application by setting jumpers. A jumper is the simplest kind of electrical switch. It consists of two metal pins and a small metal clip (often protected by a plastic cover) that slides over the pins to connect them. To “close” a jumper, you connect the pins with the clip. To “open” a jumper you remove the clip. Sometimes a jumper will have three pins, labeled 1, 2, and 3. In this case, you would connect either pins 1 and 2 or pins 2 and 3.



open

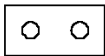


closed



closed 2-3

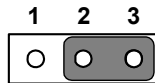
The jumper settings are schematically depicted in this manual as follows:.



open



closed



closed 2-3

A pair of needle-nose pliers may be helpful when working with jumpers. If you have any doubts about the best hardware configuration for your application, contact your local distributor or sales representative before you make any changes.



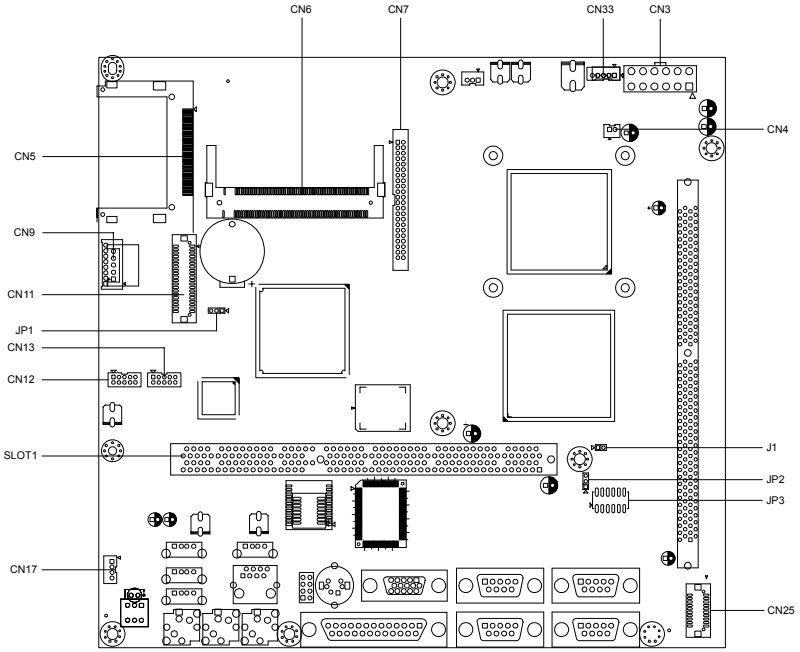
### 4.1.2 Jumpers and connectors

The motherboard of the PPC-L127T has a number of jumpers and connectors that allow you to configure your system to suit your applications. The table below lists the function of each of the board's jumpers.

**Table 4.1: Table 4.1: Jumpers and Connector functions**

CN3	ATX power connector
CN4	Reset button
CN5	CF Slot ,TYPEII
CN6	MINIPCI_124V
CN7	IDE hard drive connector (2.5" HDD)
CN9	Touch Screen connector
CN11	Slim Type CD ROM connector
CN12	Internal USB
CN13	Internal COM Port
CN17	Internal Speaker connector
CN25	LVDS connector
CN33	Inverter power connector
J1	ATX/AT Select
JP1	Clear CMOS
JP2	COM Port PWR
JP3	COM Pin 9 Select
Slot 1	PCI/ISA bus expansion connector

### 4.1.3 Locating jumpers and connectors



*Figure 4.1: Jumpers and Connectors on the PPC-L127T motherboard*

## 4.2 CMOS Clear for External RTC (JP1)

---

**Warning!** To avoid damaging the computer, always turn off the power supply before setting “Clear CMOS”. Set the jumper back to “Normal operation” before turning on the power supply.

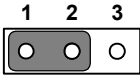
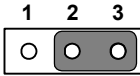


This jumper is used to erase CMOS data and reset system BIOS information.

The procedure for clearing CMOS is:

1. Turn off system.
2. Short pin 2 and pin 3.
3. Return jumper to pins 1 and 2.
4. Turn on the system. The BIOS is now reset to its default setting.

**Table 4.2: CMOS clear (J1)**

* Normal operation	Clear CMOS
	

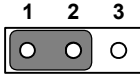
\* Default setting

## 4.2.1 COM1/COM2/COM3/COM4 pin 9 output setting (JP2; JP3)

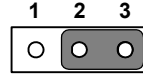
**Table 4.3: COM1/ COM2/COM3/COM4 pin 9 output setting (JP2; JP3)**

### JP2

\* +5V output



+12V output

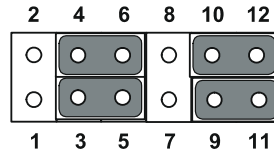
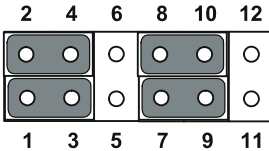


\*Default setting

### JP3

\*Pin 9 = Ring

Pin 9 + 5V or +12V Power output



\*Default setting

- Note:*
- Pins 1, 3 and 5 are dedicated to COM1*
  - Pins 2, 4 and 6 are dedicated to COM2*
  - Pins 7, 9 and 11 are dedicated to COM3*
  - Pins 8, 10 and 12 are dedicated to COM4*

## 4.3 VGA Interface

### 4.3.1 LCD panel power setting

The panel PC's AGP SVGA interface supports 3.3 V LCD displays. The LCD cable already has a built-in default setting. You do not need to adjust any jumper or switch to select the panel power.

Appendix

# A

## I/O Pin Assignments

# Appendix A Pin Assignments

## A.1 Keyboard and PS/2 Mouse Connector (CN20)

**Table A.1: Keyboard and mouse connector (CN20)**

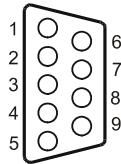
Pin	Signal
1	KB_DAT
2	MS-DAT
3	GND
4	+5 V
5	KB_CLK
6	MS-CLK

## A.2 USB port (CN12)

**Table A.2: USB port (CN12)**

Pin	Signal
1	VCC
2	DATA-
3	DATA+
4	GND

## A.3 COM1 RS-232 serial port (CN30)

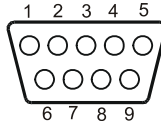


**Table A.3: COM1 RS-232 serial port (CN30)**

Pin	Signal	Pin	Signal
1	DCD	2	RXD
3	TxD	4	DTR
5	GND	6	DSR
7	RTS	8	CTS
9	RI		

## A.4 COM2 (CN22)

---

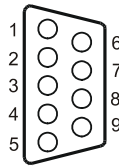


**Table A.4: COM2 (CN22)**

Pin	Signal RS-232	RS-422	RS-485
1	DCD	TX-	DATA-
2	RX	TX+	DATA+
3	TX	RX+	
4	DTR	RX-	
5	GND	GND	
6	DSR		
7	RTS		
8	CTS		
9	RI		

## A.5 COM3 RS-232 serial port (CN31)

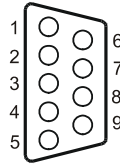
---



**Table A.5: COM3 RS-232 serial port (CN31)**

Pin	Signal	Pin	Signal
1	DCD	2	RXD
3	TxD	4	DTR
5	GND	6	DSR
7	RTS	8	CTS
9	RI		

## A.6 COM4 RS-232 serial port (CN23)



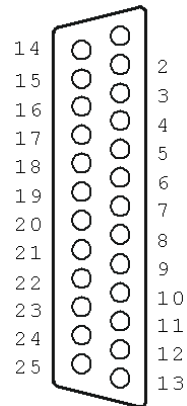
**Table A.6: COM3 RS-232 serial port (CN23)**

Pin	Signal	Pin	Signal
1	DCD	2	RXD
3	TxD	4	DTR
5	GND	6	DSR
7	RTS	8	CTS
9	RI		

## A.7 Parallel Port Connector (CN29)

**Table A.7: Parallel Port Connector (CN29)**

Pin	Signal	Pin	Signal
1	STROBE*	2	D0
3	D1	4	D2
5	D3	6	D4
7	D5	8	D6
9	D7	10	ACK*
11	BUSY	12	PE
13	SLCT	14	AUTOFD*
15	ERR*	16	INIT*
17	SLCTINI*	18	GND
19	GND	20	GND
21	GND	22	GND
23	GND	24	GND
25	GND		



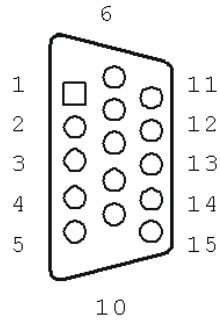
\*Low active



## A.8 VGA Connector (CN2)

**Table A.8: VGA connector (CN2)**

Pin	Signal
1	RED
2	GREEN
3	BLUE
4	N/A
5	GND
6	GND
7	GND
8	GND
9	N/A
10	GND
11	N/A
12	SPDAT
13	HSYNC
14	VSYNC
15	SPCLK



## A.9 PCI/ISA Bus connector (Slot 1)

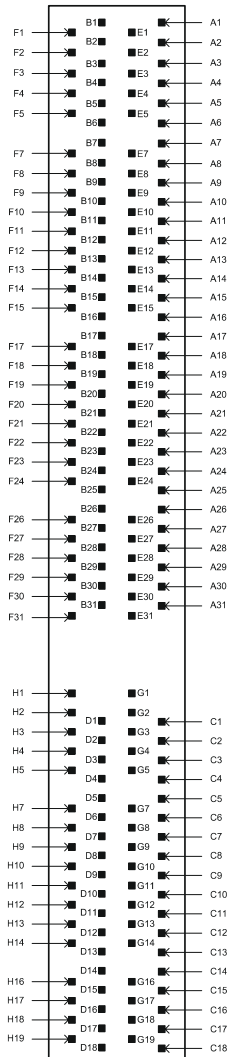


Figure A.1: PCI/ISA connector (Side View)

**Table A.9: PCI/ISA pin assignments (Pins A and B)**

<b>Pin</b>	<b>Signal</b>	<b>Pin</b>	<b>Signal</b>
A1	IOCHK	B1	GND
A2	SD7	B2	RST
A3	SD6	B3	VCC
A4	SD5	B4	IRQ9
A5	SD4	B5	-5 V
A6	SD3	B6	DRQ2
A7	SD2	B7	-12 V
A8	SD1	B8	OVS
A9	SD0	B9	+12 V
A10	IORDY	B10	GND
A11	AEN	B11	SMW
A12	SA19	B12	SMR
A13	SA18	B13	IOW
A14	SA17	B14	IOR
A15	SA16	B15	DACK3
A16	SA15	B16	DRQ3
A17	SA14	B17	DACK1
A18	SA13	B18	DRQ1
A19	SA12	B19	RFSH
A20	SA11	B20	SCLk
A21	SA10	B21	IRQ7
A22	SA9	B22	IRQ6
A23	SA8	B23	IRQ5
A24	SA7	B24	IRQ4
A25	SA6	B25	IRQ3
A26	SA5	B26	DACK2
A27	SA4	B27	TC
A28	SA3	B28	ALE
A29	SA2	B29	VCC
A30	SA1	B30	OSC
A31	SA0	B31	GND

**Table A.10: PCI/ISA pin assignments (Pins C and D)**

<b>Pin</b>	<b>Signal</b>	<b>Pin</b>	<b>Signal</b>
C1	sbhe	D1	mem16
C2	la23	D2	io16
C3	la22	D3	irq10
C4	la21	D4	irq11
C5	la20	D5	irq12
C6	la19	D6	irq15
C7	la18	D7	irq14
C8	la17	D8	dack0
C9	memr	D9	drq0
C10	memw	D10	dack5
C11	sd8	D11	drq5
C12	sd9	D12	dack6
C13	sd10	D13	drq6
C14	sd11	D14	dack7
C15	sd12	D15	drq7
C16	sd13	D16	V <sub>cc</sub>
C17	sd14	D17	master
C18	sd15	D18	gnd

**Table A.11: PCI/ISA pin assignments (Pins E and F)**

<b>Pin</b>	<b>Signal</b>	<b>Pin</b>	<b>Signal</b>
E1	gnd	F1	GND
E2	gnd	F2	gnd
E3	int 1	F3	int3
E4	int 2	F4	int4
E5	v <sub>cc</sub>	F5	v <sub>cc</sub>
E6	—	F6	—
E7	v <sub>cc</sub>	F7	v <sub>cc</sub>
E8	PCIRST	F8	pclk2
E9	GNT1	F9	GND
E10	REQ1	F10	GNT2
E11	gnd	F11	gnD
E12	pclk1	F12	REQ2
E13	gnd	F13	ad31
E14	ad30	F14	ad29
E15	REQ3	F15	nc
E16	—	F16	—
E17	GNT3	F17	nc
E18	ad28	F18	ad27
E19	ad26	F19	ad25
E20	ad24	F20	cbe3
E21	ad22	F21	ad23
E22	ad20	F22	ad21
E23	ad18	F23	ad19
E24	nc	F24	PMF
E25	—	F25	—
E26	NC	F26	VSB3.3
E27	ad16	F27	ad17
E28	frame	F28	irdy
E29	cbe2	F29	devsel
E30	trdy	F30	lock
E31	stop	F31	perr

**Table A.12: PCI/ISA pin assignments (Pins G and H)**

<b>Pin</b>	<b>Signal</b>	<b>Pin</b>	<b>Signal</b>
G1	NC	H1	serr
G2	NC	H2	ad15
G3	cbe1	H3	ad14
G4	par	H4	ad12
G5	gnd	H5	gnd
G6	—	H6	—
G7	gnd	H7	gnd
G8	ad13	H8	ad10
G9	ad11	H9	ad8
G10	ad9	H10	ad7
G11	cbe0	H11	ad5
G12	ad6	H12	ad3
G13	ad4	H13	ad1
G14	ad2	H14	ad0
G15	—	H15	—
G16	$v_{cc}$	H16	$v_{cc}$
G17	$v_{cc}$	H17	$v_{cc}$
G18	gnd	H18	gnd
G19	gnd	H19	gnd