

PCA-6740

ISA Elite® Slot-PC SBC, with 133 MHz CPU/32 MB/VGA/LCD/LAN/DOC and PC/104

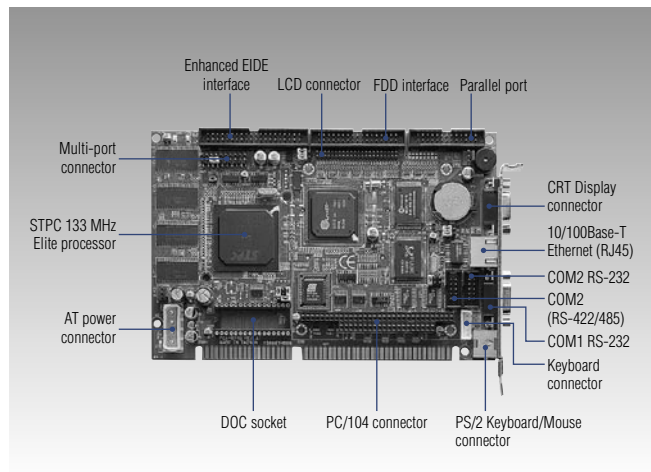

Features

- Low power fanless STPC Elite 133
- Onboard 32 MB SDRAM
- 10/100Base-T Ethernet
- Supports DiskOnChip® 2000 SSD Solution
- Superior low power consumption, requires no CPU cooling fan

Specifications

General

- **CPU** Onboard low power STPC Elite 133 MHz
- **2nd Cache Memory** On processor
- **System Chipset** STPC® Elite embedded
- **BIOS** AWARD® 256 kbit Flash BIOS
- **System Memory** On board 32 MB SDRAM (optional 1 x SDRAM SODIMM, Max. 64 MB)
- **Power Management** APM
- **SSD** DiskOnChip® 2000 (optional CompactFlash® card)
- **Watch Dog Timer** 1 ~ 62 sec., System reset or IRQ11
- **Expansion Interface** 1 x 16-bit ISA slot, 1 x PC/104 connector
- **Battery** Lithium 3 V/196 mAh

I/O

- **I/O Interface** 1 x EIDE (PIO Mode 4), 1 x FDD, 1 x K/B, 1 x Mouse, 1 x LPT
PCA-6740F-0CA2: 1 x RS-232/422/485, 1 x RS-232;
PCA-6740L-0CA2: 2 x RS-232;
- **USB** N/A
- **Audio** N/A
- **IrDA** 115 kbps SIR, IrDA 1.0 compliant
- **GPIO** N/A
- **I/O Expansion** PC/104, ISA

Ethernet

- **Chipset** RTL™ 8139C
- **Speed** 10/100Base-T
- **Interface** 1 x RJ-45
- **Standard** IEEE 802.3u

Built-in boot ROM

Display

- **Chipset** SMI Lynx 712
- **Memory Size** 4 MB
- **Resolution** CRT mode: 1280 x 1024 @ 16 bpp (60 Hz),
1024 x 768 @ 16 bpp, 800 x 600 @ 16 bpp
LCD mode: 1280 x 1024 @ 16 bpp (60 Hz)
1024 x 768 @ 16 bpp, 800 x 600 @ 16 bpp
- **LCD Interface** Up to 36-bit TTL for TFT LCD
- **LVDS Interface** N/A
- **TV-Out** N/A
- **Dual Independent Display** N/A

Mechanical and Environmental

- **Dimension (L x W)** 185 x 122 mm (7.3" x 4.8")
- **Weight** 0.27 kg (weight of total package)
- **Operating Temperature** 0 ~ 60° C (32 ~ 140° F), operation
- **Operating Humidity** 0% ~ 90% relative humidity, non-condensing

Power

- **Power Supply Voltage** +5 V ± 5%
- **Power Consumption** Max : 5 V @ 2 A
Typical : 5 V @ 1.62 A

Board Diagram

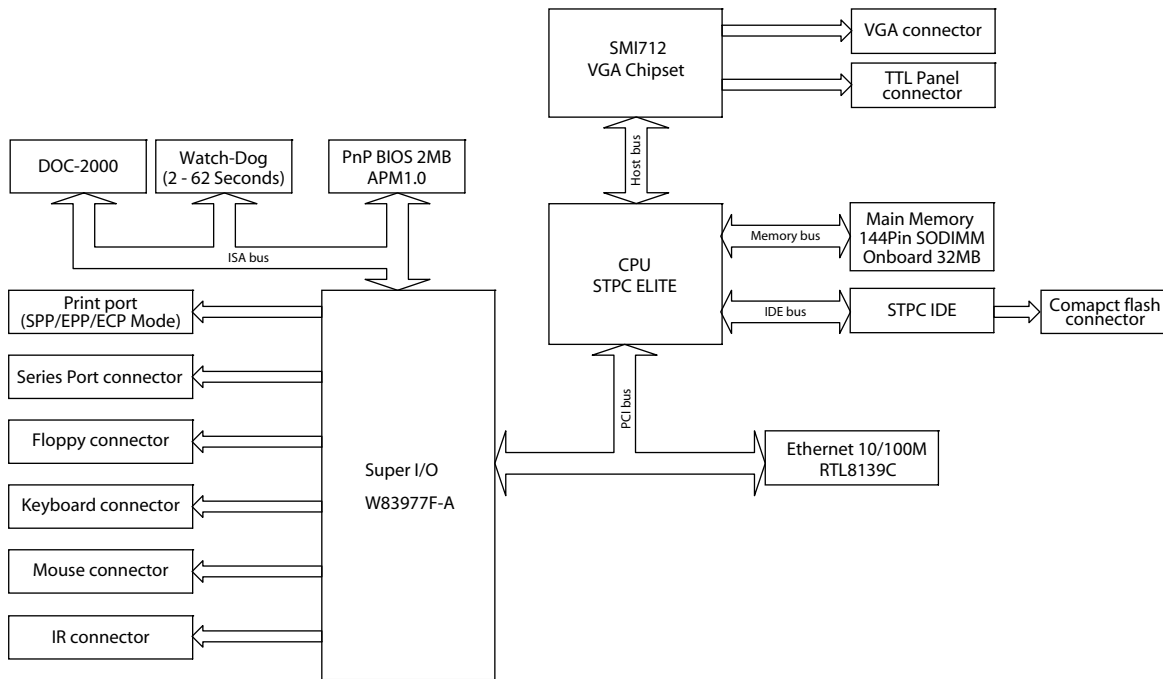

Packing List

- 1 x PCA-6740 SBC
- 1 x Y Cable for PS/2 Keyboard, PS/2 Mouse (p/n:170006020)
- 1 x EIDE (HDD) Cable (600 mm) (p/n:1701400601)
- 1 x FDD Cable (290 mm) (p/n:1701340700)
- 1 x COM2 & Parallel Port Cable Kit (p/n:1701260303)
- 1 x Mini Jumper (p/n:1653300100)
- 1 x Startup Manual
- 1 x Utility CD

Optional Accessories

- PCA-6104-0C2E 4-slot ISA backplane
- PCA-6106-0B2E 6-slot ISA backplane
- PCA-6108-0C2E 8-slot ISA backplane
- IPC-644-15ZE 4-slot ISA chassis w/backplane & 150 W power supply
- IPC-6806-20ZBE 6-slot ISA chassis w/backplane & 200 W power supply
- IPC-6606BP-25ZE ISA chassis with 250 W power supply
- IPC-6606BP-30ZE ISA chassis with 300 W power supply
- 9689000042 IrDA adapter
- CF-HDD-ADP CompactFlash 50-pin to IDE 44-pin adapter

Ordering Information

Standard	CRT	TTL	10/100	USB	RS-232	RS-232/422/485	LPT	IrDA	CF	PC-104
PCA-6740F-OCA2E	1	1	1	--	1	1	1	115 kbps	optional	1
PCA-6740L-OCA2E	1	1	--	--	2	--	1	115 kbps	optional	--