

PCA-6005

**Full-sized PCI-bus
socket 478 Pentium 4/Celeron
processor-based CPU card**

User's Manual

Copyright

This document is copyrighted, 2002. All rights are reserved. The original manufacturer reserves the right to make improvements to the products described in this manual at any time without notice.

No part of this manual may be reproduced, copied, translated or transmitted in any form or by any means without the prior written permission of the original manufacturer. Information provided in this manual is intended to be accurate and reliable. However, the original manufacturer assumes no responsibility for its use, nor for any infringements upon the rights of third parties that may result from such use.

Acknowledgements

AWARD is a trademark of AWARD Software, Inc.

IBM and PC are trademarks of International Business Machines Corporation.

Intel® and Pentium® 4 are trademarks of Intel Corporation.

Windows is a trademark of Microsoft Corporation.

ITE is a trademark of Integrated Technology Express, INC.

SiS is a registered trademark of Silicon Integrated Systems Corp.

Realtek is a trademark of Realtek Semiconductor Corporation

All other product names or trademarks are properties of their respective owners.

Part No. 2002600501
Printed in Taiwan

2nd. Edition
October 2002

A Message to the Customers

Advantech customer services

Each and every Advantech product is built to the most exacting specifications to ensure reliable performance in the harsh and demanding conditions typical of industrial environments. Whether your new Advantech equipment is destined for the laboratory or the factory floor, you can be assured that your product will provide the reliability and ease of operation for which the name Advantech has come to be known. Your satisfaction is our primary concern. Here is a guide to Advantech's customer services. To ensure you get the full benefit of our services, please follow the instructions below carefully.

Technical support

We want you to get the maximum performance from your products. So if you run into technical difficulties, we are here to help. For the most frequently asked questions, you can easily find answers in your product documentation. These answers are normally a lot more detailed than the ones we can give over the phone. So please consult this manual first. If you still cannot find the answer, gather all the information or questions that apply to your problem, and with the product close at hand, call your dealer. Our dealers are well trained and ready to give you the support you need to get the most from your Advantech products. In fact, most problems reported are minor and are able to be easily solved over the phone. In addition, free technical support is available from Advantech engineers every business day. We are always ready to give advice on application requirements or specific information on the installation and operation of any of our products.

PCA-6005 Comparison Table

Model	PCA-6005V-00A1	PCA-6005VE-00A1	PCA-6005E2--0EA1	PCA-6005F-00A1
VGA (AGP 4X): SIS650 chipset integrated	V	V	V	V
LAN: 10/100 Base-T, RTL8139C	X	Single	Dual	Dual
SCSI: Adaptec 7899 U160 SCSI	X	X	X	V
ISA Bus	X	X	X	X

Product warranty

Advantech warrants to you, the original purchaser, that each of its products will be free from defects in materials and workmanship for two years from the date of purchase. This warranty does not apply to any products which have been repaired or altered by persons other than repair personnel authorized by Advantech, or which have been subject to misuse, abuse, accident or improper installation. Advantech assumes no liability under the terms of this warranty as a consequence of such events. If an Advantech product is defective, it will be repaired or replaced at no charge during the warranty period. For out-of-warranty repairs, you will be billed according to the cost of replacement materials, service time and freight. Please consult your dealer for more details. If you think you have a defective product, follow these steps:

1. Collect all the information about the problem encountered. (For example, type of PC, CPU speed, Advantech products used, other hardware and software used, etc.) Note anything abnormal and list any on-screen messages you get when the problem occurs.
2. Call your dealer and describe the problem. Please have your manual, product, and any helpful information readily available.
3. If your product is diagnosed as defective, obtain an RMA (return material authorization) number from your dealer. This allows us to process your return more quickly.
4. Carefully pack the defective product, a fully-completed Repair and Replacement Order Card and a photocopy proof of purchase date (such as your sales receipt) in a shippable container. A product returned without proof of the purchase date is not eligible for warranty service.
5. Write the RMA number visibly on the outside of the package and ship it prepaid to your dealer

Initial Inspection

Before you begin installing your card, please make sure that the following materials have been shipped:

- . 1 PCA-6005 pure PCI single board computer
- . 1 Pentium 4 processor (optional)
- . 1 PCA-6005 startup Manual
- . 1 CD driver utility and manual (in PDF format)
- . 1 FDD cable, P/N: 1701340703
- . 2 UDMA 66/100 HDD cables, P/N: 1701400452
- . 1 printer (parallel port) cable & COM port cable kit, P/N: 1700060305
- . 1 ivory cable for PS/2 keyboard and PS/2 mouse, P/N: 1700060202
- . 1 USB cable (optional), P/N 1700100170
- . 1 single-slot bracket (optional), P/N: 1962159010

If any of these items are missing or damaged, contact your distributor or sales representative immediately. We have carefully inspected the PCA-6005 mechanically and electrically before shipment. It should be free of marks and scratches and in perfect working order upon receipt. As you unpack the PCA-6005, check it for signs of shipping damage. (For example, damaged box, scratches, dents, etc.) If it is damaged or it fails to meet the specifications, notify our service department or your local sales representative immediately. Also notify the carrier. Retain the shipping carton and packing material for inspection by the carrier. After inspection, we will make arrangements to repair or replace the unit

Contents

Chapter 1	General Information	2
1.1	Introduction	2
1.2	Features	3
1.3	General Specifications.....	4
1.3.1	System.....	4
1.3.2	Memory.....	4
1.3.3	Input/Output.....	4
1.3.4	VGA interface.....	4
1.3.5	Ethernet LAN.....	5
1.3.6	Ultra 160 SCSI.....	5
1.3.7	Industrial features	5
1.3.8	Mechanical and environmental specifications.....	5
1.4	Jumpers and Connectors.....	5
	Table 1.1:Jumpers.....	5
	Table 1.2:Connectors.....	6
	Table 1.3:SCSI Daughter board:.....	7
1.5	Board Layout: Jumper and Connector Locations.....	8
1.6	Safety Precautions	10
1.7	Jumper Settings	10
1.7.1	How to set jumpers	10
1.7.2	CMOS clear (J1).....	11
	Table 1.4:CMOS clear (J1).....	11
1.7.3	Watchdog timer output (J2)	11
	Table 1.5:Watchdog timer output (J2).....	11
1.8	System Memory	12
	Table 1.6:DIMM module allocation table	12
1.8.1	Supplementary information about DIMMs.....	12
1.8.2	Memory clock setting	12
1.9	Memory Installation Procedures	13
1.10	Cache Memory	13
1.11	CPU Installation	13
Chapter 2	Connecting Peripherals	16
2.1	Primary (CN1) and Secondary (CN2) IDE Connectors. .	16
2.2	Floppy Drive Connector (CN3).....	17
2.3	Parallel Port (CN4).....	17
2.4	USB Port (CN6).....	18
2.5	VGA Connector (CN7)	18
2.6	10/100Base-T Ethernet Connector (CN8 and CN34) ..	19
2.7	Serial Ports (CN9: COM1; CN10: COM2).....	20
2.8	PS/2 Keyboard and Mouse Connector (CN11 and CN33)	21
2.9	External Keyboard Connector (CN12).....	21

2.10	CPU Fan Connector (CN14)	22
2.11	Front Panel Connectors (CN16, CN17, CN18, CN19, CN21 and CN29).....	22
2.11.1	Keyboard lock and power LED (CN16).....	22
2.11.2	External speaker (CN17)	23
2.11.3	Reset (CN18)	23
2.11.4	HDD LED (CN19).....	23
2.11.5	SM Bus Connector (CN29).....	23
2.11.6	Connecting to SNMP-1000 remote manager.....	24
2.12	ATX Power Control Connectors (CN20 and CN21) ..	24
2.12.1	ATX feature connector (CN20) and soft power switch connector (CN21)	24
2.12.2	Controlling the soft power switch.....	25
2.13	Auxiliary power input (CN46 & ATX1).....	25
Chapter 3	Award BIOS Setup.....	28
3.1	Introduction	28
3.2	Entering Setup	28
	Figure 3.1: Award BIOS Setup initial screen	28
3.3	Standard CMOS Setup	29
3.3.1	CMOS RAM backup	29
3.4	Advanced BIOS Features	30
	Figure 3.2: Advanced BIOS features screen.....	30
3.4.1	Virus Warning.....	30
3.4.2	CPU L1 & L2 Cache.....	30
3.4.3	CPU L2 Cache ECC Checking	30
3.4.4	First/Second/Third/Other Boot Device.....	31
3.4.5	Swap Floppy Drive	31
3.4.6	Boot UP Floppy Seek	31
3.4.7	Boot Up NumLock Status.....	31
3.4.8	Gate A20 Option.....	31
3.4.9	Typematic Rate Setting.....	31
3.4.10	Typematic Rate (Chars/Sec).....	31
3.4.11	Typematic Delay (msec).....	31
3.4.12	Security Option	31
3.4.13	OS Select for DRAM > 64MB	32
3.4.14	Video BIOS Shadow.....	32
3.5	Advanced Chipset Features	33
	Figure 3.3: Advanced chipset features screen	33
3.5.1	Advanced DRAM control 1	34
3.5.2	Prefetch Caching.....	34
3.5.3	System BIOS Cacheable.....	34
3.5.4	Memory Hole.....	35
3.5.5	AGP Aperture Size	35

3.6	Integrated Peripherals.....	35
	Figure 3.4:Integrated peripherals.....	35
3.6.1	SiS OnChip IDE Device.....	36
3.6.2	SiS OnChip PCI Device.....	37
3.6.3	Onboard Super IO Device.....	38
3.6.4	USB controller.....	39
3.6.5	USB Keyboard Support.....	39
3.6.6	USB Mouse Support.....	39
3.6.7	IDE HDD Block Mode.....	39
3.6.8	Onboard Lan Boot Rom.....	39
3.6.9	Init Display First.....	39
3.7	Power Management Setup.....	40
	Figure 3.5:Power management setup screen.....	40
3.7.1	ACPI function.....	40
3.7.2	Power Management.....	40
3.7.3	Video Off Option.....	41
3.7.4	Video Off Method.....	41
3.7.5	MODEM Use IRQ.....	41
3.7.6	Soft-Off by PWRBTN.....	41
3.7.7	Power-Supply Type.....	41
3.7.8	Power State Resume Control.....	42
3.7.9	PM Wake Up Events.....	42
	Figure 3.6:Wake Up Events.....	42
3.8	PnP/PCI Configurations.....	43
3.8.1	Reset Configuration Data.....	43
3.9	PC Health Status.....	44
	Figure 3.8:PC health status screen.....	44
3.9.1	Current CPU Temperature.....	44
3.9.2	Current CPUFAN Speed.....	44
3.9.3	VCORE.....	44
3.10	Load Optimized Defaults.....	44
3.11	Set Password.....	45
3.12	Save & Exit Setup.....	45
3.13	Exit Without Saving.....	45
Chapter 4	AGP SVGA Setup.....	48
4.1	Before You Begin.....	48
4.2	Features.....	48
4.3	VGA Installation.....	49
Chapter 5	LAN Configuration.....	52
5.1	Introduction.....	52
5.2	Features.....	52
5.3	Driver Installation.....	53
5.4	Windows 9X Drivers Setup Procedure.....	54

5.5	Windows NT Drivers Setup Procedure.....	60
5.6	Windows 2000 Drivers Setup Procedure.....	65
Chapter 6	SCSI Setup and Configuration	72
6.1	Introduction.....	72
6.2	Understanding SCSI.....	72
6.3	SCSI IDs.....	73
6.4	Terminating the SCSI Bus.....	74
6.5	Configuring the SCSI interface with SCSISelect.....	75
6.6	Starting SCSISelect.....	77
6.7	Using SCSI Disk Utilities	81
6.8	Installation under Windows NT/Windows 2000.....	82
6.9	Windows 9X Driver setup procedure.....	82
6.10	Windows NT Driver Setup Procedure	87
Appendix A	Programming the watchdog	92
A.1	Programming the watchdog	92
A.1.1	Watchdog timer overview.....	92
A.1.2	Programming the Watchdog Timer	92
A.1.3	Unlock the Super I/O IT8705F	92
A.1.4	Select and program the watchdog timer	92
A.1.5	Select and enable the game port	92
A.1.6	Lock the Super I/O IT8705F.....	93
A.1.7	Resetting the Watchdog Timer	93
A.1.8	List of Registers.....	94
Appendix B	Pin Assignments	102
B.1	IDE Hard Drive Connector (CN1, CN2).....	102
B.2	Floppy Drive Connector (CN3).....	103
B.3	Parallel Port Connector (CN4)	104
B.4	USB Connector (CN6)	105
B.5	VGA Connector (CN7)	106
B.6	Keyboard and Mouse Connector CN11).....	107
B.7	External Keyboard Connector (CN12).....	107
B.8	IR Connector (CN13).....	108
B.9	CPU Fan Power Connector (CN14).....	108
B.10	Power LED (CN16).....	109
B.11	External Speaker Connector (CN17).....	109
B.12	Reset Connector (CN18).....	110
B.13	HDD LED Connector (CN19).....	110
B.14	ATX Feature Connector (CN20).....	111
B.15	ATX Soft Power Switch (CN21)	111
B.16	SM Bus Connector (CN29).....	112
B.17	System I/O Ports.....	112

B.18	DMA Channel Assignments.....	114
B.19	Interrupt Assignments	114
B.20	1st MB Memory Map.....	115
B.21	PCI Bus Map	115

General Information

This chapter gives background information on the PCA-6005. It then shows you how to configure the card to match your application and prepare it for installation into your PC.

Sections include:

- Introduction
- Features
- Specifications
- Board Layout
- Jumpers and Connectors
- Safety Precautions
- Jumper Settings
- System Memory
- Memory Installation Procedures
- Cache Memory
- CPU Installation

Chapter 1 General Information

1.1 Introduction

The PCA-6005 Series all-in-one industrial grade single board computer is a high performance and full-featured computing engine. It meets most of the requirements of industrial applications.

The PCA-6005 supports Intel's Pentium 4 and Socket 478 Celeron processor. The CPU provides 256/512 KB on-CPU L2 cache, featuring Intel's NetBurst. micro-architecture and is capable of delivering maximum computing power. It has two PCI EIDE interfaces (for up to four devices) and a floppy disk drive interface (for up to two devices). Other features include two RS-232 serial ports (16C550 UARTs with 16-byte FIFO or compatible), one enhanced parallel port (supports EPP/ECP) and two USB (Universal Serial Bus) ports. The PCI enhanced IDE controller supports Ultra DMA/33/66/100 providing data transfer rates of 33/66/100 MB/sec. System BIOS supports boot-up from an IDE CD-ROM, SCSI CD-ROM, LS-120, IDE HDD, SCSI HDD, ZIP-100, LAN, and FDD.

A backup of CMOS data is stored in the Flash memory, which protects data even after a battery failure. Also included is a 256-level watchdog timer, which resets the CPU or if a program cannot be executed normally. This enables reliable operation in unattended environments.

The PCA-6005 Series offers several impressive industrial features such as chipset built-in VGA (AGP) interface, dual 10/100Base-T networking controller, dual channel Ultra 160 SCSI, and two 184-pin DIMM slots for a total of 2 GB DDR SDRAM memory. The remote management interface enables the PCA-6005 to be managed through Ethernet when it is connected to the SNMP-1000 Remote HTTP/SNMP System Manager.

- NOTE:**
1. *The PCA-6005 does not support ISA bus.*
 2. *Some of the features mentioned above are not available with all models. For more information about the specifications of a particular model, see Section 1.3: Specifications.*

1.2 Features

1. **Onboard hardware monitoring:** System healthy status including CPU fan, CPU temperature and system voltages levels are monitored to ensure stable operation. proper system configuration and management. A remote monitoring interface is reserved for remote management through Ethernet by using Advantech's SNMP-1000 system management module.
2. **ATX soft power switch:** Through the BIOS, the power button can be defined as the "Standby" (aka "Suspend" or "Sleep") button or as the "Soft-Off" button. Regardless of the setting, pushing the power button for more than 4 seconds will enter the Soft-Off mode.
3. **Power-on by modem (requires modem):** This allows a computer to be turned on remotely through an internal or external modem. Users can thus access information on their computers from anywhere in the world.
4. **Power-on by LAN:** This allows you to remotely power up your system through your network by sending a wake-up frame or signal. With this feature, you can remotely upload/ download data to/ from systems during off-peak hours.
5. **CMOS RAM backup:** When BIOS CMOS setup has been completed, data in the CMOS RAM is automatically backed up to the Flash ROM. This is particularly useful in industrial environments which may cause soft errors. Upon such an error, BIOS will check the data and automatically restore the original data for rebooting.

1.3 General Specifications

1.3.1 System

- **CPU:** Intel socket 478 Celeron® 1.7 GHz and above, Pentium® 4 1.8 GHz and above, FSB 400/533 MHz
- **BIOS:** Award Flash BIOS, 2 Mb
- **System Chipset:** SiS 650/651
- **Enhanced IDE hard disk drive interface:** Supports up to four IDE large hard disk drives or other enhanced IDE devices. Supports PIO mode 4 (16.67 MB/s data transfer rate) and Ultra DMA/33/66/100 (33/66/100 MB/s data transfer rate). BIOS enabled/disabled
- **Floppy disk drive interface:** Supports up to two floppy disk drives, 5" (360 KB and 1.2 MB) and/or 3¼" (720 KB, 1.44 MB, and 2.88 MB). BIOS enabled/disabled

1.3.2 Memory

- **RAM:** Up to 2 GB in two available 184-pin DIMM sockets. Supports PC-200/ PC-266-compliant DDR SDRAM
- No ECC support

1.3.3 Input/Output

- **Bus interface:** PCI bus only, mechanically compliant with PICMG
- **Enhanced parallel port:** Configurable to LPT1, LPT2, LPT3, or disabled. Standard DB-25 female connector provided. Supports EPP/ECP
- **Serial ports:** Two RS-232 ports with 16C550 UARTs (or compatible) with 16-byte FIFO buffer. Supports speeds up to 115.2 Kbps. Ports can be individually configured to COM1, COM2 or disabled
- **Keyboard and PS/2 mouse connector:** A 6-pin mini-DIN connector is located on the mounting bracket for easy connection to a keyboard or PS/2 mouse. An onboard keyboard pin header connector is also available
- **ISA bus:** No ISA bus support

1.3.4 VGA interface

- **Controller:** SiS 650/651 chipset integrated, AGP 4X
- **Display memory:** Share system memory up to 64 MB, BIOS selectable
- Resolution up to 2048x1536 16M colors

1.3.5 Ethernet LAN

- Supports dual 10/100Base-T Ethernet networking
- **Chipset:** Realtek 8139C

1.3.6 Ultra 160 SCSI

- Provides dual channel Ultra 160 SCSI interface
- Chipset: Adaptec AIC7899

1.3.7 Industrial features

- **Watchdog timer:** Can generate a system reset or IRQ11. The watchdog timer is programmable, with each unit equal to one second or one minute (255 levels). You can find programming detail in Appendix A.

1.3.8 Mechanical and environmental specifications

- **Operating temperature:** 0 ~ 60° C (32 ~ 140° F), depending on CPU
- **Storage temperature:** -20 ~ 70° C (-4 ~ 158°F)
- **Humidity:** 20 ~ 95% non-condensing
- **Power supply voltage:** ±5 V, ±12 V
- **Power consumption:** +5 V @ 2.3 A, +12V @ 3.3 A (typical, with Pentium 4 1.6 GHz and 512 MB DDR266 SDRAM)
- **Board size:** 338 x 122 mm (13.3" x 4.8")
- **Board weight:** 0.6 kg (1.2 lb)

1.4 Jumpers and Connectors

Connectors on the PCA-6005 board link it to external devices such as hard disk drives and a keyboard. In addition, the board has a number of jumpers used to configure your system for your application. The tables below list the function of each of the board jumpers and connectors. Later sections in this chapter give instructions on setting jumpers. Chapter 2 gives instructions for connecting external devices to your card.

Table 1.1: Jumpers

Label	Function
J1	CMOS clear
J2	Watchdog timer output

Table 1.2: Connectors

Label	Function
CN1	Primary IDE connector
CN2	Secondary IDE connector
CN3	Floppy drive connector
CN4	Parallel port
CN6	USB port
CN7	VGA connector
CN8	10/100Base-T Ethernet connector
CN9	Serial port: COM1
CN10	Serial port: COM2
CN11	PS/2 keyboard and mouse connector
CN12	External keyboard connector
CN13	Infrared (IR) connector
CN14	CPU fan connector
CN16	Power LED
CN17	External speaker
CN18	Reset connector
CN19	HDD LED connector
CN20	ATX feature connector
CN21	ATX soft power switch
CN27	Extension I/O board connector
CN28	Extension I/O board connector
CN29	External SM bus connector
CN30	External PCI extension connector
CN33	PS/2 mouse connector
CN34	10/100Base-T Ethernet connector 2
CN43	AC-97 audio extension interface
CN46	Auxiliary power input
ATX1	ATX12V auxiliary power input

Table 1.3: SCSI Daughter board:

CN50	68-pin U160 SCSI connector
CN51	68-pin U 160 wide SCSI Connector
CN52	50-pin Ultra Wide SCSI Connector

1.5 Board Layout: Jumper and Connector Locations

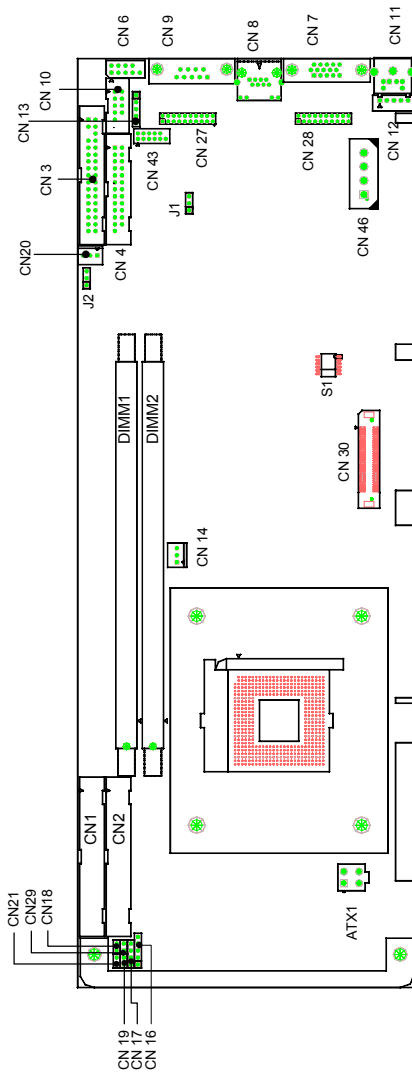

Figure 1.1: Board Layout: Jumper and Connector Locations

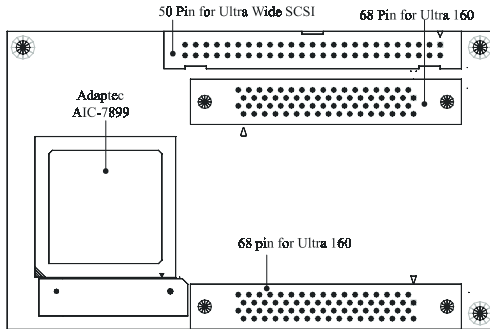

Figure 1.2: SCSI daughter board layout

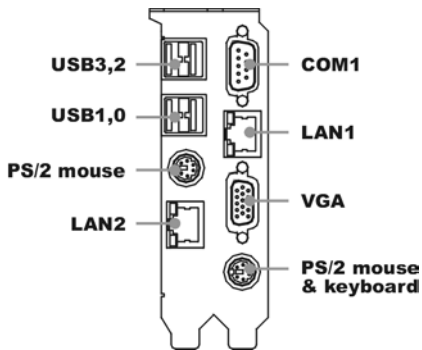

Figure 1.3: I/O connectors on bracket

1.6 Safety Precautions

Warning! Always completely disconnect the power cord from your chassis whenever you work with the hardware. Do not make connections while the power is on. Sensitive electronic components can be damaged by sudden power surges. Only experienced electronics personnel should open the PC chassis.

Caution! Always ground yourself to remove any static charge before touching the CPU card. Modern electronic devices are very sensitive to static electric charges. As a safety precaution, use a grounding wrist strap at all times. Place all electronic components in a static-dissipative surface or static-shielded bag when they are not in the chassis.

1.7 Jumper Settings

This section provides instructions on how to configure your card by setting jumpers. It also includes the card's default settings and your options for each jumper.

1.7.1 How to set jumpers

You configure your card to match the needs of your application by setting jumpers. A jumper is a metal bridge that closes an electrical circuit. It consists of two metal pins and a small metal clip (often protected by a plastic cover) that slides over the pins to connect them. To “close” (or turn ON) a jumper, you connect the pins with the clip. To “open” (or turn OFF) a jumper, you remove the clip. Sometimes a jumper consists of a set of three pins, labeled 1, 2, and 3. In this case you connect either pins 1 and 2, or 2 and 3.

A pair of needle-nose pliers may be useful when setting jumpers.

1.7.2 CMOS clear (J1)

The PCA-6005 CPU card contains a jumper that can erase CMOS data and reset the system BIOS information. Normally this jumper should be set with pins 1-2 closed. If you want to reset the CMOS data, set J1 to 2-3 closed for just a few seconds, and then move the jumper back to 1-2 closed. This procedure will reset the CMOS to its default setting.

Table 1.4: CMOS clear (J1)

Function	Jumper Setting
* Keep CMOS data	1-2 closed
Clear CMOS data	2-3 closed

* default setting

1.7.3 Watchdog timer output (J2)

The PCA-6005 contains a watchdog timer that will reset in case the software fails to reset the watchdog timer. The J2 jumper settings control the outcome of what the computer will do in the event the watchdog timer is tripped.

Table 1.5: Watchdog timer output (J2)

	Jumper Setting	Function
IRQ11	1-2 closed	No Function
	2-3 closed	* Reset

* default setting

1.8 System Memory

The PCA-6005 has two sockets for 184-pin dual inline memory modules (DIMMs). All these sockets use 2.5 V unbuffered double data rate synchronous DRAMs (DDR SDRAM). are available in capacities of 128, 256, 512 and 1024 MB. The sockets can be filled in any combination with DIMMs of any size, giving a total memory size between 128 MB and 2 GB. Use the following table to calculate the total DRAM memory within your computer:

Table 1.6: DIMM module allocation table

Socket Number	184-pin DIMM memory
1	(128, 256, 512 or 1024 MB)
2	(128, 256, 512 or 1024 MB)

1.8.1 Supplementary information about DIMMs

Your PCA-6005 can accept DDR SDRAM memory chips without parity. Also note:

- The PCA-6005 accepts PC-1600 (DDR200) or PC-2100 (DDR266) DDR SDRAM, which can provide twice the performance than the PC-133 SDRAM. The 168-pin SDRAM cannot be used.
- The PCA-6005 does not support ECC (error checking and correction). Memory modules with 9 SDRAM chips/side support ECC; modules with 8 chips/side do not support ECC.

1.8.2 Memory clock setting

The S1 dip switch is used to set the memory clock speed. If you are using 200 MHz DDR module, set S1 to OFF. If you are using 266 MHz DDR module, set S1 to ON. S0 must be set at ON all the time.

1.9 Memory Installation Procedures

To install DIMMs, first make sure the two handles of the DIMM socket are in the "open" position. i.e. The handles lean outward. Slowly slide the DIMM module along the plastic guides on both ends of the socket. Then press the DIMM module right down into the socket, until you hear a click. This is when the two handles have automatically locked the memory module into the correct position of the DIMM socket. To remove the memory module, just push both handles outward, and the memory module will be ejected by the mechanism in the socket.

1.10 Cache Memory

Since the second level (L2) cache has been embedded into the Intel® Pentium 4/Celeron processor, you do not have to take care of either SRAM chips or SRAM modules. The built-in second level cache in the processor yields much higher performance than the external cache memories. The cache size in the Intel® Pentium 4 processor is 256 KB or 512 KB, for Celeron® processor is 256 KB.

1.11 CPU Installation

The CPU on the board must have a fan or heat sink attached, to prevent overheating.

Warning: Without a fan or heat sink, the CPU will over-heat and cause damage to both the CPU and the motherboard. To install a CPU, first turn off your system and remove its cover. Locate the processor socket 478.

1. Make sure the socket 478 lever is in the upright position. To raise the lever, pull it out to the side a little and raise it as far as it will go.
2. Place the CPU in the empty socket. Follow the instructions that came with the CPU. If you have no instructions, complete the following procedure. Carefully align the CPU so it is parallel to the socket and the notches on the corners of the CPU correspond with the notches on the inside of the socket. Gently slide the CPU in. It should insert easily. If it does not insert easily, pull the lever up a little bit more.

1. Press the lever down. The plate will slide forward. You will feel some resistance as the pressure starts to secure the CPU in the socket. This is normal and will not damage the CPU. When the CPU is installed, the lever should snap into place at the side of the socket.

Note: To remove a CPU, pull the lever out to the side a little and raise it as far as it will go. Lift out the CPU.

Connecting Peripherals

This chapter tells how to connect peripherals, switches and indicators to the PCA-6005 board. You can access most of the connectors from the top of the board while it is installed in the chassis. If you have a number of cards installed, or your chassis is very tight, you may need to partially remove the card to make all the connections.

Chapter 2 Connecting Peripherals

2.1 Primary (CN1) and Secondary (CN2) IDE Connectors.

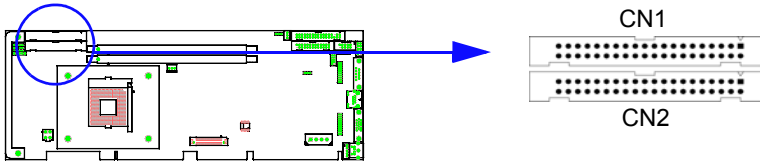

You can attach up to four IDE (Integrated Device Electronics) drives to the IDE connectors. The primary (CN1) and secondary (CN2) connectors can each accommodate two drives.

Wire number 1 on the cable is red or blue and the other wires are gray. Connect one end to connector CN1 or CN2 on the CPU card. Make sure that the red/blue wire corresponds to pin 1 on the connector (in the upper right hand corner). See Chapter 1 for help finding the connector.

Unlike floppy drives, IDE hard drives can connect in either position on the cable. If you install two drives to a single connector, you will need to set one as the master and one as the slave. You do this by setting the jumpers on the drives. If you use just one drive per connector, you should set each drive as the master. See the documentation that came with your drive for more information.

Connect the first hard drive to the other end of the cable. Wire 1 on the cable should also connect to pin 1 on the hard drive connector, which is labeled on the drive circuit board. Check the documentation that came with the drive for more information.

Connect the second hard drive to the remaining connector (CN2 or CN1), in the same way as described above.

2.2 Floppy Drive Connector (CN3)

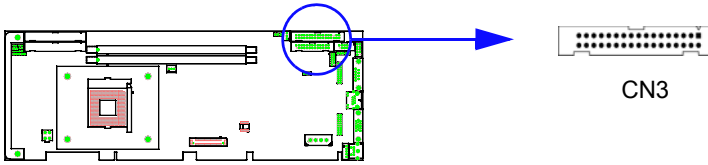

You can attach up to two floppy disk drives to the onboard connector. You can use any combination of 5.25" (360 KB / 1.2 MB) and/or 3.5" (720 KB / 1.44/2.88 MB) drives. The card comes with a 34-pin daisy-chain drive connector cable. On one end of the cable is a 34-pin flat-cable connector. On the other end are two floppy disk drive connectors. The one on the end (after the twist in the cable) connects to the A: floppy drive. The one in the middle connects to the B: floppy drive.

2.3 Parallel Port (CN4)

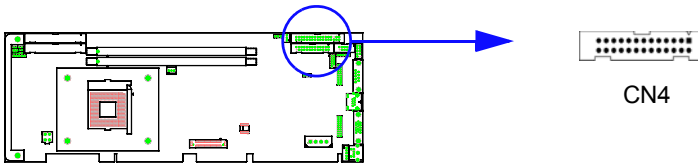

The parallel port is normally used to connect the CPU card to a printer. The onboard parallel port can be accessed through a 26-pin flat-cable connector, CN4. The card comes with an adapter cable which lets you use a traditional DB-25 connector. The cable has a 26-pin connector on one end and a DB-25 connector on the other, mounted on a retaining bracket. The bracket installs at the end of an empty slot in your chassis, giving you access to the connector.

The parallel port is designated as LPT1, and can be disabled or changed to LPT2 or LPT3 in the system BIOS setup.

To install the bracket, find an empty slot in your chassis. Unscrew the plate that covers the end of the slot. Screw in the bracket in place of the

plate. Next, attach the flat-cable connector to CN4 on the CPU card. Wire 1 of the cable is red or blue, and the other wires are gray. Make sure that wire 1 corresponds to pin 1 of CN4. Pin 1 is on the upper right side of CN4

2.4 USB Port (CN6)

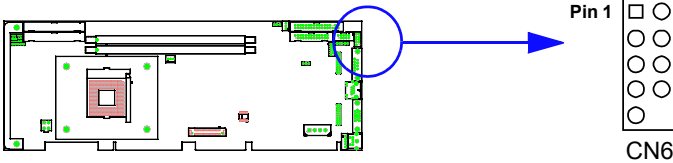

The PCA-6005 provides four USB (Universal Serial Bus) interfaces, which give complete Plug & Play and hot attach/detach for up to 127 external devices. The USB interface complies with USB Specification Rev. 1 and is fuse-protected.

The USB interface is accessed through a 10-pin flat-cable connector, CN6. The adapter cable has a 10-pin connector on one end and two USB connectors on the bracket.

The USB interface can be disabled in the system BIOS setup.

2.5 VGA Connector (CN7)

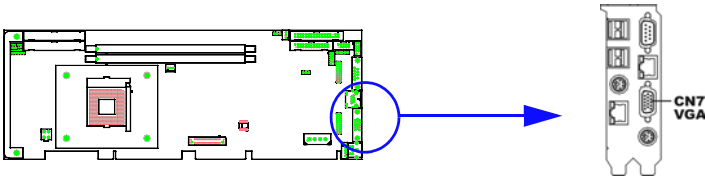

The PCA-6005 includes an AGP SVGA interface that can drive a standard CRT display. CN7 is a standard 15-pin D-SUB connector commonly

used for VGA. Pin assignments for CRT connector CN7 are detailed in Appendix B.

2.6 10/100Base-T Ethernet Connector (CN8 and CN34)

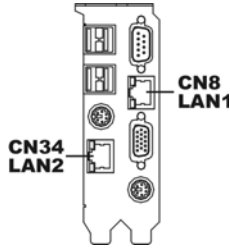

The PCA-6005 is equipped with dual high-performance 32-bit PCI-bus Ethernet interface, which is fully compliant with IEEE 802.3/u 10/100 Mbps CSMA/CD standards. It is supported by all major network operating systems and is 100% Novell NE-2000 compatible. An onboard RJ-45 jack provides convenient 10/100Base-T RJ-45 operation.

2.7 Serial Ports (CN9: COM1; CN10: COM2)

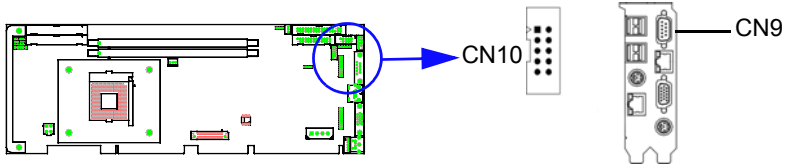

The PCA-6005 offers two serial ports, CN9 as COM1 and CN10 as COM2. These ports can connect to serial devices, such as a mouse or printers, or to a communication network

Table 2.1: Serial port connections (COM1, COM2)

Connector	Ports	Address	Interrupt
CN9	COM1	3F8*, 3E8	IRQ4
CN10	COM2	2F8*, 2E8	IRQ3

* default settings

The IRQ and address ranges for both ports are fixed. However, if you want to disable the port or change these parameters later, you can do this in the system BIOS setup.

Different devices implement the RS-232 standard in different ways. If you are having problems with a serial device, be sure to check the pin assignments for the connector.

2.8 PS/2 Keyboard and Mouse Connector (CN11 and CN33)

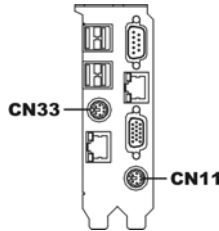

Two 6-pin mini-DIN connectors (CN11 and CN33) on the card mounting bracket provide connection to a PS/2 keyboard and a PS/2 mouse, respectively. CN11 can also be connected to an adapter cable (P/N: 1700060202, available from Advantech) for connecting to both a PS/2 keyboard and a PS/2 mouse.

2.9 External Keyboard Connector (CN12)

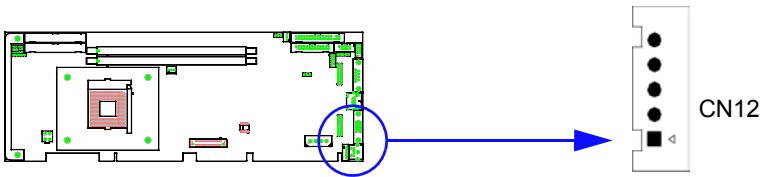

In addition to the PS/2 mouse/keyboard connector on the PCA-6005's rear plate, there is also an extra onboard external keyboard connector. This gives system integrators greater flexibility in designing their systems.

2.10 CPU Fan Connector (CN14)

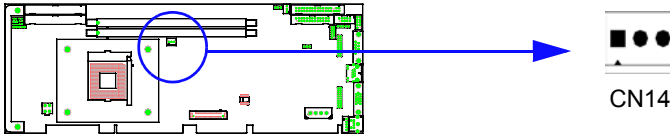

This connector supports a cooling fan with tachometer output.

2.11 Front Panel Connectors (CN16, CN17, CN18, CN19, CN21 and CN29)

There are several external switches to monitor and control the PCA-6005.

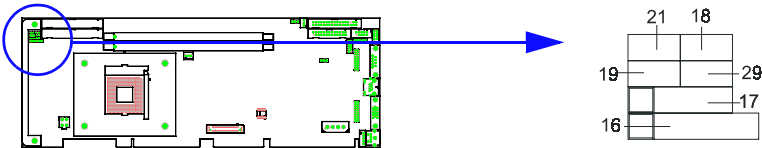

2.11.1 Keyboard lock and power LED (CN16)

CN16 is a 5-pin connector for the power on LED. Refer to Appendix B for detailed information on the pin assignments. If a PS/2 or ATX power supply is used, the system's power LED status will be as indicated below:

Table 2.2: PS/2 or ATX power supply LED status

Power mode	LED (PS/2 power)	LED (ATX power)
System On	On	On
System Suspend	Fast flashes	Fast flashes
System Off	Off	Slow flashes

2.11.2 External speaker (CN17)

CN17 is a 4-pin connector for an external speaker. If there is no external speaker, the PCA-6005 provides an onboard buzzer as an alternative. To enable the buzzer, set pins 3-4 as closed.

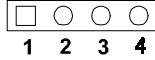

2.11.3 Reset (CN18)

Many computer cases offer the convenience of a reset button. Connect the wire from the reset button.



2.11.4 HDD LED (CN19)

You can connect an LED to connector CN19 to indicate when the HDD is active.



2.11.5 SM Bus Connector (CN29)

This connector is reserved for Advantech's SNMP-1000 HTTP/SNMP Remote System Manager. The SNMP-1000 allows users to monitor the internal voltages, temperature and fans from a remote computer through an Ethernet network.

2.11.6 Connecting to SNMP-1000 remote manager

Use the 6-pin to 8-pin cable to connect the CPU card to SNMP-1000. This cable comes with the SNMP-1000.



2.12 ATX Power Control Connectors (CN20 and CN21)

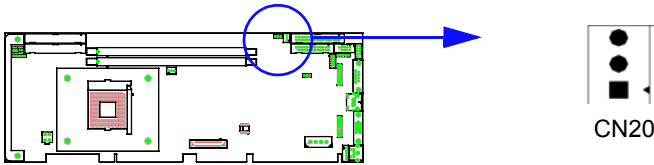

2.12.1 ATX feature connector (CN20) and soft power switch connector (CN21)

The PCA-6005 can support an advanced soft power switch function if an ATX power supply is used. To enable the soft power switch function:

1. Take the specially designed ATX-to-PS/2 power cable out of the accessory bag.
2. Connect the 3-pin plug of the cable to CN20 (ATX feature connector).
3. Connect the power on/off button to CN21. (A momentary type of button should be used.)

Note: If you will not be using an ATX power connector, make sure that pins 2-3 of CN20 are closed.

- Warnings:*
- 1. Make sure that you unplug your power supply when adding or removing expansion cards or other system components. Failure to do so may cause severe damage to both your CPU card and expansion cards.*
 - 2. ATX power supplies may power on if certain motherboard components or connections are touched by metallic objects.*

Important: *Make sure that the ATX power supply can take at least a 720 mA load on the 5 V standby lead (5VSB). If not, you may have difficulty powering on your system and/or supporting the "Wake-on-LAN" function.*

2.12.2 Controlling the soft power switch

Users can also identify the current power mode through the system's power LED (see Section 2.13.1).

2.13 Auxiliary power input (CN46 & ATX1)

To supply adequate 12V power to the CPU card, the PCA-6005 provides two auxiliary power connectors, CN46 and ATX1. CN46 accepts a standard device power connector, and ATX1 accepts 4-pin ATX 12V connector.

Warning: *Either CN31 or ATX1 has to be connected, otherwise the system may be unstable.*

CHAPTER 3

Award BIOS Setup

This chapter describes how to set the card's BIOS configuration data.

Chapter 3 Award BIOS Setup

3.1 Introduction

Award's BIOS ROM has a built-in setup program that allows users to modify the basic system configuration. This type of information is stored in battery-backed memory (CMOS RAM) so that it retains the setup information when the power is turned off.

3.2 Entering Setup

Turn on the computer and check for the “patch code”. If there is a number assigned to the patch code, it means that the BIOS supports your CPU. If there is no number assigned to the patch code, please contact Advantech's applications engineer to obtain an up-to-date patch code file. This will ensure that your CPU's system status is valid. After ensuring that you have a number assigned to the patch code, press to allow you to enter the setup.

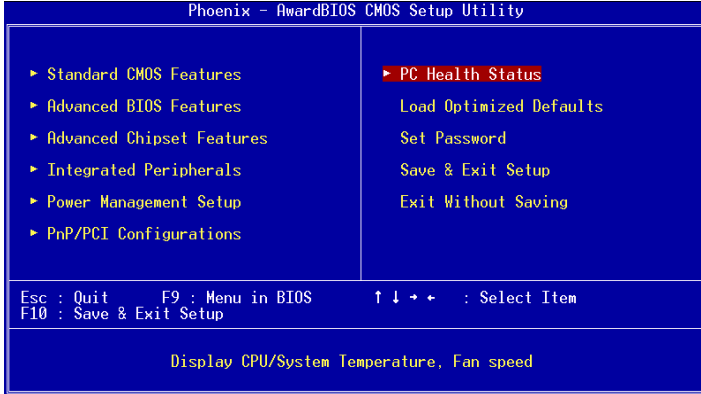
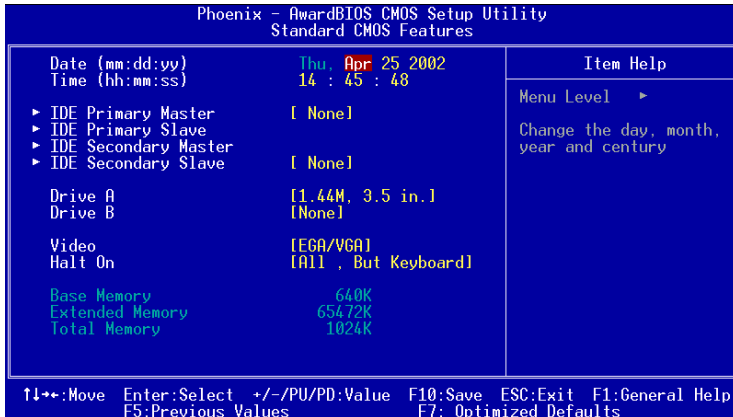

Figure 3.1: Award BIOS Setup initial screen

3.3 Standard CMOS Setup

Choose the “Standard CMOS Features” option from the “Initial Setup Screen” menu, and the screen below will be displayed. This menu allows users to configure system components such as date, time, hard disk drive, floppy drive, display, and memory.



3.3.1 CMOS RAM backup

The CMOS RAM is powered by an onboard button cell battery. When BIOS CMOS Setup has been completed, CMOS RAM data is automatically backed up to Flash ROM. If conditions in a harsh industrial environment cause a soft error, BIOS will recheck the data and automatically restore the original data for booting.

Note: *If you intend to update CMOS RAM data, you have to click on “DEL” within two seconds of the “CMOS checksum error....” display screen message appearing. Then enter the “Setup” screen to modify the data. If the “CMOS checksum error....” message appears again and again, please check to see if you need to replace the battery in your system.*

3.4 Advanced BIOS Features

The “Advanced BIOS Features” screen appears when choosing the “Advanced BIOS Features” item from the “Initial Setup Screen” menu. It allows the user to configure the CPU card according to his particular requirements.

Below are some major items that are provided in the Advanced BIOS Features screen.

A quick booting function is provided for your convenience. Simply enable the Quick Booting item to save yourself valuable time.

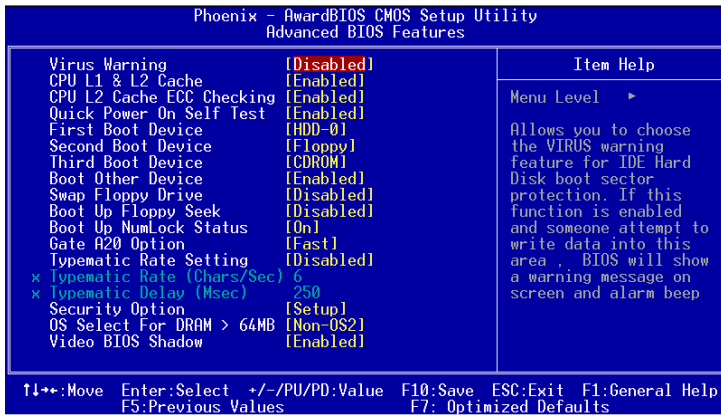

Figure 3.2: Advanced BIOS features screen

3.4.1 Virus Warning

If enabled, a warning message and alarm beep activates if someone attempts to write here. The commands are “Enabled” or “Disabled.”

3.4.2 CPU L1 & L2 Cache

Enabling this feature speeds up memory access. The commands are “Enabled” or “Disabled.”

3.4.3 CPU L2 Cache ECC Checking

Enabling allows CPU L2 cache checking. The commands are “Enabled” or “Disabled.”

3.4.4 First/Second/Third/Other Boot Device

The BIOS tries to load the OS with the devices in the sequence selected. Choices are: Floppy, LS/ZIP, HDD, SCSI, CDROM, LAN, Disabled.

3.4.5 Swap Floppy Drive

Logical name assignments of floppy drives can be swapped if there is more than one floppy drive. The commands are “Enabled” or “Disabled.”

3.4.6 Boot UP Floppy Seek

Selection of the command “Disabled” will speed the boot up. Selection of “Enabled” searches disk drives during boot up.

3.4.7 Boot Up NumLock Status

This feature selects the “power on” state for NumLock. The commands are “Enabled” or “Disabled.”

3.4.8 Gate A20 Option

Normal The A20 signal is controlled by the keyboard controller. Fast (Default) The A20 signal is controlled by the chipset.

3.4.9 Typematic Rate Setting

The typematic rate is the rate key strokes repeat as determined by the keyboard controller. The commands are “Enabled” or “Disabled.” Enabling allows the typematic rate and delay to be selected.

3.4.10 Typematic Rate (Chars/Sec)

BIOS accepts the following input values (characters/second) for typematic rate: 6, 8, 10, 12, 15, 20, 24, 30.

3.4.11 Typematic Delay (msec)

Typematic delay is the time interval between the appearance of two consecutive characters, when holding down a key. The input values for this category are: 250, 500, 750, 1000 (msec).

3.4.12 Security Option

This setting determines whether the system will boot up if the password is denied. Access to Setup is, however, always limited. System The system will not boot, and access to Setup will be denied if the correct password is

not entered at the prompt. Setup The system will boot, but access to Setup will be denied if the correct password is not entered at the prompt.

Note: To disable security, select "PASSWORD SETTING" in the main menu. At this point, you will be asked to enter a password. Simply press <Enter> to disable security. When security is disabled, the system will boot, and you can enter Setup freely.

3.4.13 OS Select for DRAM > 64MB

This setting allows selecting an OS with greater than 64MB of RAM. Commands are "Non-OS2" or "OS2."

3.4.14 Video BIOS Shadow

Enable copies video BIOS to shadow RAM for performance improving. Choices are Enable, Disable.

3.5 Advanced Chipset Features

By choosing the “Advanced Chipset Features” option from the “Initial Setup Screen” menu, the screen below will be displayed. This sample screen contains the manufacturer’s default values for this CPU card, as shown in Figure 3-5: .

Note: DRAM default timings have been carefully chosen and should ONLY be changed if data is being lost. Please first contact technical support

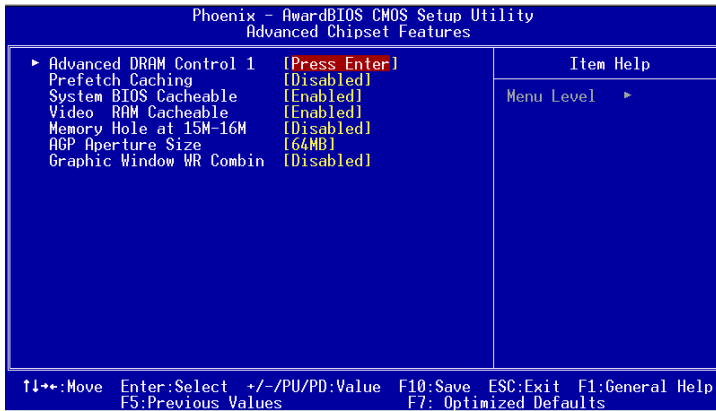
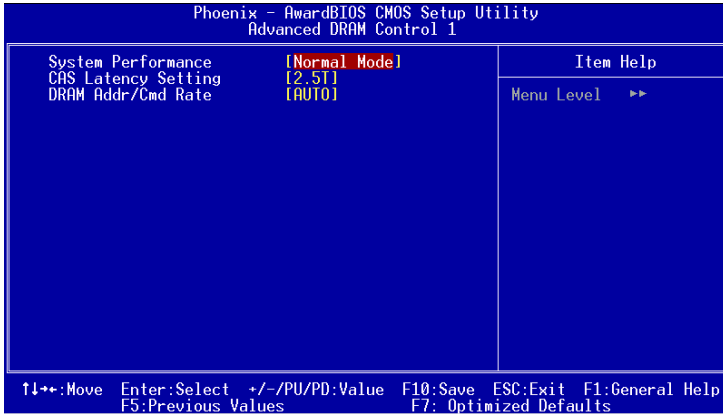

Figure 3.3: Advanced chipset features screen

3.5.1 Advanced DRAM control 1



This item allows you to control the DRAM speed.

3.5.1.1 System performance

This item should be set at "Normal Mode" to ensure system stability.

3.5.1.2 CAS Latency Setting

This item is used to adjust the CAS latency. Default setting is 2.5T.

3.5.1.3 DRAM Addr/Cmd Rate

This item is set at "AUTO". It is not recommended to change the setting.

3.5.2 Prefetch Caching

This item allows to enable/disable the PCI bus prefetch caching. Default is disabled.

3.5.3 System BIOS Cacheable

Selecting Enabled allows caching of the system BIOS ROM at F0000h-FFFFFh, resulting in better system performance. However, if any program writes to this memory area, a system error may result. The choice: Enabled, Disabled.

3.5.4 Memory Hole

In order to improve performance, certain space in memory is reserved for ISA cards. This memory must be mapped into the memory space below 16MB. The Choice: 15M-16M, Disabled.

3.5.5 AGP Aperture Size

Select the size of Accelerated Graphics Port (AGP) aperture. The aperture is a portion of the PCI memory address range dedicated for graphics memory address space. Host cycles that hit the aperture range are forwarded to the AGP without any translation. The Choice: 4M, 8M, 16M, 32M, 65M, 128M, 256M.

3.6 Integrated Peripherals

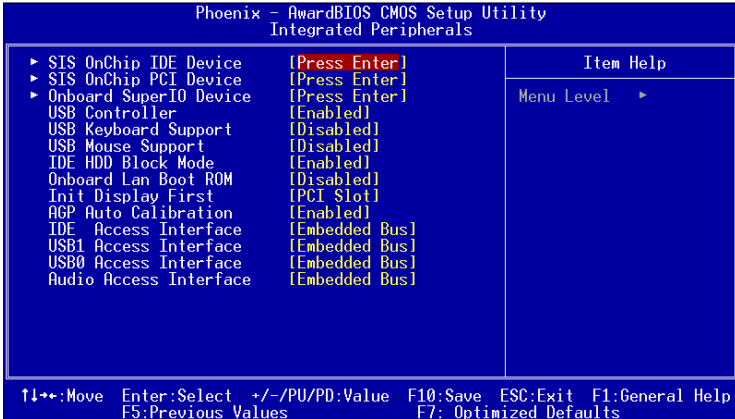
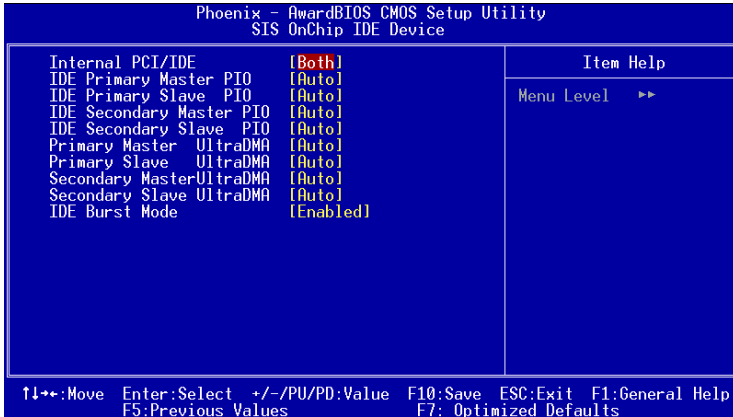

Figure 3.4: Integrated peripherals

3.6.1 SiS OnChip IDE Device

Press Enter to set the internal IDE controller.



3.6.1.1. IDE Primary Master/Slave PIO/UDMA Mode, IDE Secondary Master/Slave PIO/UDMA Mode (Auto) Each channel

(Primary and Secondary) has both a master and a slave, making four IDE devices possible. Because each IDE device may have a different Mode timing (0, 1, 2, 3, 4), it is necessary for these to be independent. The default setting “Auto” will allow autodetection to ensure optimal performance.

3.6.2 SiS OnChip PCI Device

Press Enter to set the on-chip PCI devices.

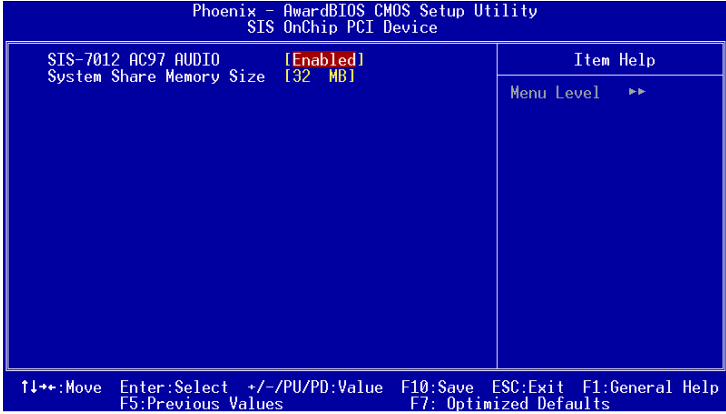

3.6.2.1 SiS-7012 AC-97 Audio

If the AC-97 audio function is required, set this item to Enabled.

3.6.2.2 System Share Memory Size

This item is used to set the shared size of system memory for VGA display. The choices are: 4 MB, 8 MB, 16 MB, 32 MB and 64 MB.

3.6.3 Onboard Super IO Device

Press enter to set up the on board super I/O device.

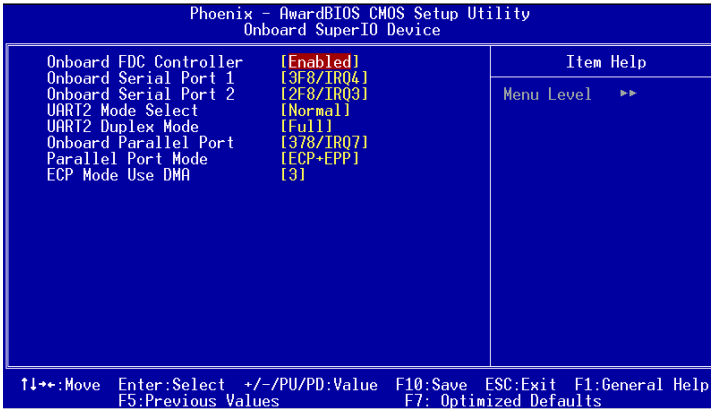

3.6.3.1 Onboard FDC Controller

When enabled, this field allows you to connect your floppy disk drives to the onboard floppy disk drive connector instead of a separate controller card. If you want to use a different controller card to connect the floppy disk drives, set this field to Disabled.

3.6.3.2. Onboard Serial Port 1 (3F8H/IRQ4)

The settings are Auto 3F8/IRQ4, 2F8/IRQ3, 3E8/IRQ4, 2E8/IRQ3, and Disabled for the on-board serial connector.

3.6.3.3. Onboard Serial Port 2 (2F8H/IRQ3)

The settings are Auto 3F8/IRQ4, 2F8/IRQ3, 3E8/IRQ4, 2E8/IRQ3, and Disabled for the on-board serial connector.

3.6.3.4. UART 2 Mode Select

This item allows you to select UART mode.

3.6.3.5. Onboard Parallel Port (378H/IRQ7)

This field sets the address of the on-board parallel port connector. You can select either 3BC/IRQ7, 378/IRQ7, 278/IRQ5 or Disabled. If you install an I/O card with a parallel port, make sure there is no conflict in the address assignments. The CPU card can support up to three parallel ports, as long as there are no conflicts for each port.

3.6.3.6 Onboard Parallel Port Mode (ECP + EPP)

This field allows you to set the operation mode of the parallel port. The setting “Normal” allows normal speed operation, but in one direction only. “EPP” allows bidirectional parallel port operation at maximum speed. “ECP” allows the parallel port to operate in bidirectional mode and at a speed faster than the maximum data transfer rate. “ECP + EPP” allows normal speed operation in a two-way mode.

3.6.3.7. ECP Mode Use DMA

This selection is available only if you select “ECP” or “ECP + EPP” in the Parallel Port Mode field. In ECP Mode Use DMA, you can select DMA channel 1, DMA channel 3, or Disable. Leave this field on the default setting.

3.6.4 USB controller

This should be enabled if your system has a USB installed on the system board and you want to use it. Even when so equipped, if you add a higher performance controller, you will need to disable this feature. The choice: Enabled, Disabled.

3.6.5 USB Keyboard Support

Select Enabled if your system contains a Universal Serial Bus (USB) controller and you have a USB keyboard. The choice: Enabled, Disabled.

3.6.6 USB Mouse Support

Select Enabled if your system contains a Universal Serial Bus (USB) controller and you have a USB mouse. The choice: Enabled, Disabled.

3.6.7 IDE HDD Block Mode

Block mode is also called block transfer, multiple commands, or multiple sector read/write. If your IDE hard drive supports block mode (most new drives do), select Enabled for automatic detection of the optimal number of block read/writes per sector the drive can support. The choice: Enabled, Disabled

3.6.8 Onboard Lan Boot Rom

The LAN boot ROM for boot on LAN function can be enabled or disabled.

3.6.9 Init Display First

This item allows you to choose which one to activate first, PCI Slot or AGP. The choices: PCI Slot, AGP.

3.7 Power Management Setup

The power management setup controls the CPU card's "green" features to save power. The following screen shows the manufacturer's defaults:

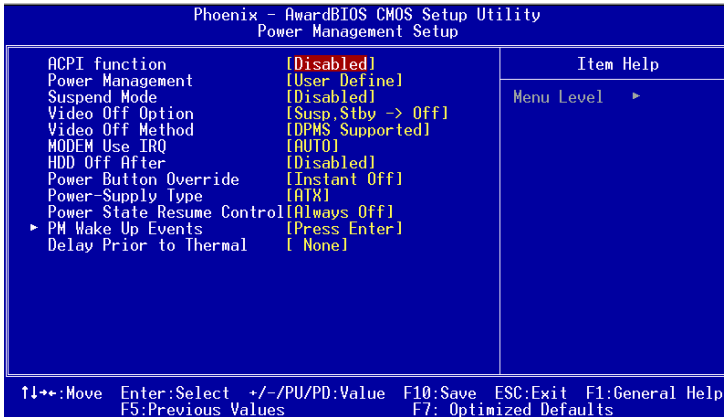

Figure 3.5: Power management setup screen

3.7.1 ACPI function

This item allows you to enable/disable the Advanced Configuration and Power Management (ACPI). The choice: Enabled, Disabled.

3.7.2 Power Management

This category allows you to select the type (or degree) of power saving and is directly related to the following modes:

1. HDD Power Down
2. Doze Mode
3. Suspend Mode

There are four selections for Power Management, three of which have fixed mode settings.

Disable (Default)	No power management. Disables all four modes.
Min. Power Saving	Minimum power management. Doze Mode=1 hr. Standby Mode=1 hr., Suspend Mode=1 hr., and HDD Power Down=15 min.
Max Power Saving	Maximum power management. Doze Mode=1 min., Standby Mode=1 min., Suspend Mode=1 min., and HDD Power Down=1 min.
User Defined	Allows you to set each mode individually. When not disabled, each of the ranges are from 1 min. to 1 hr. except for HDD Power Down which ranges from 1 min. to 15 min. and disable.

3.7.3 Video Off Option

When enabled, this feature allows the VGA adapter to operate in a power saving mode.

Always On	Monitor will remain on during power saving modes.
Suspend N--->Off	Monitor blanked when the systems enters the Suspend mode.
Susp, Stby--->Off	Monitor blanked when the system enters either Suspend or Standby modes.
All Modes N>Off	Monitor blanked when the system enters any power saving mode.

3.7.4 Video Off Method

This determines the manner in which the monitor is blanked.

V/H SYNC+Blank	This selection will cause the system to turn off the vertical and horizontal synchronization ports and write blanks to the video buffer.
Blank Screen	This option only writes blanks to the video buffer
DPMS	Select this option if your monitor supports the Display Power Management Signaling (DPMS) standard of the Video Electronics Standards to select video power management values.

3.7.5 MODEM Use IRQ

This determines the IRQ in which the MODEM can use. The choices: 3, 4, 5, 7, 9, 10, 11, NA.

3.7.6 Soft-Off by PWRBTN

If you choose “Instant-Off”, then pushing the ATX soft power switch button once will switch the system to “system off” power mode. You can choose “Delay 4 sec.” If you do so, then pushing the button for more than 4 seconds will turn off the system, whereas pushing the button momentarily (for less than 4 seconds) will switch the system to “suspend” mode.

3.7.7 Power-Supply Type

Choice: AT, ATX

3.7.8 Power State Resume Control

This field lets you to determine the state that your computer returns after a power failure. If sets to Off, the PC will not boot after a power failure. If sets to On, the PC will restart after a power failure. If sets to Auto, the PC will go back to the previous state before a power failure occurred. For instance, if the PC is power-on when power system fails, the PC will restart when power system is working again. If the PC is power-ff when power system fails, the PC will not boot when power system is working again. The Choice: Off, On, Auto.

3.7.9 PM Wake Up Events

Users can enable some system events to wake up the system.

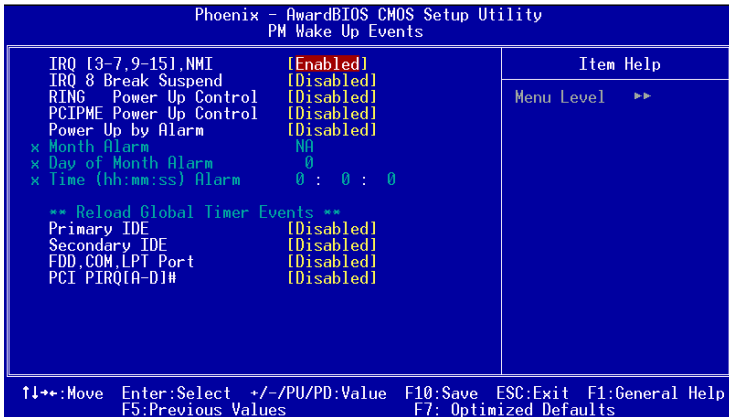

Figure 3.6: Wake Up Events

3.8 PnP/PCI Configurations

3.8.1 Reset Configuration Data.

Note: This is left "Disabled." Select "Enabled" to reset Extended System Configuration Data (ECSD) if you have installed a new add-on and your OS won't boot and you need to reconfigure

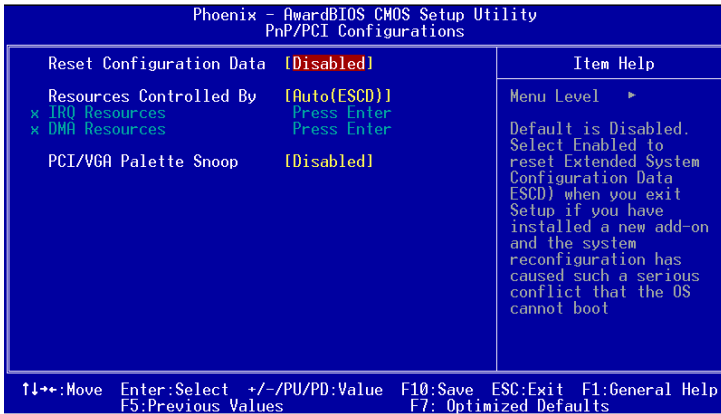

Figure 3.7: PnP/PCI configurations screen

3.9 PC Health Status

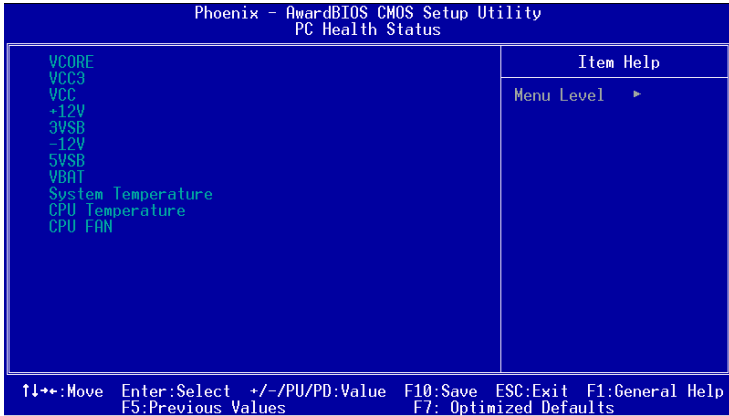

Figure 3.8: PC health status screen

3.9.1 Current CPU Temperature

This shows you the current CPU1 temperature.

3.9.2 Current CPUFAN Speed

This shows you the current CPUFAN speed.

3.9.3 VCORE

This shows CPU1 core voltage. 3.10.4 +2.5/ +3.3V/ + 5V/ +12V. This shows you the voltage of +2.5/ +3.3V/ + 5V/ +12V

3.10 Load Optimized Defaults

“LOAD SETUP DEFAULTS” loads the values required by the system for maximum performance.

3.11 Set Password

To change the password:

1. Choose the “Set Password” option from the “Initial Setup Screen” menu and press <Enter>. The screen will display the following message:

Enter Password:

Press <Enter>.

2. If the CMOS is good or if this option has been used to change the default password, the user is asked for the password stored in the CMOS. The screen will display the following message:

Confirm Password:

Enter the current password and press <Enter>.

3. After pressing <Enter> (ROM password) or the current password (user-defined), you can change the password stored in the CMOS. The password must be no longer than eight (8) characters. Remember, to enable the password setting feature, you must first select either “Setup” or “System” from the “Advanced BIOS Features” menu.

3.12 Save & Exit Setup

If you select this and press <Enter>, the values entered in the setup utilities will be recorded in the CMOS memory of the chipset. The microprocessor will check this every time you turn your system on and compare this to what it finds as it checks the system. This record is required for the system to operate.

3.13 Exit Without Saving

Selecting this option and pressing <Enter> lets you exit the setup program without recording any new values or changing old ones.

AGP SVGA Setup

The PCA-6005 features an integrated high performance VGA interface. This chapter provides instructions for installing and operating the software drivers on the display driver CD included in your package.

Chapter 4 AGP SVGA Setup

4.1 Before You Begin

To facilitate the installation of the enhanced display device drivers and utility software, you should read the instructions in this chapter carefully before you attempt installation. The enhanced display drivers for the PCA-6005 board are located on the software installation CD. You must install the drivers and utility software by using the supplied SETUP program for DOS drivers.

Note: The files on the software installation CD are compressed. Do not attempt to install the drivers by copying the files manually. You must use the supplied SETUP program to install the drivers.

Before you begin, it is important to note that most display drivers need to have the relevant software application already installed in the system prior to installing the enhanced display drivers. In addition, many of the installation procedures assume that you are familiar with both the relevant software applications and operating system commands. Review the relevant operating system commands and the pertinent sections of your application software's user's manual before performing the installation.

4.2 Features

- Chipset integrated 2D/3D graphics accelerator
- 2 pixel rendering pipelines and 4 texture 3D graphic engine
- Ultra-AGP II. technology delivering AGP8X equivalent 2GB/s bandwidth
- Advanced HW acceleration for DVD playback
- Shared memory size up to 64MB
- Integrated 333 MHz RAMDAC supports resolution up to 2048x1536 16M colors

4.3 VGA Installation

First, insert CD drive. Then follow the Icons for your PCA Series model number.

Click on the right driver for the auto-installation.

The installation program will guide you through the whole installation process. Follow the instruction when necessary.



LAN Configuration

The PCA-6005 features an onboard LAN interface. This chapter gives detailed information on Ethernet configuration. It shows you how to configure the card to match your application requirements.

Chapter 5 LAN Configuration

5.1 Introduction

The PCA-6005 features an optional single/dual 32-bit 10/100 Mbps Ethernet network interface. This interface supports bus mastering architecture and auto-negotiation features. Therefore standard twisted-pair cabling with RJ-45 connectors for both 10 Mbps and 100 Mbps connections can be used. Extensive driver support for commonly-used network systems is also provided.

5.2 Features

- Realtek RTL8139C Ethernet LAN controller (fully integrated 10Base-T/100Base-TX)
- Supports Wake-on-LAN remote control function
- Supports up to 128 K bytes Boot ROM
- PCI Bus Master complies with PCI Rev. 2.2
- MAC & PHY (10/100 Mbps) interfaces
- Complies to IEEE 802.3X 10Base-T and IEEE 802.3u 100Base-T interfaces
- 3.3 V power supply with 5 V tolerant I/Os
- Single RJ-45 connector gives auto-detection of 10 Mbps or 100 Mbps network data transfer rates and connected cable types
- Enhancements on ACPI, PCI power management
- Compliant to PC99 standard

5.3 Driver Installation

The PCA-6005's onboard Ethernet interface supports all major network operating systems.

The BIOS automatically detects the LAN while booting, and assigns an IRQ level and I/O address. No jumpers or switches are required for user configuration.

The drivers and installation instructions are located in the following directories of the utility CD:

- Dos: Drivers for DOS platforms
- Info: Installation instructions
- Nwserver: Drivers for Novell NetWare
- Wfw: Drivers for Windows 3.11 for Workgroups

Please refer to the text files in the Info directory for detailed information about installing the drivers.

Note: Operating system vendors may post driver updates on their websites. Please visit the websites of OS vendors to download updated drivers.

5.4 Windows 9X Drivers Setup Procedure

Note 1: If you are using Windows 98SE, your system will find the LAN device "PCI Ethernet Controller". You must first remove this device from your system, and then restart your computer. Then you will be ready to install the correct driver by following the procedure below.

Note 2: The CD-ROM drive is designated as "D" throughout this section.

1. In the "Windows" screen, click on "Start" and select "Settings". Then click on the "Control Panel" icon to select "System".



2. In the "System Properties" window, select the "Device Manager" tab. Select "View devices by type", and navigate to: Computer\Other devices\PCI Ethernet Controller. Highlight "PCI Ethernet Controller" and click on "Properties".

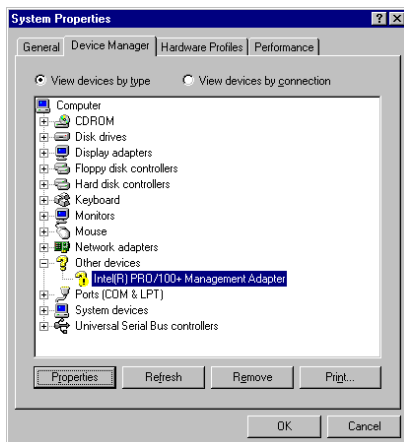

3. In the "PCI Ethernet Controller Properties" window, select the "Driver" tab. Then click on "Update Driver...".

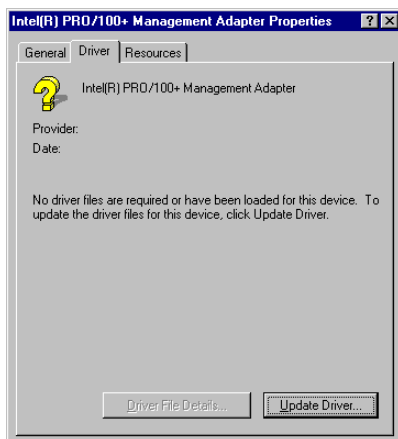

4. In the "Update Device Driver Wizard" window, click on "Next".



5. Click "Next".



6. In the following "Update Device Driver Wizard" window, select "Specify a location:". Type in: "D:\Drv_LAN\RTL8139C\WIN98". Then click on "Next".



7. In the following "Update Device Driver Wizard" window, select "The updated driver ...". Then click on "Next".



8. In the following "Update Device Driver Wizard" window, click on "Next".

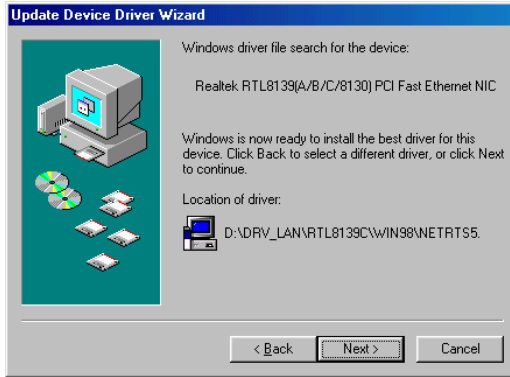

9. When the "Insert Disk" window appears, insert the utility CD into the CD-ROM drive. Then click on "OK".

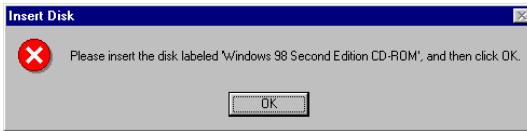

10. When the "Update Device Driver Wizard" window shows, click on finish.

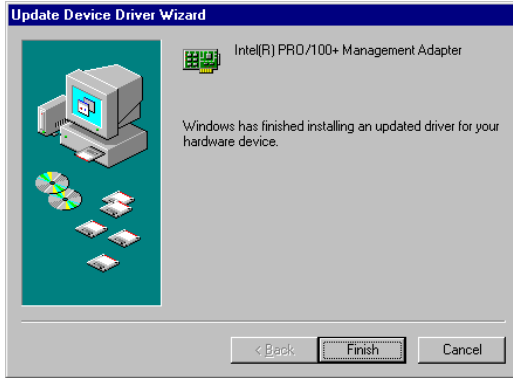

11. In the "System Settings change" window, select click on "Yes".



5.5 Windows NT Drivers Setup Procedure

Note: The CD-ROM drive is designated as "E" throughout this section.

1. In the "Windows NT" screen, click on "Start" and select "Settings". Then click on the "Control Panel" icon to select "Network".

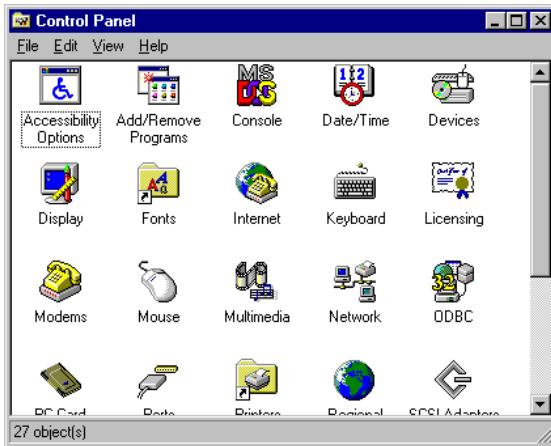

- In the "Network" window, select the "Adapters" tab. Then click on "Add...".

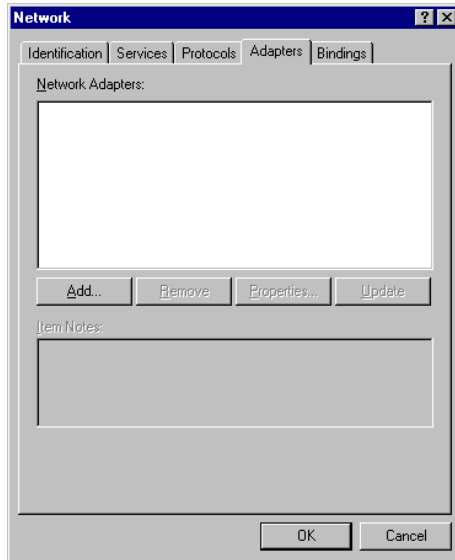

- In the "Select Network Adapter" window, click on "Have Disk...".

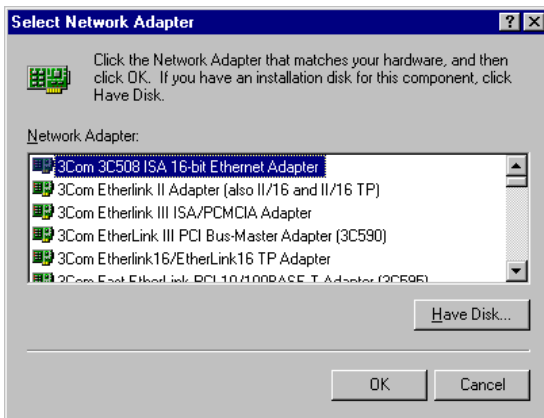

- When the "Insert Disk" window appears, insert the utility CD into the CD-ROM drive. The correct file path is; D:\Drv_LAN\RTL8139C\WINNT4. When you have the correct file path, click on "OK".

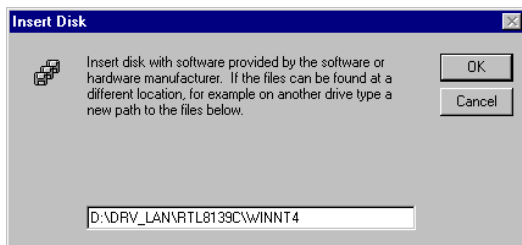

- In the "Select OEM Option" window, click on "OK".

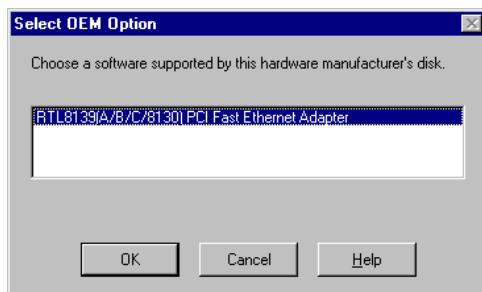

- In the "Duplex mode", click "OK".

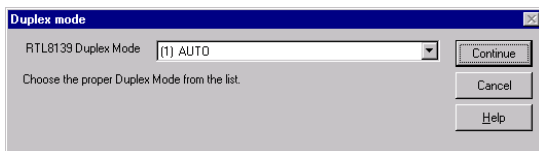

- In the "Network" window, select the "Adapters" tab. Under "Network Adapters:", highlight "Realtek RTL8139CA/B/C(8130)".

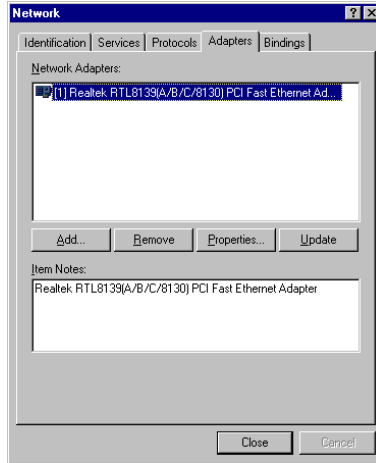

- In the "Microsoft TCP/IP Properties" window, select the "IP Address" tab. Then select "Specify an IP address". Type in the IP Address and Subnet Mask details. Then click on "OK".

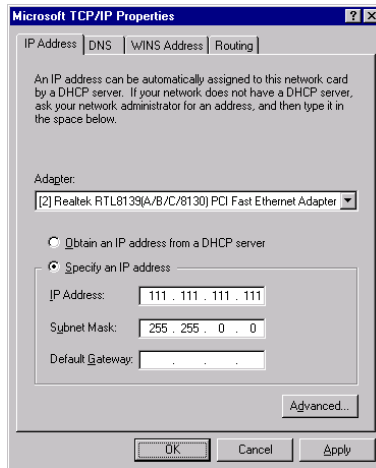

9. In the "Network Settings Change" window, click on "Yes".

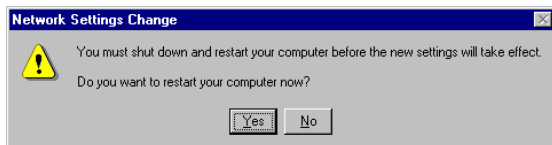

5.6 Windows 2000 Drivers Setup Procedure

Note: The CD-ROM drive is designed as "E" throughout this section.

1. In the "Windows 2000" screen, click on " Start" and select " settings". Then click on the " Control Panel" icon to select "system".

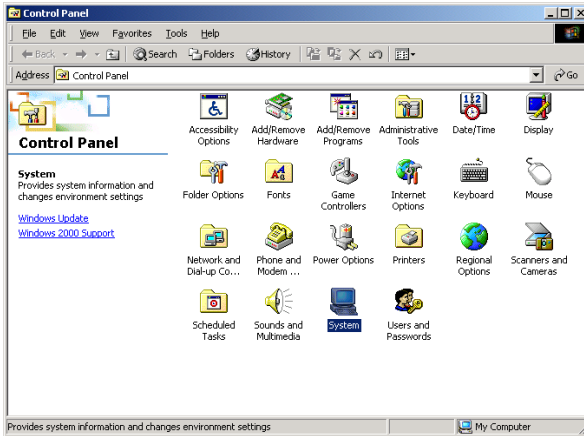

- In the "System Properties" window, select the "Device Manager".

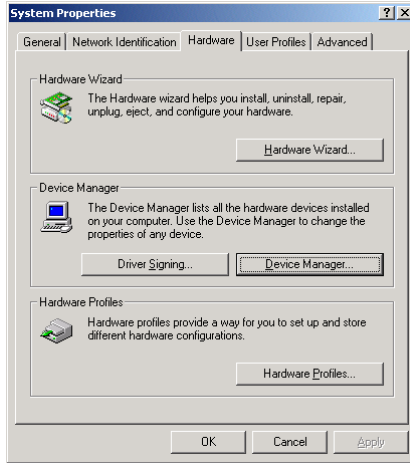

- In "Device Manager" screen, follow the screen instructions, to click on "Properties".

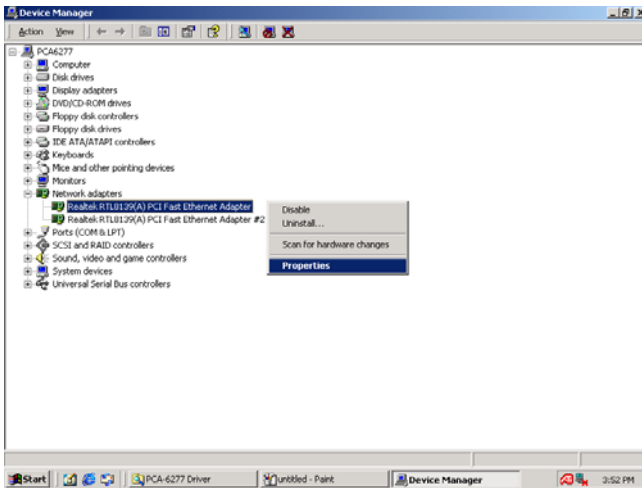

4. In the following screen, to click on "Update Driver".

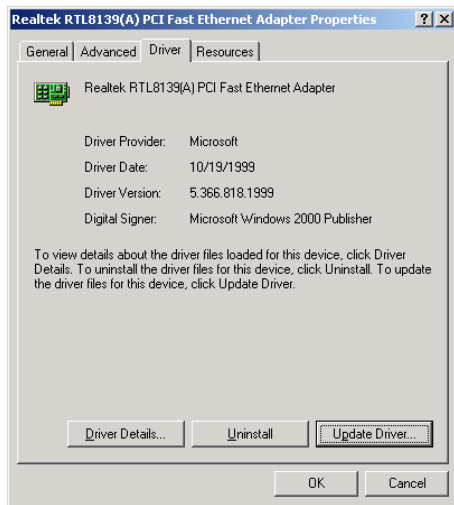

5. Click on "Next".



- Following the highlighted item, and click on "Next".



- Click on "Have Disk".

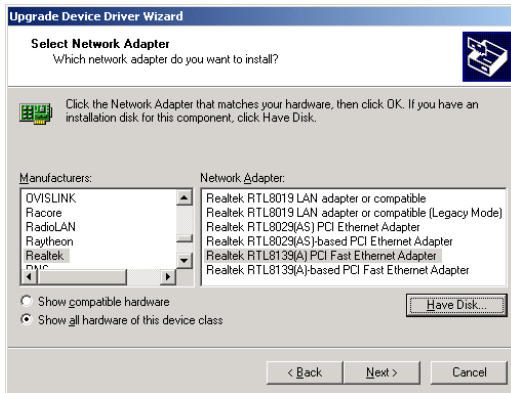

8. Key in "E:\Drv__LAN\RTL8139C\WIN2000", then click on "OK".

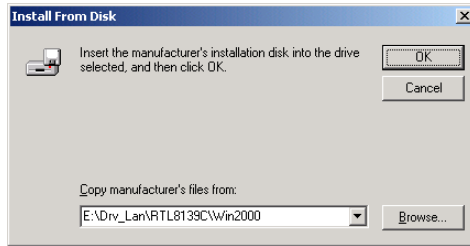

9. To highlight the following item, and click "Next".

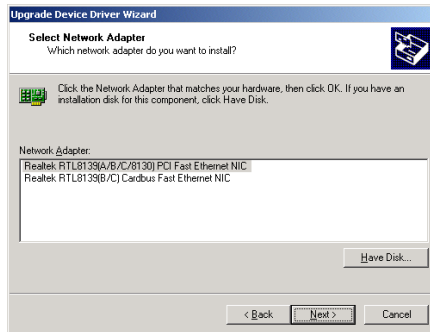

10. Click "Next".

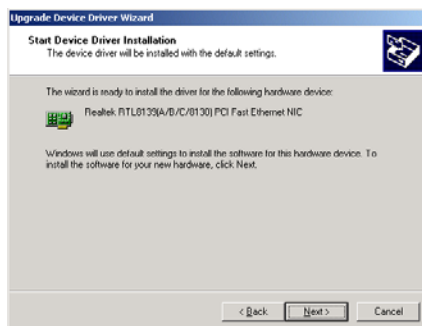

11. Click "Finish" to complete the installation.



SCSI Setup and Configuration

The PCA-6005 features an onboard SCSI interface. This chapter provides basic SCSI concepts and instructions for installing the software drivers with the SCSI driver disks/CD included in your package

Chapter 6 SCSI Setup and Configuration

6.1 Introduction

The PCA-6005 is equipped with an Adaptec AIC-7899 single-chip PCI-to-SCSI host adapter which provides a dual channel Ultra 160 multi-tasking interface between your computer's PCI bus and SCSI devices (disk drives, CD-ROM drives, scanners, tape backups, removable media drives, etc.). Ultra 160 is a new generation of SCSI technology that expands SCSI performance from 80 MBytes/sec to 160 MBytes/sec. Up to a total of 15 SCSI devices can be connected to each of the SCSI connectors.

The AIC-7899 combines this Ultra 160 SCSI technology with Adaptec's SpeedFlex technology. SpeedFlex allows the Adaptec SCSI card to be backwards compatible with previous generations of SCSI products, while allowing newer Ultra 160 SCSI devices to operate at the higher 160 MBytes/sec rate.

There are 3 SCSI connectors on the CPU card: CN50 and CN51 for Ultra 160 devices, and CN52 for 50-pin SCSI devices. You can use Ultra 160 and Ultra wide devices simultaneously without compromising the performance.

If you need to configure the SCSI, the onboard SCSI Select configuration utility allows you to change host adapter settings without opening the computer or handling the board. The SCSI Select utility also contains a utility to low-level format and verifies the disk media on your hard disk drives.

Note: If any peripheral is running at SE mode, the Ultra 160 SCSI segment will run at speeds up to 40 MBytes/sec only instead of 160 MBytes/sec.

6.2 Understanding SCSI

SCSI (pronounced .scuzzy.) stands for Small Computer Systems Interface. SCSI is an industry standard computer interface for connecting SCSI devices to a common SCSI bus.

A SCSI bus is an electrical pathway that consists of a SCSI interface installed in a computer and one or more SCSI devices. SCSI cables are used to connect the devices to the SCSI interface. For the SCSI bus to function properly, a unique SCSI ID must be assigned to the SCSI interface and each SCSI device connected to it, and the SCSI bus must be properly terminated.

6.3 SCSI IDs

Each device attached to the SCSI bus, as well as the SCSI controller itself, must be assigned a unique SCSI ID number from 0 to 15. A SCSI ID uniquely identifies each SCSI device on the SCSI bus and determines priority when two or more devices are trying to use the SCSI bus at the same time.

Refer to the device's documentation to set the SCSI ID. Here are some general guidelines for SCSI IDs:

- For internal SCSI devices, the SCSI ID usually is set by configuring a jumper on the device.
- For external SCSI devices, the SCSI ID usually is set with a switch on the back of the device.
- SCSI ID numbers don't have to be sequential, as long as the SCSI controller and each device has a different number.
- For example, you can have an internal SCSI device with ID 0, and an external SCSI device with ID 6.
- SCSI ID 7 has the highest priority on the SCSI bus. The priority of the remaining IDs, in descending order, is 6 to 0, then 15 to 8.
- The on-board SCSI interface is preset to SCSI ID 7 and should not be changed. This gives it the highest priority on the SCSI bus.
- Most internal SCSI hard disk drives come from the factory pre-set to SCSI ID 0.
- If you have 8-bit (or Narrow) SCSI devices, they must use SCSI IDs 0, 1, 2, 3, 4, 5, or 6. SCSI ID 0 is recommended for the first SCSI hard disk drive.
- If you are booting your computer from a SCSI hard disk drive connected to the SCSI bus, the Boot SCSI ID setting in the SCSISelect utility must correspond to the SCSI ID of the device from which you are booting. By default, the Boot SCSI ID is set to 0. We recommend that you do not change this setting.

- In Windows 95/98, you can use the Device Manager to determine which SCSI ID is assigned to each installed SCSI device.

6.4 Terminating the SCSI Bus

To ensure reliable communication on the SCSI bus, the ends of the SCSI bus must be properly terminated. This is accomplished when the device at the end of the each cable, or the end of the cable itself, has a terminator installed (or enabled). Terminators must be removed, or termination must be disabled, on devices between the ends of each cable.

Since the method for terminating a SCSI device can vary widely, refer to the device's documentation for instructions on how to enable or disable termination. Here are some general guidelines for termination:

- Internal Ultra 160 and Ultra 2 SCSI devices come from the factory with termination disabled and cannot be changed. Proper termination for internal Ultra 160 and Ultra2 SCSI devices is provided by a 68-pin Internal LVD (low voltage differential) SCSI cable, which has a built-in terminator at its end.
- Termination on non-Ultra 160 and Ultra2 internal SCSI devices usually is controlled by manually setting a jumper or a switch on the device, or by physically removing or installing one or more resistor modules on the device.
- Termination on most external SCSI devices is controlled by installing or removing a SCSI terminator. However, termination on some external SCSI devices is enable or disabled by setting a switch on the back of the SCSI device.

The last external Ultra160 or Ultra2 SCSI device must be terminated with an LVD/SE (low voltage differential/single ended) terminator plug to ensure that the device will operate at its maximum speed. If you use a different kind of terminator plug, the data I/O rate will decrease.

By default, termination on the SCSI controller itself is set to Automatic (the preferred method). We recommend that you do not change this default setting.

6.5 Configuring the SCSI interface with SCSISelect

SCSISelect, included with the CPU card, enables you to change SCSI settings without opening the computer. SCSISelect also enables you to low-

level format or verify the disk media of your SCSI hard disk drives. The following table lists the available and default settings for each SCSISelect option.

Note: The default settings are appropriate for most systems. Run SCSISelect if you need to change or view current settings, or if you would like to run the SCSI disk utilities.

SCSISelect Options	Available Settings	Default Setting
SCSI Bus Interface		
Definitions:		
Host Adapter SCSI ID	0-15	7
SCSI Parity Checking	Enable, Disabled	Enabled
Host Adapter SCSI Termination		
LVD/SE Connectors		
SE Connectors	Automatic	Automatic
	Enabled	
	Disabled	
SE Connectors	Automatic	Automatic
	Low On/High On	
	Low Off/High Off	
	Low Off/High On	
Boot Device Options:		
Boot SCSI ID	0-15	0
BootLUNNumber1	0-7	0

SCSI Device Configuration:
Sync Transfer Rate (MBytes/sec)

	160, 80.0, 53.4, 40.0,	160
	32.0, 26.8, 20.0,	
	16.0, 13.4, 10.0	
	ASYN	
Initiate Wide Negotiation	Yes, No	Yes (enabled)
Enable Disconnection	Yes, No	Yes (enabled)
Send Start Unit Command	Yes, No	Yes (enabled)
Enable Write Back Cache2	N/C (No Change)	N/C (No Change)
	Yes, No	
BIOS Multiple LUN Support2	Yes, No	No (disabled)
Include in BIOS Scan2	Yes, No	Yes (enabled)
Advanced Configuration Options:		
Reset SCSI Bus at IC Initialization	Enabled, Disabled	Enabled
Display <Ctrl><A> Messages during BIOS Initialization	Enabled, Disabled	Enabled
Extended BIOS Translation for DOS Drives > 1 GByte	Enabled, Disabled	Enabled
Verbose/Silent Mode	Verbose, Silent	Verbose
HostAdapterBIOS	Enabled	Enabled
	Disabled : Not Scan	
	Disabled: Scan Bus	
Domain Validation2	Enabled, Disabled	Enabled
Support Removable Disks Under BIOS as Fixed Disks2	Disabled	Disabled
	Boot Only,	
	All Disks	
BIOS Support for BootableCD_ROM2	Enabled, Disabled	Enabled

BIOS Support for Int 13	Enabled, Disabled	Enabled
Extensions2		
1 Setting is valid only if Multiple LUN Support is enabled.		
2 Settings are valid only if host adapter BIOS is enabled.		

6.6 Starting SCSISelect

Follow these steps to start SCSISelect:

1. Turn on or restart your system. During the startup process, pay careful attention to the messages that appear on your screen.
2. When the following message appears on your screen, press the Ctrl-A keys simultaneously (this message appears for only a few seconds): Press <Ctrl><A> for SCSISelect (TM) Utility!
3. From the menu that appears, use the arrow keys to move the cursor to the option you want to select, then press ENTER.

Note: If you have difficulty viewing the display, press F5 to toggle between color and monochrome modes. (This feature may not work on some monitors.)

Exiting SCSISelect

Follow these steps to exit SCSISelect:

1. Press ESC until a message prompts you to exit (if you changed any settings, you are prompted to save the changes before you exit.) At the prompt, select YES to exit, then press any key to reboot the computer. Any changes you made in SCSISelect take effect after the computer boots.

Using SCSISelect Settings

To select an option, use the arrow keys to move the cursor to the option, then press ENTER. In some cases, selecting an option displays another menu. You can return to the previous menu at any time by pressing ESC. To restore the original SCSISelect default values, press F6 from the main SCSISelect screen

SCSI Bus Interface Definitions

- **Host Adapter SCSI ID**-(Default: 7) Sets the SCSI ID for the SCSI controller. The Adaptec SCSI controller AIC-7899 is set at 7, which gives it the highest priority on the SCSI bus. We recommend that you do not change this setting.
- **SCSI Parity Checking**-(Default: Enabled) When set to Enabled, verifies the accuracy of data transfer on the SCSI bus. Leave this setting enabled unless any SCSI device does not support SCSI parity.
- **Host Adapter SCSI Termination**-(Default: Automatic) Determines the termination setting for the SCSI card. The default setting for both the LVD/SE (low voltage differential/single ended) connectors and SE connectors is Automatic, which allows the SCSI card to adjust the termination as needed depending on the configuration of the connected SCSI devices. We recommend that you do not change these settings.

Boot Device Options

- **Boot SCSI ID**-(Default: 0) Specifies the SCSI ID of your boot device. We recommend that you do not change the default setting.
- **Boot LUN Number**-(Default: 0) Specifies which LUN (Logical Unit Number) to boot from on your boot device. This setting is not valid unless Multiple LUN Support is **Enabled**

SCSI Device Configuration

SCSI Device Configuration options can be set individually for each connected SCSI device.

Note: To configure settings for a SCSI device, you must know its SCSI ID

- **Sync Transfer Rate**-(Default: 160) Determines the maximum synchronous data transfer rate that the SCSI card supports. Use the maximum value of 160 MBytes/sec.
- **Initiate Wide Negotiation**-(Default: Yes) When set to Yes, the SCSI card attempts 16-bit data transfer (wide negotiation.) When set to No, the SCSI card uses 8-bit data transfer unless the SCSI device requests wide negotiation.

Note: Set Initiate Wide Negotiation to NO if you are using an 8-bit SCSI device that hangs or exhibits other performance problems with 16-bit data transfer rate enabled.

- **Enable Disconnection**-(Default: Yes) When set to Yes, allows the SCSI device to disconnect from the SCSI bus. Leave the setting at Yes if two or more SCSI device is connected, changing the setting to No results in slightly better performance.
- **Send Start Unit Command**-(Default: Yes) When set to Yes, the Start Unit Command is sent to the SCSI device at bootstrap.

The following three options have no effect if the SCSI Card BIOS is disabled. (The SCSI Cards BIOS is normally enabled by default.)

- **Enable Write Back Cache**-(Default: N/C) Can be used to enable or disable the write-back cache on SCSI disk drives connected to the host adapter. Leave this option at its default setting of N/C (no change), which usually allow for optimum drive performance.
- **BIOS Multiple LUN Support**-(Default: No) Leave this setting at No if the device does not have multiple Logical Unit Numbers (LUNs.) When set to Yes, the SCSI card BIOS provides boot support for a SCSI device with multiple LUNs (for example, a CD juke box. device in which multiple CDs can be accessed simultaneously.)
- **Include in BIOS Scan**-(Default: Yes) When set to Yes, the SCSI card BIOS includes the device as part of its BIOS scan at bootstrap.

Advanced Configuration Options

Note: Do not change the Advanced Configuration Options unless absolutely necessary.

- **Reset SCSI Bus at IC Initialization**-(Default: Enabled) When set to Enabled, the SCSI card generates a SCSI bus reset during its power-on initialization and after a hard reset.
- **Display <Ctrl> <A> Messages during BIOS Initialization**-(Default: Enabled) When set to Enabled, the SCSI card BIOS displays the Press <Ctrl> <A> for SCISelect (TM) Utility! message on your screen during system bootstrap. If this setting disabled, you can still invoke the

SCSISelect Utility by pressing <Ctrl> <A> after the SCSI card BIOS banner appears.

- **Extended BIOS Translation for DOS Drives > 1 GByte**-(Default: Enabled) When set to **Enabled**, provides an extended translation scheme for SCSI hard disks with capacities greater than 1 GByte. This setting is necessary only for MS-DOS 5.0 or above; it is not required for other operating systems, such as NetWare or UNIX.

Caution: Changing the translation scheme destroys all data on the drive. Be sure to back your disk drives before changing the translation scheme.

Use the MS-DOS Fdisk command to partition a disk larger than 1GByte controlled by the SCSI card BIOS, when using DOS, Windows 3.1.x, or Windows 95/98.

- **Verbose/Silent Mode**-(Default: Verbose) When set to Verbose, the SCSI card BIOS displays the host adapter model on the screen during system buildup. When set to **Silent**, the message is not displayed during bootup.
- **Host Adapter BIOS (Configuration Utility Reserves BIOS Space)**-(Default: Enabled) Enables or disables the SCSI card BIOS.
- Leave at **Enabled** to allow the SCSI card BIOS to scan and initialize all SCSI devices.
- Set to **Disabled: Not scan** if the devices on the SCSI bus (for example, CD-ROM drives) are controlled by software drivers and do not need the BIOS, and you do not want the BIOS to scan the SCSI bus.
- Set to **Disabled: Scan Bus** if you do not need the BIOS, but you want it to scan the SCSI devices on the bus and you need to spin up the devices.

The following four options have no effect when the SCSI Card BIOS is disabled. (The SCSI Card BIOS is normally enabled by default.)

- **Domain Validation**.(Default: Enabled) Determines the optimal transfer rate for each device on the SCSI bus and sets transfer rates accordingly. Displays the resulting data transfer rate.
- **Support Removable Disks Under BIOS as Fixed Disks**. (Default: Disabled) Determines which removable-media drives are supported by the SCSI card BIOS. Choices are as follows:

- **Disabled.** No removable-media drives are treated as hard disk drives. Software drivers are required because the drives are not controlled by the BIOS.
- **Boot Only.** Only the removable-media drive designated as the boot device is treated as a hard disk drive.
- **All Disks.** All removable-media drives supported by the BIOS are treated as hard disk drives.

Caution: You may lose data if you remove a removable-media cartridge from a SCSI drive controlled by the SCSI card BIOS while the drive is on. If you want to be able to remove the media while the drive is on, install the removable-media software driver and set Support Removable Disks Under BIOS as Fixed Disks to **Disabled**.

- **BIOS Support for Bootable CD-ROMs.**(Default: Enabled) When set to Enabled, the SCSI card BIOS allows the computer to boot from a CD-ROM drive.
- **BIOS Support for Int 13 Extensions.**(Default: Enabled) When set to Enabled, the SCSI card BIOS supports Int 13h extensions as required by Plug-and-Play. The setting can be either enabled or disabled if your system is not Plug-and-Play.

6.7 Using SCSI Disk Utilities

To access the SCSI disk utilities, follow these steps:

1. Select the SCSI Disk Utilities option from the menu that appears after starting SCSISelect. SCSISelect scans the SCSI bus (to determine the devices installed) and displays a list of all SCSI

6.8 Installation under Windows NT/Windows 2000

If you are only using SCSI hard drives without any IDE HDD drive installed. Please follow these steps:

1. Insert Windows NT/Windows 2000 CD Disk.

2. Press F6 immediately when it displays: “Set up is inspecting your computer’s hardware configuration.”
3. Then it enter SCSI installation. Please insert SCSI driver floppy disk.

6.9 Windows 9X Driver setup procedure

1. In the window 9x screen, click on “start” and select “setting”. Then click on the “Control Panel” icon to select .System.

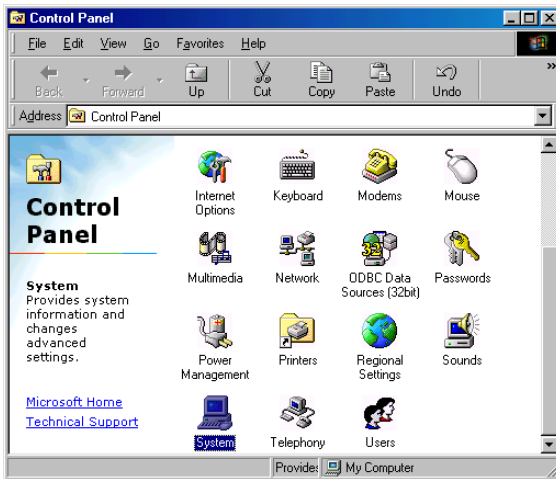

2. In the “System properties”, choose “PCI SCSI Bus Controller.” Then click on “Properties.”

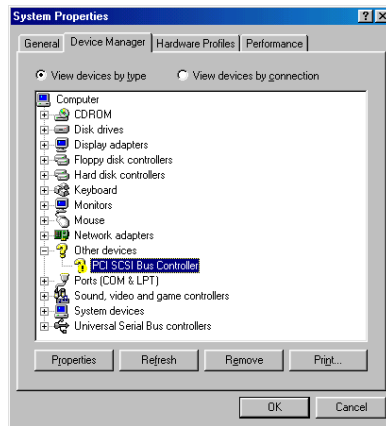

3. Click on "Update Driver"



4. Click on “Next”



5. Recommend to search for a better driver

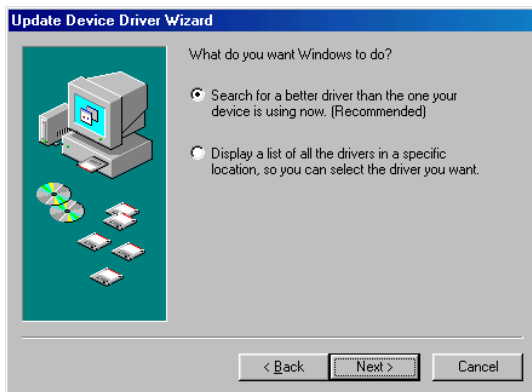

6. If the SCSI driver is supplied in floppy disk, click on "Floppy disk drives." Then, click on "Next." If the SCSI driver is supplied in CD-ROM disk, click on "Specify a location:" then enter "E:\Drv_SCSI\AIC7899\Windows\Win9X"

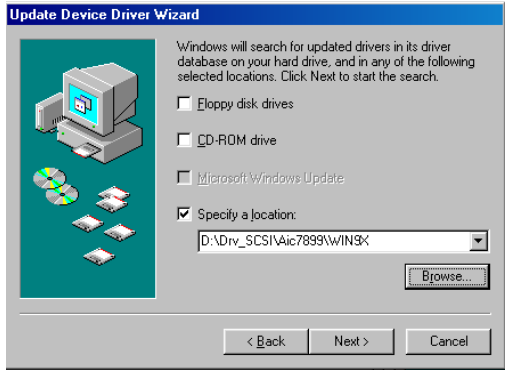

7. In the "Update Device Driver Wizard" click on "Next."

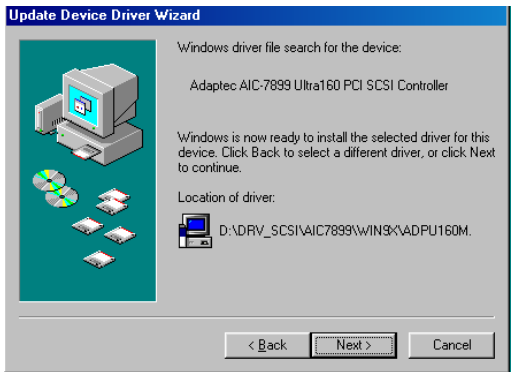

8. The installation is completed. Click on "Finish."

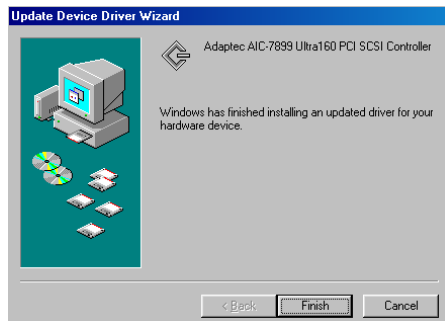

9. Click on "Yes" to restart the system.

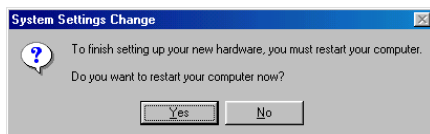

6.10 Windows NT Driver Setup Procedure

1. In the Windows NT screen, click on “Start” and select “Setting.” Then click on the “Control Panel” icon to select “SCSI Adapter.”



2. In the SCSI Adapter, choose “Drivers.” Click on “Add to install SCSI driver.”

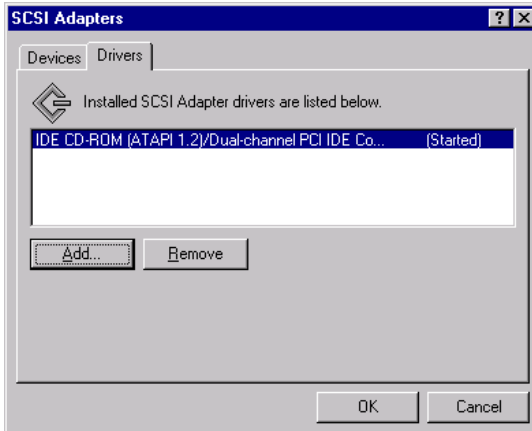

3. Click on "Have Disk."

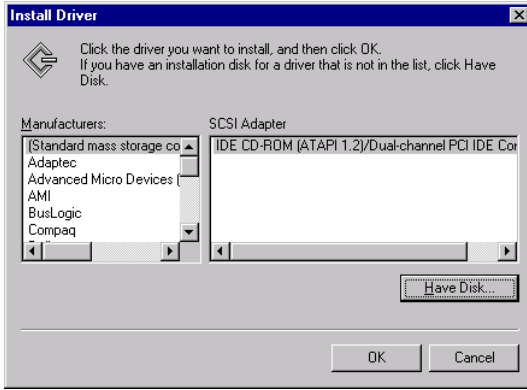

4. Click on "Browse. to select the drivers." If the SCSI driver is supplied in floppy disk, choose the directory A:1.

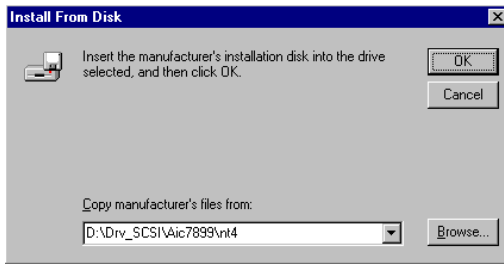

5. Click the SCSI driver, and then click "OK."

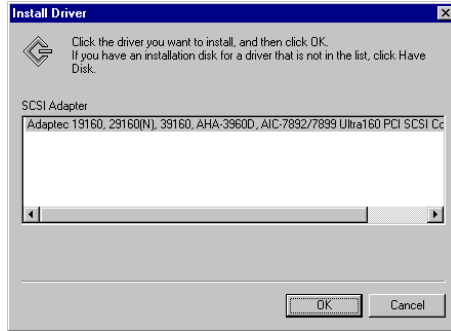

6. The installation of SCSI Driver is completed. Click on "OK."

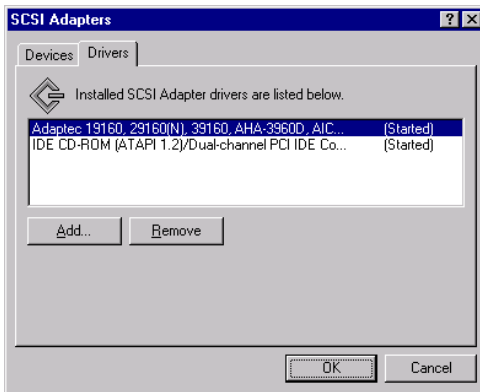

Programming the Watchdog Timer

The PCA-6005 is equipped with a watchdog timer that resets the CPU if processing comes to a standstill for any reason. This feature ensures system reliability in industrial standalone or unmanned environments.

Appendix A Programming the watchdog

A.1 Programming the watchdog

The PCA-6005's watchdog timer can be used to monitor system software operation and take corrective action if the software fails to function after the programmed period. This section describes the operation of the watchdog timer and how to program it.

A.1.1 Watchdog timer overview

The watchdog timer is built-in in the super I/O controller IT8705F. It provides the following functions for user programming:

- Can be enabled and disabled by user's program.
- Timer can be set from 1 to 255 seconds or 1 to 255 minutes.
- Resets the system signal if the software fails to reset the timer before time-out.

Note: *The interrupt output of the watchdog timer is a low level signal. It will be held low until the watchdog timer is reset.*

A.1.2 Programming the Watchdog Timer

The I/O port address of the watchdog timer is 2E(hex) and 2F(hex). 2E(hex) is the address port. 2F(hex) is the data port. You must first assign the address of register by writing address value into address port 2E(hex), then write/read data to/from the assigned register through data port 2F(hex).

A.1.3 Unlock the Super I/O IT8705F

Unlock the super I/O controller by writing the special key 087h, 001h, 055h and 055h before starting programming the watchdog timer.

A.1.4 Select and program the watchdog timer

Select watchdog timer by writing the logical device number (LDN) 05h to the I/O port. Then you can enable WDT and set the timer by writing value to the registers..

A.1.5 Select and enable the game port

The game port is used to reset the watchdog timer. Select game port by writing the logical device number (LDN) 06h to the I/O port. Enable the game port to enable the read/write action to reset the WDT.

A.1.6 Lock the Super I/O IT8705F

After setting the WDT and game port, lock it back to prevent unintended access.

A.1.7 Resetting the Watchdog Timer

Any read or write action from/to the game port will reset the watchdog timer.

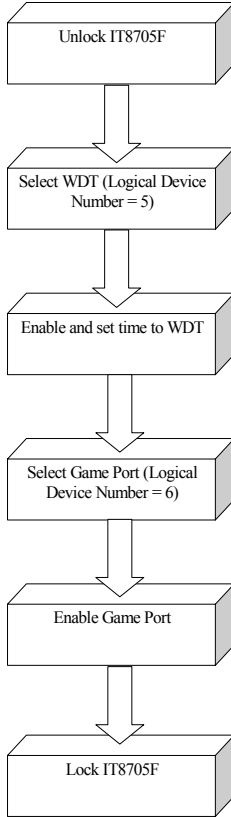

A.1.8 List of Registers

Watchdog Timer configuration Registers (LDN = 05h)

Watchdog Timer Control Register (Index = FBh, Default = 00h)

Bit	Description
7	This bit must be set to 0
6-5	Reserved
4	Enable read/write to the game port base address to reset the WDT counter.0: Disable a read from or write to game port base address to reset WDT counter (default)1: Enable a read from or write to game port base address to reset WDT counter
3	WDT counter unit select0: Minute (default)1: Second
2	Reserved
1	Direct time out controlThis bit is self-cleaning.0: Normal (default)1: Direct time our regardless of the counter.
0	WDT status0: No time-out after last re-load counter value (default).1: The timer was time-out.

Watchdog Timer Time-out Value Register (Index = FDh, Default = 00h)

Bit	Description
7-0	Watchdog timer time-out valueWatchdog timer counter time-out value (1 ~ 256 units)

Game Port Configuration Registers (LDN = 06h)

Game Port Activate (Index = 30h, Default =00h)

Bit	Description
7-1	Reserved
0	Game Port Enable1: Enabled0: Disabled

Game Port Base Address MSB Register (Index = 60h, Default = 02h)

Bit	Description
7-4	Read only with "0h" for Base Address [15:12]
3-0	Game Port Base Address MSBRead/Write, mapped as Base Address [11:8]

Game Port Base Address LSB Register (Index = 61h, Default = 01h)

Bit	Description
-----	-------------

7-0	Game Port Base Address LSBRead/Write, mapped as Base Address [7:0]
-----	--

Programming Examples

```
;-----  
;Input :(AH) - register index  
;          (AL) - Value to write  
;-----  
Set_8705_Reg proc  near  
push      ax  
mov       dx, 2Eh  
mov       al, ah  
out       dx, al  
out       80h, al      ; for I/O delay  
pop       ax  
inc       dx  
out       dx, al  
ret  
Set_8705_Reg endp  
;-----  
;Input : (AL) - logic device to be selected  
;-----  
Select_Logic_Deviceproc  near  
mov       ah, 07h  
call      Set_8705_Reg  
ret  
Select_Logic_DeviceEndp  
Key8705db 087h, 001h, 055h, 055h  
Unlock_8705ProcNear  
mov       si, offset cs:Key8705  
mov       dx, 2Eh  
mov       cx, 4
```

@@:

```
mov     al, byte ptr cs:[si]
out     dx, al
inc     si
loop    short @B
ret
```

Unlock_8705Endp

Lock_8705ProcNear

```
mov     ah, 02h
mov     al, 02h
call    Set_8705_Reg
ret
```

Lock_8705Endp

;

; Enable watchdog timer and 10 seconds as timeout interval

;

:

:

:

call Unlock_8705 ; Unlock 8705

mov al, 5 ; Select watchdog function

call Select_Logic_Device

mov ah, 30h ; Enable watchdog function

mov al, 1

call Set_8705_Reg

mov ah, 0FBh ; Set counter unit (second)

mov 1, 00011000b

call Set_8705_Reg

mov ah, 0FCh ; Use GP67 (pin 85)

mov al, 37h

```

call    Set_8705_Reg
        mov     ah, 0FDh    ; Set time-out value
        mov     al, 10
call    Set_8705_Reg
mov     al, 6              ; Select game port function
call    Select_Logic_Device
        mov     ah, 30h    ; Enable game port function
        mov     al, 1
call    Set_8705_Reg
        mov     ah, 60h    ; Set game port address 201h
        mov     al, 02h
call    Set_8705_Reg
        mov     ah, 61h
        mov     al, 01h
call    Set_8705_Reg
        call    Lock_8705  ; Lock 8705
:
:
:
;
; Enable watchdog timer and 5 minutes as timeout interval
;
:
:
:
        call    Unlock_8705 ; Unlock 8705
mov     al, 5              ; Select watchdog function
call    Select_Logic_Device
        mov     ah, 30h    ; Enable watchdog function
        mov     al, 1
call    Set_8705_Reg

```

```

        mov     ah, 0FBh    ; Set counter unit (minute)
        mov     al, 00010000b
call    Set_8705_Reg
        mov     ah, 0FCh    ; Use GP67 (pin 85)
        mov     al, 37h
call    Set_8705_Reg
        mov     ah, 0FDh    ; Set time-out value
        mov     al, 5
call    Set_8705_Reg
mov     al, 6                ; Select game port function
call    Select_Logic_Device
        mov     ah, 30h     ; Enable game port function
        mov     al, 1
call    Set_8705_Reg
        mov     ah, 60h     ; Set game port address 201h
        mov     al, 02h
call    Set_8705_Reg
        mov     ah, 61h
        mov     al, 01h
call    Set_8705_Reg
        call    Lock_8705   ; Lock 8705
:
:
:
;
; To reset the watchdog timer before the interval expires
;
:
:
:
        mov     dx,201h

```

in al,dx

:
:
:

I/O Pin Assignments

This appendix contains information of a detailed or specialized nature. It includes:

- IDE Hard Drive Connector
- Floppy Drive Connector
- Parallel Port Connector
- SCSI Connector
- USB Connector
- VGA Connector
- Ethernet 10/100Base-T RJ-45 Connector
- COM1/COM2 RS-232 Serial Port
- Keyboard and Mouse Connector
- External Keyboard Connector
- IR Connector
- CPU Fan Power Connector
- Power LED and Keylock Connector
- External Speaker Connector
- Reset Connector
- HDD LED Connector
- ATX Feature Connector
- ATX Soft Power Switch
- SM Bus Connector
- Extension I/O Board Connector
- System I/O Ports
- DMA Channel Assignments
- Interrupt Assignments
- 1st MB Memory Map

Appendix B Pin Assignments

B.1 IDE Hard Drive Connector (CN1, CN2)

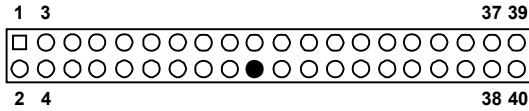

IDE hard drive connector (CN1, CN2)			
Pin	Signal	Pin	Signal
1	IDE RESET*	2	GND
3	DATA 7	4	DATA 8
5	DATA 6	6	DATA 9
7	DATA 5	8	DATA 10
9	DATA 4	10	DATA 11
11	DATA 3	12	DATA 12
13	DATA 2	14	DATA 13
15	DATA 1	16	DATA 14
17	DATA 0	18	DATA 15
19	SIGNAL GND	20	N/C
21	DISK DMA REQUEST	22	GND
23	IO WRITE	24	GND
25	IO READ	26	GND
27	IO CHANNEL READY	28	GND
29	HDACKO*	30	GND
31	IRQ14	32	N/C
33	ADDR 1	34	N/C
35	ADDR 0	36	ADDR 2
37	HARD DISK SELECT 0*	38	HARD DISK SELECT 1*
39	IDE ACTIVE*	40	GND

* low active

B.2 Floppy Drive Connector (CN3)

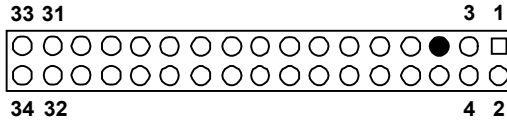

Table B-2: Floppy drive connector (CN3)

Pin	Signal	Pin	Signal
1	GND	2	FDHDIN*
3	GND	4	N/C
5	N/C	6	FDEDIN*
7	GND	8	INDEX*
9	GND	10	MOTOR 0*
11	GND	12	DRIVE SELECT 1*
13	GND	14	DRIVE SELECT 0*
15	GND	16	MOTOR 1*
17	GND	18	DIRECTION*
19	GND	20	STEP*
21	GND	22	WRITE DATA*
23	GND	24	WRITE GATE*
25	GND	26	TRACK 0*
27	GND	28	WRITE PROTECT*
29	GND	30	READ DATA*
31	GND	32	HEAD SELECT*
33	GND	34	DISK CHANGE*

* low active

B.3 Parallel Port Connector (CN4)

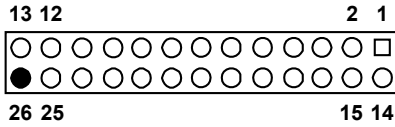

Table B-3: Parallel port connector (CN4)

Pin	Signal	Pin	Signal
1	STROBE*	14	AUTOFD*
2	D0	15	ERR
3	D1	16	INIT*
4	D2	17	SLCTINI*
5	D3	18	GND
6	D4	19	GND
7	D5	20	GND
8	D6	21	GND
9	D7	22	GND
10	ACK*	23	GND
11	BUSY	24	GND
12	PE	25	GND
13	SLCT	26	N/C

* low active

B.4 USB Connector (CN6)

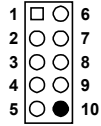

Table B-4: USB1/USB2 connector (CN6)

Pin	USB1 Signal	Pin	USB2 Signal
1	+5 V	6	+5 V
2	UV-	7	UV-
3	UV+	8	UV+
4	GND	9	GND
5	Chassis GND	10	N/C

B.5 VGA Connector (CN7)

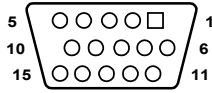

Table B-5: VGA connector (CN7)

Pin	Signal	Pin	Signal
1	RED	9	VCC
2	GREEN	10	GND
3	BLUE	11	N/C
4	N/C	12	SDT
5	GND	13	H-SYNC
6	GND	14	V-SYNC
7	GND	15	SCK
8	GND		

B.6 Keyboard and Mouse Connector CN11)

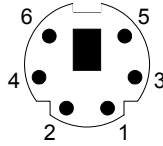

Table B-6: Keyboard and mouse connector (CN11)

Pin	Signal
1	KB DATA
2	MS DATA
3	GND
4	VCC
5	KB CLOCK
6	MS CLOCK

B.7 External Keyboard Connector (CN12)

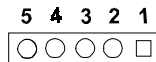

Table B-7: External keyboard connector (CN12)

Pin	Signal
1	CLK
2	DATA
3	NC
4	GND
5	VCC

B.8 IR Connector (CN13)

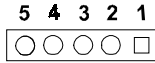

Table B-8: IR connector (CN13)

Pin	Signal
1	+5 V
2	NC
3	IR_RX
4	GND
5	IR_TX

B.9 CPU Fan Power Connector (CN14)



Table B-9: CPU fan power connector (CN14)

Pin	Signal
1	GND
2	+12 V
3	Detect

B.10 Power LED (CN16)

You can use an LED to indicate when the CPU card is on. Pin 1 of CN16 supplies the LED's power, and Pin 3 is the ground.

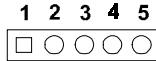

Table B-10: Power LED and keylock connector (CN16)

Pin	Function
1	LED power (+5 V)
2	NC
3	GND
4	Reserved
5	GND

B.11 External Speaker Connector (CN17)

The CPU card has its own buzzer. You can also connect it to the external speaker on your computer chassis.

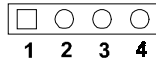

Table B-11: External speaker (CN17)

Pin	Function
1	+5 VCC
2	GND
3	Internal buzzer
4	Speaker out

B.12 Reset Connector (CN18)



Table B-12: Reset connector (CN18)

Pin	Signal
1	RESET
2	GND

B.13 HDD LED Connector (CN19)



Table B-13: HDD LED connector (CN19)

Pin	Signal
1	LED0 (LED-)
2	Vcc(LED+)

B.14 ATX Feature Connector (CN20)



Table B-14: ATX feature connector (CN20)

Pin	Signal
1	PS-ON
2	VCC
3	VCCSB

B.15 ATX Soft Power Switch (CN21)



Table B-15: ATX soft power switch (CN21)

Pin	Signal
1	5VSB
2	PWR-BTN

B.16 SM Bus Connector (CN29)



Table B-16: SM Bus connector (CN29)

Pin	Signal
1	SMB_DATA
2	SMB_CLK

B.17 System I/O Ports

Table B-17: System I/O ports

Addr. range (Hex)	Device
000-01F	DMA controller
020-021	Interrupt controller 1, master
022-023	Chipset address
040-05F	8254 timer
060-06F	8042 (keyboard controller)
070-07F	Real-time clock, non-maskable interrupt (NMI) mask
080-09F	DMA page register
0A0-0BF	Interrupt controller 2
0C0-0DF	DMA controller
0F0	Clear math co-processor
0F1	Reset math co-processor
0F8-0FF	Math co-processor
1F0-1F8	Fixed disk
200-207	Game I/O
278-27F	Parallel printer port 2 (LPT3)
290-297	On-board hardware monitor
2F8-2FF	Serial port 2
300-31F	Prototype card

Table B-17: System I/O ports

360-36F	Reserved
378-37F	Parallel printer port 1 (LPT2)
380-38F	SDLC, bisynchronous 2
3A0-3AF	Bisynchronous 1
3B0-3BF	Monochrome display and printer adapter (LPT1)
3C0-3CF	Reserved
3D0-3DF	Color/graphics monitor adapter
3F0-3F7	Diskette controller
3F8-3FF	Serial port 1
2E-2F	Watchdog timer

B.18 DMA Channel Assignments

Table B-18: DMA channel assignments

Channel	Function
0	Available
1	Available
2	Floppy disk (8-bit transfer)
3	Available
4	Cascade for DMA controller 1
5	Available
6	Available
7	Available

B.19 Interrupt Assignments

Table B-19: Interrupt assignments

Priority	Interrupt#	Interrupt source
1	NMI	Parity error detected
2	IRQ0	Interval timer
3	IRQ1	Keyboard
-	IRQ2	Interrupt from controller 2 (cascade)
4	IRQ8	Real-time clock
5	IRQ9	Cascaded to INT 0A (IRQ 2)
6	IRQ10	Available
7	IRQ11	Available
8	IRQ12	PS/2 mouse
9	IRQ13	INT from co-processor
10	IRQ14	Fixed disk controller
11	IRQ15	Available
12	IRQ3	Serial communication port 2
13	IRQ4	Serial communication port 1
14	IRQ5	Parallel port 2
15	IRQ6	Diskette controller (FDC)
16	IRQ7	Parallel port 1 (print port)

B.20 1st MB Memory Map

Table B-20: 1st MB memory map

Addr. range (Hex)	Device
F0000h - FFFFFh	System ROM
CC000h - EFFFFh	Unused
C0000h - CBFFFh	VGA BIOS
B8000h - BFFFFh	CGA/EGA/VGA text
B0000h - B7FFFh	Unused
A0000h - AFFFFh	EGA/VGA graphics
00000h - 9FFFFh	Base memory

B.21 PCI Bus Map

Table B-21: PCI bus map

Function	Signals:		
	Device ID	INT# pin	GNT# pin
Onboard LAN1	AD24	INT C	GNT E
Onboard LAN2	AD25	INT D	GNT A
Onboard SCSI	AD19	INT B, D	GNT F
PCI slot 1	AD31	INT B, C, D, A	GNT A
PCI slot 2	AD30	INT C, D, A, B	GNT B
PCI slot 3	AD29	INT D, A, B, C	GNT C
PCI slot 4	AD28	INT A, B, C, D	GNT D

Note: In the PCA-6005E2 and PCA-6005F, the LAN2 controller uses "GNT A" signals which is also used by PCI slot 1. Therefore, PCI slot 1 cannot be used for plug-in bus master add-on cards such as SCSI cards or LAN cards.

