

# MIC-3000 Series

## USER'S Manual

### MIC-3359

**6U CompactPCI® Intel®  
Desktop Pentium® 4 &  
Mobile Pentium® 4-M  
Processor Board with VGA  
on Board**

*Advantech CompactPCI®  
Modular Industrial Computer*

## **Copyright Notice**

This document is copyrighted, 2005. All rights are reserved. The original manufacturer reserves the right to make improvements to the products described in this manual at any time without notice. No part of this manual may be reproduced, copied, translated or transmitted in any form or by any means without the prior written permission of the original manufacturer. Information provided in this manual is intended to be accurate and reliable. However, the original manufacturer assumes no responsibility for its use, nor for any infringements upon the rights of third parties which may result from its use.

## **Acknowledgements**

PICMG™, CompactPCI® and the PICMG™, CompactPCI® logos are trademarks of the PCI Industrial Computers Manufacturers Group. All other product names or trademarks are properties of their respective owners.

## **CE Notification**

The MIC-3359, developed by Advantech Co., Ltd., has passed the CE test for environment specifications when shielded cables are used for external wiring. We recommend the use of shielded cables.

## **FCC**

This device complies with the requirements in part 15 of the FCC rule: Operation is subject to be following two conditions :

- (1) This device may not cause harmful interference.
- (2) This device must accept any interference received, including interference that may cause undesired operation.

## **CAUTION!!**

Danger of explosion if battery is not correctly replaced. The battery need not to be charged. Replace only with Advantech-specified batteries.

## **Product warranty**

Advantech warrants to you, the original purchaser, that each of its products will be free from defects in materials and workmanship for one year from the date of purchase.

This warranty does not apply to any products which have been repaired or altered by persons other than repair personnel authorized by Advantech, or which have been subject to misuse, abuse, accident or improper installation. Advantech assumes no liability under the terms of this warranty as a consequence of such events.

Because of Advantech's high quality-control standards and rigorous testing, most of our customers never need to use our repair service. If an Advantech product is defective, it will be repaired or replaced at no charge during the warranty period. For out-of-warranty repairs, you will be billed according to the cost of replacement materials, service time and freight. Please consult your dealer for more details.

If you think you have a defective product, follow these steps:

- 1、 Collect all the information about the problem encountered. For example, CPU speed, Advantech products used, other hardware and software used, etc. Note anything abnormal and list any on-screen messages you get when the problem occurs.
- 2、 Call your dealer and describe the problem. Please have your manual, product, and any helpful information readily available.
- 3、 If your product is diagnosed as defective, obtain an RMA (return merchandise authorization) number from your dealer. This allows us to process your return more quickly.
- 4、 Carefully pack the defective product, a fully-completed Repair and Replacement Order Board and a photocopy proof of purchase date (such as your sales receipt) in a shippable container. A product returned without proof of the purchase date is not eligible for warranty service.
- 5、 Write the RMA number visibly on the outside of the package and ship it prepaid to your dealer.

## **Packing List**

Before installation, ensure that the following materials have been received:

- 1 MIC-3359 all-in-one single board computer
- 1 Utility and user manual (PDF file) CD-ROM disc
- 1 CPU Heat sink (Assembled)
- 1 Thermal pad for Pentium 4-M CPU
- 1 Solder-side cover (Assembled)
- Several screws
- 1 warranty certificate document

If any of these items are missing or damaged, contact your distributor or sales representative immediately.

## **Technical Support and Sales Assistance**

If you have any technical questions about the MIC-3359 or any other Advantech products, please visit our support website at:

- <http://www.advantech.com.tw/support>

For more information about Advantech's products and sales information, please visit:

- <http://www.advantech.com>

# Contents

<b>Contents</b> .....	<b>IV</b>
<b>Tables</b> .....	<b>VI</b>
<b>Figures</b> .....	<b>VII</b>
<b>1. Hardware Configuration</b> .....	<b>2</b>
1.1 Introduction .....	2
<b>Single P2P Bridge</b> .....	<b>3</b>
1.2 Specifications .....	4
1.3 Jumpers and Switches .....	7
1.3.1 Jumper Setting .....	7
1.3.2 Clear CMOS (JP4).....	9
1.3.3 Switch Setting .....	10
1.4 Connector Setting .....	12
1.5 Safety Precautions .....	12
1.6 Installing the CPU and Heatsink.....	13
1.7 Software Support .....	14
<b>2. AWARD BIOS Setup</b> .....	<b>16</b>
2.1 Entering Setup.....	16
2.1.1 Standard CMOS Setup .....	17
2.1.2 Advanced BIOS Features Setup.....	17
2.1.3 Advanced Chipset Features Setup.....	21
2.1.4 Integrated Peripherals .....	24
2.1.5 Power Management Setup .....	27

2.1.6 PNP/PCI Configuration Setup .....	27
2.1.7 PC Health Status.....	29
2.1.8 Load Optimized Defaults .....	30
2.1.9 Set Password.....	30
2.1.10 Save and Exit Setup .....	30
2.1.11 Exit Without Saving .....	30
<b>Appendix A Pin Assignments .....</b>	<b>32</b>
A.1 J1 Connector .....	32
A.2 J2 Connector .....	33
A.3 J3 Connector .....	34
A.4 J5 Connector .....	35
A.5~A.7 On board jumpers and connectors .....	36
A.8~A11 On board jumpers and connectors .....	34
A.12~A16 On board jumper and connectors .....	35

# Tables

Table 1-1	MIC-3359 jumper descriptions.....	7
Table 1-2	MIC-3359 switch descriptions.....	7
Table 1-3	JP2 jumper definition .....	7
Table 1-4	JP3 jumper definition .....	8
Table 1-5	JP5 jumper definition .....	8
Table 1-6	JP7 jumper definition .....	8
Table 1-7	JP8 jumper definition .....	9
Table 1-8	JP4 definition .....	9
Table 1-9	SW1 & SW3 definition .....	10
Table 1-10	SW2 definition.....	10
Table 1-11	MIC-3359 connector descriptions .....	12
Table A. 1	J1 connector .....	32
Table A. 2	J2 connector .....	33
Table A. 3	J3 connector .....	34
Table A. 4	J5 connector .....	35
Tables A. 5 ~ A. 7	On board jumpers and connectors .....	36
Tables A. 8 ~ A.11	On board jumpers and connectors .....	37
Tables A.12 ~ A.16	On board jumpers and connectors.....	38

# Figures

Figure 1-1	MIC-3359 functional block diagram.....	6
Figure 1-2	MIC-3359 jumper, switch and connector locations.....	11
Figure 1-3	Complete assembly CPU and heatsink.....	14
Figure 2-1	Setup program initial screen.....	16
Figure 2-2	Standard CMOS setup screen.....	17
Figure 2-3	Advanced BIOS features setup screen.....	18
Figure 2-4	Advanced Chipset features setup screen.....	21
Figure 2-5	Integrated Peripherals setup screen.....	24
Figure 2-6	Power management setup screen.....	27
Figure 2-7	PNP/PCI configuration screen.....	28
Figure 2-8	PC Health setup screen.....	29



**Chapter 1**

**Hardware Configuration**

# 1. Hardware Configuration

## 1.1 Introduction

The MIC-3359 is a 6U 8HP CompactPCI® SBC ideal for mission critical, demanding industrial or military applications which require high performance as well as endurance in harsh operating environments.

The MIC-3359 CompactPCI® CPU board is optimized for Intel® 845GV chipset. It supports both the Intel Desktop Celeron® and Pentium® 4 processor up to 2.8 GHz, and the mobile Pentium® 4 -M processor. The VGA is integrated in the Intel® 845GV chipset, and there are two DDR DIMM slots which can support system memory up to 2GB. The MIC-3359 uses the Intel 82562ET for 10/100 Mb Fast Ethernet, with an option for the Intel® 82551ER for 10/100 Mb Fast Ethernet which is pin-to-pin compatible with the Intel® 82540EM for Giga Ethernet. The Pericom PI7C8150MA MHz PCI-to-PCI Bridge is designed for bus expansions, programmable data transfer rate control, and frequency conversions.

To achieve the most cost effective combination for entry-level CT applications or entry to mid-level industrial applications, you can use a MIC-3041L enclosure with a MIC-3359 6U CPCI board and Intel Pentium IV processor without a rear I/O transition board. This gives the best performance-price balance and produces the most cost-effective solution.

### **High Performance Intel® Pentium® 4 Processor-M, Intel® Desktop Pentium® 4 Processor, and Celeron® Processor**

The MIC-3359 supports the Intel® Pentium® 4 processor-M 1.7 GHz and 2.2 GHz, the Desktop Pentium® 4 Processor, and the Celeron® Processor with either u-FCPGA package or u-FCBGA package. Both Intel® Pentium® processor-M and Intel® Pentium® processor have on-chip 512 KB L2 cache providing high performance. The Intel® Celeron® processor has an on-chip 256KB L2 cache providing high performance. With the support of a 400 MHz and 533 MHz front-side bus, the MIC-3359 can fulfill customer's expectations of price-performance computing capability.

### **Compact Mechanical Design**

The MIC-3359 has a CPU heatsink specially designed for the mobile Intel® Pentium® 4-M and Intel® Pentium®4 processor, enabling the MIC-3359 to operate without a cooling fan on the heat sink. It needs only cooled air from the chassis fans for ventilation.

### **Single P2P Bridge**

The MIC uses the Pericom PI7C8150MA MHz PCI-to-PCI Bridge, which designed for bus expansions, programmable data transfer rate control, and frequency conversions. The Pericom Bridge can drive up to seven PCI slots in master mode, including those using bus master cards. Up to eight MIC-3359 units can be installed in one enclosure.

### **Complete I/O Functions**

The MIC-3359 offers all the I/O functions of an industrial computer with the rugged Euroboard form factor. Output cables are fully connected to the rear I/O module via user-define connectors (J3 and J5) on the backplane. The I/O panel contains two 10/100 base Ethernet ports (one of them is optional ), two COM ports, two USB 2.0 ports, one VGA connector, one PS/2 keyboard port, one PS/2 mouse port, and one parallel port. The front panel also has a reset button and LEDs for power status and HDD operation. The built-in high speed IDE controller provides two separate IDE channels with Ultra DMA/33/66/100 mode. One is for CF on board, and the other one is for IDE devices. The user-defined J3 connector is designed to support one IDE device, one floppy drive, one printer device, and one or two Ethernet networks. These drives can simply be connected to the backplane or to the rear transition board for easy service and maintenance.

## 1.2 Specifications

### Standard SBC Functions

#### • CompactPCI Bus Interface

PICMG 2.0 Rev. 3.0 compatible, 5V signaling; 32 bit/33 MHz, REQ/GNT for 7 slots;  
Operates in system slot as system master

#### • CPU: Intel® Pentium® 4 / Intel® Celeron®, 478-pin package FC-PGA

Mobile Pentium 4 Processor-M from 1.2 GHz up to 2.2 GHz for low power dissipation (higher frequencies on request), Desktop Pentium 4 from 2 GHz up to 2.8 GHz for high performance, 512 KB full speed L2 on-die cache, 400 MHz and 533 MHz processor front-side bus, passive heat sink for the processor, at least 300 LFM forced air cooling required in the chassis.

#### • BIOS: 4 Mb Firmware Hub (FWH) using Award BIOS

#### • Chipset: Intel® 845GV/ICH4 Chipset

Host Interface Support for Intel processor in an mPGA478 package

Hyper-Threading Technology support

Support Hub Interface 1.5 (266 MB/s point-to-point Hub Interface to the ICH4)

Integrated Graphics, core frequency of 200 MHz, resolution up to 2048 x 1536 x 60Hz x 8 bit, shared memory up to 64MB

#### • Front Side Bus: 400MHz/533 MHz (Intel® Pentium® 4 processor-M Processor)

#### • Bus Interface: 32-bit/33 MHz, PICMG 2.16 compliant

#### • Memory: Double Data Rate (DDR) SDRAM Configuration

Up to 2.0 GB of 200 MHz or 266 MHz DDR SDRAM

Two DDR DIMMs, single-sided and/or double-sided, DDR 200/266 unregistered, 184-pin non-ECC DDR

• **Ethernet:** the MIC-3359 uses the Intel® 82562ET LAN chip for 10/100 Mb Fast Ethernet, with an option for the Intel® 82551ER 10/100 Mb for Fast Ethernet which is pin-to-pin compatible with the Intel® 82540EM 10/100/1000 Mb for Giga Ethernet. MIC-3359 supports one 10/100Mb LAN; MIC-3359-A supports two 10/100Mb LANs; MIC-3359-B supports one 10/100Mb LAN, and one Gb LAN.

• **Enhanced IDE interface:** The IDE interface supports two channels. The master for the primary channel is reserved for the Compact Flash. The secondary IDE channel can be connected to a RIO module via the J3 connector. The interface supports PIO mode 4 and ATA 33/66/100 mode.

- **Serial ports:** COM1 and COM2 port (support RS-232/422/485 interface)
- **USB port:** Supports up to six USB channels: two front, two rear, and two on board for internal devices; USB specification 2.0/1.1 compatible
- **CompactFlash® socket:** one CompactFlash® type II socket on board.
- **AC97' Audio Interface:** Mic-in, Line-in, Line-out
- **LEDs:** Indicate LAN activity and speed, one green LED for power status, one yellow LED for IDE HDD status.
- **FDD Connector**
- **Parallel Port**
- **PS/2 Port:** One for keyboard and one for mouse
- **Watchdog timer:** Provides system reset, interrupt and NMI support via software control. Time interval is from 1 to 255 seconds.

**Functional Block Diagram**

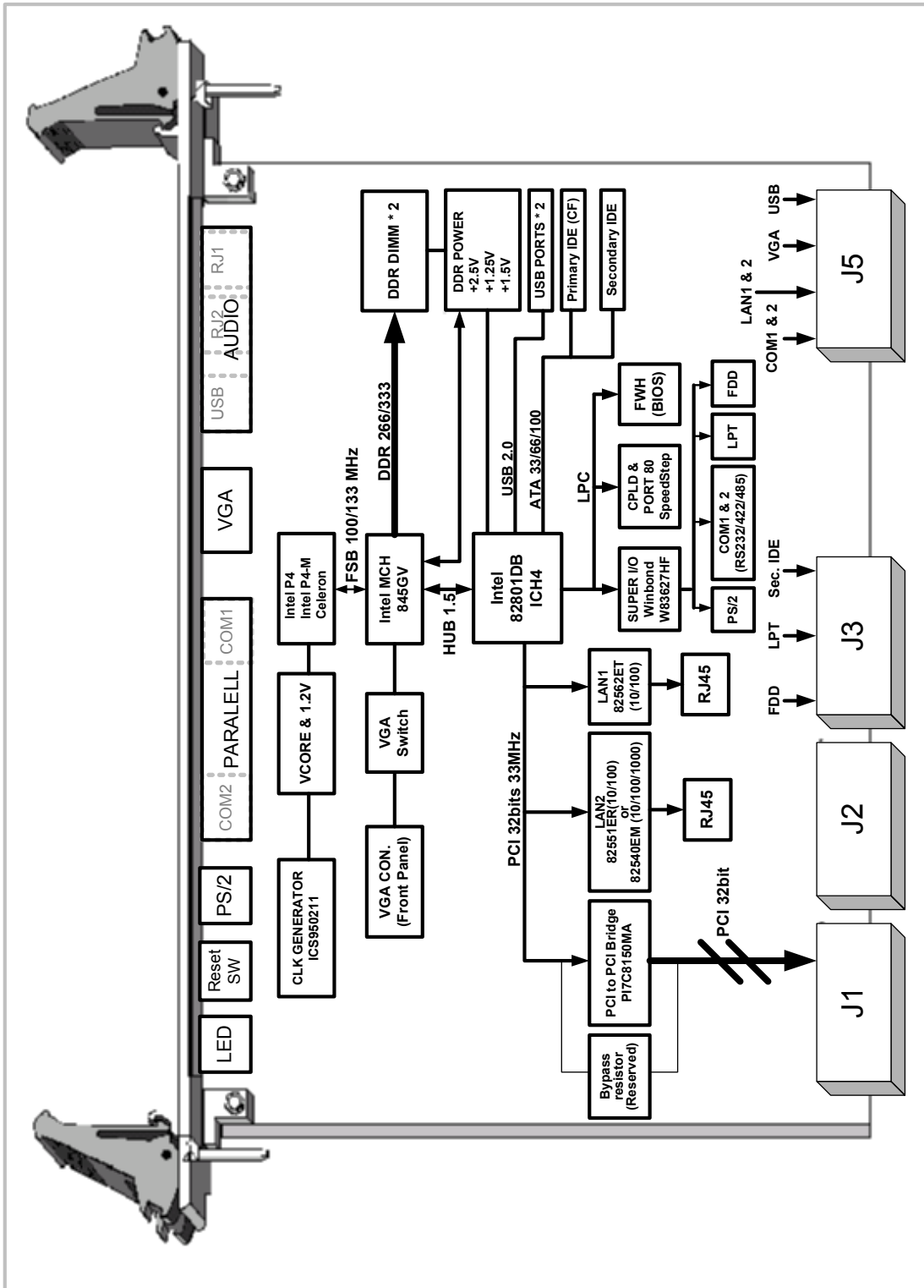

Figure 1-1 MIC-3359 functional block diagram

## 1.3 Jumpers and Switches

Table 1-1 and Table 1-2 list the jumper and switch functions. Figure 1-2 illustrates the jumper and switch locations. Read this section carefully before changing the jumper and switch settings on your MIC-3359 board.

Table 1-1 MIC-3359 jumper descriptions

Number	Function
JP2	VGA Output Setting
JP3	CPU Speed Setting
JP4	Clear CMOS
JP5	CF Mode Setting
JP7	COM2 Setting
JP8	COM1 Setting

Table 1-2 MIC-3359 switch descriptions

Number	Function
SW1 & SW3	CPU setting
SW2	Reset Button

### 1.3.1 Jumper Settings

Table 1-3 JP2 jumper definition

JP2 - VGA Output Settings		
Default	Front Panel	
	Rear I/O	

Table 1-4 JP3 jumper definitions

JP3 - CPU Speed Settings		
Default	CPU Select	
	100MHz	
	133MHz	

Table 1-5 JP5 jumper definition

JP5 - CF Mode Settings		
Default	Master	
	Slave	

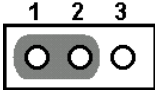
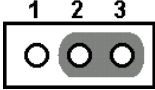
Table 1-6 JP7 jumper definition

JP7 - COM2 Settings			
Default	RS232	RS422	RS485



Table 1-7 JP8 jumper definition

JP8 – COM1 Settings			
Default	RS232	RS422	RS485

### 1.3.2 Clear CMOS (JP4)

This jumper is used to erase CMOS data and reset the system BIOS information. Follow the procedures below to clear the CMOS.

- 1、 Turn off the system.
- 2、 Close jumper JP4 (2-3) for about 3 seconds.
- 3、 Set jumper JP4 as Normal.
- 4、 Turn on the system. The BIOS is reset to its default setting.

Table 1-8 JP4 definition

JP4 – Clear CMOS		
Default	Normal	
	Clear CMOS	

### 1.3.3 Switch Settings

Table 1-9 SW1 &amp; SW3 definition

SW1 & SW3 – CPU Settings					
Default	<table border="0"> <tr> <td style="text-align: center;">SW3</td> <td style="text-align: center;">SW1</td> </tr> <tr> <td style="text-align: center;">  </td> <td style="text-align: center;">  </td> </tr> </table>	SW3	SW1		
SW3	SW1				
					
P4-M	<table border="0"> <tr> <td style="text-align: center;">SW3</td> <td style="text-align: center;">SW1</td> </tr> <tr> <td style="text-align: center;">  </td> <td style="text-align: center;">  </td> </tr> </table>	SW3	SW1		
SW3	SW1				
					

Table 1-10 SW2 definition

SW2 – Reset Button	
PUSH	Reset System

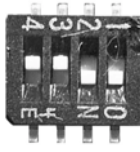
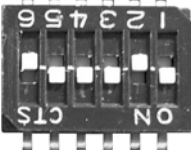
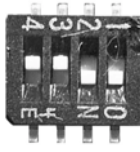
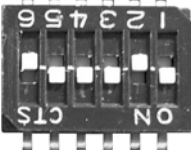
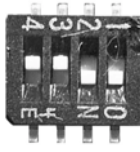
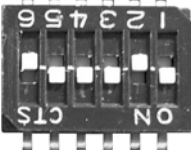
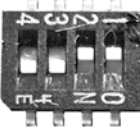
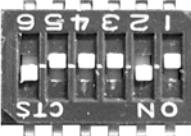
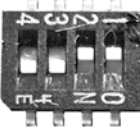
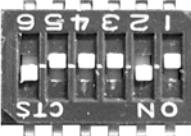
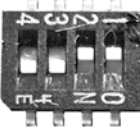
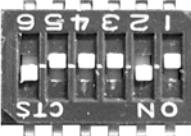
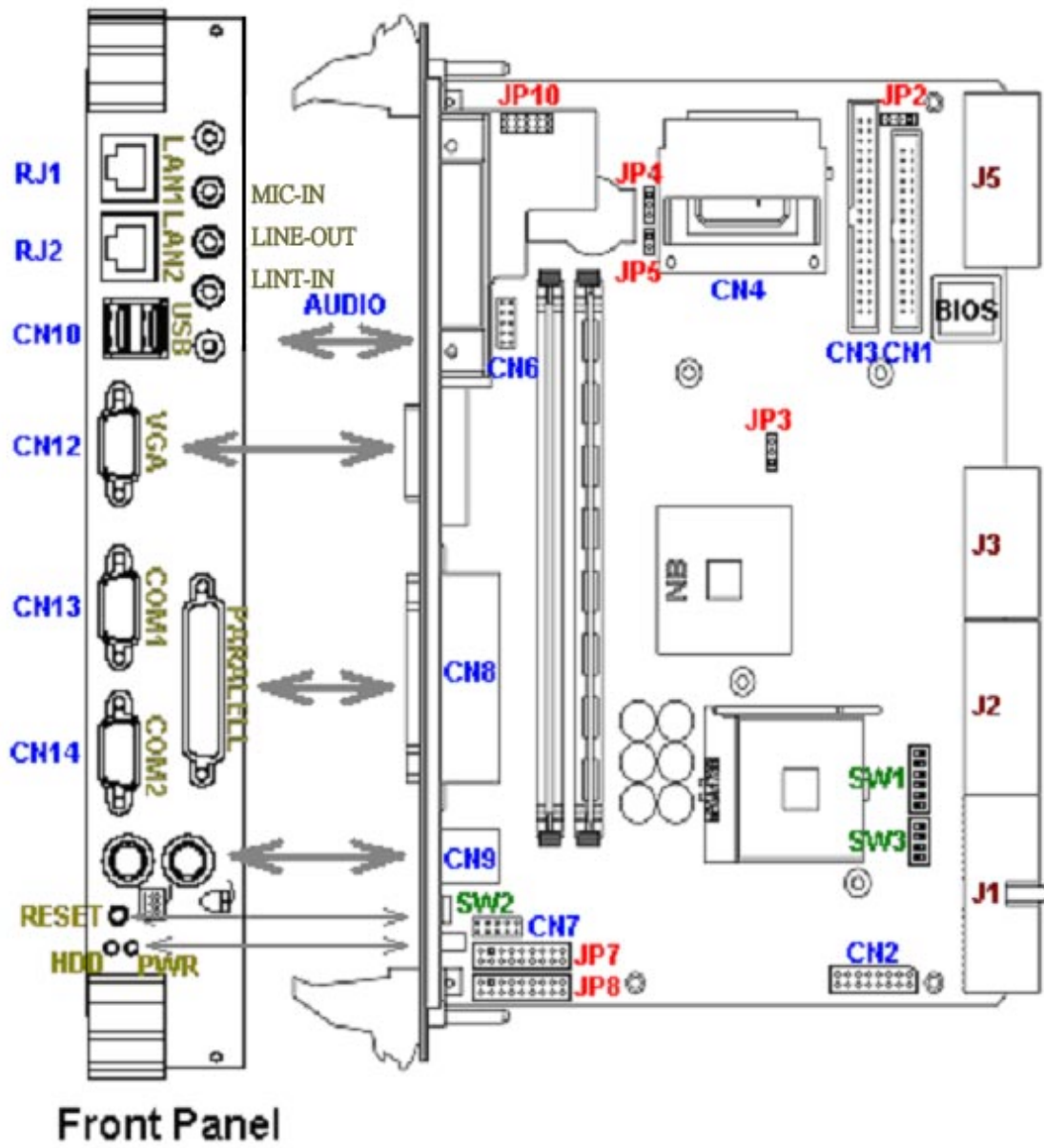

Figure 1-2 MIC-3359 jumper, switch, and connector locations

## 1.4 Connector Setting

On-board connectors link to external devices such as hard disk drives, keyboards, or floppy drives, etc. Table 1-11 lists the function of each connector and Figure 1-2 illustrates each connector location.

Table 1-11 MIC-3359 connector descriptions

Number	Function
CN1	FDD Connector
CN2	V(I/O) Setting
CN3	IDE Connector (Secondary IDE)
CN4	CompactFlash™ Connector (Primary IDE)
CN6	USB Port (Internal)
CN7	Internal COM2 Connector
CN8	LPT Connector
CN9	PS/2 Mouse/Keyboard Connector
CN10	USB Port*2
CN12	VGA Connector
CN13	COM1 Connector
CN14	COM2 Connector
JP10	AC'97 Connector
RJ1	LAN1 Connector
RJ2	LAN2 Connector (82551ER)
RJ2	LAN2 Connector (82540EM)
J1/J2	Primary CompactPCI® bus
J3/J5	Rear I/O transition
LED	IDE LED and Power LED

## 1.5 Safety Precautions

Follow these simple precautions to protect yourself from harm and the products from damage.

- 1、 To avoid electric shock, always disconnect the power from your PC chassis before you work on it. Don't touch any components on the CPU board or other boards while the PC is on.
- 2、 Disconnect power before making any configuration changes. The sudden rush

of power as you connect a jumper or install a board may damage sensitive electronic components.

3. Always ground yourself to remove any static charge before you touch your CPU board. Be particularly careful not to touch the chip connectors.  
Modern integrated electronic devices, especially CPUs and memory chips, are extremely sensitive to static electric discharges and fields. Keep the board in its antistatic packaging when it is not installed in the PC, and place it on a static dissipative mat when you are working with it. Wear a grounding wrist strap for continuous protection.

## 1.6 Installing CPU and Heatsink

The MIC-3359 supports the Intel® Pentium-4, the 478-pin package FCPGA, and the Mobile Pentium-4 Processor. In order to meet critical environmental conditions and size limitations, Advantech designed a heat sink to fulfill the primary requirements of the MIC-3359. Please refer to Figure 1-3 for an illustration of the heat-sink and thermal pad used for the MIC-3359.

The MIC-3359 should be fastened to a heat sink supporting Intel Pentium 4 in the factory. When the user installs the CPU, the following steps should be followed:

1. Remove the screws from the solder side cover. During this step, the front panel should also become loose. Be careful about any improper disassembly procedure that could cause any damage of SBC.
2. Remove the last four screws from the heat-sink, and then loosen the heat sink for CPU installation. Apply the silicone heat sink compound, found in the accessory bag, to the CPU.
3. Follow the reverse procedure to replace the heat-sink and solder side cover.

***Note: If you use a Mobile Pentium 4 processor, please don't use the silicone heat sink compound. You need to insert a heat pad between the processor and the heat-sink. The heat pad is in the accessory bag. The heat pad should be positioned between the heat-sink and the CPU. It is fragile, so please be careful during disassembly. If you are using a heat pad other than the one issued by Advantech, be aware that it may not absorb a sufficient amount of heat.***

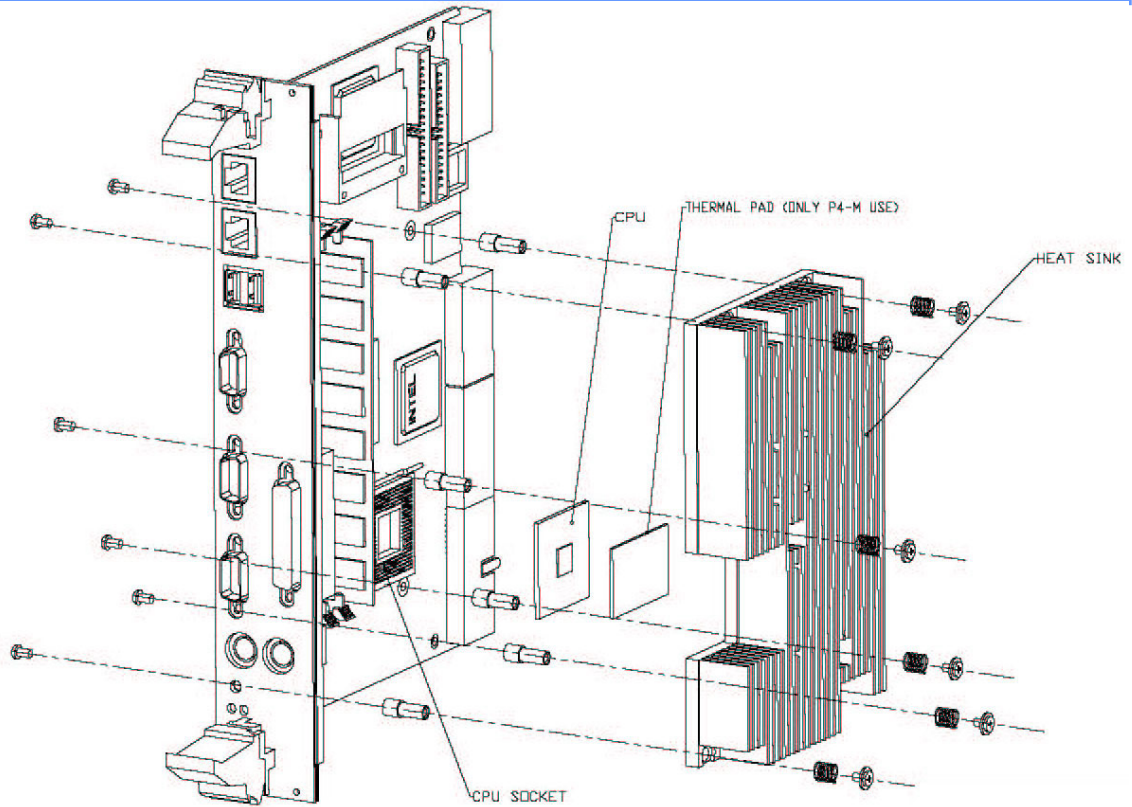

Figure 1-3 Complete assembly of CPU and heat sink

## 1.7 Software Support

Windows® XP/2000/NT 4.0, Red Hat Linux 9.0,

**Chapter 2**

**AWARD BIOS Setup**

## 2. AWARD BIOS Setup

Once you enter Award® BIOS CMOS Setup Utility, the Main Menu (Figure 2-1) will appear on the screen. The Main Menu allows you to select from nine setup functions and two exit choices. Use arrow keys to select among the items and press <Enter> to accept or enter the sub-menu.

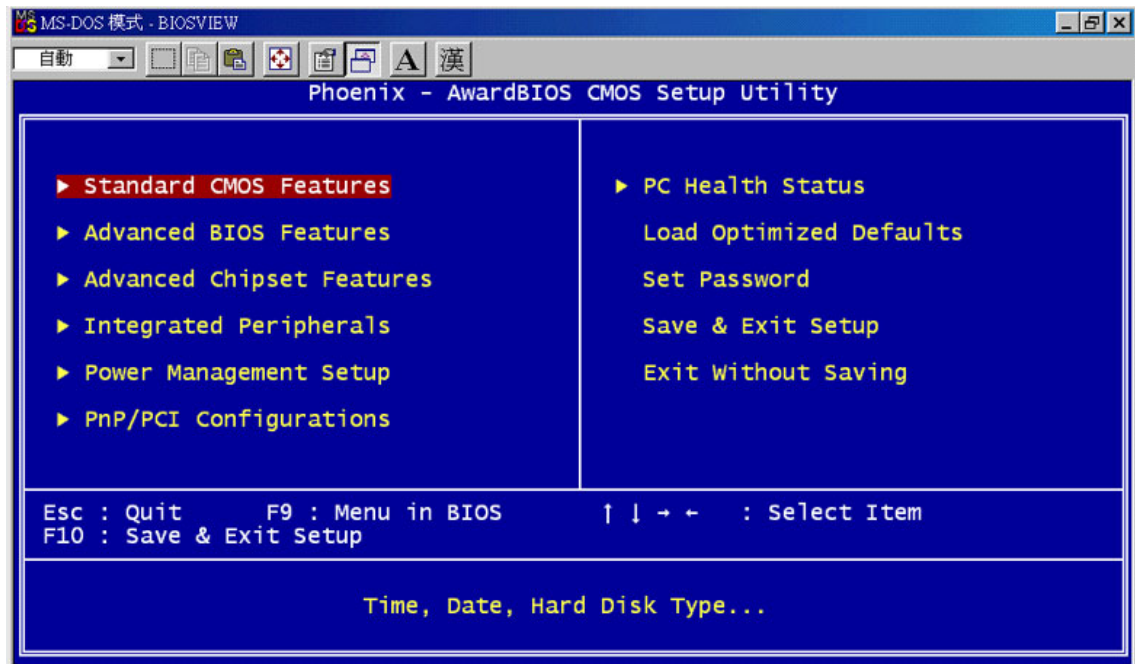

Figure 2-1 Setup program initial screen

Award's BIOS ROM has a built-in Setup program that allows users to modify the basic system configuration. This type of information is stored in battery-backed up CMOS so it retains the Setup information when the power is turned off.

### 2.1 Entering Setup

Turn on the computer and check for the "patch" code. If there is a number assigned to the patch code, it means that BIOS supports your CPU. If there is no number assigned to the patch code, please contact an Advantech application engineer to obtain an up-to-date patch code file. This will ensure that your CPU's system status is valid. After ensuring that you have a number assigned to the patch code, press <DEL> and you will immediately be allowed to enter Setup.



### 2.1.1 Standard CMOS Setup

The items in Standard CMOS Setup Menu are divided into 11 categories. Each category includes one or more setup items, or none. Use the arrow keys to highlight the item and then use the <PgUp> or <PgDn> keys to select the value you want for each item.

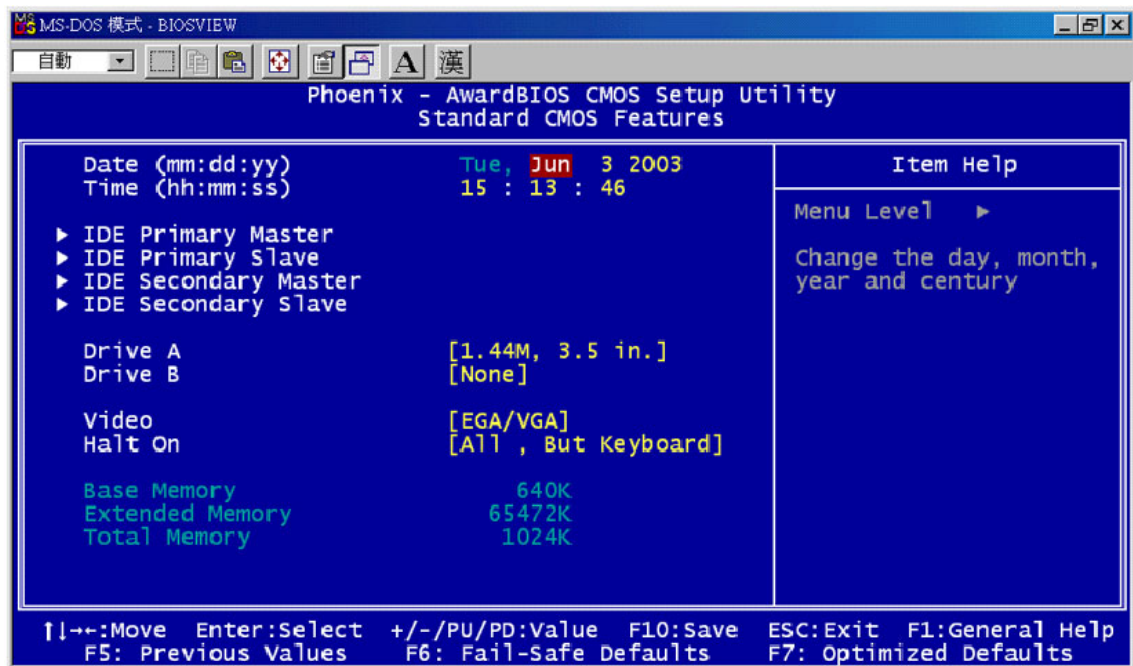

Figure 2-2 Standard CMOS setup screen.

Primary Master/Primary Slave/Secondary Master/Secondary Slave: Press PgUp/<+> or PgDn/<-> to select Manual, None, Auto type. Note that the specifications of your drive must match with the drive table. The hard disk will not work properly if you enter improper information for this category. If your hard disk drive type is not matched or listed, you can use Manual to define your own drive type manually. If you select Manual, the system will prompt for related information for the following items. Enter the information directly from the keyboard. This information should be provided in the documentation from your hard disk vendor or the system manufacturer.

### 2.1.2 Advanced BIOS Features Setup

The "Advanced BIOS FEATURES" screen will appear after the BIOS FEATURES SETUP item from the CMOS SETUP UTILITY Menu was chosen. This screen allows the user to

configure the board according to his particular requirements. Below are some major items that are provided in the BIOS FEATURES SETUP screen:

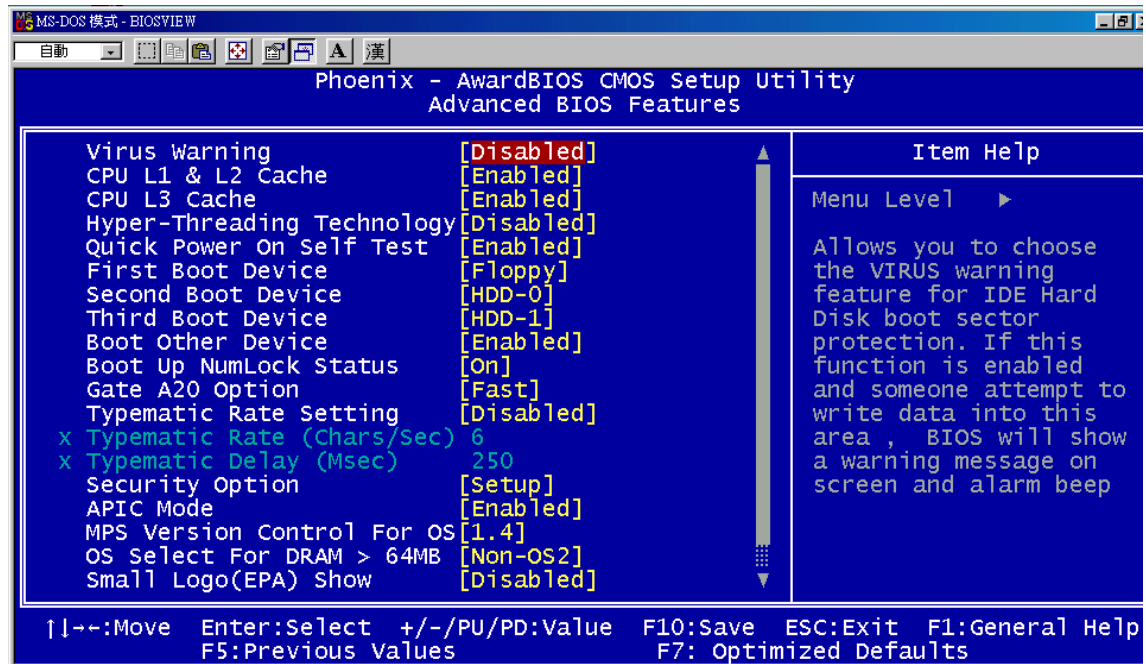

Figure 2-3 Advanced BIOS features setup screen

### **Virus Warning**

During and after the system boot, any attempt to write to the boot sector or partition table of the hard disk drive will halt the system. If this happens, a warning message will be displayed. You can run the anti-virus program to locate the problem. If Virus Warning is disabled, no warning message will appear if anything attempts to access the boot sector or hard disk partition.

### **CPU L1 & L2 Cache**

Default	Enabled	Enable cache
	Disabled	Disable cache

*Note: The internal cache is built into the processor.*

### **Quick Power On Self Test**

This category shortens the Power On Self Test (POST) after you power on the computer. If this is set to Enabled, BIOS will shorten or skip some check items during POST.

Default	Enabled	Enable quick POST
	Disabled	Normal POST

### **First/Second/Third Boot Device and Boot Other Device**

The BIOS attempts to load the operating system from the devices in the sequence selected in these items. The settings are Floppy, LS120, HDD-0, SCSI, CDROM, HDD-1, HDD-2, HDD-3, ZIP100, USB-FDD, USB-ZIP, USB-CDROM, USB-HDD, LAN and Disabled.

Default	First boot device	CDROM
	Second boot device	HDD-0
	Third boot device	HDD-1

*NOTE: When you boot by USB CD-ROM, please install WinXP with SP1 or Win 2000 with SP3.*

### **Boot Up NumLock Status**

Default	On	Keypad: numeric keys
	Off	Keypad: arrow keys

### **Gate A20 Option**

Default	Fast	The A20 signal is controlled by port 92 or chipset specific method.
	Normal	The A20 signal is controlled by keyboard controller or chipset hardware.

### **Typematic Rate Setting**

Key strokes repeat at a rate determined by the keyboard controller. When enabled, the typematic rate and typematic delay can be selected. The settings are: Enabled/Disabled. The default setting is Disabled.

### **Typematic Rate (Chars/Sec)**

Set the number of times a second to repeat a key stroke when you hold the key down. The settings are: 6, 8, 10, 12, 15, 20, 24, 30.

### **Typematic Delay (Msec)**

Sets the delay time after the key is held down before it begins to repeat the keystroke. The settings are: 250, 500, 750, 1000.

### **Security Option**

This category allows you to limit access to the system and/or to Setup.

Default	Setup	The system will boot, but access to Setup will be denied if the correct password is not entered at the prompt.
	System	The system will not boot and access to Setup will be denied if the correct password is not entered at the prompt.

### **APIC Mode (Advanced Programmable Interrupt Controller)**

**Default is Enabled.**

### **MPS Version Control For OS**

The options include 1.1 and 1.4. The default setting is 1.4

### **OS Select For DRAM > 64MB**

Allows OS2® to be used with > 64 MB of DRAM. Settings are Non-OS/2 (default) and OS2. Set to OS/2 if using more than 64MB and running OS/2®.

### **Small Logo (EPA) show**

The default setting is Disabled.

### **Max Performance**

Default is Enabled.

## **2.1.3 Advanced Chipset Features Setup**

The Advanced Chipset Features Setup option is used to change the values in the chipset registers. These registers control most of the system options in the computer. Choose the "ADVANCED CHIPSET FEATURES" from the Main Menu and the following screen will appear.

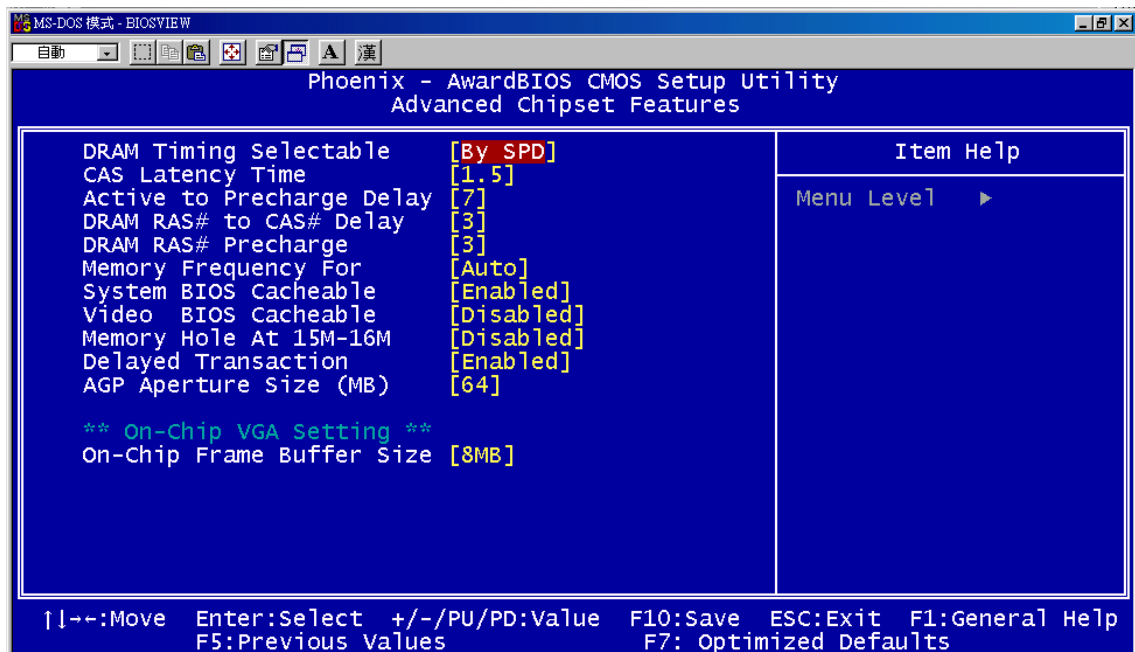

Figure 2-4 AdvancedS Chipset features setup screen

**DRAM Timing Selectable**

This field lets you select system memory timing data. Manual and BY SPD are two options. The default setting is BY SPD.

**CAS Latency Time**

When synchronous DRAM is installed, the number of clock cycles of CAS latency depends on the DRAM timing. The settings are: 1.5, 2 and 2.5.

**Active to Precharge Delay**

This field let you set Active to Precharge Delay. The settings are: 7, 6 and 5.

**DRAM RAS# to CAS# Delay**

This field lets you insert a timing delay between the CAS and RAS strobe signals, used when DRAM is written to, read from, or refreshed. Fast gives faster performance; and Slow gives more stable performance. This field applies only when synchronous DRAM is installed in the system. The settings are: 2 and 3.

**DRAM RAS# Precharge**

If an insufficient number of cycles are allowed for the RAS to accumulate its charge before DRAM refresh, the refresh may be incomplete and the DRAM may fail to retain data. Fast gives faster performance; and Slow gives more stable performance. This field applies only when synchronous DRAM is installed in the system. The settings are: 2 and 3.

**Memory Frequency For**

Default is Auto.

**System BIOS Cacheable**

Selecting Enabled allows caching of the system BIOS ROM at F0000h-FFFFFh, resulting in better system performance. However, if any program writes to this memory area, a system error may result. The settings are: Enabled (Default) and Disabled.

**Video BIOS Cacheable**

Select Enabled allows caching of the video BIOS, resulting in better system performance. However, if any program writes to this memory area, a system error may result. The settings are: Enabled and Disabled (Default).

**Memory Hole At 15M-16M**

You can reserve this area of system memory for ISA adapter ROM. When this area is reserved, it cannot be cached. The user information of peripherals that need to use this area of system memory usually discusses their memory requirements. The settings are: Enabled and Disabled (Default).

**Delayed Transaction**

The chipset has an embedded 32-bit posted write buffer to support delay transactions cycles. Select Enabled to support compliance with PCI specification version 2.1. The settings are: Enabled (Default) and Disabled.

**AGP Aperture Size (MB)**

This field lets you select the AGP aperture size. The settings are: 4, 8, 16, 32, 64, 128 and 256.

**On-Chip Frame Buffer Size (MB)**

This field let you select On-Chip buffer size. The settings are: 1 and 8.

## 2.1.4 Integrated Peripherals

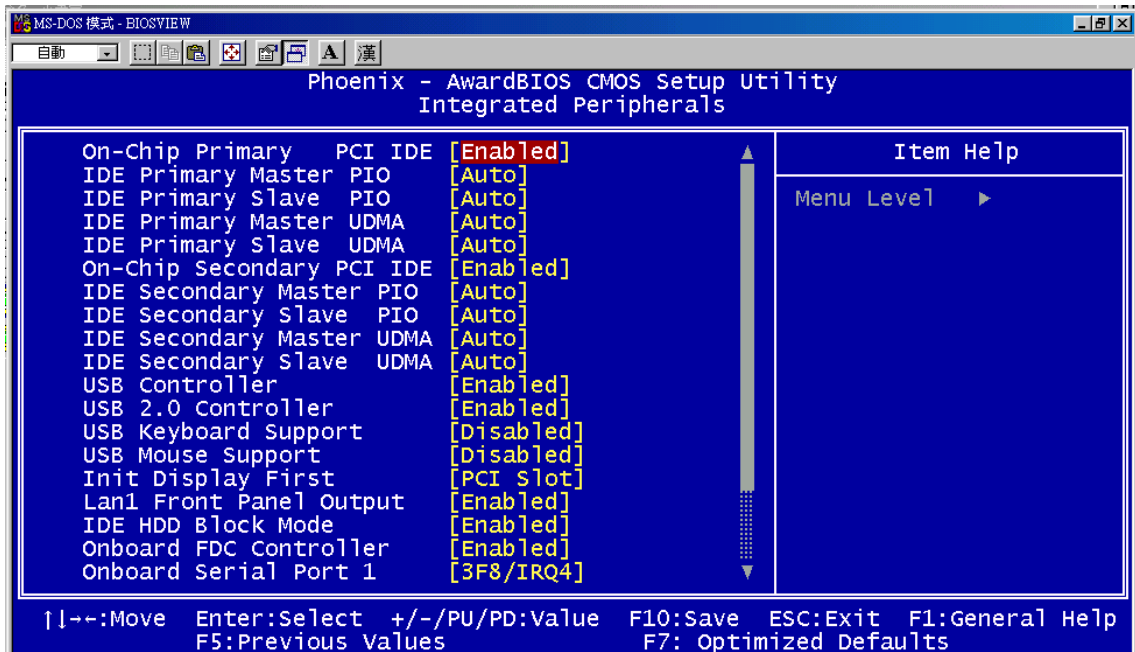

Figure 2-5 Integrated Peripherals setup screen

### **On-Chip Primary/Secondary PCI IDE**

The integrated peripheral controller contains an IDE interface with support for two IDE channels. Select Enabled to activate each channel separately. The settings are: Enabled (Default) and Disabled.

### **IDE Primary/Secondary Master/Slave PIO**

The four IDE PIO (Programmed Input/Output) fields let you set a PIO mode (1-4) for each of the four IDE devices that the onboard IDE interface supports. Modes 0 through 4 provide successively increased performance. In Auto mode, the system automatically determines the best mode for each device. The settings are: Auto (Default), Mode 0, Mode 1, Mode 2, Mode 3, Mode 4.

### **IDE Primary/Secondary Master/Slave UDMA**

Ultra DMA/33 implementation is possible only if your IDE hard drive supports it and the operating environment includes a DMA driver (Windows 95 OSR2 or a third-party



IDE bus master driver). If your hard drive and your system software both support Ultra DMA/33 and Ultra DMA/66 and Ultra DMA/100, select Auto to enable BIOS support. The settings are: Auto (Default), Disabled.

### **USB Controller**

Select Enabled if your system contains a Universal Serial Bus (USB) 1.1 controller. The settings are: Enabled (Default), Disabled.

### **USB 2.0 Controller**

Select Enabled if your system contains a Universal Serial Bus (USB) 1.1/2.0 controller. The settings are: Enabled (Default), Disabled.

### **USB Keyboard/Mouse Support**

Select Enabled if you use USB KB/Mouse in DOS mode. Default is Disabled.

### **AC 97 Audio**

Default is Auto.

### **Init Display First**

User can choose display priority on either peripheral PCI slot or on board VGA chip. There are 2 options: PCI slot (Default) and On board.

### **LAN1 Front Panel Controller**

The item allows you to choice LAN1 connective way. There are 3 options: Front (Default), 2.16 and Rear

### **IDE HDD Block Mode**

Block mode is also called block transfer, multiple commands, or multiple sector

read/write. If your IDE hard drive supports block mode (most new drives do), select Enabled for automatic detection of the optimal number of block read/writes per sector the drive can support. The settings are: Enabled (Default), Disabled.

### **Onboard FDC Controller**

Select Enabled if your system has a floppy disk controller (FDD) installed on the system board and you wish to use it. If you install add-on FDC or the system has no floppy drive, select Disabled in this field. The settings are: Enabled (Default) and Disabled.

### **Onboard Serial Port 1/Port 2**

Select an address and corresponding interrupt for the first and second serial ports. The Serial Port 1 settings are: 3F8/IRQ4 (Default), 2F8/IRQ3, 3E8/IRQ4, 2E8/IRQ3, Disabled, Auto. The Serial Port 2 settings are: 3F8/IRQ4, 2F8/IRQ3 (Default), 3E8/IRQ4, 2E8/IRQ3, Disabled, Auto.

### **Onboard Parallel Port**

There is a built-in parallel port on the on-board Super I/O chipset that provides Standard, ECP, and EPP features. It has the following options: Disabled, 378/IRQ7 (Default), 278/IRQ5, 3BC/IRQ7 and Disabled.

### **Parallel Port Mode**

Default	Spp	Standard Parallel Port
	EPP1.9+SPP	Support both the SPP and EPP1.9 modes.
	ECP	Extended Capability Port

### **EPP Mode Select**

Default is EPP 1.7.

## **ECP Mode Use DMA**

The options: 1 and 3 (Default)

### **2.1.5 Power Management Setup**

The Power Management Setup allows you to configure you system to most effectively save energy while operating in a manner consistent with your own style of computer use.

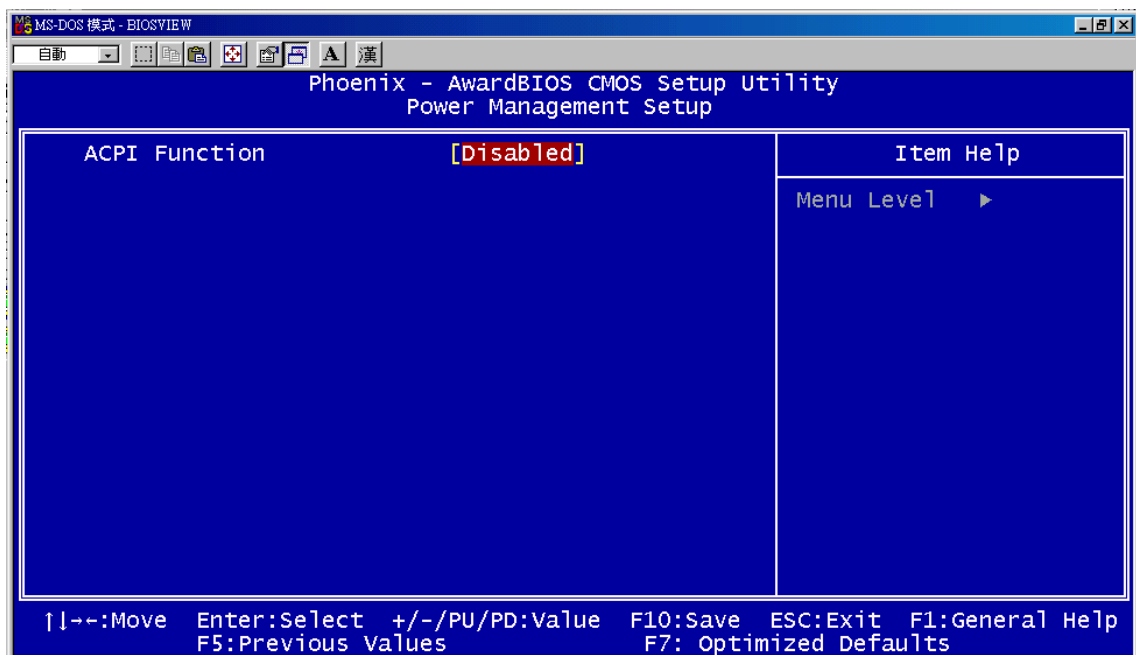

Figure 2-6 Power management setup screen

#### **ACPI Function**

This category allows you to select ACPI power management effective or not. The options: Enabled and Disabled (Default).

### **2.1.6 PNP/PCI Configuration Setup**

This section describes configuring the PCI bus system. PCI, or Personal Computer Interconnect, is a system which allows I/O devices to operate at speeds nearing the

speed the CPU itself uses when communicating with its own special components. This section covers some very technical items and it is strongly recommended that only experienced users should make any changes to the default settings.

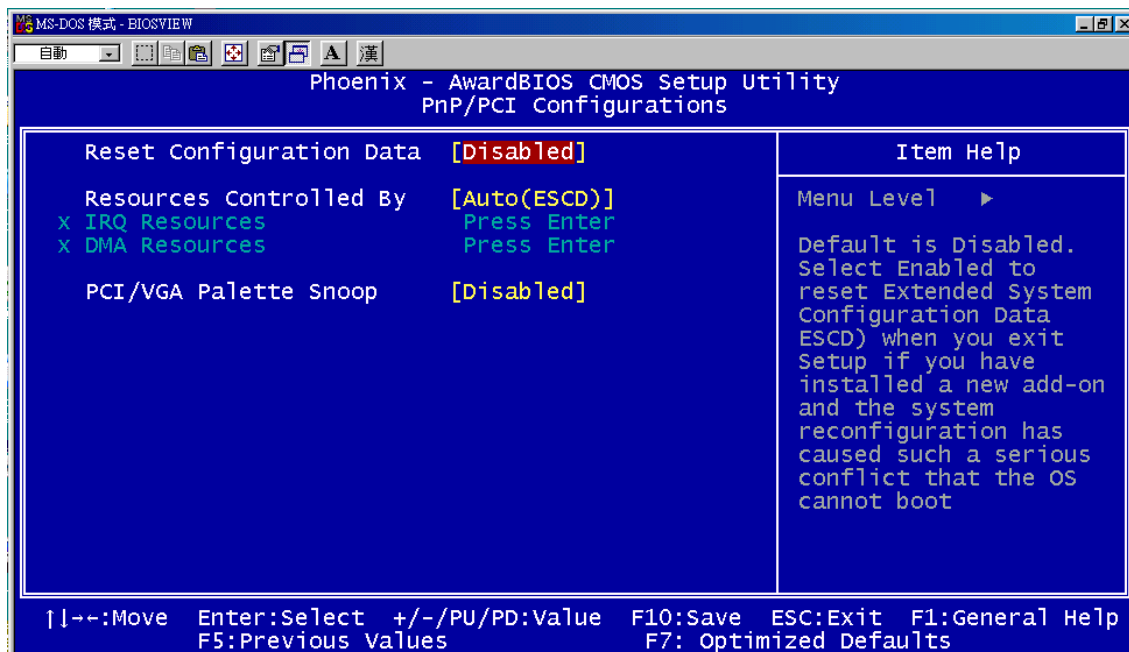

Figure 2-7 PNP/PCI configuration screen

### **Reset Configuration Data**

Normally, you leave this field Disabled. Select Enabled to reset Extended System Configuration Data (ESCD) when you exit Setup if you have installed a new add-on and the system reconfiguration has caused such a serious conflict that the operating system can not boot. The settings are: Enabled and Disabled (Default).

### **Resource Controlled By**

The Award Plug and Play BIOS has the capacity to automatically configure all the boot and Plug and Play compatible devices. However, this capability means absolutely nothing unless you are using a Plug and Play operating system such as Windows® 95/98. If you set this field to "manual," choose specific resources by going into each of the sub menus that follow this field (a sub menu is preceded by a "Y"). The settings are: Auto (ESCD) (Default), Manual.

### **IRQ Resources**

When resources are controlled manually, assign each system interrupt a type, depending on the type of device using the interrupt.

### **DMA Resources**

When resources are controlled manually, assign each system interrupt a type, depending on the type of device using the interrupt.

### **PCI/VGA Palette Snoop**

Leave this field at Disabled. The settings are Enabled, Disabled (Default).

## **2.1.7 PC Health Status**

This section shows the Status of the CPU, Fan, and gives a warning for overall system status. This is only available if there is a hardware monitor on board.

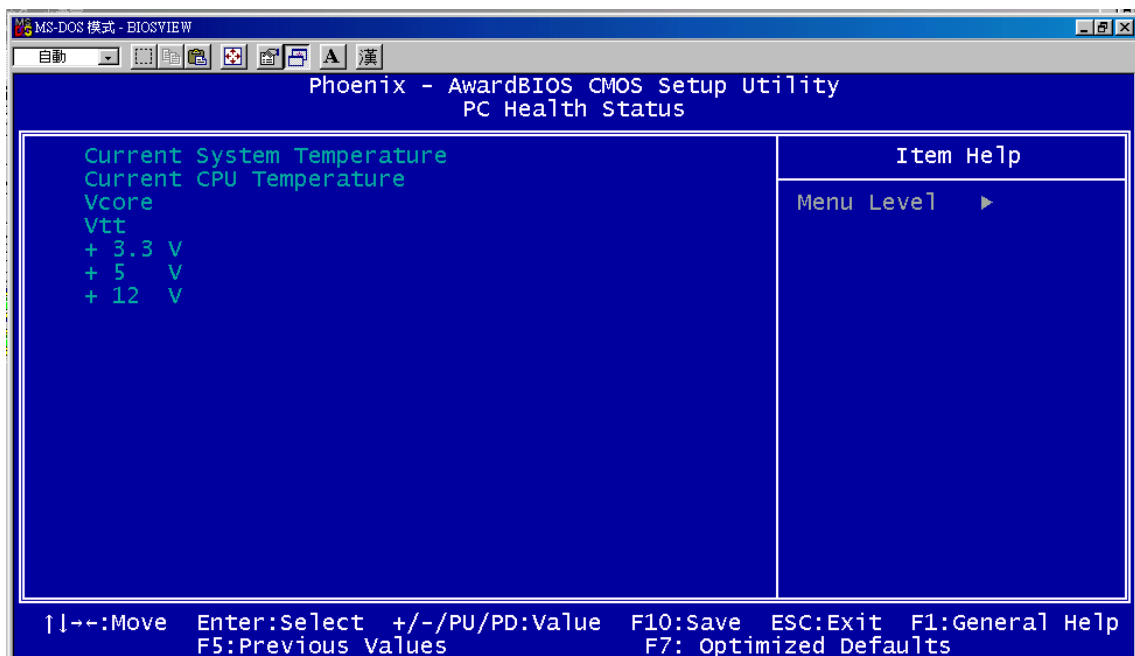

Figure 2-8 PC Health setup screen

**Current System Temp./ CPU Temp./ Vcore/ Vtt/ +3.3V/ +5V/ +12V**

This screen shows system health status.

**2.1.8 Load Optimized Defaults**

When you press <Enter> on this item, you get a confirmation dialog box with a message similar to:

**Load Optimized Defaults (Y/N) ? N**

Pressing 'Y' loads the default values that are factory settings for optimal performance system operations.

**2.1.9 Set Password**

To change, confirm, or disable the password, choose the "PASSWORD SETTING" option from the Setup main menu and press Enter. The password can be at most 8 characters long. Remember, to enable this feature. You must first select the Security Option in the Advance BIOS FEATURES SETUP to be either "Setup" or "System." Pressing Enter again without typing any characters can disable the password setting function.

**2.1.10 Save & Exit Setup**

If you select this and press the [Enter] key, the values entered in the setup utilities will be recorded in the CMOS memory of the chipset. The microprocessor will check this every time you turn your system on and compare this to what it finds as it checks the system. This record is required for the system to operate.

**2.1.11 Exit Without Saving**

Selecting this option and pressing the Enter key lets you exit the Setup program without recording any new values or changing old ones.

**Appendix** **A**

**Pin Assignments**

## Appendix A、 Pin Assignments

### A.1 J1 Connector

Table A. 1 J1 connector

J1 - CompactPCI I/O						
	Row A	Row B	Row C	Row D	Row E	Row F
1	+5V	-12V	TRST#	+12V	+5V	GND
2	TCK	+5V	TMS	NC	TDI	GND
3	INTA#	INTB#	INTC#	+5V	INTD#	GND
4	NC	HEALTHY#	V(I/O)	INTP	INTS	GND
5	NC	NC	PCI_RST#	GND	GNT0#	GND
6	REQ0#	PCI_PRESENT#	+3.3V	CLK0	AD31	GND
7	AD30	AD29	AD28	GND	AD27	GND
8	AD26	GND	V(I/O)	AD25	AD24	GND
9	C/BE3#	NC	AD23	GND	AD22	GND
10	AD21	GND	+3.3V	AD20	AD19	GND
11	AD18	AD17	AD16	GND	C/BE2#	GND
12						
13						GND
14						
15	+3.3V	FRAME#	IRDY#	BD_SEL#	TRDY#	GND
16	DEVSEL#	PCIXCAP	V(I/O)	STOP#	LOCK#	GND
17	+3.3V	IPMB_SCL	IPMB_SDA	GND	PERR#	GND
18	SERR#	GND	+3.3V	PAR	C/BE1#	GND
19	+3.3V	AD15	AD14	GND	AD13	GND
20	AD12	GND	V(I/O)	AD11	AD10	GND
21	+3.3V	AD9	AD8	M66EN	C/BE0#	GND
22	AD7	GND	+3.3V	AD6	AD5	GND
23	+3.3V	AD4	AD3	+5V	AD2	GND
24	AD1	+5V	V(I/O)	AD0	ACK64#	GND
25	+5V	REQ64#	ENUM#	+3.3V	+5V	GND

Note : NC → No Connect # → Active Low



## A.2 J2 Connector

Table A. 2 J2 connector

J2 - CompactPCI I/O						
	Row A	Row B	Row C	Row D	Row E	Row F
1	CLK1	GND	REQ1#	GNT1#	REQ2#	GND
2	CLK2	CLK3	SYSEN#	GNT2#	REQ3#	GND
3	CLK4	GND	GNT3#	REQ4#	GNT4#	GND
4	V(I/O)	NC	C/BE7#	GND	C/BE6#	GND
5	C/BE5#	GND	V(I/O)	C/BE4#	PAR64	GND
6	AD63	AD62	AD61	GND	AD60	GND
7	AD59	GND	V(I/O)	AD58	AD57	GND
8	AD56	AD55	AD54	GND	AD53	GND
9	AD52	GND	V(I/O)	AD51	AD50	GND
10	AD49	AD48	AD47	GND	AD46	GND
11	AD45	GND	V(I/O)	AD44	AD43	GND
12	AD42	AD41	AD40	GND	AD39	GND
13	AD38	GND	V(I/O)	AD37	AD36	GND
14	AD35	AD34	AD33	GND	AD32	GND
15	NC	GND	FAL#	REQ5#	GNT5#	GND
16	NC	NC	DEG#	GND	NC	GND
17	NC	GND	PRST#	REQ6#	GNT6#	GND
18	NC	NC	NC	GND	NC	GND
19	NC	GND	NC	NC	NC	GND
20	CLK5	NC	NC	GND	NC	GND
21	CLK6	GND	NC	NC	NC	GND
22	GA4	GA3	GA2	GA1	GA0	GND

Note : NC → No Connect                      # → Active Low

## A.3 J3 Connector

Table A. 3 J3 connector

<b>J3 - CompactPCI I/O (LPT, FDD, Secondary IDE)</b>						
	Row A	Row B	Row C	Row D	Row E	Row F
1	LPT_PD0	LPT_PD1	LPT_PD2	LPT_PD3	LPT_PD4	GND
2	LPT_PD5	LPT_PD6	LPT_PD7	LPT_BUSY	FDD_DRVEN1	GND
3	LPT_STB#	LPT_AFD#	FDD_DRVEN0	FDD_INDEX#	FDD_DSKCHG#	GND
4	LPT_ERR#	LPT_ACK#	FDD_RDATA#	FDD_WP#	FDD_TRACK0#	GND
5	LPT_PE	LPT_SLCT	FDD_STEP#	FDD_MTR0#	FDD_WD#	GND
6	LPT_SLIN#	LPT_INIT#	FDD_WE#	FDD_HEAD#	FDD_DSA#	GND
7	FDD_DIR#	SDDACK#	IDE_RESET#	SDIORDY	SDCS#1	GND
8	IRQ15	S66DET	SDA0	SDA1	SDA2	GND
9	SECHDDLED#	RIO_CLK	SDIOW#	SDDREQ	SDCS#3	GND
10	SDD15	SDD14	SDIOR#	SDD10	SDD11	GND
11	SDD5	SDD9	SDD13	SDD6	SDD8	GND
12	SDD1	SDD3	SDD12	SDD4	SDD7	GND
13	SDD0	SDD2	NC	NC	NC	GND
14	NC	NC	NC	NC	NC	GND
15	NC	NC	GND	NC	NC	GND
16	NC	NC	GND	NC	NC	GND
17	NC	NC	GND	NC	NC	GND
18	NC	NC	GND	NC	NC	GND
19	NC	NC	NC	NC	NC	GND

Note : NC → No Connect                      # → Active Low

## A.4 J5 Connector

Table A. 4 J5 connector

J5 - CompactPCI I/O (VGA, LAN, COM, USB, PS/2)						
	Row A	Row B	Row C	Row D	Row E	Row F
1	NC	NC	GND	NC	NC	GND
2	NC	NC	GND	NC	NC	GND
3	MDIB0+	MDIB0-	GND	MDIB1+	MDIB1-	GND
4	MDIB2+	MDIB2-	GND	MDIB3+	MDIB3-	GND
5	GND	GND	+3.3V	GND	GND	GND
6	NC	NC	LINK1000-2#	ACTLED-2#	+5V	GND
7	NC	NC	LINK100-2#	LNKLED-2#	+5V	GND
8	IO-NRX2	NC	IO-NTX2	IO-NRTS2	KBDAT	GND
9	2RXD232	RX2	IO-NDTR2	IO-NOTS2	KBCLK	GND
10	IO-NDCD2	NC	IO-NRI2	IO-NDSR2	MSDAT	GND
11	IO_SIN1	NCTS1	NC	NC	MSCLK	GND
12	IO_SOUT1	NDSR1	NC	LAN1-ACT-LED#	DDC_DAT	GND
13	NRTS1	IO_DTR#	NC	LAN1-LINK-LED#	DDC_CLK	GND
14	IO_DCD#	NRI1	NC	LAN1-SPD-LED#	GND	GND
15	USB_OC5#	NC	NC	GND	REAR_BLUE	GND
16	USB_OC4#	S_GNT7	GND	REAR_VSYNC	GND	GND
17	GND	S_REQ7	NC	GND	REAR_GREEN	GND
18	USB_P4+	GND	GND	REAR_HSYNC	GND	GND
19	USB_P4-	GND	USB_P5+	GND	REAR_RED	GND
20	GND	GND	USB_P5-	GND	GND	GND
21	NC	NC	GND	NC	NC	GND
22	LAN1RD+	LAN1RD-	GND	LAN1TD+	LAN1TD-	GND

Note : NC → No Connect # → Active Low

## A.5~A.7 On board Jumpers and Connectors

Table A.5 CN1 – FDD Connector

CN1 - FDD Connector			
1	GND	2	FDD_DRVEN0
3	GND	4	NC
5	NC	6	FDD_DRVEN1
7	GND	8	FDD_INDEX#
9	GND	10	FDD_MTR0#
11	GND	12	FDD_DSB#
13	GND	14	FDD_DSA#
15	GND	16	FDD_MOB#
17	GND	18	FDD_DIR#
19	GND	20	FDD_STEP#
21	GND	22	FDD_WD#
23	GND	24	FDD_WE#
25	GND	26	FDD_TRACK0#
27	GND	28	FDD_WP#
29	GND	30	FDD_RDATA#
31	GND	32	FDD_HEAD#
33	GND	34	FDD_DSKCHG#

Table A.6 CN2 – V (I/O) Setting

CN2 – V(I/O) Setting			
★	V(I/O) = +5V	Insert	
	V(I/O) = +3.3V	Remove	

Table A.7 CN3 – IDE Connector

CN3 - IDE Connector			
1	RESET#	2	GND
3	SDD7	4	SDD8
5	SDD6	6	SDD9
7	SDD5	8	SDD10
9	SDD4	10	SDD11
11	SDD3	12	SDD12
13	SDD2	14	SDD13
15	SDD1	16	SDD14
17	SDD0	18	SDD15
19	GND		
21	SDDREQ	22	GND
23	SDIOW#	24	GND
25	SDIOR#	26	GND
27	SDIORDY	28	CSEL
29	SDDACK#	30	GND
31	IRQ15	32	NC
33	SDA1	34	S66DET
35	SDA0	36	SDA2
37	SDCS#1	38	SDCS#3
39	SECHDDLED#	40	GND

**NC** : No Connect  
**#** : Active Low  
**★** : Default Setting

## A.8~A.11 On board Jumpers and Connectors

Table A.8 CN4 – CompactFlash

CN4 – CompactFlash			
1	GND	2	D3
3	D4	4	D5
5	D6	6	D7
7	CS1#	8	GND
9	GND	10	GND
11	GND	12	GND
13	+5V	14	GND
15	GND	16	GND
17	GND	18	A2
19	A1	20	A0
21	D0	22	D1
23	D2	24	NC
25	GND	26	GND
27	D11	28	D12
29	D13	30	D14
31	D15	32	CS3#
33	NC	34	IORD#
35	IOWR#	36	WE#
37	IRQ14	38	+5V
39	CSEL#	40	NC
41	RESET#	42	IORDY#
43	NC	44	REG#
45	DASP#	46	NC
47	D8	48	D9
49	D10	50	GND

Table A.9 CN6 – USB Port (Internal)

CN6 - USB Port (Internal)			
1	+5V	6	+5V
2	USBD3-	7	USBD2-
3	USBD3+	8	USBD2+
4	GND	9	GND
5	NC		

Table A.10 CN7 – Internal COM2

CN7 – Internal COM2			
1	DCD#	6	DSR#
2	SIN	7	RTS#
3	SOUT	8	CTS#
4	DTR#	9	RI#
5	GND		

Table A.11 CN8 – LPT Connector

CN8 - LPT Connector			
1	LPT_STB#	14	LPT_AFD#
2	LPT_PD0	15	LPT_ERR#
3	LPT_PD1	16	LPT_INIT#
4	LPT_PD2	17	LPT_SLIN#
5	LPT_PD3	18	GND
6	LPT_PD4	19	GND
7	LPT_PD5	20	GND
8	LPT_PD6	21	GND
9	LPT_PD7	22	GND
10	LPT_ACK#	23	GND
11	LPT_BUSY	24	GND
12	LPT_PE	25	GND
13	LPT_SLCT		

## A.12~A.16 On board Jump and Connector

Table A.12 CN9 – PS/2 Connector

CN9 - PS/2 Connector			
1	KBDATA	7	MSDATA
2	NC	8	NC
3	GND	9	GND
4	+5V	10	+5V
5	KBCLK	11	MSCLK
6	NC	12	NC

**NC** : No Connect

Table A.15 CN13, CN14 – COM1, COM2

CN13, CN14 - COM1, COM2			
1	DCD#	6	DSR#
2	SIN	7	RTS#
3	SOUT	8	CTS#
4	DTR#	9	RI#
5	GND		

Table A.13 CN10 – USB Port

CN10 - USB Port			
1	+5V	5	+5V
2	USB0-	6	USB1-
3	USB0+	7	USB1+
4	GND	8	GND

Table A.16 JP10 – AC`97 Connector

JP10 - AC`97 Connector			
1	AC97_SDIN0	2	AC97_SDOUT
3	AC97_SYNC	4	AC97_RST#
5	SPKR	6	GND
7	+5V	8	AC97_BITCLK
9	+5V	10	GND

**#** : Active Low

Table A.14 CN12 – VGA Connector

CN12 - VGA Connector			
1	RED	9	+5V
2	GREEN	10	GND
3	BLUE	11	NC
4	NC	12	DDC_DATA
5	GND	13	HSYNC
6	GND	14	VSYNC
7	GND	15	DDC_CLK
8	GND		

## A.17~A.19 On board Jumpers and Connectors

Table A.17 RJ1 – LAN1 Connector (LED)

RJ1 – LAN1 Connector			
1	TD+	7	RD+
2	TD-	8	RD-
3	NC	9	+3.3V
4	NC	10	SPEED_LED#
5	NC	11	LINK_LED#
6	NC	12	ACT_LED#

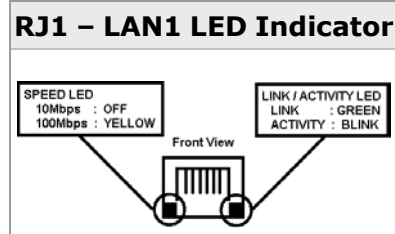

Table A.18 RJ2 – LAN2 Connector (82551ER)

RJ2 – LAN2 Connector (82551ER)			
1	D+	7	RD+
2	TD-	8	RD-
3	NC	9	+3.3V
4	NC	10	SPEED_LED#
5	NC	11	LINK_LED#
6	NC	12	ACT_LED#

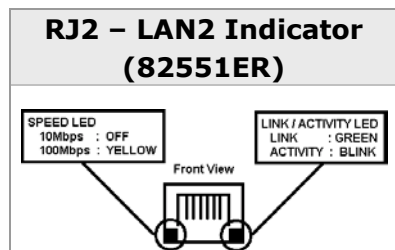

Table A.19 RJ2 – LAN2 Connector (82540em)

RJ2 – LAN2 Connector (82540EM)			
1	MDI_2+	8	MDI_1+
2	MDI_0+	9	MDI_1-
3	MDI_0-	10	MDI_3-
4	+2.5V	11	LINK1000#
5	MDI_2-	12	LINK100#
6	MDI_3+	13	LINK_LED#
7	+2.5V	14	ACT_LED#

