

MIC-3355

6u-sized Pentium® processor-based
CPU module for ***CompactPCI***®

Copyright Notice

This document is copyrighted, 1998. All rights are reserved. The original manufacturer reserves the right to make improvements to the products described in this manual at any time without notice.

No part of this manual may be reproduced, copied, translated or transmitted in any form or by any means without the prior written permission of the original manufacturer. Information provided in this manual is intended to be accurate and reliable. However, the original manufacturer assumes no responsibility for its use, nor for any infringements upon the rights of third parties which may result from its use.

Acknowledgements

AMD is a trademark of Advanced Micro Devices, Inc.

Award is a trademark of Award Software International, Inc.

Cyrix is a trademark of Cyrix Corporation.

IBM, PC/AT, PS/2 and VGA are trademarks of International Business Machines Corporation.

Intel and Pentium are trademarks of Intel Corporation.

Microsoft Windows® is a registered trademark of Microsoft Corp.

PICMG™, CompactPCI™ and the PICMG™, CompactPCI™ logos are trademarks of the PCI Industrial Computers Manufacturers Group

RTL is a trademark of Realtek Semi-Conductor Co., Ltd.

SiS is a trademark of Silicon Integration Systems Corporation.

All other product names or trademarks are properties of their respective owners.

Part No. 2006335520

Printed in Taiwan

3rd Edition

January 2000

Packing List

Before installing your board, ensure that the following materials have been received:

- 1 MIC-3355 all-in-one single board computer
- 1 CD-ROM disc including Ethernet utility programs, IDE utility programs and SVGA utility programs and drivers for Windows 3.1/95/NT and OS/2
- 1 hard disk drive (IDE) interface cable (44-pin)
- 1 warranty certificate
- This user's manual

If any of these items are missing or damaged, contact your distributor or sales representative immediately.

Contents

Chapter 1: Hardware Configuration	1
1.1 Introduction	2
1.2 Specifications	3
1.2.1 Standard SBC functions	3
1.2.2 PCI-to-PCI Bridge	4
1.2.3 VGA interface	4
1.2.4 100Base-T Ethernet Interface	4
1.2.5 Mechanical and environmental specifications	5
1.3 Board Layout: Dimensions	6
1.4 Jumpers and Connectors	7
1.5 Board Layout: Jumper Locations	8
1.6 Board Layout: Connector Locations	10
1.7 Safety Precautions	11
1.8 Jumper Settings	12
1.9 Installing SDRAM (DIMMs)	15
Chapter 2: Connecting Peripherals	17
2.1 IDE Device connector (CN10) and Floppy Drive connector (CN9)	19
2.2 VGA Display Connector (CN2)	21
2.3 Parallel Port Connector (CN6)	21
2.4 Keyboard and PS/2 Mouse Connector (CN1)	21
2.5 Serial Ports (CN6: COM1 and COM2)	21
2.5.1 RS-232 connection (COM1-CN6)	22
2.5.2 RS-232/422/485 connection (COM2-CN6)	22
2.6 Power Connectors (CN7 & CN8)	22
2.6.1 Main power connector +5 V, +12 V (CN7)	22
2.6.2 CPU fan power supply connector (CN8)	23
2.7 Ethernet Configuration (CN4)	23
RJ-45A connector (CN4)	23
Network boot	23
2.8 USB Connector (CN5)	23

2.9 IR Interface (LED1)	24
2.10 Card Installation	24
Chapter 3: VGA Display & Ethernet Software Configuration ...	27
3.1 Introduction	28
3.2 Utility and Drivers	28
3.3 VGA Display Setup and Configuration	30
3.3.1 VGA Display Setup and Configuration for DOS	30
3.3.2 VGA Driver Setup for Autodesk ADI 4.2 (Protected Mode)	32
3.3.3 VGA Display Setup and Configuration for Microsoft Windows NT 3.5x	32
3.3.4 VGA Display Setup and Configuration for Microsoft Windows NT 4.0	34
3.3.5 VGA Display Setup and Configuration for Microsoft Windows 95	35
3.3.6 VGA Display Setup and Configuration for Microsoft Windows 3.x	36
3.3.7 VGA Display Setup and Configuration for IBM OS/2 Ver. 2.1	39
3.3.8 VGA Display Setup and Configuration for IBM OS/2 Warp 3.0 (Double Byte Character)	39
3.3.9 VGA Display Setup and Configuration for IBM OS/2 Warp 3.0 (Single Byte Character)	40
3.4 Ethernet Software Configuration	41
Chapter 4: Award BIOS Setup	43
4.1 AWARD BIOS Setup	44
4.1.1 Entering setup	44
4.1.2 Standard CMOS setup	45
4.1.3 BIOS features setup	46
4.1.4 CHIPSET features setup	50
4.1.5 Power management setup	51
4.1.6 PCI configuration setup	52
4.1.7 Load BIOS defaults	52

4.1.8	Load setup defaults	52
4.1.9	Integrated Peripherals	53
4.1.10	Password setting	53
4.1.11	IDE HDD auto detection	53
4.1.12	Save & exit setup	54
4.1.13	Exit without saving	54
Appendix A: Programming the Watchdog Timer		55
A.1	Programming the Watchdog Timer	56
Appendix B: Pin Assignments		59
B.1	CRT Display Connector (CN2)	60
B.2	COM1 RS-232 Serial Port (CN6)	60
B.3	COM2 RS-232/422/485 Serial Port (CN6)	61
B.4	Keyboard and Mouse Connector (CN1)	61
B.5	Main Power Connector (CN7)	62
B.6	IDE Hard Drive Connector (CN10)	63
B.7	USB Connector (CN5)	64
B.8	CPU Fan Power Connector (CN8)	64
B.9	Ethernet RJ-45 Connector (CN4)	65
B.10	Floppy Drive Connector (CN9)	66
B.11	Parallel Port Connector (CN6)	67
B.12	System I/O Ports	68
B.13	DMA Channel Assignments	69
B.14	Interrupt Assignments	70
B.15	1st MB Memory Map	70
B.16	J3 Connector Pin Assignments	71

Figures

Figure 1-1:	MIC-3355 board layout: Dimensions	6
Figure 1-2:	MIC-3355 board layout: Jumper locations	8
Figure 1-3:	MIC-3355 board layout: Connector locations	10
Figure 1-4:	MIC-3355 board layout: Jumper settings	13
Figure 2-1:	Installing the HDD	20
Figure 2-2:	Installing the card into the chassis	25
Figure 4-1:	Setup program initial screen	44
Figure 4-2:	CMOS setup screen	45
Figure 4-3:	BIOS features setup screen	46
Figure 4-4:	CHIPSET features setup screen	50
Figure 4-5:	Power management setup screen	51
Figure 4-6:	PCI configuration screen	52
Figure 4-7:	Integrated peripherals	53

Tables

Table 1-1:	MIC-3355 jumpers	7
Table 1-2:	MIC-3355 connectors	8
Table 1-3:	CPU clock ratio setting	14
Table 2-1:	List of connectors	18
Table 2-3:	MIC-3355 serial port default settings	22
Table B-1:	MIC-3355 CRT display connector	60
Table B-2:	MIC-3355 COM1 RS-232 serial port	60
Table B-3:	MIC-3355 COM2 RS-232/422/485 series port	61
Table B-4:	MIC-3355 keyboard connector	61
Table B-5:	MIC-3355 mouse connector	62
Table B-6:	MIC-3355 main power connector	62
Table B-7:	MIC-3355 IDE hard drive connector	63
Table B-8:	USB1/USB2 connector	64
Table B-9:	MIC-3355 CPU fan power connector	64
Table B-10:	MIC-3355 Ethernet RJ-45 connector	65
Table B-11:	MIC-3355 floppy drive connector	66
Table B-12:	MIC-3355 parallel port connector	67
Table B-13:	System I/O ports	68
Table B-14:	DMA channel assignments	69
Table B-15:	Interrupt assignments	70
Table B-16:	1st MB memory map	70
Table B-17:	J3 Connector Pin Assignments	71

Hardware Configuration

This chapter gives background information on the MIC-3355. It then shows you how to configure the card to match your application and prepare it for installation into your chassis.

Sections include:

- Card specifications
- Board layout: dimensions
- Board layout: jumper locations
- Board layout: connector locations
- Safety precautions
- Jumper settings
- Installing SDRAM (DIMMs)

1.1 Introduction

The MIC-3355 is a 6U-sized CompactPCI™, all-in-one single board Pentium® processor-based CPU card which complies with PICMG 2.0 R2.1 CompactPCI specifications. The MIC-3355 offers all the functions of an industrial computer on a single board CPU card. This card supports an Intel Pentium, Pentium MMX, AMD K5, AMD K6, Cyrix M1 or Cyrix M2 processor. The card accepts up to 256 MB SDRAM. It also supports on-board 512 KB PB-SRAM 2nd level cache.

The MIC-3355 uses a single-chip solution, allowing on-board DRAM to be shared with the built-in VGA controller. In this configuration, the chipset always acts as the arbiter between memory bus masters. This system ensures efficient memory allocation while substantially reducing the overall system cost.

On-board features include 512 KB 2nd level cache memory, 100/10 Mbps fast Ethernet interface, one RS-232 port, one RS-232/422/485 port, one multi-mode parallel (ECP/EPP/SPP) port, a floppy drive controller and a keyboard and PS/2 mouse interface. The built-in high speed PCI IDE controller supports both PIO and bus master modes. Two IDE channels are available through the J3 connector and one channel is available through the on-board connector. Up to two IDE devices can be connected to one channel, including large hard disks, CD-ROM drives, tape backup drives and other IDE devices. The MIC-3355 also supports two USB ports and one fast infrared port.

The MIC-3355 also features power management to minimize power consumption. It complies with the "Green Function" standard and supports three types of power saving features: Doze mode, Standby mode and Suspend mode. A watchdog timer can automatically reset the system or generate an interrupt should the system stop due to a program bug or EMI.

1.2 Specifications

1.2.1 Standard SBC functions

- **CPU:** Intel Pentium®, Pentium MMX, AMD K5, AMD K6, Cyrix M1, Cyrix M2, or IDT Win Chip C6
- **BIOS:** Award 256 KB (2 Mbit) memory; supports plug and play
- **Chipset:** SiS5598
- **L2 cache:** On-board 512 KB synchronous (pipeline burst) SRAM
- **Green function:** Features power management option via BIOS, activated by keyboard or mouse activity. Supports doze, standby and suspend modes. APM 1.1 compliant
- **RAM:** Two 168-pin DIMM sockets. Supports SDRAM with memory capacity up to 256 MB
- **EIDE interface:** Handles up to 4 IDE HDDs or other IDE devices via the J3 connector, or 2 IDE devices through the on-board connector. Supports PIO mode 4 and Ultra DMA mode
- **FDD interface:** Supports up to two floppy disk drives through the J3 connector or on-board connector
- **Parallel port:** Configured to LPT1, LPT2, LPT3 or disabled. Supports multi-mode parallel port (SPP/ECP/EPP)
- **Serial ports:** Two 16C550 UARTs, one RS-232, one RS-232/422/485 interface
- **Watchdog timer:** Can generate a system reset or IRQ 15. Software enabled/disabled. Time interval is from 1 to 63 seconds, jumperless with run-time setup
- **Keyboard/mouse connector:** 6-pin mini-DIN connector on the front panel
- **USB interface:** Two USB connectors with fuse protection. Complies with USB specification 1.0
- **Infrared port:** Fast IrDA. Transfer rate up to 4 Mbps. I/O port programmable to COM1 (3F8), COM2 (2F8), COM3 (3E8) or COM4 (2E8).

1.2.2 PCI-to-PCI Bridge

- **Controller chip:** Texas Instruments PCI2031
- Support up to six secondary bus masters. (Bus master cards can be installed in any slots except logic slot 8. Logic slot 8 accepts only slave card.)

1.2.3 VGA interface

- **Chipset:** SiS5598 built-in VGA function
- **Architecture:** Universal memory architecture
- **Display memory:** Share system RAM 0.5 MB ~ 4 MB through BIOS setting (refer to section 4.1.4 for detail)
- **Display Resolution:**
 - 640 x 480 with 256/32K/64K/16M color display, NI
 - 800 x 600 with 16/256/32K/64K/16M color display, NI
 - 1024 x 768 with 16/256/32K/64K/16M color display, NI
 - 1280 x 1024 with 16/256 color display, NI
 - 1280 x 1024 with 32K/64K color display, interlaced only
 - 1600 x 1200 with 256 color display, NI

1.2.4 100Base-T Ethernet Interface

- **Chipset:** REALTEK RTL8139A. PCI bus 100/10 Mbps Ethernet controller
- **Built-in boot ROM**

1.2.5 Mechanical and environmental specifications

- **Board size:** 233.35 x 160 mm (6u size)
- **Max. power requirements:** +5 V (4.75 ~ 5.25 V) @ 5.5 A
- **Operating temperature:** 0 ~ 60° C (32 ~ 140° F)
- **Storage temperature:** -20° C ~ 70° C (-4° ~ 158° F)
- **Humidity (operating and storage):** 5 ~ 95% (non-condensing)
- **Board weight:** 0.65 kg (1.4 lb)
- **Operating altitude:** 0 to 10,000 feet (3048 meters)
- **Storage/transit altitude:** 0 to 40,000 feet (12,190 meters)
- **Shock:** 20 G (operating); 50 G (storage/transit)
- **Vibration:** 1.5 G at 5-39 Hz, 100 - 200 Hz; 0.5 G 40 - 99 Hz (Y-axis)
1.5 G at 5-39 Hz, 0.5 G 40 - 200 Hz (X-axis)
1.5 G at 5-49 Hz, 0.75 G 50 - 200 Hz (Z-axis)

1.3 Board Layout: Dimensions

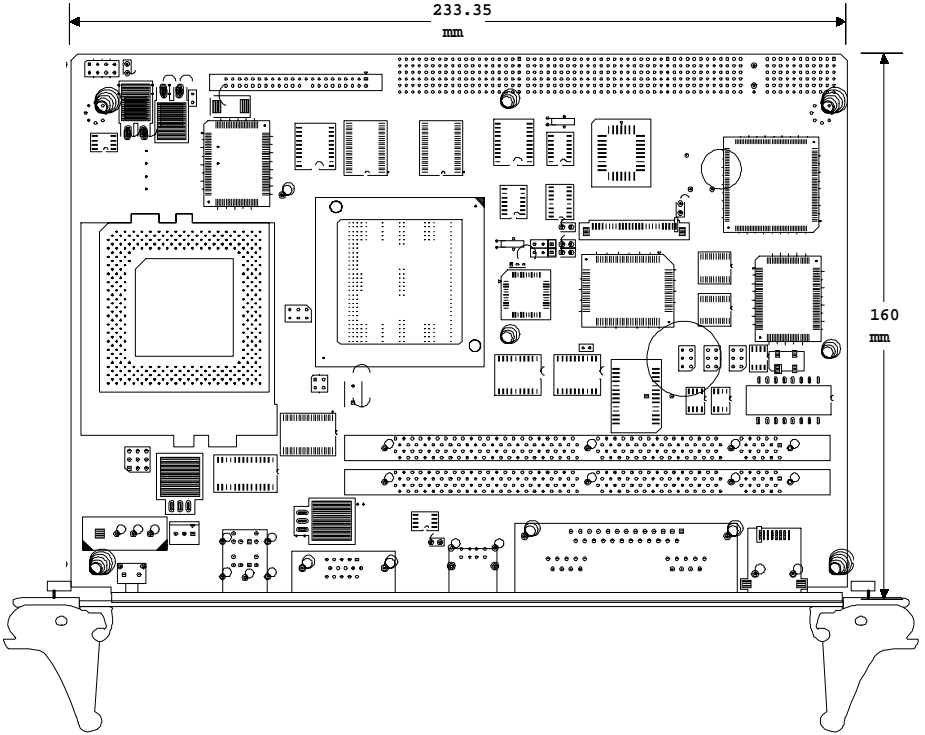

Figure 1-1: MIC-3355 board layout: Dimensions

1.4 Jumpers and Connectors

On-board connectors link it to external devices such as hard disk drives, a keyboard, or floppy drives. In addition, the board has jumpers for configuring your board for specific applications.

The table below lists the function of each of the board's jumpers and connectors. Later sections in this chapter give instructions on setting jumpers and detailed information on each jumper setting. Chapter 2 gives instructions for connecting external devices to your card.

Table 1-1: MIC-3355 jumpers

Number	Function
JP1	CPU dual/single power setting
JP2	CPU clock setting
JP3	COM2 RS-232/422/485 selection
JP4	COM2 RS-232/422/485 setting
JP5	COM2 RS-232/422/485 setting
JP6	CPU clock ratio setting
JP7	Watchdog timer control setting
JP9	Cyrix linear mode setting
JP10	CPU core voltage setting
JP11	clear CMOS

Table 1-2: MIC-3355 connectors

Number	Function
---------------	-----------------

CN1	Keyboard and PS/2 mouse
-----	-------------------------

CN2	VGA connector
-----	---------------

CN3	Reset switch
-----	--------------

CN4	10/100 Mbps LAN connector
-----	---------------------------

CN5	USB connector
-----	---------------

CN6	COM1, COM2, parallel port
-----	---------------------------

CN7	Main power connector
-----	----------------------

CN8	CPU fan power connector
-----	-------------------------

CN9	Floppy disk connector
-----	-----------------------

CN10	IDE connector
------	---------------

LED1	IR
------	----

LED2	Power, HDD activity LED
------	-------------------------

LED3	LAN LED
------	---------

Please refer to Appendix B for pin assignments.

1.5 Board Layout: Jumper Locations

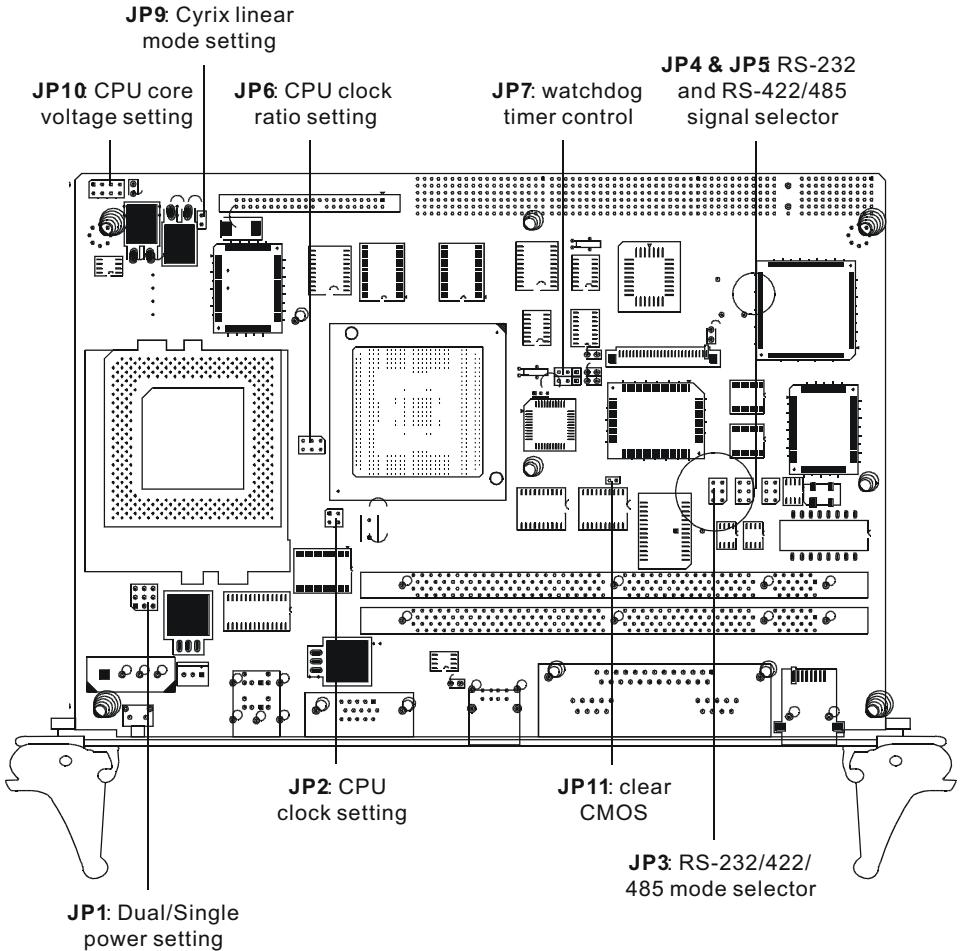

Figure 1-2: MIC-3355 board layout: Jumper locations

1.6 Board Layout: Connector Locations

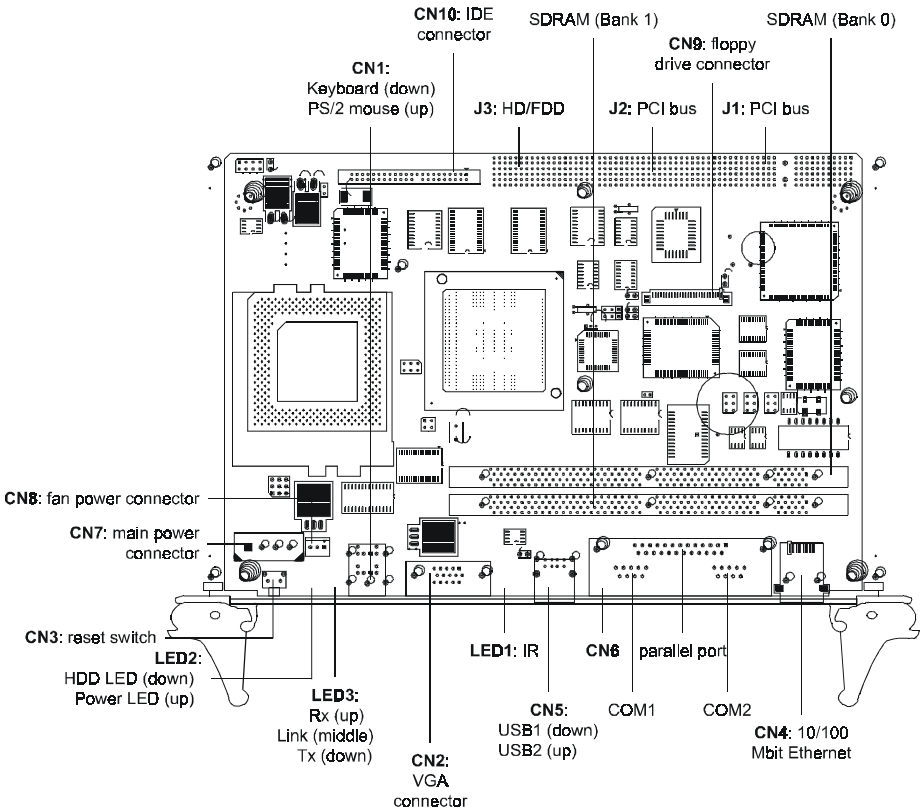

Figure 1-3: MIC-3355 board layout: Connector locations

1.7 Safety Precautions

Follow these simple precautions to protect yourself from harm and your PC from damage.

1. To avoid electric shock, always disconnect the power from your PC chassis before you work on it. Don't touch any components on the CPU card or other cards while the PC is on.
2. Disconnect power before making any configuration changes. The sudden rush of power as you connect a jumper or install a card may damage sensitive electronic components.
3. Always ground yourself to remove any static charge before you touch your CPU card. Be particularly careful not to touch the chip connectors. Modern integrated electronic devices, especially CPUs and memory chips, are extremely sensitive to static electric discharges and fields. Keep the card in its antistatic packaging when it is not installed in the PC, and place it on a static dissipative mat when you are working with it. Wear a grounding wrist strap for continuous protection.

1.8 Jumper Settings

This section tells how to set the jumpers to configure your card. It gives the card default configuration and your options for each jumper. After you set the jumpers and install the card, you will also need to run the BIOS Setup program (discussed in Chapter 4) to configure the serial port addresses, floppy/hard disk drive types and system operating parameters. Connections, such as hard disk cables, appear in Chapter 2.

For the locations of each jumper, see the board layout diagram depicted earlier in this chapter.

You configure your card to match the needs of your application by setting jumpers. A jumper is the simplest kind of electric switch. It consists of two metal pins and a small metal cap (often protected by a plastic cover) that slides over the pins to connect them. To "close" a jumper you connect the pins with the cap. To "open" a jumper you remove the cap. Sometimes a jumper will have three pins, labeled 1, 2 and 3. In this case you connect either pins 1 and 2 or 2 and 3.

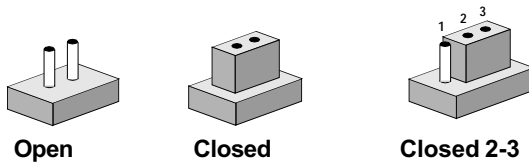

You may find a pair of needle-nose pliers useful for setting the jumpers.

If you have any doubts about the best hardware configuration for your application, contact your local distributor or sales representative before you make any changes.

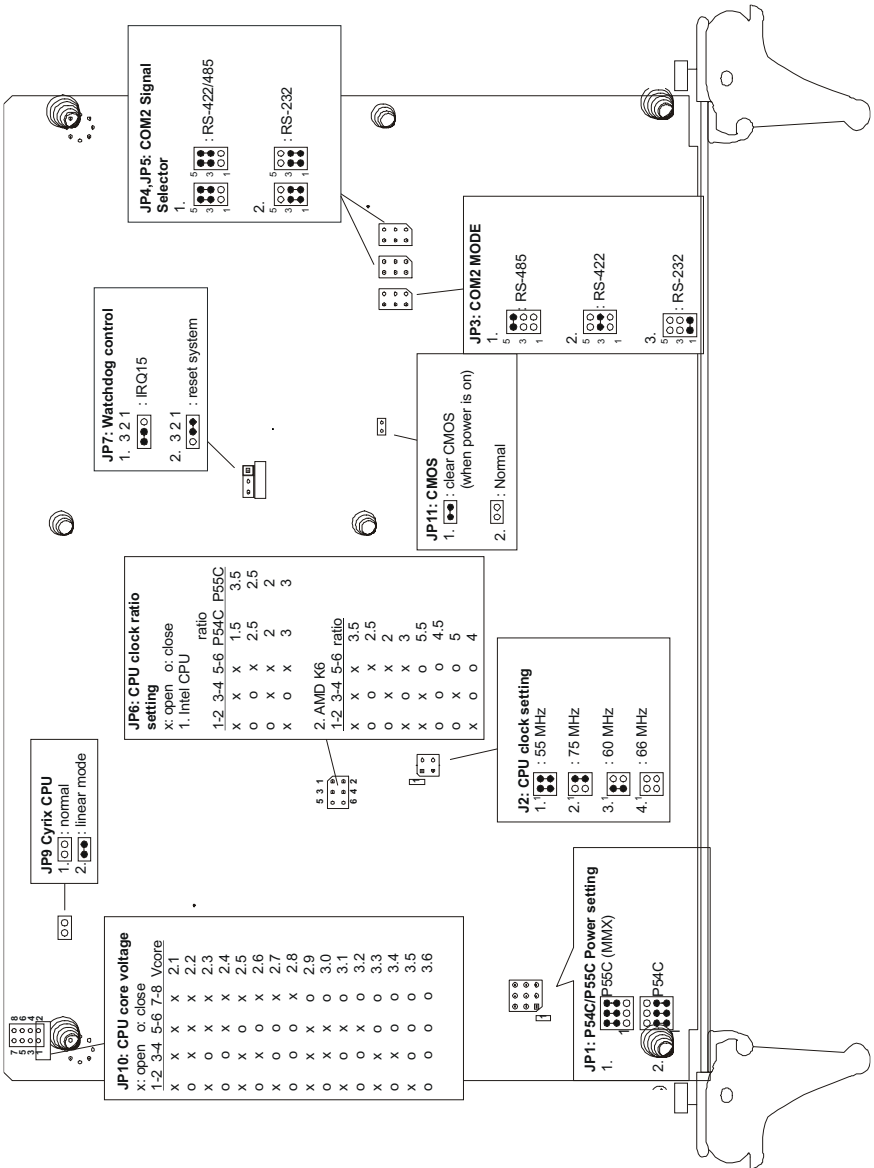

Figure 1-4: MIC-3355 board layout: Jumper settings

CPU Clock Ratio Setting

Table 1-3: CPU clock ratio setting

CPU mode	CPU clock	Bus clock	Clock Ratio	JP6			JP2	
				1-2	3-4	5-6	1-2	3-4
Pentium 233MHz	233	66	3.5	x	x	x	x	x
Pentium 200MHz	200	66	3.0	x	o	x	x	x
Pentium 166MHz	166	66	2.5	o	o	x	x	x
Pentium 150MHz	150	60	2.5	o	o	x	o	x
Pentium 133MHz	133	66	2.0	o	x	x	x	x
Pentium 120MHz	120	60	2.0	o	x	x	o	x
Pentium 100MHz	100	66	1.5	x	x	x	x	x
Pentium 90MHz	90	60	1.5	x	x	x	o	x
Pentium 75MHz	75	50	1.5	x	x	x	o	o
AMD K6-300	300	66	4.5	o	o	o	x	x
AMD K6-266	266	66	4.0	o	x	o	x	x
AMD K6-233	233	66	3.5	x	x	x	x	x
AMD K6-200	200	66	3.0	x	o	x	x	x
AMD K6-166	166	66	2.5	o	o	x	x	x
Cyrix 6x86MX-PR166GP	133	66	2.0	o	x	x	x	x
Cyrix 6x86MX-PR166GP	150	60	2.5	o	o	x	o	x
Cyrix 6x86MX-PR200GP	166	66	2.5	o	o	x	x	x
*Cyrix 6x86MX-PR200GP	150	75	2.0	o	x	x	x	o
*Cyrix 6x86MX-PR233GP	187.5	75	2.5	o	o	x	x	o
*Cyrix MII-300GP	225	75	3.0	x	o	x	x	o
Cyrix MII-300GP	233	66	3.5	x	x	x	x	x
IDT WinChip C6-180	180	60	3.0	x	o	x	o	x
IDT WinChip C6-200	200	66	3.0	x	o	x	x	x
*IDT WinChip C6-225	225	75	3.0	x	o	x	x	o
IDT WinChip C6-240	240	60	4.0	o	x	o	o	x

x: open

o: closed

*: Bus clock of 75 MHz is not recommended to use.

JP9 Cyrix CPU

This jumper is for Cyrix CPUs only. Close it only when using Cyrix brand CPUs.

JP11 Clear CMOS

This jumper is used to erase CMOS data and reset system BIOS information.

The procedure for clearing CMOS appears below.

1. Turn off the system.
2. Short JP11
3. Turn on the system. The CMOS is now cleared.
4. Turn off the system. Open JP11.
5. Turn on the system. The BIOS is reset to its default setting.

1.9 Installing SDRAM (DIMMs)

The MIC-3355 provides two 168-pin DIMM sockets. Each socket accepts 16, 32, 64 or 128 MB SDRAM with access time ≤ 60 ns. The MIC-3355 supports a single SDRAM which has to be installed in Bank 0 for on-board VGA.

NOTE: *The modules can only fit into a socket one way. Their gold pins must point down into the DIMM socket.*

The procedure for installing DIMMs appears below. Please follow these steps carefully.

1. Ensure that all power supplies to the system are switched Off.
2. Install the DIMM module. Install the DIMM so that its gold pins point down into the DIMM socket.
3. Slip the DIMM into the socket and carefully fit the bottom of the card against the connectors.

4. Gently push the DIMM into a perpendicular position until the clips on the ends of the DIMM sockets snap into place.
5. Check to ensure that the DIMM is correctly seated and all connector contacts touch. The DIMM should not move around in its socket.

CHAPTER 2

Connecting Peripherals

This chapter tells how to connect peripherals to the MIC-3355. You can access most of the connectors from the front panel.

The following table lists the connectors on the MIC-3355.

Table 2-1: List of connectors

Number	Function
J1	Compact PCI bus (32-bit)
J2	Compact PCI bus (64-bit)
J3	IDE and FDD interface
CN1	Keyboard and PS/2 mouse
CN2	VGA connector
CN3	Reset switch
CN4	100/10 Mbps LAN connector
CN5	USB connector
CN6	COM1, COM2, parallel port
CN7	Main power connector
CN8	CPU fan connector
CN9	Floppy disk connector
CN10	IDE connector (primary)
LED1	Infrared interface
LED2	Power, HDD activity LED
LED3	LAN LED

The following sections tell how to make each connection. In most cases, you will simply need to connect a standard cable. All of the connector pin assignments are shown in Appendix B.

Warning! *Always completely disconnect the power cord from your chassis whenever you are working on it. Do not make connections while the power is on. Sensitive electronic components can be damaged by a sudden rush of power.*



Caution! *Always ground yourself to remove any static charge before touching the CPU card. Modern electronic devices are very sensitive to static electric charges. Use a grounding wrist strap at all times. Place all electronic components on a static-dissipative surface or in a static-shielded bag when they are not in the chassis.*



2.1 IDE Device connector (CN10) and Floppy Drive connector (CN9)

The MIC-3355 provides two IDE (Integrated Device Electronics) channels and one floppy drive interface through the CompactPCI J3 connector. These connect to two IDE and one floppy drive connectors on Advantech's 6U-sized backplane. The primary IDE channel is also available through the on-board 44-pin connector (CN10), which accepts a 2.5" hard drive by using the hard drive bracket, or an IDE flash disk module (i.e., Advantech's PCD-1230).

Users can attach two IDE devices to each IDE channel, either to the backplane or to the on-board connector. If two drives are installed in one channel, remember to set one as the master and the other one as the slave. You may do this by setting the jumpers on the drives. Refer to the documentation that came with your drive for more information. A jumper diagram usually appears on the top side of a hard disk drive.

Users can attach up to two floppy disk drives to the floppy connector on the backplane. The MIC-3355 supports any combination of 5.25" (360 KB/1.2 MB) and/or 3.5" (720 KB/1.44/2.88 MB) drives. The on-board connector (CN9) can also be used to connect to a 3.5" floppy drive by using a 26-pin FPC cable. However, due to the limited space, there is no access to the floppy drive on the front panel. We do not recommend the use of this connector.

Warning: Plug the other end of the cable into the drive with pin 1 on the cable corresponding to pin 1 on the drive. Improper connection will damage the drive.



Note: We don't recommend connection to following IDE HDD models of Seagate: ST 31276A, ST 31720A, ST 32531A, ST 33240A or ST 34340A

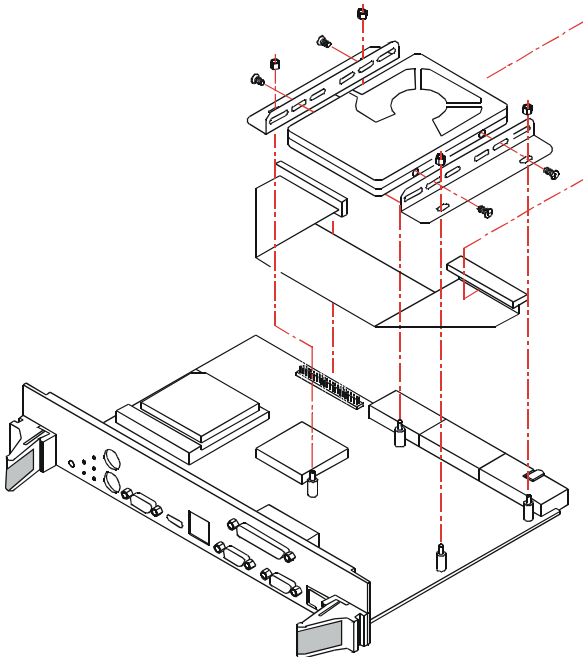

Figure 2-1: Installing the HDD

2.2 VGA Display Connector (CN2)

The MIC-3355 provides a VGA controller for a high resolution VGA interface. The MIC-3355's CN2 is a DB-15 connector for VGA monitor input. Pin assignments for the CRT display are detailed in Appendix B. Share memory architecture supports 0.5 MB, 1 MB, 1.5 MB, 2 MB, 2.5 MB, 3 MB, 3.5 MB and 4 MB system memory. The memory is configured in the system BIOS setup.

2.3 Parallel Port Connector (CN6)

The parallel port is normally used to connect the CPU card to a printer. The MIC-3355 includes an on-board parallel port, accessed through a DB 25-pin connector, CN6 on the front panel.

The parallel port is designated as LPT1 and can be disabled or changed to LPT2 or LPT3 in the system BIOS setup.

2.4 Keyboard and PS/2 Mouse Connector (CN1)

The MIC-3355 provides two connectors for connection of keyboard and PS/2 mouse on the front panel. Since these two connectors are identical, please be careful to plug in keyboard or mouse into the correct connector.

2.5 Serial Ports (CN6: COM1 and COM2)

The MIC-3355 offers two serial ports: COM1 in RS-232, COM2 in RS-232/422/485. These ports let you connect to serial devices (a mouse, printers, etc.) or a communication network.

You can select the address for each port (For example, 3F8H [COM1], 2F8H [COM2]) or disable it, using the BIOS Advanced Setup program, covered in Chapter 4.

2.5.1 RS-232 connection (COM1-CN6)

Different devices implement the RS-232 standard in different ways. If you are having problems with a serial device, be sure to check the pin assignments for the connector.

2.5.2 RS-232/422/485 connection (COM2-CN6)

COM2 is an RS-232/422/485 serial port. The specific port type is determined by jumper settings, as detailed in Chapter 1.

The IRQ and address range for both ports are fixed. However, if you wish to disable the port or change these parameters later, you can do this in the system BIOS setup. The table below shows the settings for the MIC-3355 board's ports:

Table 2-3: MIC-3355 serial port default settings

Port	Address	Default
COM1	3F8, 2F8, 3E8, 2E8	3F8/IRQ4
COM2	3F8, 2F8, 3E8, 2E8	2F8/IRQ3

2.6 Power Connectors (CN7 & CN8)

2.6.1 Main power connector +5 V, +12 V (CN7)

The on-board power connector allows users to operate MIC-3355 with external power supply without plugging into a chassis. The CN7 provides power input connection to +5 V and +12V.

2.6.2 CPU fan power supply connector (CN8)

This connector provides power supply to the optional CPU cooling fan. This connector is only available when +5 V and +12 V power is supplied to the board.

Warning! *Before making the connection, make sure the voltage is absolutely correct and matched with the correct connector.*

2.7 Ethernet Configuration (CN4)

The MIC-3355 is equipped with a high performance 32-bit PCI-bus Fast Ethernet interface which is fully compliant with IEEE 802.3u 100/10Base-T specifications. It is supported by all major network operating systems and is 100% Novell NE-2000 compatible.

The medium type can be configured via the RSET8139.EXE program included on the utility CD-ROM disc. (See Chapter 3 for detailed information.)

RJ-45A connector (CN4)

100/10BASE-T connects to the MIC-3355 via an adapter cable to the RJ-45 standard jack.

Network boot

The Network Boot feature is built into the BIOS. It can be enabled/disabled in the chipset setup of the CMOS configuration. Refer to "BIOS Setting" in Chapter 4 for more information.

2.8 USB Connector (CN5)

The MIC-3355 board provides two USB (Universal Serial Bus) interfaces, which give complete plug and play, hot attach/detach for up to 127 external devices. The USB interfaces comply with USB specification rev. 1.0 and are fuse protected.

The USB interfaces can be disabled in the system BIOS setup.

2.9 IR Interface (LED1)

The IR interface supports the wireless infrared transmitting and receiving module. You must configure the setting through BIOS setup.

2.10 Card Installation

The CompactPCI connectors are firm and rigid, and require careful handling while plugging and unplugging. Improper installation of a card can easily damage the backplane of the chassis.

The insert/eject handles of MIC-3355 help you to install and remove the card easily and safely. Follow the procedure below to install the MIC-3355 into a chassis:

To install a card:

1. Hold the MIC-3355 vertically. Be sure that the card is pointing in the correct direction. The components of the card should be pointing to the right-hand side.
2. Holding both handles, pull out the red portion in the middle of the handle to unlock it.

Caution: Keep your fingers away from the hinge to prevent your fingers from getting pinched.

3. Insert the card into the chassis by sliding the upper and lower edges of the card into the card guide.
4. Push the card into the slot gently by sliding the card along the card guide until the handles meet the rectangular holes of the cross rails.

Note: If the card is correctly positioned and has been slid all the way into the chassis, the handles should match the rectangular holes. If not, remove the card from the card guide and repeat step 3 again. Do not try to install a card by forcing it into the chassis.

5. Pull the upper handle down and lift the lower handle up to push the card into place.

6. Secure the card by pushing in the red handle to lock it into place.

To remove a card:

1. Unscrew the four screws on the front panel. Pull out the red part to unlock the handles.
2. Lift the upper handle up and press the lower handle down to release the card from the backplane.
3. Slide the card out.

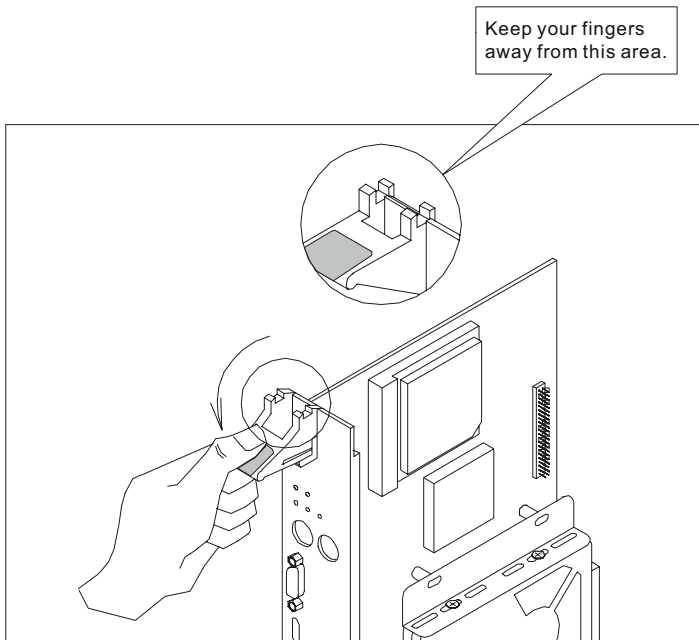

Figure 2-2: Installing the card into the chassis

VGA Display & Ethernet Software Configuration

This chapter details the software configuration information. It shows you how to configure the board to match your application requirements. The AWARD System BIOS is covered in Chapter 4.

Sections include:

- VGA display configuration
- Ethernet interface configuration

3.1 Introduction

The MIC-3355 uses the SiS5598 chipset. This chipset includes a high-performance VGA display controller, which uses system SDRAM as display memory. The shared memory size can easily be adjusted from 0.5 MB to 4 MB by setting BIOS, which is covered in Chapter 4. The larger memory size allows high display resolution and more display color.

3.2 Utility and Drivers

The MIC-3355 is supplied with a software utility CD-ROM that holds the necessary files for setting up the VGA display and Ethernet under the directory `\MIC3000\SiS5598` and `\MIC3000\RTL8139A`.

The following lists the contents and pathnames of this CD-ROM:

- **MIC3000\SiS5598\README.TXT**: ASCII text file.
- **MIC3000\SiS5598\RELEASE.TXT**: Text file of driver release note
- **MIC3000\SiS5598\IDE <DIR>**: SiS IDE drivers and Readme files for SiS chipset 5513, 5571, 5581, 5582, 5597, 5598, 559 and 5592
- **MIC3000\SiS5598\MM <DIR>**: SISTAG (disk tag file for Windows NT 3.5x)
- **MIC3000\SiS5598\MM <DIR>**: RELEASE.TXT (Text file of driver release note)
- **MIC3000\SiS5598\MM\BIOS <DIR>**: contains SiS SVGA BIOS binary file. It is not a driver file but for your reference only.
- **MIC3000\SiS5598\MM\DOS <DIR>**: Including the following files and sub-directories:
 - **INSTDRV.EXE**: Unpack & copy program of ADI 4.2

- **SVGAUTIL.EXE**: SiS5598 SVGA Utility Program
- **MIC3000\SiS5598\MM\DOS\ADI42 <DIR>**: Contains AutoCAD, AutoShade, 3D Studio driver files
- **MIC3000\SiS5598\MM\DOS\ET <DIR>**: Contains ETen Chinese system display driver (ETDSPDRV.COM) v. 119B01 to support SiS SVGA. You may update this driver to your ETen Chinese system if you have the old version or you may ignore it if you have the newer version.
- **MIC3000\SiS5598\MM\OS2 <DIR>**: Contains IBM OS/2 Ver. 2.1, IBM OS/2 Warp 3.0 (double-byte) and IBM OS/2 Warp 3.0 (single byte) driver files. Including the following sub-directories:
 - **MIC3000\SiS5598\OS2\SBCS.21 <DIR>**: SISINST.CMD: SiS 5597/5598 VGA OS/2 2.1 setup program
 - **MIC3000\SiS5598\OS2\DBCS.30 <DIR>**: SETUP.CMD: SiS 5597/5598 SVGA OS/2 3.0 setup program, contains IBM OS/2 WARP 3.0 (double-byte: Chinese, Japanese, Korean, etc.) driver files.
 - **MIC3000\SiS5598\OS2\SBCS.30 <DIR>**: SISINST.CMD: SiS 5597/5598 VGA OS/2 3.0 Setup Program, contains IBM OS/2 WARP 3.0 (single-byte) driver files.
- **MIC3000\SiS5598\MM\WIN31 <DIR>**: Contains Windows 3.X driver, setup program, SiS MMPlayer and utilities.
- **MIC3000\SiS5598\MM\WIN95 <DIR>**: Contains Windows 95 driver, setup program, SiS MMPlayer, Direct Draw driver and utilities.

- **MIC3000\SiS5598\MM\WINNT <DIR>**: Contains Windows 3.5x, 4.0 driver files and contains the following sub-directories:
 - **MIC3000\SiS5598\WINNT\WINNT35 <DIR>**: Contains Windows NT 3.5x driver files OEMSETUP.INF: SiS SVGA setup information file (NT 3.5x)
 - **MIC3000\SiS5598\WINNT\WINNT40 <DIR>**: Contains Windows NT 4.0 driver files SISV5597.INF: SiS SVGA setup information file (NT 4.0)

3.3 VGA Display Setup and Configuration

3.3.1 VGA Display Setup and Configuration for DOS

3.3.1.1. General Description

SVGAUTL.EXE is one of the utilities for VGA controller SiS5598. It supports three functions:

1. Video mode setting
2. Frame rate setting
3. Power saving setting

Since SiS5598 supports many enhanced text mode and graphic modes, you can use SVGAUTL.EXE to select the desired video mode.

For 640 x 480, 800 x 600, 1024 x 768 and 1280 x 1024 resolutions, SiS5598 SVGA supports multiple frame rates.

If your monitor could synchronize with these frame rates, you can use SVGAUTL.EXE to take advantage of your monitor's features.

SiS 5597/5598 also supports VESA DPMS power saving modes. SVGAUTL.EXE can help you make the settings.

3.3.1.2. How to Use SVGAUTL.EXE,

1. Type "SVGAUTL" in the directory where it resides. For example:

```
D:\MIC3000\SiS5598\DOS\SVGAUTL <Enter>
```

(assume the CD-ROM drive letter is "D:\")

2. The Main Menu appears and directs you to configure SiS5598.
3. When you complete configuration, you may save your preferences to the AUTOEXEC.BAT file and use it as your power-on (or hardware reset) default environment.

3.3.1.3. Parameters Explanation

The meaning of parameters used by SVGAUTL.EXE are explained below:

Syntax:

```
>SVGAUTL [/D:mode_no] [/F0:n0] [/F1:n1]
[/F2:n2] [/F3:n3] [/PA:ta] [/PB:tb]
```

where

/D: Set the video mode to be mode_no (hex)

For example: Set 1024 x 768, 256-color graphic mode:

```
>SVGAUTL /D:38 <Enter>
```

/F0: For 640 x 480, set frame rate to be n0 Hz.

Three available frame rates are 60, 72 and 75 Hz.

For example: Set 640 x 480 graphic mode with 60 Hz frame rate

```
>SVGAUTL /F0:60 <Enter>
```

/F1: For 800 x 600, set frame rate to be n1 Hz.

Four available frame rates are 56, 60, 72 and 75 Hz.

For example: Set 800 x 600 graphic mode with 72 Hz frame rate:

```
>SVGAUTL /F1:72 <Enter>
```

/F2: For 1024 x 768, set frame rate to be n2 Hz.

Four available frame rates are 87 (interlaced), 60, 70, and 75 Hz.

For example: Set 1024 x 768 graphic mode with 60 Hz frame rate:

```
>SVGAUTL /F2:60 <Enter>
```

/F3: For 1280 x 1024, set frame rate to be n3 Hz.

Two available frame rates are 87 (interlaced) and 60 Hz.

For example: Set 1280 x 1024 graphic mode with 60 Hz frame rate:

>SVGAUTL /F3:60 <Enter>

/PA: Set standby timer to be t_a minutes. ($0 < t_a < 15$ min.)

For example: Set Standby Timer to be 5 minutes:

>SVGAUTL /PA:5 <Enter>

/PB: Set suspend timer to be t_b minutes. ($0 < t_b < 15$ min.)

For example: Set suspend timer to be 5 minutes:

>SVGAUTL /PB:5 <Enter>

Note:

1. Suspend time would be " $t_a + t_b$ ". (i.e. standby time + suspend time)
2. The timers will not be very accurate and approximate the time that you set

3.3.2 VGA Driver Setup for Autodesk ADI 4.2 (Protected Mode)

Concerning how to setup VGA for AutoCAD R11, AutoCAD R12, AutoShade R2.0 and 3D Studio Version 3.0., please refer to MIC3000\SiS5598\README.TXT on the accompanying CD-ROM disc.

3.3.3 VGA Display Setup and Configuration for Microsoft Windows NT 3.5x

3.3.3.1 Driver Installation:

- a. Select Control Panel from Main group.
- b. Select Display icon.
- c. Select Change Display Type from Display Settings.
- d. Select Change from Display Type.

- e. Select Other from Select Device.
- f. Place the CD-ROM into CD-ROM Drive.
- g. When the "Install from Disk" dialog box appears, type "D:\MIC3000\SiS5598\MM\WINNT\WINNT35" and click "OK".
- h. Select Install and click "Yes" when the "Installing Driver" dialog box appears.
- i. Select New when the "Windows NT Setup" dialog box appears. Click "Continue".

A message will appear stating that the drivers were successfully installed. Click "OK". You must now restart Windows NT 3.51.

3.3.3.2 Selecting resolution and color depth:

- a. Select Control Panel from the Main group.
- b. Select Display icon.
- c. Select Color Palette to change between 16 colors, 256 colors, 32768 colors, 65536 colors and 16777216 colors.
- d. To select desktop resolution size, go to the Desktop area and use the slide bar to change resolution from 640 x 480, 800 x 600, 1024 x 768, and 1280 x 1024.
- e. Select Test to test the resolution.
- f. If the display test screen was good then select "Yes" when the "Testing Mode" dialog box appears. If the display test screen was bad then select "No". Windows NT will give you an error message.
- g. If the display test screen was good and you select "Yes", Windows NT 3.5x will prompt you to restart Windows NT 3.5x.

3.3.4 VGA Display Setup and Configuration for Microsoft Windows NT 4.0

3.3.4.1 Driver Installation:

- a. Click the "Start" menu and select Control Panel from the Settings group.
- b. Select the Display icon.
- c. Select Settings of Display Properties.
- d. Select Display Type.
- e. Select Change from the Adapter Type area.
- f. Select Have Disk in the Change Display screen.
- g. Place the CD-ROM disc into the CD-ROM drive.
- h. When the "Install from Disk" dialog box appears, type "D:\MIC3000\SiS5598\MM\WINNT\WINNT40" and click "OK".
- i. When the "Change Display" dialog box appears, click "OK".
- j. When the "Third-party Drivers" dialog box appears, click "Yes".

A message will appear stating that the drivers were successfully installed. Click "OK". You must now restart Windows NT 4.0.

3.3.4.2 Selecting resolution and color depth

- a. Click the "Start" menu and select Control Panel from the Settings group.
- b. Select Display icon.
- c. Select Settings.
- d. Select Color Palette to change between 16 colors, 256 colors, 32768 colors, 65536 colors and 16777216 colors.
- e. To select desktop resolution size, go to the Desktop area and use the slide bar to change resolution from 640 x 480, 800 x 600, 1024 x 768 to 1280 x 1024.
- f. Select Test to test the resolution. If the display test screen was good then select "Yes" when the "Testing Mode" dialog box appears. If the display test screen was bad then select "No". Windows NT will give you an error message.
- g. Click "OK". If the display test screen was good and you select "Yes", Windows NT 4.0 will change the mode without restarting Windows NT 4.0.

3.3.5 VGA Display Setup and Configuration for Microsoft Windows 95

3.3.5.1 Driver Installation

- a. Click "Start" menu and select Control Panel from Settings group.
- b. Select "Display" icon.
- c. Select "Settings" index in the display properties sheet.
- d. Select "Change Display Type" button.
- e. Select "Change..." button in "Adapter Type" group.
- f. Select "Have Disk" button.
- g. Place the CD-ROM disc into CD-ROM drive.
- h. When the "Install from Disk" dialog box appears, type "D:\MIC3000\SiS5598\MM\WINNT\WIN95" and click "OK".
- i. When the "Change Display" dialog box appears, click "Close".
- j. Select the "Close" or "Apply" button from the display properties sheet.
- k. A message will appear stating that you must restart Windows 95. Select "yes" to restart.
- l. After restarting, Windows 95 will run on 640 x 480 at 256 colors, 75Hz NI.

3.3.5.2 Selecting resolution, color depth, and refresh rate

- a. Click "Start" menu and select Control Panel from Settings group.
- b. Select Display icon.
- c. Select Settings.
- d. Select Color Palette to change between 16-color, 256-color, Hi-color, and True-color.
- e. To select desktop resolution size, go to the Desktop area and use the slide bar to change resolution from 640 x 480, 800 x 600, 1024 x 768 and 1280 x 1024.
- f. Select Refresh rate list box to change the screen refresh rate.

- g. Click "OK" or "Apply".

3.3.5.2 Install the Utility for Windows 95

- a. Place the CD-ROM disc into the CD-ROM drive.
- b. Click "Start" menu and select "Run..." menu item.
- c. In "Run" dialog, type:
"D:\MIC3000\SiS5598\MM\WIN95\SETUP.EXE"
- d. The Setup procedure will create a "SiS Multimedia Vx.xx" program group, including 3 items:
 - Multimedia Manager
 - SiS MMPlayer
 - Center Screen
- e. A Setup Successful dialog will appear when setup completes. You are given the option of restarting your computer and finalizing the changes.

3.3.6 VGA Display Setup and Configuration for Microsoft Windows 3.x

3.3.6.1 Display Driver and Utility Installation

- a. Click "File" menu and select "Run..." menu item.
- b. In "Run" dialog, type:
D:\MIC3000\SiS5598\MM\WIN31\SETUP.EXE
- c. Follow the setup program's on-screen instructions.
- d. Setup procedure will create a "SiS Multimedia Vx.xx" program group, including 5 items:
 - Multimedia Manager
 - SiS MMPlayer
 - SVGA Setup
 - Center Screen
 - Uninstall

- e. A Setup Successful dialog will appear when setup completes. You are given the option of restarting your computer and finalizing the changes.

3.3.6.2. Graphics Setup

- a. In the "SiS Multimedia Vx.xx" program group, choose "SVGA Setup" icon to enter "SiS VGA Configuration System" screen.
- b. In "SiS VGA Configuration System" screen, choose which options you would like to use.
- c. After completing your selections, choose "OK" to make all your selections effective.
- d. Choose "Restart Windows" to re-boot Windows using the new settings. Or, choose "Continue" to finalize the changes later.

3.3.6.3. Power Saving Setup in Windows

- a. In the "SiS VGA Configuration System" screen, choose "power saver" item to enter "Power Saver" screen.
- b. In the "Power Saver" Screen, choose which options you would like to use.
- c. After completing the selections, choose "OK" to make all your selections effective.
- d. After completing setup, the power_saver should take effect after the time interval has elapsed.

3.3.6.4. Zoom_Key Setup

In the "SiS VGA Configuration System" screen, choose "zooming" item to define "hot keys" for enlarging or making the screen smaller without entering the setup program.

The operation principles of zoom-in and zoom-out are as follows:

- 1. The resolution change sequence for zoom-in is:
1024 x 768 ———→ 800 x 600 ———→ 640 x 480
- 2. The resolution change sequence for zoom-out is:
640 x 480 ———→ 800 x 600 ———→ 1024 x 768

Note: You cannot zoom-out to a resolution larger than you have previously configured.

To use this feature, follow this procedure:

- a. In the "SiS VGA Configuration System" screen, choose "zooming" item to enter the "Zooming Hotkey" screen.
- b. In the "Zooming Hotkey" Screen, choose which "hot-key" you would like to use and enable it.
- c. After completing the selections, choose "OK" to make all your selections effective.
- d. After completing the setup, you may use your own defined hot key to zoom-in or zoom-out.

Note: The power saver's timer settings would be effective even after exiting Windows back to DOS.

3.3.6.5 MPEG1 Video Operations

SiS 5597/5598 supports DCI drivers for software MPEG playback and other media player programs which can take advantage of DCI.

The SiS 5597/5598 DCI driver is automatically loaded during the "Windows Driver Unpack & Copy" process. Therefore it should be transparent to the end-user and any media players can take advantage of it.

To make software MPEG playback better than what your original software MPEG player supplier provided, SiS provide an MMPlayer application program to provide a VCP-like (Video Cassette Player) interface.

To take advantage of the SiS MMPlayer, you must first install "SW MPEG Player". SiS provides an interface but not a software MPEG player. If the software MPEG player (Xing or Mediamatics) does not exist, the SiS MMPlayer will not work.

To use the SiS MMPlayer, choose the "SiS MMPlayer" icon in the "SiS Multimedia Vx.xx" program group and the SiS MMPlayer VCP-like icon will appear. You can then enjoy the software MPEG playback.

3.3.7 VGA Display Setup and Configuration for IBM OS/2 Ver. 2.1

3.3.7.1 OS2 V2.1 Display Driver Installation

- a. Before installing SiS OS/2 V2.1 display driver, start up OS/2 system in standard VGA mode.
- b. Select "Command Prompt" folder.
- c. Select "OS/2 window" or "OS/2 full screen" icon.
- d. Place the CD-ROM disc into the CD-ROM drive.
- e. Change the directory to D:\MIC3000\SiS5598\MM\OS2\SBCS.21.
- f. Type SISINST then press "Enter".
- g. When the "Select Screen Parameters for SiS SVGA" dialog appears, select the resolution, color depth and frame rate you would like, then click "OK"
- h. The installation program will create a "SiS Setup" icon on the desktop.
- i. Shut down and re-boot OS/2 V2.1.

3.3.8 VGA Display Setup and Configuration for IBM OS/2 Warp 3.0 (Double Byte Character)

3.3.8.1 OS/2 Warp Display Driver Installation (For DBCS version)

- a. Before installing SiS OS/2 Warp display driver, start up OS/2 system in standard VGA mode.
- b. Select "Command Prompt" folder.
- c. Select "OS/2 window" or "OS/2 full screen" icon.
- d. Place the CD-ROM disc into the CD-ROM drive.
- e. Change the directory to D:\MIC3000\SiS5598\MM\OS2\DBCS.30.
- f. Type SETUP and then press "Enter".
- g. Setup procedure will create a "SiS Install" icon on the desktop.
- h. Shutdown and reboot the OS/2 Warp system.

- i. When the system reboots, double-click the "SiS Install" icon. It will perform the further installation.
- j. When the "Select Screen Parameters for SiS SVGA" dialog appears, select the resolution, color depth and frame rate you would like, then click "OK"
- k. The installation program will create a "SiS Setup" icon on the desktop.
- l. Shutdown and re-boot OS/2 Warp.

3.3.9 VGA Display Setup and Configuration for IBM OS/2 Warp 3.0 (Single Byte Character)

3.3.9.1 OS2 Warp Display Driver Installation (For SBCS version)

- a. Before installing the SiS OS/2 Warp display driver, start up OS/2 system in standard VGA mode.
- b. Select "Command Prompts" folder.
- c. Select "OS/2 window" or "OS/2 full screen" icon.
- d. Place the CD-ROM disc into the CD-ROM drive.
- e. Change directory to D:\MIC3000\SiS5598\MM\OS2\SBCS.30
- f. Type SISINST and then press "Enter".
- g. When the "Select Screen Parameters for SiS SVGA" dialog appears, select the resolution, color depth and frame rate you would like and then click "OK".
- h. The installation program will create a "SiS Setup" icon on the desktop.
- i. Shutdown and re-boot OS/2 Warp.

3.4 Ethernet Software Configuration

The MIC-3355's on-board Ethernet interface supports all major network operating systems. To configure the medium type, to view the current configuration, or to run diagnostics:

1. Power-on the MIC-3355. Ensure that the utility CD-ROM disc is located in the CD-ROM drive.
2. At the prompt, type `\MIC3000\RTL8139A\RSET8139.EXE` and press `<Enter>`. The Ethernet configuration program will then be displayed.
3. This simple screen shows all the available options for the Ethernet interface. Just highlight the option you want to change by using the Up and Down keys. To change a selected item, press `<Enter>` and a screen will appear with the available options. Highlight your option and press `<Enter>`. Each highlighted option has a helpful message guide displayed at the bottom of the screen for additional information.
4. After you have made your selections and are certain it is the configuration that you want, press ESC. A prompt will appear asking if you want to save the configuration. Press Y if you want to save.

The Ethernet Setup Menu also offers three very useful diagnostic functions:

1. Run EEPROM test.
2. Run Diagnostics on Board.
3. Run Diagnostics on Network.

Each option has its own display screen which shows the format and result of any diagnostic tests undertaken.

CHAPTER 4

Award BIOS Setup

This chapter describes how to set the card's BIOS configuration data.

4.1 AWARD BIOS Setup

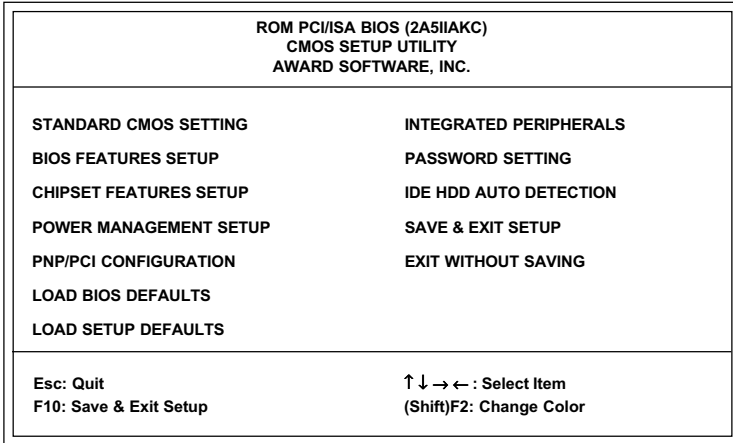

Figure 4-1: Setup program initial screen

Award's BIOS ROM has a built-in Setup program that allows users to modify the basic system configuration. This type of information is stored in battery-backed RAM so that it retains the Setup information when the power is turned off.

4.1.1 Entering setup

Turning on the computer and pressing immediately will allow you to enter Setup.

4.1.2 Standard CMOS setup

Choose the “STANDARD CMOS SETUP” option from the INITIAL SETUP SCREEN Menu, and the screen below is displayed. This standard Setup Menu allows users to configure system components such as date, time, hard disk drive, floppy drive, display, and memory.

ROM PCI/ISA BIOS (2A5IIAKC)
STANDARD CMOS SETUP
AWARD SOFTWARE, INC.

Date <mm:dd:yy> : Mon. Oct 7 1996																																																						
Time <hh:mm:ss> : 16 : 52 : 38																																																						
<table border="1"><thead><tr><th>HARD DISKS</th><th>TYPE</th><th>SIZE</th><th>CYLS</th><th>HEAD</th><th>PRECOMP</th><th>LANDZ</th><th>SECTOR</th><th>MODE</th></tr></thead><tbody><tr><td>Primary Master</td><td>:Auto</td><td>0</td><td>0</td><td>0</td><td>0</td><td>0</td><td>0</td><td>Auto</td></tr><tr><td>Primary Slave</td><td>:None</td><td>0</td><td>0</td><td>0</td><td>0</td><td>0</td><td>0</td><td>-----</td></tr><tr><td>Secondary Master</td><td>:Auto</td><td>0</td><td>0</td><td>0</td><td>0</td><td>0</td><td>0</td><td>Auto</td></tr><tr><td>Secondary Slave</td><td>:None</td><td>0</td><td>0</td><td>0</td><td>0</td><td>0</td><td>0</td><td>-----</td></tr></tbody></table>										HARD DISKS	TYPE	SIZE	CYLS	HEAD	PRECOMP	LANDZ	SECTOR	MODE	Primary Master	:Auto	0	0	0	0	0	0	Auto	Primary Slave	:None	0	0	0	0	0	0	-----	Secondary Master	:Auto	0	0	0	0	0	0	Auto	Secondary Slave	:None	0	0	0	0	0	0	-----
HARD DISKS	TYPE	SIZE	CYLS	HEAD	PRECOMP	LANDZ	SECTOR	MODE																																														
Primary Master	:Auto	0	0	0	0	0	0	Auto																																														
Primary Slave	:None	0	0	0	0	0	0	-----																																														
Secondary Master	:Auto	0	0	0	0	0	0	Auto																																														
Secondary Slave	:None	0	0	0	0	0	0	-----																																														
Drive A: 1.44M. 3.5 in.						Base Memory: 640K																																																
Drive B: None						Extended Memory: 15360K																																																
Video: EGA/VGA						Other Memory: 384K																																																
Halt On: All But Keyboard						Total Memory: 16384K																																																
ESC: Quit		↑↓→←: Select Item				PU/PD/+/-: Modify																																																
F1: Help		<Shift> F2: Change Color																																																				

Figure 4-2: CMOS setup screen

4.1.3 BIOS features setup

The “BIOS FEATURES SETUP” screen appears when choosing the BIOS FEATURES SETUP item from the CMOS SETUP UTILITY Menu. It allows the user to configure the MIC-3355 according to his particular requirements.

Below are some major items that are provided in the BIOS FEATURES SETUP screen:

ROM PCI/ISA BIOS (2A5IIAKC)
BIOS FEATURES SETUP
AWARD SOFTWARE, INC.

Virus Warning : Disabled	Video Bios Shadow : Enabled
CPU Internal Cache : Enabled	C8000-CBFFF Shadow : Disabled
External Cache : Enabled	CC000-CFFFF Shadow : Disabled
Quick Power On Self Test : Enabled	D0000-D3FFF Shadow : Disabled
Boot Sequence : C, A, SCSI	D4000-D7FFF Shadow : Disabled
Swap Floppy Drive : Disabled	D8000-DBFFF Shadow : Disabled
Boot Up Floppy Seek : Enabled	DC000-DFFFF Shadow : Disabled
Boot Up NumLock Status : On	
Boot Up System Speed : High	
Gate A20 Option : Fast	
Memory Parity Check : Disabled	
Typematic Rate Setting : Disabled	
Typematic Rate (Char/sec): 6	
Typematic Delay (Msec) : 250	
Security Option : Setup	
PCI/VGA Palette Snoop : Disabled	
OS Select for DRAM >64M : Non-OS2	
	Esc : Quit ↑↓→←: Select Item
	F1 : Help PU/PD/+/- : Modify
	F5 : Old Values <Shift>F2 : Color
	F6 : Load BIOS Defaults
	F7 : Load Setup Defaults

Figure 4-3: BIOS features setup screen

Virus Warning

During and after the system boots up, any attempt to write to the boot sector or partition table of the hard disk drive will halt the system. In this case, a warning message will be displayed. You can run the anti-virus program to locate the problem.

If Virus Warning is Disabled, no warning message will appear if anything attempts to access the boot sector or hard disk partition.

CPU Internal Cache/External Cache

Depending on the CPU/chipset design, these options can speed up memory access when enabled.

Quick Power On Self Test

This option speeds up the Power-On Self Test (POST) conducted as soon as the computer is turned on. When enabled, BIOS shortens or skips some of the items during the test. When disabled, normal POST procedures assumes.

Boot Sequence

This function determines the sequence in which the computer will search the drives for the disk operating system (i.e. DOS). The default value is "C, A, SCSI". The following options are available:

- A: Computer will boot from the A (floppy) disk drive
- C: Computer will boot from the C (hard) disk drive
- CDROM: Computer will boot from the CD-ROM disc drive
- SCSI: Computer will boot from the SCSI drive
- D: Computer will boot from the D drive
- E: Computer will boot from the E drive
- F: Computer will boot from the F drive
- LS120: Computer will boot from the LS-120 drive

Boot Up Floppy Seek

During POST, BIOS will determine if the floppy disk drive installed is 40 or 80 tracks. 360 KB type is 40 tracks while 720 KB, 1.2 MB, and 1.44 MB are all 80 tracks.

Enabled	BIOS searches the floppy drive to determine if it is 40 or 80 tracks. Note that BIOS cannot differentiate 720 KB, 1.2 MB, and 1.44 MB type drives as they are all 80 tracks.
Disabled	BIOS will not search for the floppy drive type by track number. Note that there will not be any warning message if the drive installed is 360 KB.

Boot Up NumLock Status

The default is “On”.

On	Keypad boots up to number keys.
----	---------------------------------

Off	Keypad boots up to arrow keys.
-----	--------------------------------

Boot Up System Speed

High	Sets the speed to high
------	------------------------

Low	Sets the speed to low
-----	-----------------------

IDE HDD Block Mode

Enabled	Enable IDE HDD Block Mode. BIOS will detect the block size of the HDD and send a block command automatically.
---------	---

Disabled	Disable IDE HDD Block Mode
----------	----------------------------

Gate A20 option

Normal	The A20 signal is controlled by the keyboard controller or chipset hardware
--------	---

Fast	Default: Fast. The A20 signal is controlled by Port 92 or chipset specific method.
------	--

Typematic Rate Setting

The typematic rate determines the characters per second accepted by the computer. Typematic Rate setting enables or disables the typematic rate.

Typematic Rate (Char/Sec)

BIOS accepts the following input values (character/second) for Typematic Rate: 6, 8, 10, 12, 15, 20, 24, 30.

Typematic Delay (msec)

When holding down a key, the Typematic Delay is the time interval between the appearance of the first and second characters. The input values (msec) for this category are: 250, 500, 750, 1000.

Security Option

This setting determines whether the system will boot if the password is denied, while limiting access to Setup.

System	The system will not boot, and access to Setup will be denied if the correct password is not entered at the prompt.
Setup	The system will boot, but access to Setup will be denied if the correct password is not entered at the prompt.

Note: To disable security, select PASSWORD SETTING in the main menu. At this point, you will be asked to enter a password. Simply hit the <ENTER> key to disable security. When security is disabled, the system will boot, and you can enter Setup freely.

OS Select for DRAM>64 MB

This setting is under OS/2 system.

Video BIOS Shadow

This determines whether video BIOS will be copied to RAM, which is optional according to the chipset design. When enabled, Video Shadow increases the video speed.

C8000 - CFFFF Shadow/DC000-DFFFF Shadow

These determine whether optional ROM will be copied to RAM in blocks of 16 KB.

Enabled	Optional shadow is enabled
Disabled	Optional shadow is disabled

4.1.4 CHIPSET features setup

By choosing the “CHIPSET FEATURES SETUP” option from the INITIAL SETUP SCREEN Menu, the screen below is displayed. This sample screen contains the manufacturer’s default values for the MIC-3355.

ROM PCI/ISA BIOS (2A5IIAKC)
CHIPSET FEATURES SETUP
AWARD SOFTWARE, INC.

Auto Configuration : Enabled	Memory Hole at 15M-16M : Disabled
L2 (WB) Tag Bit Length : 8 bits	VGA Shared Memory Size : 1 MB
SRAM Back to Back : Enabled	VGA Mem Clock (MHz) : 55
NA # Enable : Enabled	Linear Mode SRAM Support: Disabled
Starting Point of Paging : 1T	
Refresh Cycle Time (US) : 15.6	
RAS Pulse Width Refresh : 6T	
RAS Precharge Time : 4T	
RAS to CAS Delay : 4T	
RAMW# Assertion Timing: 3T	
SDRAM WR Retire Rate : X-2-2-2	
SDRAM Wait State Control : 1WS	
Enhanced Memory Write : Disabled	
Read Prefetch Memory RD: Enabled	
CPU to PCI Post Write : Disabled	Esc : Quit ↑↓→← : Select Item
CPU-PCI Burst Mem.WR : Disabled	F1 : Help PU/PD/+/- : Modify
ISA Bus Clock Frequency : PCI CLK/4	F5 : Old Values <Shift>F2 : Color
System BIOS Cacheable : Enabled	F6 : Load BIOS Defaults
Video BIOS Cacheable : Enabled	F7 : Load Setup Defaults

Figure 4-4: CHIPSET features setup screen

VGA Shared Memory Size

Share memory architecture can support 0.5 MB, 1MB, 1.5 MB, 2 MB, 3 MB, 3.5 MB and 4 MB of system memory.

4.1.5 Power management setup

The power management setup controls the CPU cards' "green" features. The following screen shows the manufacturer's default.

ROM PCI/ISA BIOS (2A5IIAKC)
POWER MANAGEMENT SETUP
AWARD SOFTWARE, INC.

Power Management	: Disable	VGA Activity	: Disabled
PM Control by APM	: Yes	IRQ3 (COM2)	: Enabled
Video Off Option	: Susp,Stby → Off	IRQ4 (COM1)	: Enabled
Video Off Method	: DPMS Supported	IRQ5 (LPT2)	: Enabled
Switch Function	: Break/Wake	IRQ6 (Floppy Disk)	: Enabled
Doze Speed (div by)	: 2	IRQ7 (LPT1)	: Enabled
Stdby Speed (div by)	: 3	IRQ8 (RTC Alarm)	: Disabled
Modem Use IRQ	: 3	IRQ9 (IRQ2 Redir)	: Enabled
Hot Key Power Off	: Disabled	IRQ10 (Reserved)	: Enabled
	PM Timers	IRQ11 (Reserved)	: Enabled
HDD Off After	: Disabled	IRQ12 (PS/2 Mouse)	: Enabled
Doze Mode	: Disabled	IRQ13 (Coprocessor)	: Enabled
Standby Mode	: Disabled	IRQ14 (Hard Disk)	: Enabled
Suspend Mode	: Disabled	IRQ15 (Reserved)	: Enabled
	PM Events		
COM Ports Activity	: Enabled	Esc : Quit	↵←→: Select Item
LPT Ports Activity	: Enabled	F1 : Help	PU/PD/+/- : Modify
HDD Ports Activity	: Enabled	F5 : Old Values	<Shift>F2 : Color
		F6 : Load BIOS Defaults	
		F7 : Load Setup Defaults	

Figure 4-5: Power management setup screen

Power Management

This option allows you to determine if the values in power management are disabled, user-defined, or predefined.

HDD Power Management

You can choose to turn the HDD off after a one of the time interval listed, or when the system is in Suspend mode. If in a power saving mode, any access to the HDD will wake it up.

Note: HDD will not power down if the Power Management option is disabled.

IRQ Activity

IRQ can be set independently. Activity on any enabled IRQ will wake up the system.

4.1.6 PCI configuration setup

ROM PCI/ISA BIOS (2A5IIAKC)
PNP/PCI CONFIGURATION
AWARD SOFTWARE, INC.

Resources Controlled By : Manual Reset Config. Data : Disabled	PCI IRQ Activated By : Level PCI IDE 2nd Channel : Enabled PCI IDE IRQ Map To : PCI-AUTO Primary IDE INT# : A Secondary IDE INT# : B
IRQ-3 assigned to : Legacy ISA IRQ-4 assigned to : Legacy ISA IRQ-5 assigned to : PCI/ISA PnP IRQ-7 assigned to : Legacy ISA IRQ-9 assigned to : PCI/ISA PnP IRQ-10 assigned to : PCI/ISA PnP IRQ-11 assigned to : PCI/ISA PnP IRQ-12 assigned to : PCI/ISA PnP IRQ-14 assigned to : Legacy ISA IRQ-15 assigned to : Legacy ISA DMA-0 assigned to : PCI/ISA PnP DMA-1 assigned to : PCI/ISA PnP DMA-3 assigned to : PCI/ISA PnP DMA-5 assigned to : PCI/ISA PnP DMA-6 assigned to : PCI/ISA PnP DMA-7 assigned to : PCI/ISA PnP	Esc : Quit ↑↓←→ : Select Item F1 : Help PU/PD/+/- : Modify F5 : Old Values <Shift>F2 : Color F6 : Load BIOS Defaults F7 : Load Setup Default

Figure 4-6: PCI configuration screen

4.1.7 Load BIOS defaults

“LOAD BIOS DEFAULTS” indicates the most appropriate values for the system parameters for minimum performance. These default values are loaded automatically if the stored record created by the Setup program becomes corrupted (and therefore unusable).

4.1.8 Load setup defaults

“LOAD SETUP DEFAULTS” loads the values required by the system for maximum performance.

4.1.9 Integrated Peripherals

ROM PCI/ISA BIOS (2A5IIAKC)
 INTEGRATED PERIPHERALS
 AWARD SOFTWARE, INC.

Internal PC/IDE : Both	Onboard Parallel Port : 378/IRQ7
IDE Primary Master PIO : Auto	Onboard Parallel Mode : ECP+EPP
IDE Primary Slave PIO : Auto	ECP Mode Use DMA : 3
IDE Secondary Master PIO : Auto	PS/2 Mouse function : Disabled
IDE Secondary Slave PIO : Auto	WDT Active when power on : Disabled
Primary Master Ultra DMA : Auto	USB Controller : Enabled
Primary Slave Ultra DMA : Auto	USB Keyboard Support : Disabled
Secondary Master Ultra DMA : Auto	Ethernet Boot ROM : Disabled
Secondary Slave Ultra DMA : Auto	
IDE Burst Mode : Enabled	
IDE Data Port Post Write : Enabled	
IDE HDD Block Mode : Enabled	
Onboard FDC Controller : Enabled	Esc : Quit F7 : Load Setup
Onboard Serial Port 1 : 3F8/IRQ4	F1 : Help Default
Onboard Serial Port 2 : 2F8/IRQ3	F5 : Old Values ↑↓→←: Select Item
IR Address Select : Disabled	F6 : Load BIOS PU/PD/+/- : Modify
	Defaults <Shift>F2 : Color

Figure 4-7: Integrated peripherals

Note: If you enable the IDE HDD block mode, the enhanced IDE driver will be enabled.

4.1.10 Password setting

To change, confirm, or disable the password, choose the “PASSWORD SETTING” option from the Setup main menu and press [Enter]. The password can be at most 8 characters long.

Remember, to enable this feature. You must first select the Security Option in the BIOS FEATURES SETUP to be either “Setup” or “System.” Pressing [Enter] again without typing any characters can disable the password setting function.

4.1.11 IDE HDD auto detection

“IDE HDD AUTO DETECTION” automatically self-detect for the correct hard disk type.

4.1.12 Save & exit setup

If you select this and press the [Enter] key, the values entered in the setup utilities will be recorded in the CMOS memory of the chipset. The microprocessor will check this every time you turn your system on and compare this to what it finds as it checks the system. This record is required for the system to operate.

4.1.13 Exit without saving

Selecting this option and pressing the [Enter] key lets you exit the Setup program without recording any new values or changing old ones.

APPENDIX A

Programming the Watchdog Timer

The MIC-3355 is equipped with a watchdog timer that resets the CPU or generates an interrupt if processing comes to a standstill for any reason. This feature ensures system reliability in standalone or unmanned environments.

A.1 Programming the Watchdog Timer

To program the watchdog timer, you must write a program which writes I/O port address 443 (hex). The output data is a value of time interval. The value range is from 01 (hex) to 3F (hex), and the related time interval is 1 sec. to 63 sec.

Data	Time Interval
01	1 sec.
02	2 sec.
03	3 sec.
04	4 sec.
•	•
•	•
•	•
3F	63 sec.

After data entry, your program must refresh the watchdog timer by rewriting the I/O port 443 (hex) while simultaneously setting it. When you want to disable the watchdog timer, your program should read I/O port 443 (hex).

The following example shows how you might program the watchdog timer in BASIC:

```
10      REM Watchdog timer example program
20      OUT &H443, data REM Start and restart the watchdog
30      GOSUB 1000 REM Your application task #1,
40      OUT &H443, data REM Reset the timer
50      GOSUB 2000 REM Your application task #2,
60      OUT &H443, data REM Reset the timer
70      X=INP (&H443) REM, Disable the watchdog timer
80      END

1000    REM Subroutine #1, your application task
.      .
.      .
.      .
1070   RETURN
2000    REM Subroutine #2, your application task
.      .
.      .
.      .
2090   RETURN
```

APPENDIX **B**

Pin Assignments

This appendix contains information of a detailed or specialized nature. It includes:

- CRT display connector
- RS-232/422/485 serial port connector
- Keyboard and mouse connector
- External keyboard connector
- Main power connector
- IDE connector
- RS-232 serial port connector
- Ethernet RJ-45 connector
- Floppy connector
- Parallel connector
- IR connector
- CompactPCI J3/P3 connector

B.1 CRT Display Connector (CN2)

Table B-1: MIC-3355 CRT display connector

Pin	Signal	Pin	Signal
1	RED	9	N/C
2	GREEN	10	GND
3	BLUE	11	N/C
4	N/C	12	DDAT
5	GND	13	H-SYNC
6	GND	14	V-SYNC
7	GND	15	DDCK
8	GND		

B.2 COM1 RS-232 Serial Port (CN6)

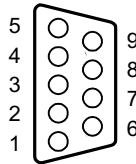

Table B-2: MIC-3355 COM1 RS-232 serial port

Pin	Signal
1	DCD
2	RXD
3	TXD
4	DTR
5	GND
6	DSR
7	RTS
8	CTS
9	RI

B.3 COM2 RS-232/422/485 Serial Port (CN6)

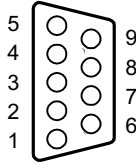

Table B-3: MIC-3355 COM2 RS-232/422/485 serial port

Pin	RS-232 port	RS-422 port	RS-485 port
1	DCD	TXD-	DATA-
2	RXD	TXD+	DATA+
3	TXD	RX+	N/C
4	DTR	RX-	N/C
5	GND	N/C	N/C
6	DSR	N/C	N/C
7	RTS	N/C	N/C
8	CTS	N/C	N/C
9	RI	N/C	N/C

B.4 Keyboard and Mouse Connector (CN1)

Table B-4: MIC-3355 keyboard connector

Pin	Signal
1	KB DATA
2	N/C
3	GND
4	V_{cc}
5	KB CLOCK
6	N/C

Table B-5: MIC-3355 mouse connector

Pin	Signal
1	N/C
2	MDAT
3	GND
4	V_{cc}
5	N/C
6	MCLOCK

B.5 Main Power Connector (CN7)

Table B-6: MIC-3355 main power connector

Pin	Signal
1	+12 V
2	GND
3	GND
4	V_{cc}

B.6 IDE Hard Drive Connector (CN10)

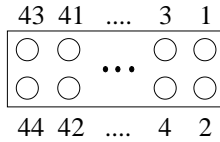

Table B-7: MIC-3355 IDE hard drive connector

Pin	Signal	Pin	Signal
1	IDE RESET*	2	GND
3	DATA 7	4	DATA 8
5	DATA 6	6	DATA 9
7	DATA 5	8	DATA 10
9	DATA 4	10	DATA 11
11	DATA 3	12	DATA 12
13	DATA 2	14	DATA 13
15	DATA 1	16	DATA 14
17	DATA 0	18	DATA 15
19	SIGNAL GND	20	N/C
21	N/C	22	GND
23	IO WRITE	24	GND
25	IO READ	26	GND
27	IO CHANNEL READY	28	N/C
29	HDACKO*	30	GND
31	IRQ14	32	IOCS16
33	ADDR 1	34	N/C
35	ADDR 0	36	ADDR 2
37	HARD DISK SELECT 0*	38	HARD DISK SELECT 1*
39	IDE ACTIVE*	40	GND
41	V _{cc}	42	V _{cc}
43	GND	44	N/C

* Low active

B.7 USB Connector (CN5)

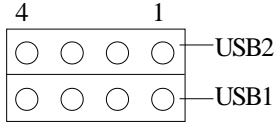

Table B-8: USB1/USB2 connector

Pin	USB1 Signal	Pin	USB2 Signal
1	+5 V	1	+5 V
2	DATA1-	2	DATA2-
3	DATA1+	3	DATA2+
4	GND	4	GND

B.8 CPU Fan Power Connector (CN8)

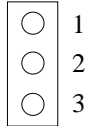

Table B-9: MIC-3355 CPU fan power connector

Pin	Signal
1	+5 V
2	GND
3	+12 V

B.9 Ethernet RJ-45 Connector (CN4)

Table B-10: MIC-3355 Ethernet RJ-45 connector

Pin	Signal	Pin	Signal
1	TD+	2	TD-
3	RD+	4	N/C
5	N/C	6	RD-
7	N/C	8	N/C

B.10 Floppy Drive Connector (CN9)



Table B-11: MIC-3355 floppy drive connector

Pin	Signal	Pin	Signal
1	V _{CC}	2	INDEX*
3	V _{CC}	4	DRVA*
5	V _{CC}	6	DSKCG*
7	N/C	8	N/C
9	N/C	10	MOTEA*
11	N/C	12	FDIR*
13	DVSL*	14	STEP*
15	GND	16	WDATA*
17	GND	18	WGATE*
19	GND	20	TK00*
21	GND	22	WPT*
23	GND	24	RDATA*
25	GND	26	SIDE1*

* Low active

B.11 Parallel Port Connector (CN6)

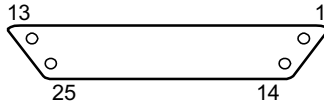

Table B-12: MIC-3355 parallel port connector

Pin	Signal
1	STB*
2	D0
3	D1
4	D2
5	D3
6	D4
7	D5
8	D6
9	D7
10	ACK*
11	BUSY
12	PE
13	SLCT
14	AFD*
15	ERR*
16	INIT*
17	SLIN*
18	GND
19	GND
20	GND
21	GND
22	GND
23	GND
24	GND
25	GND

B.12 System I/O Ports

Table B-13: System I/O ports

Addr. range (Hex)	Device
000-01F	DMA controller
020-021	Interrupt controller 1, master
022-023	Chipset address
040-05F	8254 timer
060-06F	8042 (keyboard controller)
070-07F	Real-time clock, non-maskable interrupt (NMI) mask
080-09F	DMA page register,
0A0-0BF	Interrupt controller 2
0C0-0DF	DMA controller
0F0	Clear math co-processor
0F1	Reset math co-processor
0F8-0FF	Math co-processor
1F0-1F8	Fixed disk
200-207	Game I/O
278-27F	Parallel printer port 2 (LPT 3)
2F8-2FF	Serial port 2
300-31F	Prototype card
360-36F	Reserved
378-37F	Parallel printer port 1 (LPT 2)
380-38F	SDLC, bisynchronous 2
3A0-3AF	Bisynchronous 1
3B0-3BF	Monochrome display and printer adapter(LPT1)
3C0-3CF	Reserved
3D0-3DF	Color/graphics monitor adapter
3F0-3F7	Diskette controller
3F8-3FF	Serial port 1

* PNP audio I/O map range from 220 ~ 250H (16 bytes)

MPU-401 select from 300 ~ 330H (2 bytes)

B.13 DMA Channel Assignments

Table B-14: DMA channel assignments

Channel	Function
0	Available
1	Available
2	Floppy disk (8-bit transfer)
3	Available
4	Cascade for DMA controller 1
5	Available
6	Available
7	Available

* Audio DMA select 0, 1 or 3

B.14 Interrupt Assignments

Table B-15: Interrupt assignments

Interrupt#	Interrupt source
IRQ 0	Interval timer
IRQ 1	Keyboard
IRQ 2	Interrupt from controller 2 (cascade)
IRQ 8	Real-time clock
IRQ 9	Cascaded to INT 0A (IRQ 2)
IRQ 10	Available
IRQ 11	Available
IRQ 12	PS/2 mouse
IRQ 13	INT from co-processor
IRQ 14	Fixed disk controller
IRQ 15	Available
IRQ 3	Serial communication port 2
IRQ 4	Serial communication port 1
IRQ 5	Parallel port 2
IRQ 6	Diskette controller (FDC)
IRQ 7	Parallel port 1 (print port)

* Ethernet function is auto-sensing

B.15 1st MB Memory Map

Table B-16: 1st MB memory map

Addr. range (Hex)	Device
F000h - FFFFh	System ROM
C800h - EFFFh	Unused
C000h - C7FFh	Expansion ROM
B800h - BFFFh	CGA/EGA/VGA text
B000h - B7FFh	Unused
A000h - AFFFh	EGA/VGA graphics
0000h - 9FFFh	Base memory

B.16 J3 connector pin assignments

Table B -16: J3 connector pin assignments

Pin	Row A	Row B	Row C	Row D	Row E
19	IDE2D3	IDE2D6	IDE2D2	IDE2D10	IDE2D14
18	IDE2D8	IDE2D5	IDE2D1	IDE2D11	IDE2D15
17	IDE2D9	IDE2D4	IDE2D0	IDE2D12	IDE2D13
16	IDE2D7	IDE2CS0-	IDE2IOR-	IDE2CS1-	IDE2RDY
15	IDE2DRQ	IDE2ACK-	IDE2SA2	IDE2IRQ	IDE2IOW-
14	GND	GND	IDE2SA1	GND	IDE2SA0
13	GND	GND	GND	GND	GND
12	IDE1D0	IDE1D2	IDE1D4	IDE1D7	GND
11	IDE1D1	IDE1D3	IDE1D8	IDE1D6	IDE1D12
10	IDE1D5	IDE1D9	IDE1D10	IDE1D11	IDE1D13
9	IDE1D15	IDE1D14	IDE1DRQ-	IDE1CS1-	IDE1IOR-
8	IRQ14	IDE1ACK-	N/C	IDE1SA2	IDE1IOW-
7	IDE1LED	GND	IDE1RST-	IDE1RDY	IDE1CS0-
6	GND	GND	GND	IDE1SA0	IDE1SA1
5	GND	GPIO5	IOCHK-	SDCLK1	SDDAT1
4	N/C	GND	GND	N/C	GND
3	DSKCHG-	MOTEA-	STEP-	SIDE1-	TK00-
2	DRVA-	MOTEB-	DVSL-	RDATA-	WPT-
1	INDEX-	DRVB-	FDIR-	WGATE-	WDATA-