



User Manual

ARK-1382

Trusted ePlatform Services

ADVANTECH

Copyright

The documentation and the software included with this product are copyrighted 2008 by Advantech Co., Ltd. All rights are reserved. Advantech Co., Ltd. reserves the right to make improvements in the products described in this manual at any time without notice. No part of this manual may be reproduced, copied, translated or transmitted in any form or by any means without the prior written permission of Advantech Co., Ltd. Information provided in this manual is intended to be accurate and reliable. However, Advantech Co., Ltd. assumes no responsibility for its use, nor for any infringements of the rights of third parties, which may result from its use.

Acknowledgements

Intel and Pentium are trademarks of Intel Corporation.

Microsoft Windows and MS-DOS are registered trademarks of Microsoft Corp.

All other product names or trademarks are properties of their respective owners.

Product Warranty (2 years)

Advantech warrants to you, the original purchaser, that each of its products will be free from defects in materials and workmanship for two years from the date of purchase.

This warranty does not apply to any products which have been repaired or altered by persons other than repair personnel authorized by Advantech, or which have been subject to misuse, abuse, accident or improper installation. Advantech assumes no liability under the terms of this warranty as a consequence of such events.

Because of Advantech's high quality-control standards and rigorous testing, most of our customers never need to use our repair service. If an Advantech product is defective, it will be repaired or replaced at no charge during the warranty period. For out-of-warranty repairs, you will be billed according to the cost of replacement materials, service time and freight. Please consult your dealer for more details.

If you think you have a defective product, follow these steps:

1. Collect all the information about the problem encountered. (For example, CPU speed, Advantech products used, other hardware and software used, etc.) Note anything abnormal and list any onscreen messages you get when the problem occurs.
2. Call your dealer and describe the problem. Please have your manual, product, and any helpful information readily available.
3. If your product is diagnosed as defective, obtain an RMA (return merchandise authorization) number from your dealer. This allows us to process your return more quickly.
4. Carefully pack the defective product, a fully-completed Repair and Replacement Order Card and a photocopy proof of purchase date (such as your sales receipt) in a shippable container. A product returned without proof of the purchase date is not eligible for warranty service.
5. Write the RMA number visibly on the outside of the package and ship it prepaid to your dealer.

Technical Support and Assistance

1. Visit the Advantech web site at www.advantech.com/support where you can find the latest information about the product.
2. Contact your distributor, sales representative, or Advantech's customer service center for technical support if you need additional assistance. Please have the following information ready before you call:
 - Product name and serial number
 - Description of your peripheral attachments
 - Description of your software (operating system, version, application software, etc.)
 - A complete description of the problem
 - The exact wording of any error messages

Packing List

Before installation, please ensure the following items have been shipped:

- Item Part Number
 - 1 ARK-1382 unit
 - 1 Utility CD
 - 1 Registration and 1 year Warranty card Rev. A
 - 1 2-Pole Phoenix to DC-Jack Power Cable 1700001394
 - 1 DVI-I to VGA connector
 - 1 WLAN antenna (ARK-1382W version)

Ordering information

Model Number Description

- ARK-1382-S0A1E
Intel ULV Celeron 1.06GHz, 2 x Serial ports, 1 x Giga LAN, 4 x USB 2.0, 2 x DVI-I ,Ultra Compact, Fanless Embedded Box Computer
- ARK-1382W-S0A1E

Optional accessories

1757000222 AC-to-DC Adapter DC19 V/3.42 A 65 W, with Phoenix Power Plug, 0 ~ 40° C for Home and Office Use

1750003222 802.11b/g 5dBi Dipole Antenna

1700001947 Power Cable 2-pin 180 cm, USA type

1700001948 Power Cable 2-pin 180 cm, Europe Type

1700001949 Power Cable 2-pin 180 cm, UK Type

9666K10000E DIN-Rail mounting kit for ARK-1000 series models

9666K10001E VESA mounting kit for ARK-1000 series models

Contents

Chapter 1	General Introduction	1
1.1	Introduction	2
1.2	Product Feature	3
1.2.1	General	3
1.2.2	Display	3
1.3	Chipset	4
1.3.1	Functional Specification	4
1.3.2	Mechanical Specification	7
	Figure 1.1 ARK-1382 Dimensions	7
1.3.3	Electrical Specification	8
1.3.4	Environmental Specification	8
Chapter 2	H/W Installation	9
2.1	Jumpers	10
2.1.1	Jumper Description	10
2.1.2	Jumper Setting	11
2.1.3	Locating Jumpers on the Board	13
2.2	Connectors	14
	Figure 2.1 ARK-1382 Front Side External I/O Connectors	14
	Figure 2.2 ARK-1382 Rear Side External I/O Connectors	14
2.2.1	ARK-1382 Front Side External I/O Connectors	15
	Figure 2.3 COM Connector	15
	Table 2.1: COM Standard Serial Port Pin Assignments	15
	Figure 2.4 USB Connector	15
	Table 2.2: USB Connector	15
	Figure 2.5 Ethernet Connector	16
	Table 2.3: RJ-45 Connector Pin Assignments	16
2.2.2	ARK-1382 Rear Side External I/O Connectors	16
	Figure 2.6 DVI-I Connector	17
	Table 2.4: DVI-I Connector Pin Assignment	17
	Figure 2.7 eSATA/USB Connector	17
	Table 2.5: eSATA/USB Connector Pin Assignment	17
	Figure 2.8 Power Input Connector	18
	Table 2.6: Power Connector Pin Assignments	18
Chapter 3	BIOS Operation	19
3.1	BIOS Introduction	20
3.2	BIOS Setup	20
3.2.1	Main Menu	21
3.2.2	Standard CMOS Features	22
3.2.3	Advanced BIOS Features	23
3.2.4	Advanced Chipset Features	25
3.2.5	Integrated Peripherals	26
3.2.6	Power Management Setup	27
3.2.7	PnP/PCI Configurations	29
3.2.8	PC Health Status	29
3.2.9	Frequency/Voltage Control	30
3.2.10	Load Optimized Defaults	30
3.2.11	Set Password	31
3.2.12	Save & Exit Setup	32
3.2.13	Exit Without Saving	32

Chapter 4	Full Disassembly Procedure	33
4.1	Introduction	34
Appendix A	Realtek RTL8111B/8111C Gigabit Boot Agent Configuration Menu	41
A.1	Realtek RTL8111B/8111C Gigabit Boot Agent Configuration Menu	42

Chapter 1

General Introduction

1.1 Introduction

ARK-1382 is a fanless and ultra compact system designed for a wide range of applications, such as Point Of Information system, flight information display system, and vehicle video player system.

ARK-1382 is designed with Intel Celeron M 423 @ 1.06 GHz processor, which provides excellent computing and multimedia performance. The system is equipped with 802.11b/g WLAN card and supports a wide range of input voltages from 9 V_{DC} to 35V_{DC}. Moreover, to fit different applications, ARK-1382 supports dual DVI-I independent display or dual VGA with clone mode. Despite the smallest size, ARK-1382 still supports 4 x USB 2.0, 1 x Giga LAN and 2 x COM ports, user can easily install the CF card via external CF socket.

The ARK-1382 Compact Embedded Computer is equipped with a solid state onboard CF card of up to 8 GB, so it easily passes 50 and 5 Grms shock and vibration tests.

ARK-1000 can be standalone, wall-mounted, DIN-rail mounted or VESA mounted. The series accepts a wide range of power supplies (DC power in) and comes in a footprint of only 189 x 41 x 130.6 mm (7.44" x 1.61" x 5.14"). The rugged cast aluminum case not only provides great protection from EMI, shock/vibration, cold and heat, but also passive cooling for quiet fanless operation.

1.2 Product Feature

1.2.1 General

CPU Intel/Celeron M ULV 423 at 1.06 GHz

- **System Chipset:** 945GM chipset 533 MHz FSB
- **BIOS:** AWARD® 4 Mbit Flash BIOS
- **System Memory:** 200-pin SODIMM socket, Supports ECC Double Data Rate (DDR2) 128 MB to 1 GB, DDR2 400/533 MHz
- **Power Management:** APM1.2, ACPI 2.0 support
- **SSD:** Supports CompactFlash® Card TYPE I/II (shared 1st IDE Channel) USB memory
- **Watchdog Timer:** Single chip Watchdog 255-level interval timer, setup by software
- **Expansion Interface:** 1 x miniPCI (Equipped with miniPCI WLAN card for ARK-1382W version)
- **Battery:** 3V/210 mAh
- **I/O Interface:** 2 x RS232/422/485 (default is RS-232, RS-422/485 by jumper setting)
- **USB:** 4 x USB 2.0 compliant Ports
- **Audio:** ALC203 AC97 surround stereo sound and dual output 2.2 W amplifier. Supports Line-out (Left and Right)
- **IrDA:** N/A
- **GPIO:** N/A
- **LAN Chipset:** Realtek 8111B PCI-E 10/100/1000 Base-T
- **Speed:** 10/100/1000 Mbps
- **Interface:** 1 x RJ45
- **Standard:** IEEE 802.3u 100Base-T

1.2.2 Display

- **Chipset:** Intel 945GM integrated 2D/3D graphic controller
- **Memory Size:** Supports Intel DVMT (Dynamic Video Memory Technology) 3.0 1 MB or 8 MB under system BIOS
- **Resolution:** CRT Display mode: pixel resolution up to 1600 x 1200 at 85-Hz and 1600 x 1200 at 75-Hz LCD Display mode:
- **Display Interface:** 2 x DVI-I, (VGA interface can be extended by connector)
- **Dual Independent:** DVI + DVI; DVI + VGA; (VGA +VGA only supports clone mode)

1.3 Chipset

1.3.1 Functional Specification

1.3.1.1 Processor

CPU supports:

- Supports 533 MHz Source-Synchronous Processor System Bus
- Processor ■ Supports Intel Celeron ULV423 at 1.06 GHZ CPU

35 mm *35 mm Micro-FCBGA Package.

For ARK-1382W-S0A1E, ARK-1382-S0A1E.

1.3.1.2 Chipset

NB: Intel 945GM GMCH chip supports:

- Supports for 400/533 MHz DDR2 SDRAM devices with max
- Supports maximum 1GB DDR SDRAM.
- Memory ■ SO-DIMM Socket on board: 200 pin SO-DIMM socket type x 1

It may have compatibility issue for 2 GB memory, please check with Advantech support team.

NB: Intel 945GM GMCH chip supports:

- Internal Graphics Features
- Dual display choose on board: Dual DVI, Dual VGA or DVI + VGA through OS Driver
 - DVI-I (CRT)
Integrated 400-MHz, Three 8-bit DACs provide the R,G and B signal to the monitor
Supports pixel resolution up to QXGA
Supports for Display Hot Plug
Supports Dual VGA Display via Video Separate Amplifier
 - DVI-I (DVI)
Supports DVI 1.0 for External Digital Monitor
Supports for Display Hot Plug
DVI Transmitter Support Digital Visual Interface (DVI) Transmitter up to 165M pixels/second
Supports Dual DVI Display Independently
- WinXP Extended desktop support for Dual DVI and DVI + VGA
- DVI-I Connector on board: DVI-I Combined Conn. 29P 90D(F) x 2

Graphic
and Video
Controllers

SB: Intel NH82801GHM chip supports:

- Supports PIO IDE transfers up to 16 Mbytes/sec
- IDE Interface ■ Supports Ultra ATA transfers to 100/66/33 Mbytes/sec
- The IDE interface integrates 16x32-bit buffers for optimal transfers
- Supports Compact Flash Card Type II Socket
- CF Socket on board: CF Type II 50P 90D(M) external connector x 1

	SB: Intel NH82801GHM chip supports:
Audio Link	<ul style="list-style-type: none"> ■ Supports Audio Codec'97, Revision 2.3 specification ■ Supports Link for Audio and Telephony CODECS ■ Supports Dual 2.2W Audio Amplifier Plus Stereo ■ RCA Jack on Board: 3P 90D(F) Red x 1 (Right Channel) ■ RCA Jack on Board: 3P 90D(F) White x 1 (Left Channel)

	SB: Intel NH82801GHM chip supports:
USB Interface	<ul style="list-style-type: none"> ■ USB host interface with support for 5 USB 2.0 ports (1 combined with eSATA) ■ All ports are High-Speed, Full-Speed, and Low-Speed capable ■ Supports legacy keyboard/mouse software ■ USB dual connector on board: USB conn 8P 90D(M) DIP x 2 ■ USB + eSATA connector on board : E-SATA+USB 11P 90D(M) DIP x 1

	SB: Intel NH82801GHM chip supports:
eSATA Interface	<ul style="list-style-type: none"> ■ Supports the Serial ATA specification Revision 1.0a ■ Supports several optional sections of Serial ATA II: Extensions to Serial ATA 1.0 Specification, Revision 1.0 ■ USB + eSATA connector on board : E-SATA+USB 11P 90D(M) DIP x 1 <p>Note: eSATA do not support PnP function.</p>

	SB: Intel NH82801GHM chip supports:
Mini PCI Interface	<ul style="list-style-type: none"> ■ Supports Mini PCI Interface 1.0 ■ Supports Mini PCI WLAN extension card use only ■ Supports 802.11A/B/G when use 9680005627 ■ Mini PCI socket: MINI PCI 124P 180D(F) SMD x 1 <p>(ARK-1382W version, miniPCI is equipped with WLAN miniPCI card)</p>

	SB: Intel NH82801GHM chip supports:
Power Management	<ul style="list-style-type: none"> ■ Supports ACPI 3.0 ■ ACPI Power Management Logic Support ■ Power connector: Plug-In block 2P DIP x 1

	SB: Intel NH82801GHM chip supports:
BIOS	<ul style="list-style-type: none"> ■ Low Pin Count (LPC) interface support ■ Firmware Hub (FWH) interface support ■ Phoenix 4M bit Flash BIOS, supports Plug & Play, APM 1.2/ACPI 1.1. ■ Socket: 32 pin PLCC socket x 1

1.3.1.3 Others (chipset)

	Super I/O: Winbond W83627HG supports:
Serial Ports	<ul style="list-style-type: none">■ 2 full function serial ports by Winbond W83627■ Supports IRQ Sharing among serial ports on XPE■ COM1: Supports to RS-232/422/485 and setting by Jumper■ COM2: Supports to RS-232/422/485 and setting by Jumper■ COM connector: D-SUB CON. 9P 90D(M)DIP x 2 <p>Note:RS-485 does not support Auto flow control. Please refer to CH2 for jumper setting.</p>
	Super I/O: Winbond W83627HG supports:
Thermal sensor	<ul style="list-style-type: none">■ Monitor the current CPU temperature■ Monitor the main power voltage
	LAN Chip: Realtek RTL8111B-GR supports:
LAN	<ul style="list-style-type: none">■ Supports PCI Express 1.0a■ Integrated 10/100/1000 transceiver■ Fully compliant with IEEE 802.3 compliant■ Supports Wake on LAN and remote wake-up■ Giga LAN Phone Jack on board: Phone Jack conn 8P 90D DIP x 1
	Audio Codec: Realtek ALC203 Amplifier: National LM4863
Audio	<ul style="list-style-type: none">■ Compliant with AC'97 2.3 specifications■ Supports to 20-bit DAC and 18-bit ADC resolution■ Supports Dual 2.2W Audio Amplifier Plus Stereo■ RCA Jack on Board: 3P 90D(F) Red x 1 (Right Channel)■ RCA Jack on Board: 3P 90D(F) White x 1 (Left Channel)
	DVI Transmitter: Chrontel CH7307C x 2
DVI	<ul style="list-style-type: none">■ Digital Visual Interface (DVI) Transmitter up to 165M pixels/second■ High-speed SDVO (1G~2Gbps) AC-coupled serial differential RGB inputs■ Complete Windows and DOS driver support■ DVI hot plug detection■ DVI-I Connector on board: DVI-I Combined Conn. 29P 90D(F) x 2
	Video Amplifier: Linear LT6557 x 2
VGA	<ul style="list-style-type: none">■ Supports Dual VGA Display via Video Separate Amplifier■ Share with DVI-I Connector on board: DVI-I Combined Conn. 29P 90D(F) x 2

	Battery support: CR2032
Battery backup	■ BATTERY 3V/210 mAh with WIRE x 1
	Wireless LAN Module Card: WM3210
WLAN (Optional)	■ Supports Mini PCI Interface 1.0
	■ Supports 802.11 b/g
	■ Mini PCI socket: MINI PCI 124P 180D(F) SMD x 1

1.3.2 Mechanical Specification

1.3.2.1 Dimension (mm)

189 x 41 x 130.6mm
(7.44" x 1.61" x 5.14")

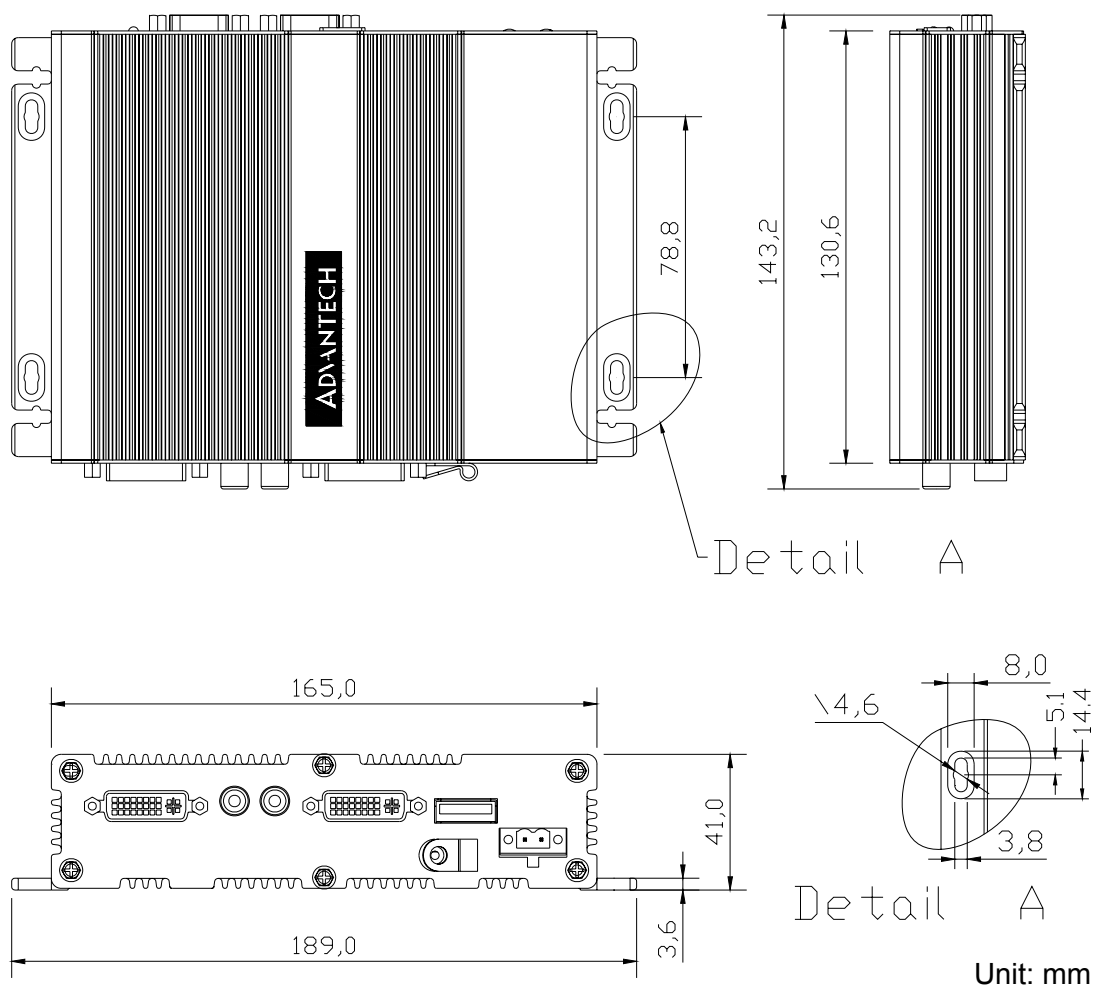

Figure 1.1 ARK-1382 Dimensions

1.3.2.2 Weight (g)

1.15 kg

1.3.3 Electrical Specification

1.3.3.1 Power Supply Voltage

Voltage requirement with Adaptor:

9 V-3.8 A ~ 35 V-1 A Adaptor

1.3.3.2 Power Supply Current

Supply Current (Maximum)

CPU : Intel Celeron ULV423 1.06 , RAM:533MHz 512GB DDR2 SDRAM

Adaptor	19 V
Dos	0.86 A
BIOS	NC
WINXP Idle	0.88 A
WINXP HCT11.0	NC
WINXP 3DMARK2001SE	NC
WINXP BURN IN TEST	1.16 A
Suspend	0.66 A

1.3.3.3 RTC Battery

Norminal Voltage: 3.0 V

Nominal discharge capacity: 210 mAh

1.3.4 Environmental Specification

1.3.4.1 Operating Temperature

The Intel® Celeron® is specified for proper operation when the junction temperature is within the specified range of 0° C to 100° C.

The Intel® 945GM chipset temperature runs at a maximum of 100° C. The Intel® ICH7 I/O Controller Hub 7 (82801GHM) case temperature runs at a maximum of 110° C.

The processor protects itself from catastrophic overheating by use of an internal thermal sensor at a temperature level of approximately 135° C.

Operating temperature: 0 ~ 60° C (32 ~ 140° F)

1.3.4.2 Operating Humidity

Operating Humidity: 0% ~ 90% Relative Humidity, non-condensing

1.3.4.3 Storage Temperature

Standard products (0 ~ 60° C)

Storage temperature: -20 ~ 70° C

1.3.4.4 Storage Humidity

Standard products (0 ~ 60° C)

Relative humidity: 95% @ 60° C

Chapter 2

H/W Installation

2.1 Jumpers

2.1.1 Jumper Description

Cards can be configured by setting jumpers. A jumper is a metal bridge used to close an electric circuit. It consists of two metal pins and a small metal clip (often protected by a plastic cover) that slides over the pins to connect them. To close a jumper, you connect the pins with the clip. To open a jumper, you remove the clip. Sometimes a jumper will have three pins, labeled 1, 2 and 3. In this case you would connect either pins 1 and 2, or 2 and 3.

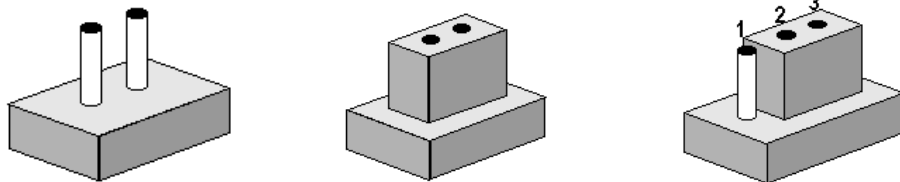

The jumper settings are schematically depicted in this manual as follows.



A pair of needle-nose pliers may be helpful when working with jumpers. If you have any doubts about the best hardware configuration for your application, contact your local distributor or sales representative before you make any changes.

Warning! *To avoid damaging the computer, always turn off the power supply before setting jumpers. Clear CMOS. Before turning on the power supply, set the jumper back to 3.0 V Battery On.*



2.1.2 Jumper Setting

2.1.2.1 COM1 Jumper

ARK-1382 series uses jumpers - JP1 ~ JP3 located on the internal carrier board for COM1 selecting the RS-232, RS422 and RS485.

JP1	
Close pins	Function
1-3	RS-232*
2-4	RS-232*
3-5	RS-422/RS-485
4-6	RS422/RS-485

(*): means default setting of the jumper/function.

JP2	
Close pins	Function
1-3	RS-232*
2-4	RS-232*
3-5	RS-422/RS-485
4-6	RS-422/RS-485

(*): means default setting of the jumper/function.

JP3	
Close pins	Function
1-2	RS-485
3-4	RS-422
5-6	RS-232*

(*): means default setting of the jumper/function.

2.1.2.2 COM2 Jumper

ARK-1382 uses jumpers - JP1 ~ JP3 located on the internal carrier board for COM2 selecting RS-232, RS422 and RS485.]

JP4	
Close pins	Function
1-3	RS-232*
2-4	RS-232*
3-5	RS-422/RS-485
4-6	RS422/RS-485

(*): means default setting of the jumper/function.

JP5	
Close pins	Function
1-3	RS-232*
2-4	RS-232*

3-5	RS-422/RS-485
-----	---------------

4-6	RS-422/RS-485
-----	---------------

(*): means default setting of the jumper/function.

JP6

Close pins	Function
-------------------	-----------------

1-2	RS-485
-----	--------

3-4	RS-422
-----	--------

5-6	RS-232*
-----	---------

(*): means default setting of the jumper/function.

2.1.2.3 CMOS Jumper (JP8)

ARK-1382 uses jumpers - JP8 located on the internal carrier board for selecting the CMOS for Clear or Normal status.

Close pins	Function
-------------------	-----------------

1-2	Clear CMOS
-----	------------

2-3	Normal*
-----	---------

(*): means default setting of the jumper/function.

2.1.3 Locating Jumpers on the Board

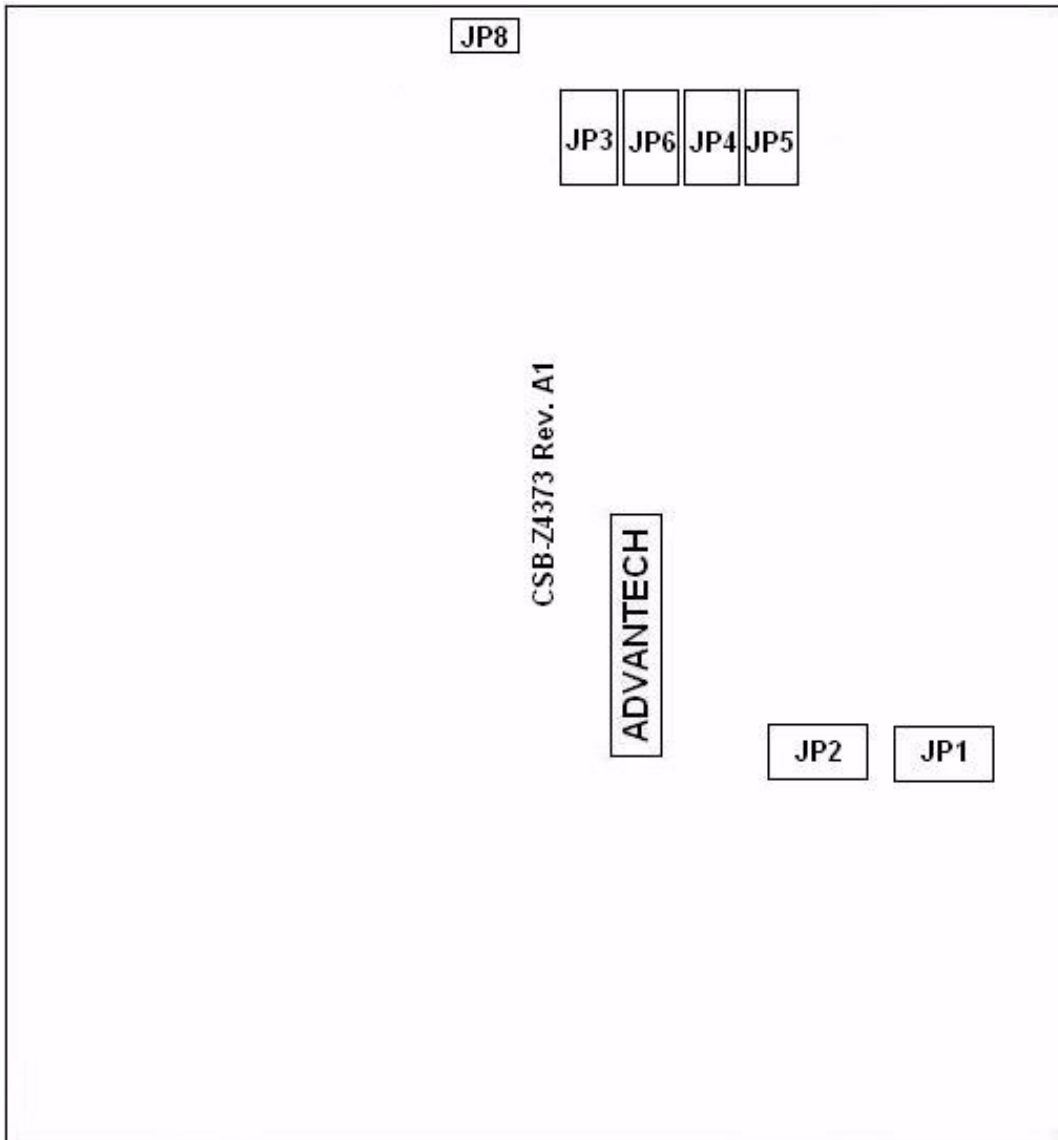

2.2 Connectors

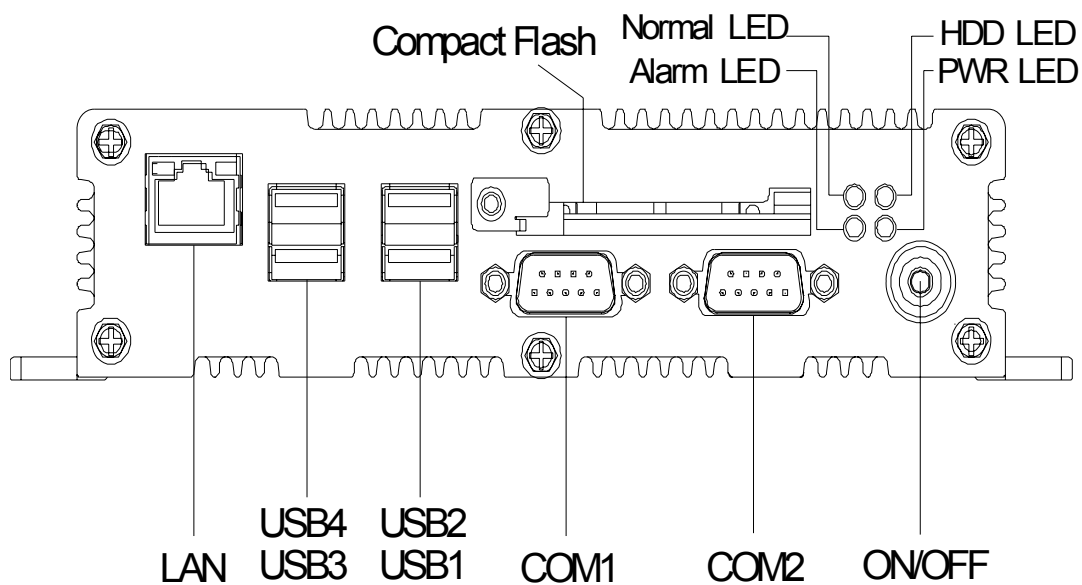

Figure 2.1 ARK-1382 Front Side External I/O Connectors

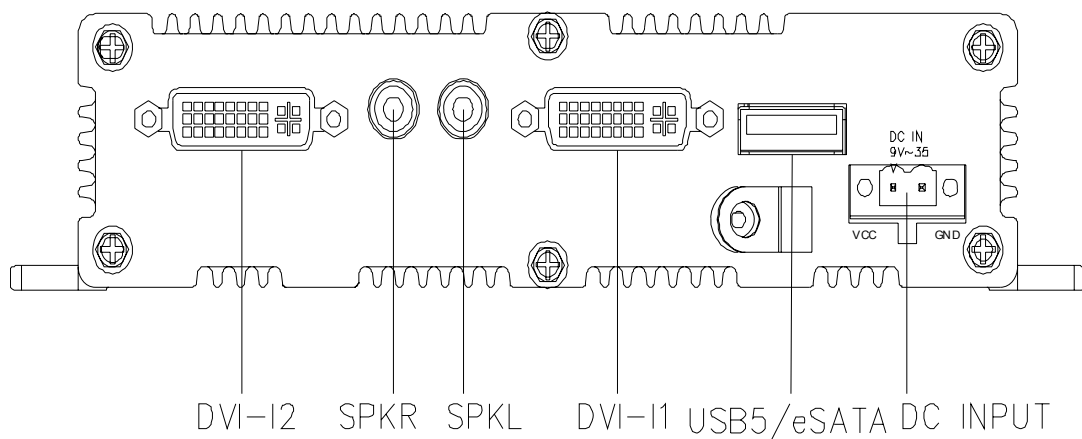

Figure 2.2 ARK-1382 Rear Side External I/O Connectors

2.2.1 ARK-1382 Front Side External I/O Connectors

2.2.1.1 COM Connector

ARK-1382 provides two D-sub 9-pin connectors, which offers RS-232/422/485 serial communication interface ports. Default setting is RS-232, if you want to use RS-422/485, you can find the jumper installation in Appendix and jumper setting in 2.12.

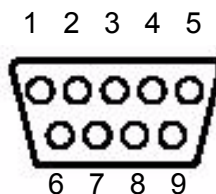

Figure 2.3 COM Connector

Table 2.1: COM Standard Serial Port Pin Assignments

	RS-232	RS-422	RS-485
Pin	Signal Name	Signal Name	Signal Name
1	DCD	Tx-	DATA-
2	RxD	Tx+	DATA+
3	TxD	Rx+	NC
4	DTR	Rx-	NC
5	GND	GND	GND
6	DSR	NC	NC
7	RTS	NC	NC
8	CTS	NC	NC
9	RI	NC	NC

Note: NC represents “No Connection”.

2.2.1.2 USB Connector

ARK-1382 provides four connectors for USB, which provide complete Plug & Play and hot swapping for up to 127 external devices. The USB interface are USB UHCI, Rev. 2.0 compliant. The USB interface can be disabled in the system BIOS setup. Please refer to Table. 2.2 for its pin assignments.

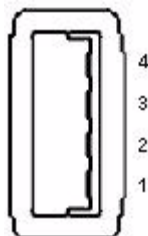

Figure 2.4 USB Connector

Table 2.2: USB Connector

Pin	Signal name	Pin	Signal name
1	VCC	2	USB_data-
3	USB_data+	4	GND

2.2.1.3 Ethernet Connector (LAN)

ARK-1382 is equipped with a Realtek RTL8111B-GR Ethernet controller that is fully compliant with IEEE 802.3u 10/100/1000Base-T CSMA/CD standards. The Ethernet port provides a standard RJ-45 jack connector with LED indicators on the front side to show its Active/Link status (Green LED) and Speed status (Yellow LED).

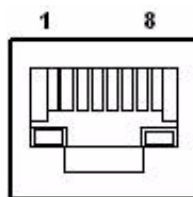

Figure 2.5 Ethernet Connector

Table 2.3: RJ-45 Connector Pin Assignments

Pin	10/100/1000BaseT Signal Name
1	TX+
2	TX-
3	RX+
4	NC
5	NC
6	RX-
7	NC
8	NC

2.2.1.4 Compact Flash Card

ARK-1382 is equipped with an external CF card.

2.2.1.5 Power ON/OFF Button

ARK-1382 comes with a Power On/Off button, that supports the dual functions of Soft Power -On/Off (Instant off or 4 sec. delay), and Suspend.

2.2.1.6 LED Indicators

There are four LEDs on ARK-1382 front metal face plate for indicating system status: PWR LED is for power status and flashes green in color; HDD LED is for Compact-Flash disk status, which flashes red in color; Normal LED detects if the internal temperature is under 75° C which flashes blue in color, but when the internal temperature is over 75° C, the Normal blue LED will not flash and the orange alarm LED will flash, which means the user must enhance the air flow to dissipate heat.

2.2.2 ARK-1382 Rear Side External I/O Connectors

2.2.2.1 DVI-I Connector

ARK-1382 provides dual DVI-I interface for dual independent display. For VGA monitor, you can use the DVI-I to VGA connector (see packing list P/N: 1654000446), supporting dual independent display for DVI + VGA. Please order the DVI-I to VGA connector separately (P/N: 1654000446).

Supports CRT mode: 1600 x 1200 @ 32 bpp @ 85 Hz and up to 32 MB shared memory.

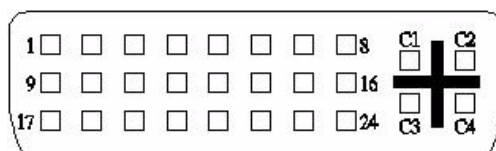

Figure 2.6 DVI-I Connector

Table 2.4: DVI-I Connector Pin Assignment

Pin	Signal Name	Pin	Signal name
1	TMDS-C2#	16	HP_DET
2	TMDS-C2	17	TMDS_C0#
3	GND	18	TMDS_C0
4	CRT_DDC_CLK	19	GND
5	CRT_DDC_DATA	20	-
6	MDVI_CLK	21	-
7	MDVI_DATA	22	GND
8	VGAVSY	23	TMDS_CK#
9	TMDS_C1#	24	TMDS_CK
10	TMDS_C1	C1	VGAR
11	GND	C2	VGAG
12	-	C3	VGAB
13	-	C4	VGHSY
14	VCC_DVI	C5	GND
15	GND		

2.2.2.2 Line out

ARK-1382 support left and right channel line out.

2.2.2.3 USB5/eSATA

ARK-1382 provides external SATA connector for external storage; if you do not need to use eSATA, the connector can be used as USB port.

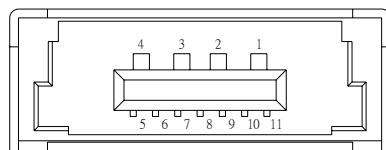

Figure 2.7 eSATA/USB Connector

Table 2.5: eSATA/USB Connector Pin Assignment

Pin	Signal name
1	VBUS
2	D-
3	D+
4	GND
5	GND
6	SATA_TX+
7	SATA_TX-

Table 2.5: eSATA/USB Connector Pin Assignment

8	GND
9	SATA_RX-
10	SATA_RX+
11	GND

2.2.2.4 Power Input Connector

ARK-1382 comes with a two pin header that carries 9 ~ 35 V_{DC} external power input.

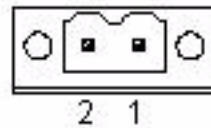

Figure 2.8 Power Input Connector

Table 2.6: Power Connector Pin Assignments

Pin	Signal Name
1	GND
2	+9 ~ 35 V _{DC}

Chapter 3

BIOS Operation

Sections include:

- BIOS Introduction
- BIOS Setup

3.1 BIOS Introduction

Advantech provides a full-featured AwardBIOS 6.0 which delivers the superior performance, compatibility, and functionality that manufacturers of Industrial PC and Embedded boards demand; its many options and extensions let you customize your products to a wide range of applications and target markets.

The modular, adaptable AwardBIOS 6.0 supports the broadest range of processors, third-party peripherals and popular chipsets including: Intel CPUs from 386 through to Pentium, and AMD Geode to K7 and K8; as well as nVidia and VIA processors. Advantech also provides utilities to easily select and install features that suit the customers' own designs.

3.2 BIOS Setup

The ARK-1382 series has a built-in AwardBIOS with a CMOS SETUP utility which allows the user to configure their required settings or to activate certain system features.

The CMOS SETUP saves the configuration in the CMOS RAM on the motherboard. When the power is turned off, the onboard battery supplies the necessary power to the CMOS RAM for configuration settings to be retained.

When the power is turned on, press the button during the BIOS POST (Power-On Self Test) boot up stage; this will take you to CMOS SETUP.

CONTROL KEYS

< ↑ >< ↓ >< ← >< → > Move item selection

<Enter> Select Item - View submenu or options

<Esc> Main Menu - Quit and do not save changes into CMOS
Sub Menu - Exit current page and return to higher menu

<Page Up/+> Increase the numeric value or make changes

<Page Down/-> Decrease the numeric value or make changes

<F1> General help - for Setup Sub Menu

<F2> Item Help

<F5> Load Previous Values

<F7> Load Optimized Default

<F10> Save all CMOS changes

3.2.1 Main Menu

During bootup, press to enter the AwardBIOS CMOS Setup Utility; the Main Menu will appear on the screen. Use arrow keys to select among the items and press <Enter> to accept or enter a sub-menu.

- **Standard CMOS Features**
This setup page includes all the items in the standard compatible BIOS.
- **Advanced BIOS Features**
This setup page includes all the Award BIOS enhanced features.
- **Advanced Chipset Features**
This setup page includes all the chipset configuration features.
- **Integrated Peripherals**
This setup page includes all onboard peripheral devices.
- **Power Management Setup**
This setup page includes all the Power Management features.
- **PnP/PCI Configurations**
This setup page includes PnP OS and PCI device configuration.
- **PC Health Status**
This page includes CPU overheat protection setting, and reports system temperature, CPU temperature, fan speeds, and system voltages.
- **Frequency/Voltage Control**
This setup page includes settings for PCI clock signal, spread spectrum, and CPU host/SRC/PCI clock speeds.
- **Load Optimized Defaults**
This option loads values that are optimized for stable, average performance.
- **Set Password**
Establish, change, or disable passwords.
- **Save & Exit Setup**
Save CMOS value settings to CMOS and exit BIOS setup.
- **Exit Without Saving**
Abandon all CMOS value changes and exit BIOS setup.

3.2.2 Standard CMOS Features

- Date
 - The date format is <Weekday>, <Month>, <Day>, <Year>.
 - Weekday From Sun to Sat, determined and displayed by the BIOS only
 - Month From Jan to Dec
 - Day From 1 to 31
 - Year From 1999 through 2098
- Time
 - The time format is in <hours> : <minutes> : <seconds>, based on 24-hour time
- IDE Channel 0 Master/Slave
 - IDE HDD Auto-Detection. Press "Enter" for automatic device detection.
- IDE Channel 1 Master/Slave
 - IDE HDD Auto-Detection. Press "Enter" for automatic device detection.
- Video
 - The item determines that VGA display support type.
 - EGA/VGA Support VGA color mode
 - CGA 40 Support VGA color mode
 - CGA 80 Support VGA color mode
 - MONO Support VGA mono mode
- Halt on
 - This item determines whether the computer bootup process will stop if an error is detected during power up.
 - No Errors The system boot sequence will not stop for any error.
 - All Errors Whenever the BIOS detects a non-fatal error the system will stop.
 - All, but Keyboard The system boot sequence will not stop for a keyboard error, but it will stop for all other errors. (Default value)
 - All, but Diskette The system boot sequence will not stop for a disk error, but it will stop for all other errors.
 - All, but Disk/Key The system boot sequence will not stop for a keyboard or disk error, but it will stop for all other errors.
- Base Memory
 - The BIOS POST displays the amount of base (or conventional) memory installed in the system.
- Extended Memory
 - The BIOS POST displays the amount of extended memory (above 1 MB in the CPU's memory address map) installed in the system.
- Total Memory
 - This item displays the total system memory size.

3.2.3 Advanced BIOS Features

- **Blank Boot** [Disabled] (* Advantech feature enhancement)
When enabled, the system displays a blank screen during the BIOS POST stage.
- **POST Beep** [Enabled] (* Advantech feature enhancement)
When enabled, the system emits beep sounds during the BIOS POST stage.
- **CPU Feature**
This item allows users to adjust CPU features, CPU ratio, VID. Thermal and special features like XD flag.
- **Hard Disk Boot Priority**
This item allows users to select the boot sequence for system hard drive devices - HDD, SCSI, RAID.
- **USB Boot Priority**
This item allows user to select boot sequence for USB device Boot.
- **Virus Warning** [Disabled]
This item allows users to choose or disable the virus warning feature for IDE Hard Disk boot sector protection.
- **Quick Power On Self Test** [Enabled]
This field speeds up the Power-On Self Test (POST) routine by skipping the second, third, and fourth re-tests. Default setting is enabled.
- **First / Second / Third / Other Boot Drive**
 - First [USB Device]
 - Second [USB-CDROM]
 - Third [Hard Disk]
 - Other [Enabled]
 - Hard Disk Select boot device priority by CF.
 - USB Device Select boot device priority by USB Device.
 - USB-FDD Select boot device priority by USB-FDD.
 - USB-CDROM Select boot device priority by USB-CDROM.
 - LAN Select boot device priority by LAN.
 - Disabled Disable this boot function.
- **Boot Up NumLock Status** [On]
When enabled, the keyboard keypad boots up in number mode. When disabled, the keypad boots up in cursor control mode (arrow mode).
- **Gate A20 Optio** [Fast]
This item enables the user to switch A20 control by port 92 or not.
- **Typematic Rate Setting**
This item enables users to enable or disable typematic action. When enabled, they can set the two typematic controls items.
These fields control the speeds of:
 - **Typematic Rate (Chars/Sec)**
This item controls the speed at which the system registers repeated keystrokes.
The eight settings are 6, 8, 10, 12, 15, 20, 24 and 30.

- Typematic Delay (Msec)

This item sets the keypress delay before typematic repetition kicks in. The four delay options are 250, 500, 750 and 1000.

Note! *These typematic settings apply to systems that communicate with the keyboard via BIOS. For Windows systems, typematic settings are controlled by keyboard driver settings in Windows Control Panel.*



- Security Option [Setup]
 - System System requires password both for bootup and for access to the Setup page.
 - Setup System requires password only for access to the Setup page, not for bootup. (Default value)
- APIC Mode[Enabled]

This item allows user to enabled of disabled “Advanced Programmable Interrupt Controller”. APIC is implemented in the motherboard and must be supported by the operating system, and it extends the number of IRQ's available.
- MPS Version Control for OS [1.4]

This item sets the system multiprocessor specification version.
- OS Select For DRAM > 64 M [Non-OS2]

Select OS2 only if the system is running OS/2 with greater than 64 MB of RAM on the system.
- Full Screen Logo Show [Enabled]

Shows full screen logo during POST stage; logo image can be customized.
- Small Logo (EPA) Show [Disable]

Shows EPA logo during system POST stage.
- Summary Screen Show [Enabled]

Shows system status on summary screen page.

3.2.4 Advanced Chipset Features

Note!  This “Advanced Chipset Features” screen controls the configuration of the board’s chipset; this page is developed to be chipset independent for fine-tuning system performance. It is strongly recommended that only technical users make changes to the default settings.

- **DRAM Timing Selectable** [By SPD]
This item enables users to set optimal timings for items 2 through to 5. The system default setting of “By SPD” ensures the system runs with stable and optimal performance.
- **CAS Latency Time** [Auto]
This item enables users to set the timing delay in clock cycles before the SDRAM starts a read command after receiving it.
- **DRAM RAS# to CAS# Delay** [Auto]
This item enables users to set the timing of the transition from RAS (Row Address Strobe) to CAS (Column Address Strobe) as both rows and columns are separately addressed shortly after DRAM is refreshed.
- **DRAM RAS# Precharge** [Auto]
This item enables users to set the DRAM RAS# precharge timing. System default is set to “Auto” to reference the data from SPD ROM.
- **Prechage delay (tRAS)** [Auto]
This item allows user to adjust memory precharge time.
- **System Memory Frequency** [Auto]
This item allows user to adjust memory frequency to improvement performance.
- **SLP_S4# Assertion Width** [1 to 2 sec.]
This item allows user to adjust SLP_S4# signal. This field indicates the minimum assertion width of the SLP_S4# signal to ensure that the DRAMs have been safely power-cycled.
- **System BIOS Cacheable** [Enabled]
This item allows the system BIOS to be cached to allow faster execution and better performance.
- **Video BIOS Cacheable** [Disabled]
This item allows the video BIOS to be cached to allow faster execution and better performance.
- **Memory Hole At 15 M-16 M** [Disabled]
This item reserves 15 MB-16 MB memory address space to ISA expansion cards that specifically require the setting. Memory from 15 MB-16 MB will be unavailable to the system because only expansion cards can access memory in this area.
- **PEG/Onboard VGA Control** [Auto]
This item allows the user to select whether onboard graphics processor or the PCI Express card.
- **On-Chip Frame Buffer Size** [8 MB]
This item allows the user to choose Frame Buffer Size. BIOS default value is set to 8 MB.

- DVMT Mode [DVMT]
This item allows the user to adjust Intel's Dynamic Video Memory Technology (DVMT). Bios provide three option to choose (DVMT, FIXED and Both).
- DVMT/FIXED Memory Size [128MB]
This item allows the user to adjust DVMT/FIXED graphics memory size.
- Boot Display [VBIOS Default]
This item allows the user to decide that display mode.

3.2.5 Integrated Peripherals

Note!  This "Integrated Peripherals" screen controls the configuration of the board's chipset, including controls for: IDE, ATA, SATA, USB, AC97, MC97 and Super IO and sensor devices; this section is developed to be chipset independent.

- OnChip IDE Device
This item enables users to set the OnChip IDE device status, including enabling IDE devices and setting PIO and DMA access mode, plus some new chipset support for SATA devices (Serial-ATA).
 - IDE HDD Block Mode [Enabled]
This item allows the users to enable for automatic detection of optimal number of block read/writes per sector the drive can support if IDE Hard Driver supports block mode
 - IDE DMA transfer access Mode [Enabled]
This item allows the user to enable the DMA transfer access.
 - On-Chip Primary / Secondary PCI IDE [Enabled]
This item allows the user to select the PIO or UDMA mode.
 - SATA Mode [IDE]
The item allows the users to support IDE mode.
 - SATA Port Speed Settings [Disabled]
This item allows the users to select SATA port speed.
- Onboard Device
This item enables users to set the Onboard device status, including enabling USB, AC97, MC97 and LAN devices.
- Super IO Device
This item enables users to set the Super IO device status, including enabling Floppy, COM, LPT, IR and control for GPIO and Power Fail status.
 - Onboard Serial Port 1 [3F8/IRQ4]
This item allows the user to change the COM 1 address and IRQ. BIOS default value suggest to .3F8/IRQ4.
 - Onboard Serial Port 2 [2F8/IRQ3]
This item allows the user to chang13 the COM 2 address and IRQ. BIOS default value suggest to .2F8/IRQ3.
 - UART Mode Select [Normal]
This item allows the selection for the mode of operation of the serial port.
 - Onboard Parallel Port [378/IRQ7]
This item allows the user to change the parallel port address. BIOS default value is set to .378/IRQ7..

- Parallel Port Mode [SPP]
This item allows the user to change the parallel port mode. The user can choose .SPP., .EPP., .±ECP. and .ECP+EPP.; SPP (Standard Parallel Port); ECP (Extended Capabilities Port); and EPP (Enhanced Parallel Port). The BIOS default value is set to .Normal..
- EPP Mode Select [EPP1.7]
This item allows the user to change the EPP Mode for the parallel port. The BIOS default value is set to .EPP1.7..
- ECP Mode Use DMA [3]
This item allows the user to change the DMA channel for the parallel port. The BIOS default value is set to 3.
- PWRON After PWR-Fail [Off]
This item allows user to select system power status after power loss.

3.2.6 Power Management Setup

Note!  This “Power Management Setup” screen configures the system to most effectively save energy while operating in a manner consistent with your computer use.

- ACPI Function [Enabled]
This item defines the ACPI (Advanced Configuration and Power Interface) feature that makes hardware status information available to the operating system, and communicates PC and system device information for improving power management.
- ACPI Suspend Type [S1 (POS)]
This item allows users to select sleep state when the system is in suspend mode.
 - S1(POS) Suspend mode is equivalent to a software power down.
 - S3(STR) The system shuts down with the exception of a refresh current to the system memory.
 - S1 & S3 This item is support two mode be selection by software.
- Run VGA BIOS if S3 Resume [Auto]
This item allows the system to reinitialize the VGA BIOS after the system has resumed from ACPI S3 mode.
- Power Management Option [User Define]
This item allows user to select system power saving mode.
 - Min Saving Minimum power management. Suspend Mode=1 hr.
 - Max Saving Maximum power management. Suspend Mode=1 min.
 - User Define Allows user to set each mode individually. Suspend Mode= Disabled or 1 min ~1 hr.
- Video Off Method [DPMS]
This item allows users to determine the manner in which the monitor is blanked.
 - V/H SYNC+Blank This option will cause the system to turn off vertical and horizontal synchronization ports and write blanks to the video buffer.
 - Blank Screen This option only writes blanks to the video buffer.
 - DPMS Initial displays power management signaling.

- Video Off In Suspend [Yes]
This item allows users to turn off video when entering suspend mode.
- Suspend Type [Stop Grant]
This item allows users to determine the suspend type.
- Modem use IRQ [3]
This item allows users to determine which IRQ the MODEM can use.
- Suspend Mode [Disabled]
Shows the time of system inactivity before all devices except the CPU will be shut off.
- HDD Power Down Mode [Disabled]
Shows the time of system inactivity before the hard disk drive will be powered down.
- Soft-Off by PWR-BTTN [Instant-Off]
This item allows users to define power button functions.
 - Instant-Off Press power button to power-off instantly.
 - Delay 4 Sec Press power button for 4 seconds to power-off.
- Energy Lake Function [Disabled]
- Wake-Up by PCI card [Enabled]
This item allows users to permit PCI cards to wake up the system from suspend mode.
- Power On by Ring [Enabled]
This item allows users to permit the system to power-on from a modem ring.
- USB KB Wake-Up From S3 [Disabled]
This item allows users to use a USB keyboard to wake up the system from power saving mode.
- Resume by Alarm [Disabled]
This item allows users to power on the system at a specified date and/or time.
 - Disabled Disable this function.
 - Enabled Enable alarm function to power on system
 - Data (of month) Alarm1-31
 - Time (HH:MM:SS) Alarm(0-23) : (0-59) : 0-59)

3.2.7 PnP/PCI Configurations

Note! This “PnP/PCI Configurations” screen is setting up the IRQ and DMA (both PnP and PCI bus assignments.)



- Init Display First [Onboard]
This item allow user to select initial display mode, optional item include PCI slot and Onboard.
- Reset Configuration Data [Disabled]
This item allows users to clear any PnP configuration data stored in the BIOS.
- Resources Controlled By [Auto (ESCD)]
 - IRQ Resources
This item allows you respectively assign an interruptive type for IRQ-3, 4, 5, 7, 9, 10, 11, 12, 14, and 15.
- PCI VGA Palette Snoop [Disabled]
The item is designed to solve problems caused by some non-standard VGA cards. A built-in VGA system does not need this function.
- INT Pin 1~8 Assignment [Auto]
The interrupt request (IRQ) line assigned to a device connected to the PCI interface on your system.
- Maximum payload Size [128]
The item allows user to adjust maximum TLP (Transaction Layer Packet) payload size.

3.2.8 PC Health Status

Note! This “PC Health Status” screen reports the Thermal, FAN and Voltage status of the board. This page is developed to be chipset independent.



- Shutdown Temperature [Disabled]
This item allow user to set the temperature to notify the ACPI OS to shutdown the system.
- Current System/CPU Temp [Show Only]
This item displays current system and CPU temperature.
- 2.5 V / 3.3 V / 5 V / 12 V and VCore [Show Only]
This item displays current CPU and system Voltage.

3.2.9 Frequency/Voltage Control

Note!  *NOTE: This “Frequency/Voltage Control” option controls the CPU Host and PCI frequency, this section is CPU and Chipset independent, some items will show up when you install a processor which supports this function.*

- Auto Detect PCI Clk [Enabled]
This item enables users to set the PCI Clock by system automatic detection or by manual.
- Spread Spectrum [Enabled]
This item enables users to set the spread spectrum modulation.

3.2.10 Load Optimized Defaults

Note!  *Load Optimized Defaults loads the default system values directly from ROM. If the stored record created by the Setup program should ever become corrupted (and therefore unusable). These defaults will load automatically when you turn the ARK-1382 Series system on.*

3.2.11 Set Password

Note! *To enable this feature, you should first go to the Advanced BIOS Features menu, choose the Security Option, and select either Setup or System, depending on what you want password protected. Setup requires the password only to enter Setup. System requires the password every time the system boots, and to enter Setup. A password may be at most 8 characters long.*



To Establish Password

1. Choose Set Password from the CMOS Setup Utility main menu and press <Enter>.
2. When you see "Enter Password", enter the desired password and press <Enter>.
3. At the "Confirm Password" prompt, retype the desired password, then press <Enter>.
4. Select Save to CMOS and EXIT, type <Y>, then <Enter>.

To Change Password

1. Choose Set Password from the CMOS Setup Utility main menu and press <Enter>.
2. When you see "Enter Password", enter the existing password and press <Enter>.
3. You will see "Confirm Password". Type it again, and press <Enter>.
4. Select Set Password again, and at the "Enter Password" prompt, enter the new password and press <Enter>.
5. At the "Confirm Password" prompt, retype the new password, and press <Enter>.
6. Select Save to CMOS and EXIT, type <Y>, then <Enter>.

To Disable Password

1. Choose Set Password from the CMOS Setup Utility main menu and press <Enter>.
2. When you see "Enter Password", enter the existing password and press <Enter>.
3. You will see "Confirm Password". Type it again, and press <Enter>.
4. Select Set Password again, and at the "Enter Password" prompt, don't enter anything; just press <Enter>.
5. At the "Confirm Password" prompt, again, don't type in anything; just press <Enter>.
6. Select Save to CMOS and EXIT, type <Y>, then <Enter>.

3.2.12 Save & Exit Setup

Note! Type "Y" will quit the BIOS Setup Utility and save user setup value to CMOS.



Type "N" will return to BIOS Setup Utility.

3.2.13 Exit Without Saving

Note! Type "Y" will quit the BIOS Setup Utility without saving to CMOS.



Type "N" will return to BIOS Setup Utility.

Chapter 4

Full Disassembly Procedure

4.1 Introduction

If you want to completely disassemble ARK-1382, follow the step-by-step procedures below. Users should be aware that Advantech Co., Ltd. takes no responsibility whatsoever for any problems or damage caused by the user disassembly of ARK-1382. Make sure the power cord of ARK-1382 is unplugged before you start disassembly.

1. Unscrew the 4 screws on the bottom side.

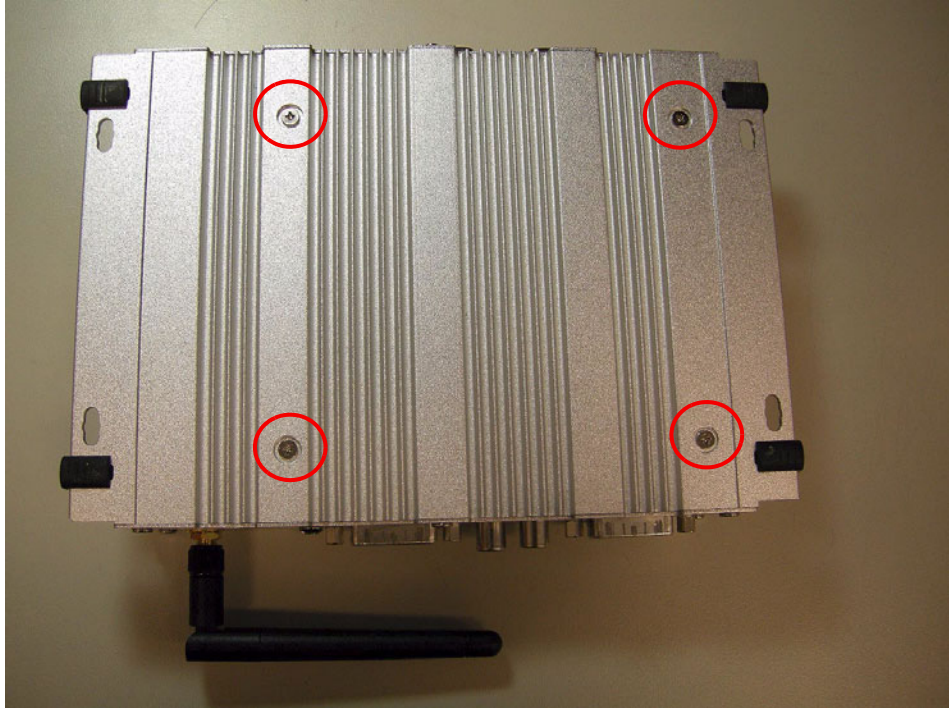

2. Unscrew the 6 screws on the front side frame.

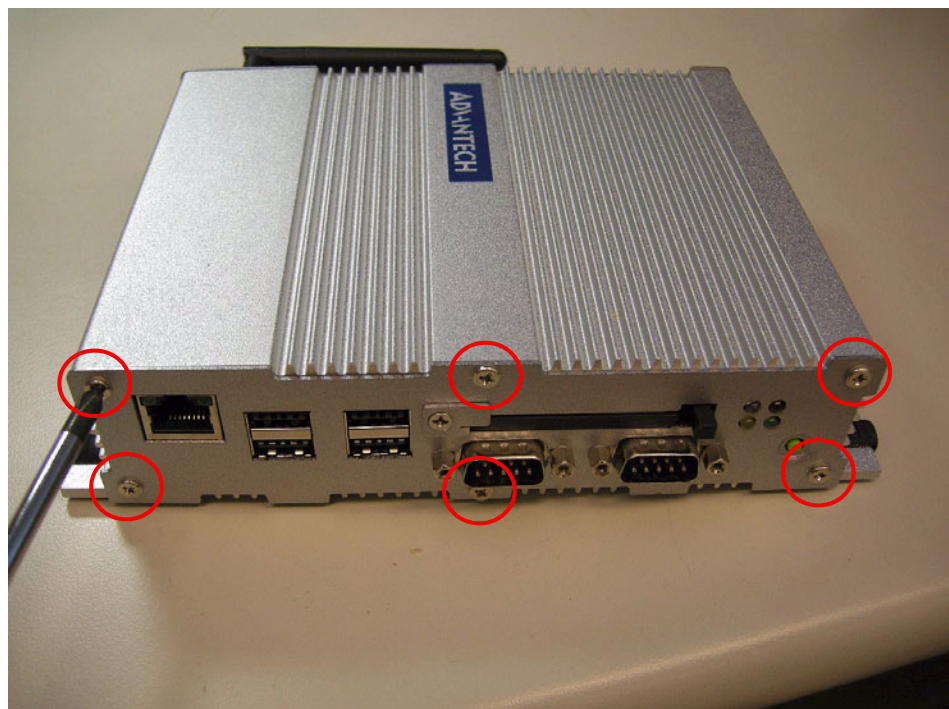

3. Unscrew the single screw on the front face plate.



4. Unscrew the 4 Hex-bolt on the front face plate.



5. Unscrew the 6 screws on the rear side frame.

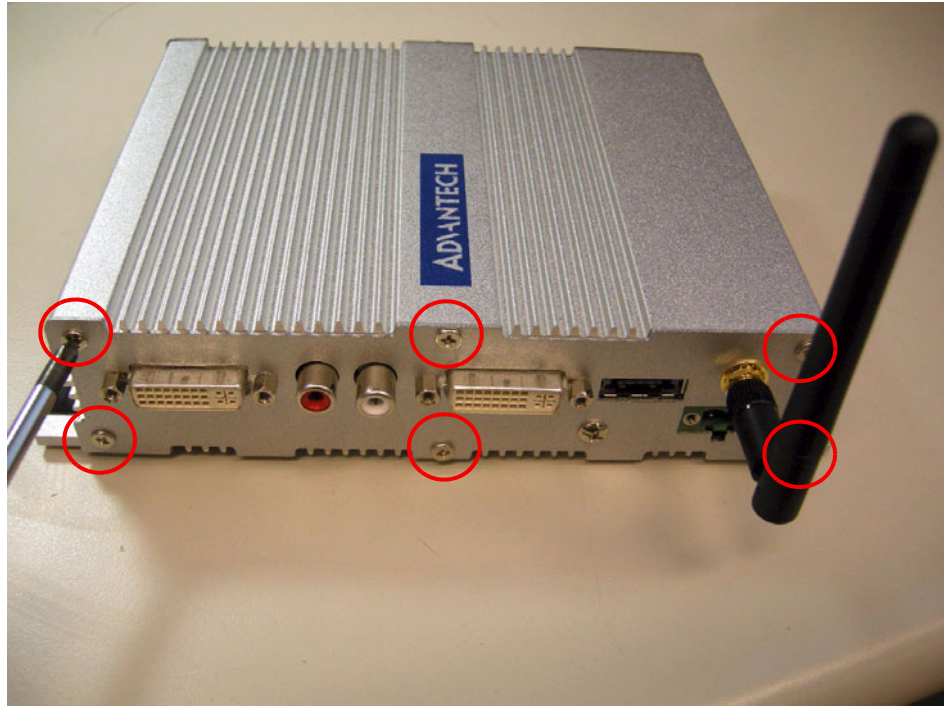

6. Unscrew the 4 Hex-bolt on the rear face plate.

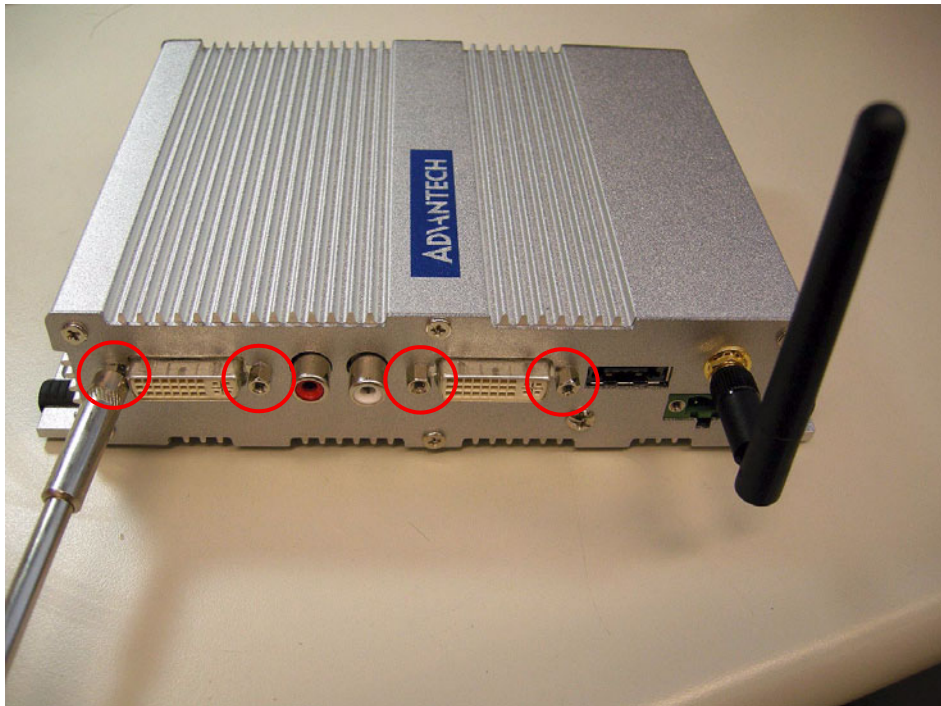

7. Unscrew the antenna mounting screw.

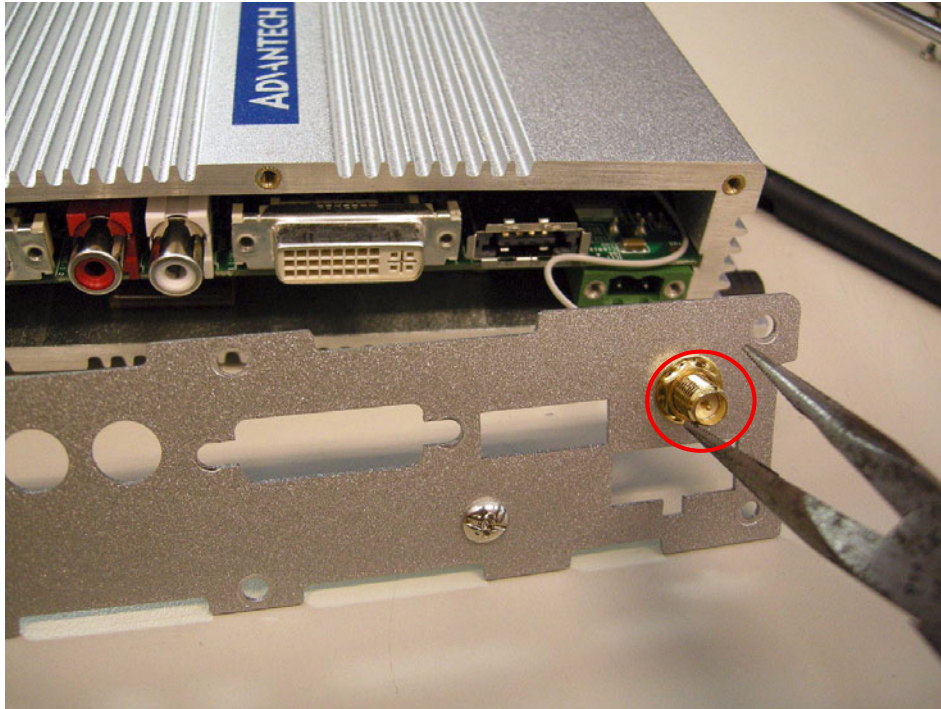

8. Pull out the carrier board from the Aluminum case on bottom side, and be careful with the thermal pad.

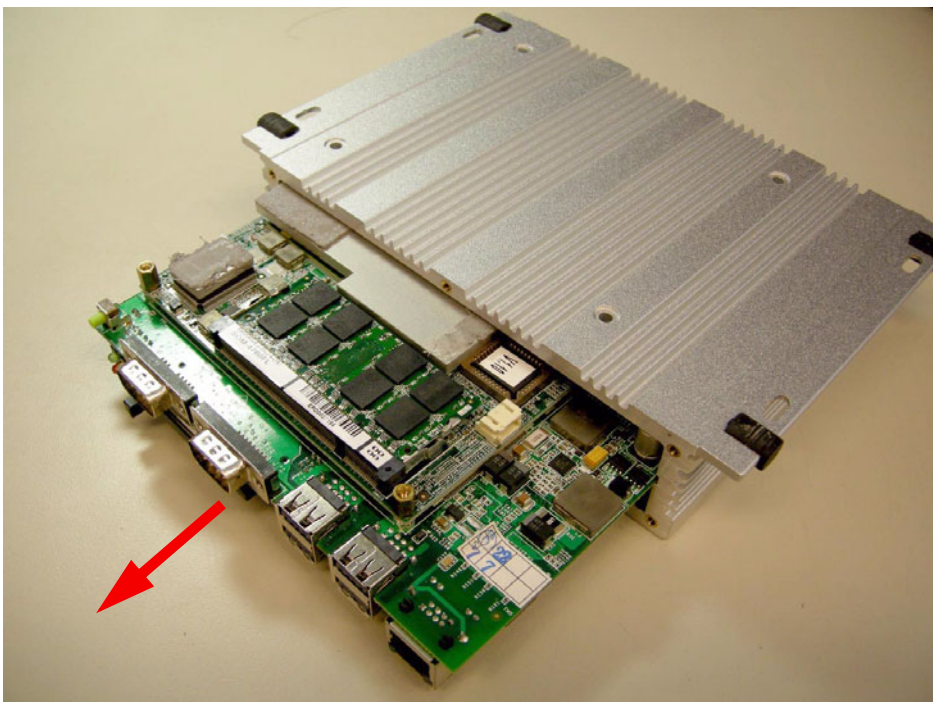

9. Memory socket.

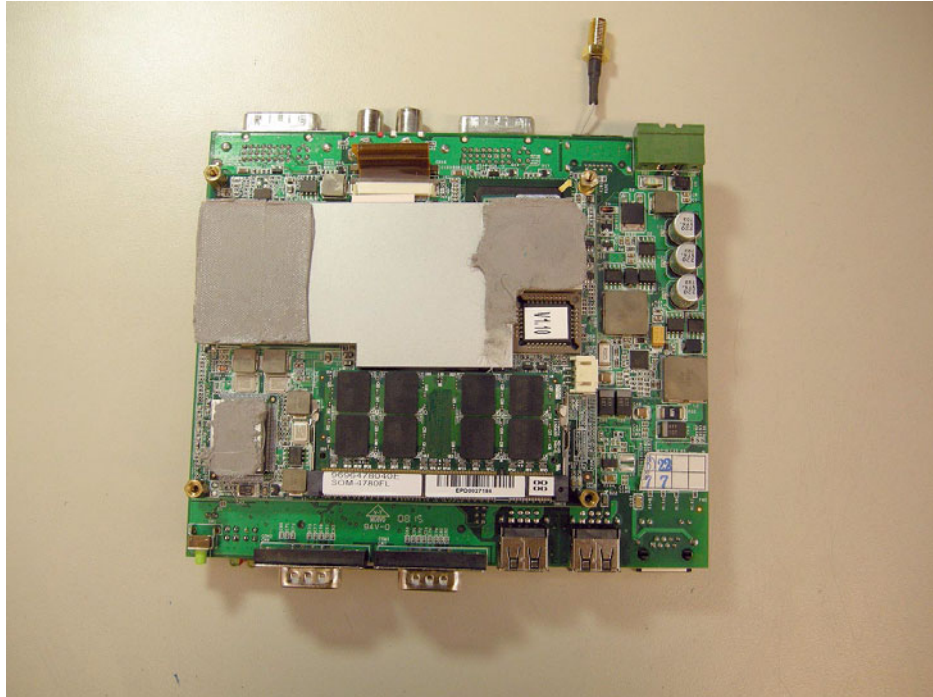

10. MiniPCI socket.

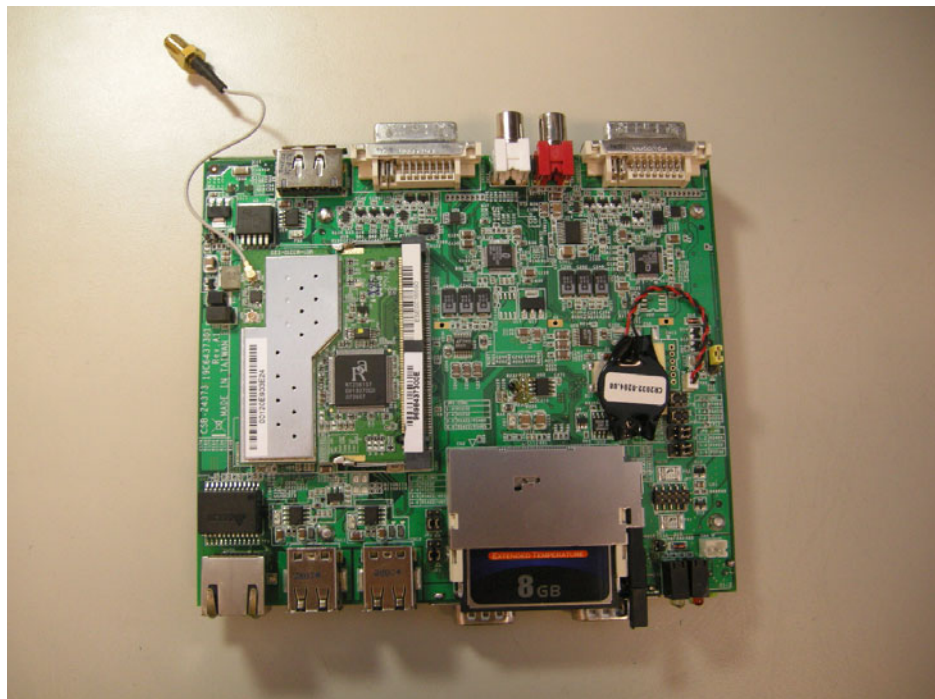

11. Jumper setting.

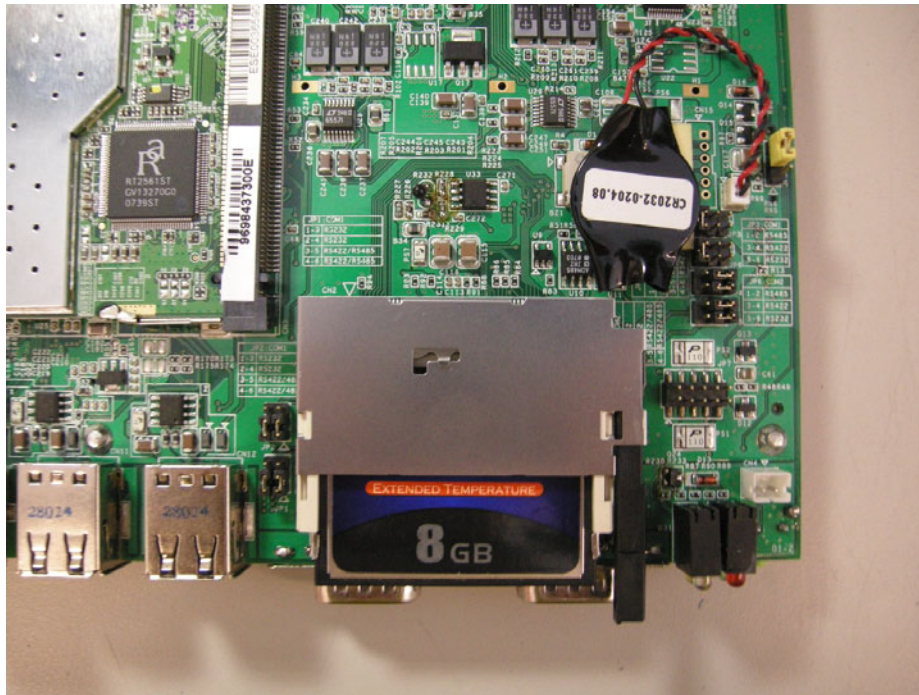

12. Install the board on the bottom side and be careful with the thermal pad.

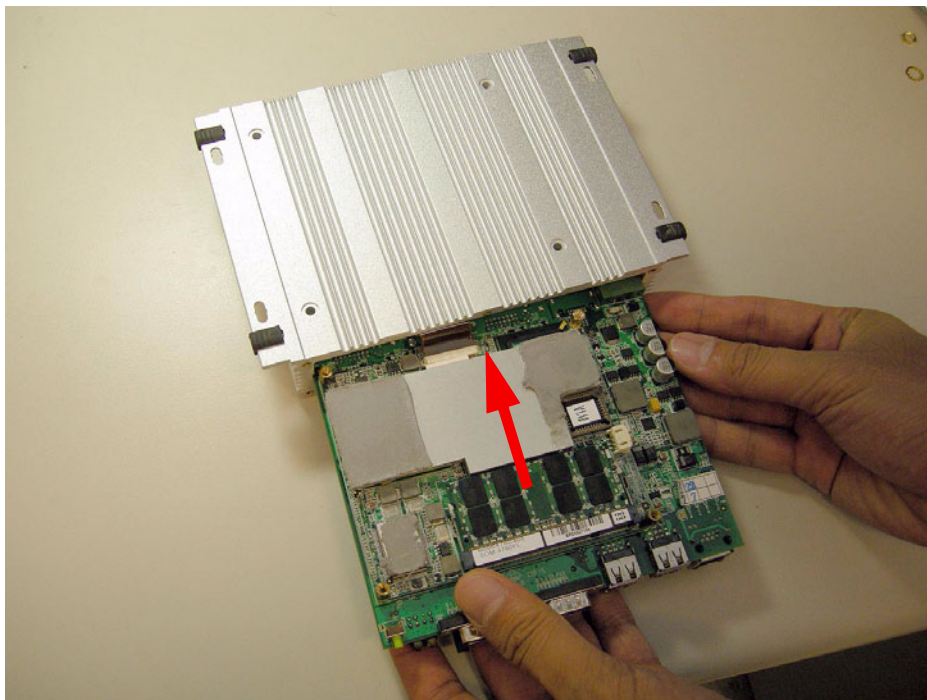

Appendix **A**

Realtek RTL8111B/
8111C Gigabit Boot
Agent Configuration
Menu

A.1 Realtek RTL8111B/8111C Gigabit Boot Agent Configuration Menu

This appendix allows the user to control the Boot Agent Setup Menu

1. When user need for the boot from LAN application, you can press the Shift + F10 to enter Boot Agent Setup Menu to setting during the system initialization.
2. The Intel Boot Agent Provide the two of Network Boot protocols (PXE and RPL), user can choose it on Network Boot Protocol item.

Trusted ePlatform Services

ADVANTECH

www.advantech.com

Please verify specifications before quoting. This guide is intended for reference purposes only.

All product specifications are subject to change without notice.

No part of this publication may be reproduced in any form or by any means, electronic, photocopying, recording or otherwise, without prior written permission of the publisher.

All brand and product names are trademarks or registered trademarks of their respective companies.

© Advantech Co., Ltd. 2008