



User Manual

AIMB-781

**LGA1155 Intel® Core™ i7/i5/i3/
Pentium ATX with DVI/VGA,
Dual Gigabit LAN, DDR3, SATA III**

Trusted ePlatform Services

ADVANTECH

Copyright

The documentation and the software included with this product are copyrighted 2011 by Advantech Co., Ltd. All rights are reserved. Advantech Co., Ltd. reserves the right to make improvements in the products described in this manual at any time without notice. No part of this manual may be reproduced, copied, translated or transmitted in any form or by any means without the prior written permission of Advantech Co., Ltd. Information provided in this manual is intended to be accurate and reliable. However, Advantech Co., Ltd. assumes no responsibility for its use, nor for any infringements of the rights of third parties, which may result from its use.

Acknowledgements

AMI is a trademark of American Megatrends Inc.

IBM and PC are trademarks of International Business Machines Corporation.

Intel® Core™ 2 Quad, Pentium® Dual Core and Celeron® are trademarks of Intel® Corporation.

WinBond is a trademark of Winbond Corporation.

All other product names or trademarks are properties of their respective owners.

A Message to the Customer

Advantech Customer Services

Each and every Advantech product is built to the most exacting specifications to ensure reliable performance in the harsh and demanding conditions typical of industrial environments. Whether your new Advantech equipment is destined for the laboratory or the factory floor, you can be assured that your product will provide the reliability and ease of operation for which the name Advantech has come to be known.

Your satisfaction is our primary concern. Here is a guide to Advantech's customer services. To ensure you get the full benefit of our services, please follow the instructions below carefully.

Technical Support

We want you to get the maximum performance from your products. So if you run into technical difficulties, we are here to help. For the most frequently asked questions, you can easily find answers in your product documentation. These answers are normally a lot more detailed than the ones we can give over the phone.

So please consult this manual first. If you still cannot find the answer, gather all the information or questions that apply to your problem, and with the product close at hand, call your dealer. Our dealers are well trained and ready to give you the support you need to get the most from your Advantech products. In fact, most problems reported are minor and are able to be easily solved over the phone.

In addition, free technical support is available from Advantech engineers every business day. We are always ready to give advice on application requirements or specific information on the installation and operation of any of our products.

Declaration of Conformity

FCC

This device complies with the requirements in part 15 of the FCC rules:

Operation is subject to the following two conditions:

- This device may not cause harmful interference
- This device must accept any interference received, including interference that may cause undesired operation.

This equipment has been tested and found to comply with the limits for a Class B digital device, pursuant to Part 15 of the FCC Rules. These limits are designed to provide reasonable protection against harmful interference when the equipment is operated in a commercial environment. This equipment generates, uses, and can radiate radio frequency energy and, if not installed and used in accordance with the instruction manual, may cause harmful interference to radio communications. Operation of this device in a residential area is likely to cause harmful interference in which case the user will be required to correct the interference at his/her own expense. The user is advised that any equipment changes or modifications not expressly approved by the party responsible for compliance would void the compliance to FCC regulations and therefore, the user's authority to operate the equipment.

Caution! *There is a danger of a new battery exploding if it is incorrectly installed. Do not attempt to recharge, force open, or heat the battery. Replace the battery only with the same or equivalent type recommended by the manufacturer. Discard used batteries according to the manufacturer's instructions.*



Memory Compatibility

Brand	Size	Speed	ECC	Vendor PN	Memory	Advantech PN
Transcend	1GB	DDR3 1066	N	TS128MLK64V1U/ TS2KNU28100-1S	SEC K4B1G0846D-HCF8 (128x8)	96D3-1G1066NN-TR
	1GB	DDR3 1066	N	TS128MLK64V1U	SEC K4B1G0846D HCH9 ENJ038A3 (128x8)	96D3-1G1066NN-TR
	2GB	DDR3 1066	N	TS256MLK64V1U/ TS5KNU28300-1S	SEC K4B1G0846D- HCF9(128x8)	96D3-2G1066NN-TR
Apacer	1GB	DDR3 1066	N	78.01GC3.420	ELPIDA J1108BDBG-DJ-F (128x8)	96D3-1G1066NN-AP
	2GB	DDR3 1066	N	78.A1GC3.421	ELPIDA J1108BDSE-DJ-F (128x8)	96D3-2G1066NN-AP
DSL	1GB	DDR3 1066	N	D3UE28081XH18AB	ELPIDA J1108BDSE-DJ-F (128x8)	NA
	2GB	DDR3 1066	N	D3UE28082XH18AB	ELPIDA J1108BDSE-DJ-F (128x8)	NA
Transcend	1GB	DDR3 1333	N	TS128MLK64V3U	ELPIDA J1108BDBG-DJ- F(128x8)	96D3-1G-1333NN- TR
	1GB	DDR3 1333	N	TS128MLK64V3U	Micron 9GF22 D9KPT (128x8)	NA
	2GB	DDR3 1333	N	TS256MLK64V3U	SEC 907 HCH9 K4B1G08460(128x8)	NA
Apacer	1GB	DDR3 1333	N	78.01GC6.420	ELPIDA J1108BFBG-DJ- F(128x8)	96D3-1G1333NN-AP
	2GB	DDR3 1333	N	78.A1GC6.421	ELPIDA J1108BDBG-DJ-F (128x8)	96D3-2G1333NN-AP
	2GB	DDR3 1333	N	78.A1GDE.AF00C	Hynix H5TQ2G838FR(256x8)	96D3-2G1333NN- AP1
	4GB	DDR3 1333	N	78.B1GDE.AF1	Hynix H5TQ2G83AFR H9C(256x8)	NA
DSL	1GB	DDR3 1333	N	D3UE28081XH18AB	ELPIDA J1108BDSE-DJ-F (128x8)	NA
	2GB	DDR3 1333	N	D3UE28082XH18AB	ELPIDA J1108BDSE-DJ-F (128x8)	NA
Kingston	1GB	DDR3 1333	N	KVR1333D3N9/1G	HYNIX H5TQ1G83BFR H9C 928AK (128x8)	NA
	2GB	DDR3 1333	N	TS128MLK64V3U	ELPIDA J1108BDBG-DJ-F 093309DLK20 (256x8)	NA
ATP	4GB	DDR3-1333	N	AQ12M64B8BKH9S	SAMSUNG 949 K4B2G0846B-HCH9 (256x8)	NA

AIMB-781 Feature Comparison

	AIMB-781QG2	AIMB-781QVG
Chipset	Q67	B65
Memory	Non-ECC DDR3 1066/1333	Non-ECC DDR3 1066/1333
USB	14	12
GbE	2	1
COM	6	2
SW RAID	Yes	None
TPM	Optional	Optional
SATA III	2	1
Active Management Technology 7.0	Yes	None

Product Warranty (2 years)

Advantech warrants to you, the original purchaser, that each of its products will be free from defects in materials and workmanship for two years from the date of purchase.

This warranty does not apply to any products which have been repaired or altered by persons other than repair personnel authorized by Advantech, or which have been subject to misuse, abuse, accident or improper installation. Advantech assumes no liability under the terms of this warranty as a consequence of such events.

Because of Advantech's high quality-control standards and rigorous testing, most of our customers never need to use our repair service. If an Advantech product is defective, it will be repaired or replaced at no charge during the warranty period. For out-of-warranty repairs, you will be billed according to the cost of replacement materials, service time and freight. Please consult your dealer for more details.

If you think you have a defective product, follow these steps:

1. Collect all the information about the problem encountered. (For example, CPU speed, Advantech products used, other hardware and software used, etc.) Note anything abnormal and list any onscreen messages you get when the problem occurs.
2. Call your dealer and describe the problem. Please have your manual, product, and any helpful information readily available.
3. If your product is diagnosed as defective, obtain an RMA (return merchandise authorization) number from your dealer. This allows us to process your return more quickly.
4. Carefully pack the defective product, a fully-completed Repair and Replacement Order Card and a photocopy proof of purchase date (such as your sales receipt) in a shippable container. A product returned without proof of the purchase date is not eligible for warranty service.
5. Write the RMA number visibly on the outside of the package and ship it prepaid to your dealer.

Initial Inspection

Before you begin installing your motherboard, please make sure that the following materials have been shipped:

- 1 AIMB-781 Startup Manual
- 1 Driver CD (user's manual is included)
- 2 Serial ATA HDD data cables
- 2 Serial ATA HDD power cables
- 1 I/O port bracket
- 1 Warranty card

If any of these items are missing or damaged, contact your distributor or sales representative immediately. We have carefully inspected the AIMB-781 mechanically and electrically before shipment. It should be free of marks and scratches and in perfect working order upon receipt. As you unpack the AIMB-781, check it for signs of shipping damage. (For example, damaged box, scratches, dents, etc.) If it is damaged or it fails to meet the specifications, notify our service department or your local sales representative immediately. Also notify the carrier. Retain the shipping carton and packing material for inspection by the carrier. After inspection, we will make arrangements to repair or replace the unit.

Contents

Chapter 1 Hardware Configuration1

1.1	Introduction	2
1.2	Features	2
1.3	Specifications	3
1.3.1	System	3
1.3.2	Memory	3
1.3.3	Input/Output	3
1.3.4	Graphics.....	3
1.3.5	Ethernet LAN	4
1.3.6	Industrial Features	4
1.3.7	Mechanical and Environmental Specifications.....	4
1.4	Jumpers and Connectors	5
	Table 1.1: Jumper list	5
	Table 1.2: Connectors	5
1.5	Board Layout: Jumper and Connector Locations.....	7
	Figure 1.1 Jumper and Connector Locations.....	7
	Figure 1.2 I/O connectors	7
1.6	AIMB-781 Block Diagram.....	8
	Figure 1.3 AIMB-781 Block Diagram	8
1.7	Safety Precautions	8
1.8	Jumper Settings	9
1.8.1	How to set jumpers	9
1.8.2	CMOS clear (JCMOS1)	9
	Table 1.3: JCMOS1	9
1.8.3	Watchdog timer output (JWDT1)	10
	Table 1.4: Watchdog timer output (JWDT1)	10
	Table 1.5: ATX/AT mode selector (PSON1).....	10
	Table 1.6: COM3 RS-232/422/485 mode selector (JSETCOM3)..	10
1.9	System Memory	11
1.10	Memory Installation Procedures.....	11
1.11	Cache Memory.....	11
1.12	Processor Installation.....	11
1.13	PCI Bus Routing Table.....	11

Chapter 2 Connecting Peripherals13

2.1	Introduction	14
2.2	Parallel Port (LPT1).....	14
2.3	USB Ports (LAN1_USB12, LAN2_USB3/4, USB5/6, USB7/8, USB9/10, USB11/12 & USB13/14).....	15
2.4	USB Power Switch	16
2.5	VGA Connector and DVI-D Connector (VGA1+DVI1).....	17
2.6	Serial Ports (COM1, COM2, COM3, COM4, COM5 & COM6)	18
2.7	PS/2 Keyboard and Mouse Connector (KBMS1)	19
2.8	External Keyboard & Mouse (KBMS2).....	20
2.9	CPU Fan Connector (CPUFAN1).....	20
2.10	System FAN Connector (SYSFAN1 and SYSFAN2)	21
2.11	Front Panel Connectors (JFP1, JFP2 & JFP3)	21
2.11.1	Power LED and Keyboard Lock (JFP3)	22
	Table 2.1: PS/2 or ATX power supply LED status.....	22
2.11.2	External Speaker (JFP2 pins 1, 4, 7 & 10).....	22
2.11.3	HDD LED Connector (JFP2 pins 2 & 5).....	22
2.11.4	SNMP SM_Bus connector (JFP2 pins 8 & 11)	22

2.11.5	ATX Soft Power Switch (JFP1 pins 3 & 6)	22
2.11.6	Reset Connector (JFP1 pins 9 & 12)	22
2.12	Line Out, Mic In Connector (AUDIO1)	23
2.13	8-pin Alarm Board Connector (VOLT1).....	23
2.14	Case Open Connector (JCASE1)	24
2.15	Front Panel LAN Indicator Connector (LAN_LED1).....	25
	Table 2.2: Front Panel LAN Indicator Connector	25
2.16	Serial ATA Interface (SATA1, SATA2, SATA3, SATA4, SATA5 & SATA6) 26	
2.17	PCI Slots (PCI 1 ~ PCI 4).....	27
2.18	PCIe x16 Expansion Slot (PCIEX16_1)	27
2.19	PCIEX4_1	28
2.20	PCIEX1_1	28
2.21	Auxiliary 4-pin power connector (ATX12V1)	29
2.22	SPI Flash connector(SPI_CN1)	29
2.23	Low Pin Count Connector (LPC1).....	30
	Table 2.3: Advantech LPC Module List	30

Chapter 3 BIOS Operation 31

3.1	Introduction	32
	Figure 3.1 Main setup screen	32
3.2	Entering BIOS Setup.....	32
3.2.1	Main Menu	33
	Figure 3.2 Main setup screen	33
3.2.2	System time / System date	33
3.3	Advanced BIOS Features Setup.....	34
	Figure 3.3 Advanced BIOS features setup screen	34
3.3.1	ACPI Settings	35
	Figure 3.4 ACPI Settings	35
3.3.2	Trusted Computing	36
	Figure 3.5 TPM Settings	36
3.3.3	CPU Configuration.....	37
	Figure 3.6 CPU Configuration	37
	Figure 3.7 CPU Information.....	37
3.3.4	SATA Configuration.....	39
	Figure 3.8 SATA Configuration.....	39
3.3.5	Intel IGD SWSCI OpRegion Configuration	40
	Figure 3.9 Intel IGD SWSCI OpRegion Configuration	40
3.3.6	Intel TXT(LT) Configuration	41
	Figure 3.10 Intel Trusted Execution Technology Configuration... 41	
3.3.7	USB Configuration	42
	Figure 3.11 USB Configuration.....	42
3.3.8	NCT6776 Super IO Configuration.....	43
	Figure 3.12 Super IO Configuration.....	43
	Figure 3.13 Serial Port 1 Configuration	43
	Figure 3.14 Serial Port 2 Configuration	44
	Figure 3.15 Parallel Configuration	44
3.3.9	H/W Monitor.....	45
	Figure 3.16 PC Health Status	45
3.3.10	F81216 Super IO Configuration.....	46
	Figure 3.17 F81216 Super IO Configuration	46
	Figure 3.18 Serial Port 3 Configuration	47
	Figure 3.19 Serial Port 4 Configuration	48
	Figure 3.20 Serial Port 5 Configuration	48
	Figure 3.21 Serial Port 6 Configuration	49
3.3.11	AMT Configuration.....	50
	Figure 3.22 AMT Configuration	50
3.3.12	Serial Port Console Redirection.....	51

	Figure 3.23Serial Port Console Redirection	51
3.4	Chipset	53
	Figure 3.24Chipset	53
3.4.1	North Bridge.....	54
	Figure 3.25North Bridge	54
3.4.2	South Bridge	55
	Figure 3.26South Bridge.....	55
3.4.3	USB Configuration	56
	Figure 3.27USB Configuration.....	56
3.4.4	ME Subsystem.....	57
	Figure 3.28ME Subsystem	57
3.5	Boot.....	58
	Figure 3.29Boot	58
3.6	Security	59
	Figure 3.30Security.....	59
3.7	Save & Exit.....	60
	Figure 3.31Save & Exit.....	60

Chapter 4 Chipset Software Installation Utility 61

4.1	Before you begin	62
4.2	Introduction	62
4.3	Windows XP / Windows 7 Driver Setup	63

Chapter 5 VGA Setup.....65

5.1	Introduction	66
5.2	Windows XP/Windows 7 Driver Setup	66

Chapter 6 LAN Configuration.....67

6.1	Introduction	68
6.2	Features	68
6.3	Installation	68
6.4	Win XP /Win 7 Driver Setup (LAN).....	68

Appendix A Programming the Watchdog Timer ..69

A.1	Watchdog timer overview	70
A.2	Programming the Watchdog Timer	70
	Table A.1: Watchdog timer registers.....	72
A.2.1	Example Programs	72

Appendix B I/O Pin Assignments.....77

B.1	Parallel Port (LPT1).....	78
	Table B.1: Parallel Port (LPT1)	78
B.2	USB Header (USB56, USB78, USB910, USB1112 & USB1314)	78
	Table B.2: USB Header (USB56,USB78,USB910,USB1112,USB1314)78	
B.3	VGA Connector (VGA1)	79
	Table B.3: VGA Connector (VGA1)	79
B.4	RS-232 Interface (COM3~6)	79
	Table B.4: RS-232 Interface (COM1).....	79
B.5	PS/2 Keyboard and Mouse Connector (KBMS1)	80
	Table B.5: Keyboard and Mouse Connector (KBMS1)	80

B.6	External Keyboard Connector (KBMS2)	80
	Table B.6: External Keyboard Connector (KBMS2).....	80
B.7	Infrared (IR) connector (JIR1)	81
	Table B.7: Infrared Connector (JIR1).....	81
B.8	System Fan Power Connector (SYSFAN1/SYSFAN2).....	81
	Table B.8: Fan Power Connector (SYSFAN1/SYSFAN2)	81
B.9	Power LED and Keyboard Lock (JFP3)	81
	Table B.9: Power LED and Keyboard Lock (JFP3)	81
B.10	External Speaker Connector (JFP2)	82
	Table B.10:External Speaker Connector (JFP2)	82
B.11	Reset Connector (JFP1)	82
	Table B.11:Reset Connector (JFP1).....	82
B.12	HDD LED Connector (JFP2).....	82
	Table B.12:HDD LED Connector (JFP2)	82
B.13	ATX Soft Power Switch (JFP1)	82
	Table B.13:ATX Soft Power Switch (JFP1)	83
B.14	H/W Monitor Alarm (JOBS1).....	83
	Table B.14:H/W Monitor Alarm (JOBS1)	83
B.15	SNMP SM_BUS Bus Connector (JFP2)	83
	Table B.15:SM Bus Connector (JFP2)	83
B.16	USB/LAN ports (LAN1_USB12 and LAN2_USB34)	84
	Table B.16:USB Port	84
	Table B.17:Giga LAN 10/100/1000 Base-T RJ-45 port	84
B.17	Line Out, Mic IN Connector (AUDIO1).....	84
B.18	Front Panel Audio Connector (FPAUD1)	85
	Table B.18:Front Panel Audio Connector (FPAUD1)	85
B.19	8-pin Alarm Board Connector (VOLT1).....	85
	Table B.19:8-pin Alarm Board Connector (VOLT1)	85
B.20	Case Open Connector (JCASE1)	86
	Table B.20:Case Open Connector (JCASE1).....	86
B.21	Front Panel LAN LED Connector (LAN_LED1)	86
	Table B.21:LAN LED Connector (LANLED1)	86
B.22	SPI_CN1: SPI flash card pin connector	86
	Table B.22:SPI_CN1:SPI fresh card pin connector	86
B.23	System I/O Ports.....	87
	Table B.23:System I/O ports.....	87
B.24	DMA Channel Assignments	87
	Table B.24:DMA channel assignments.....	87
B.25	Interrupt Assignments	88
	Table B.25:Interrupt assignments.....	88
B.26	1st MB Memory Map	88
	Table B.26:1st MB memory map	88

Chapter 1

Hardware
Configuration

1.1 Introduction

AIMB-781 motherboard is the most advanced Intel Q67/B65 board for industrial applications that require high-performance computing. The motherboard supports 2nd generation Intel Core i7/i5/i3/Pentium and DDR3 1066/1333 MHz memory up to 16 GB. AIMB-781 provides cost-effective graphics integrated in processor which is Intel HD 2000/3000 graphics, and the graphics VRAM is 1 GB maximum shared memory with 2 GB and above system memory installed.

AIMB-781 provides a mainstream PCIe x16 gen II expansion slot for add-on graphic cards to meet higher graphics performance demand. In addition, the AIMB-781 has dual Gigabit Ethernet LAN (QG2 version) via dedicated PCIe x1 bus, which offers bandwidth of up to 500 MB/s, eliminating network bottlenecks. High reliability and outstanding performance make the AIMB-781 the ideal platform for industrial networking applications.

By using the Intel Q67/B65 chipset, the AIMB-781 offers four 32-bit, 33 MHz PCI slots; one PCIe x1 slot, one PCIe x4 slot, one PCIe x16 slot and a variety of features such as 2 onboard SATA III interfaces (bandwidth = 600 MB/s) and 4 onboard SATA II with software RAID; 14 USB 2.0 connectors and HD Audio. These powerful I/O capabilities ensure even more reliable data storage capabilities and high-speed I/O peripheral connectivity.

The AIMB-781 also adopts Advantech's unique patented Sleep Mode Control Circuit for AT Power Mode. With all the excellent features and outstanding performance, the AIMB-781 is the ideal platform for today's industrial applications.

1.2 Features

- **PCIe architecture:** The Intel Q67/B65 PCH chipset supports 1 PCIe x16 slot, 1 PCIe x4 slot, 1 PCIe x1 slot, 2 SATA III and 4 SATA II connectors (QG2 version).
- **High Performance I/O capability:** Dual Gigabit LAN via PCIe x1 bus, 4 PCI 32-bit/33MHz PCI slots, and 14 USB 2.0 ports (QG2 version).
- **Standard ATX form factor with industrial features:** AIMB-781 provides industrial features like long product life, reliable operation under wide temperature range, watchdog timer functions, etc.
- **Automatically power on after power failure:** It is often necessary to have an unattended system come back to operation when power resumes after a power failure. Advantech's industrial motherboard allows users to set the system to power on automatically without pushing the power on button. Please refer detail "AT" mode setting in table 1.5 of section 1.8.3.
- **Active Management Technology 7.0:** The hardware and firmware base solution is powered by the system auxiliary power plane to remotely monitor networked systems. Intel AMT(iAMT) stores hardware and software information in nonvolatile memory. Built-in management provides out-of-band management capabilities, allowing remote discovery and KVM to repair systems after OS failures or when a system is crashed. Alert and event logging features detect problems and quickly reduce downtime, pro-actively blocking incoming threats, containing infected clients before they impact the network, and proactively notifying the user when critical software agents are removed. For iAMT enable, please refer 3.3.8 AMT Configuration. Advantech provides Software utility called SUSIAccess to allow user enabling iAMT function. For detail information and user manual, please download it from link:
<http://www.advantech.com.tw/embcore/SUSIAccess.aspx>

1.3 Specifications

1.3.1 System

- **SATA hard disk drive interface:** Six on-board SATA III/II connectors support Advanced Host controller interface (AHCI) technology and have data transmission rates up to 600 MB/s or 300 MB/s.
- **System Chipset:** Q67 for QG2 SKU and B65 for QVG SKU

1.3.2 Memory

- **RAM:** Up to 16 GB in four 240-pin DIMM sockets. Supports dual-channel DDR3 1066/1333 SDRAM.
 - AIMB-781QG2/QVG: supports non-ECC unbuffered DIMMs and do not support any memory configuration that mixes non-ECC with ECC unbuffered DIMMs

Note! A 32-bit OS may not fully detect 4 GB of RAM when 4 GB is installed.



1.3.3 Input/Output

- **PCIe slot:** 1 PCIe x16 expansion slot, 1 PCIe x4 expansion slot, and 1 PCIe x1 expansion slot
- **PCI Bus:** 4 PCI slots, 32-bit, 33 MHz PCI 2.2 compliant
- **Enhanced parallel port:** Configured to LPT1 or disabled. Standard DB-25 female connector cable is an optional accessory. LPT1 supports EPP/SPP/ECP.
- **Serial port:** Six serial ports, one is RS-232/422/485 with hardware auto-flow control and three are RS-232. Two DB-9 connectors located in rear panel are RS-232
- **Keyboard and PS/2 mouse connector:** Two 6-pin mini-DIN connectors are located on the mounting bracket for easy connection to PS/2 keyboard and mouse.
- **USB port:** Supports up to 14 USB 2.0 ports for QG2 and 12 USB 2.0 ports for QVG with transmission rates up to 480 Mbps
- **LPC:** One LPC connector to support Advantech LPC modules, such as TPM module, RS232 module, and RS422/485 module.
- **GPIO:** AIMB-781 supports 8-bit GPIO from super I/O for general purpose control application.

1.3.4 Graphics

- *Both dual and quad core processors are integrated Intel HD Graphics 2000/3000.*
- **Display memory:** 1 GB maximum shared memory with 2 GB and above system memory installed
- **DVI-D:** Up to resolution 1920 x 1200 @ 60 Hz refresh rate (Only for QG2 version)
- **CRT:** Up to 2048 x 1536 resolution @ 75 Hz refresh rate

1.3.5 Ethernet LAN

- Supports single/dual 10/100/1000Base-T Ethernet port (s) via PCIe x1 bus which provides a 500 MB/s data transmission rate.
- **Interface:** 10/100/1000Base-T
- **Controller:** Intel 82579LM(PHY) for LAN1, Intel 82583V for LAN2 (QG2 version only)

1.3.6 Industrial Features

- **Watchdog timer:** Can generate system reset or NC. The watchdog timer is programmable, with each unit equal to one second or one minute (255 levels)

1.3.7 Mechanical and Environmental Specifications

- **Operating temperature:** 0 ~ 60°C (32 ~ 140° F, Depending on CPU)
- **Storage temperature:** -20 ~ 70° C (-4 ~ 158° F)
- **Humidity:** 5 ~ 95% non-condensing
- **Power supply voltage:** +3.3 V, +5 V, ±12 V, 5 VSB
- **Power consumption:**
Maximum: +5 V at 2.89 A, +3.3 V at 1.02 A, +12 V at 5.88 A, +5 VSB at 0.5 A (Intel i5 2400 3.1 GHz processor, 4 x 4 GB DDR3 Memory)
- **Board size:** 304.8 x 228.6 mm (12" x 9.6")
- **Board weight:** 0.5 kg (1.68 lb)

1.4 Jumpers and Connectors

Connectors on the AIMB-781 motherboard link it to external devices such as hard disk drives and a keyboard. In addition, the board has a number of jumpers that are used to configure your system for your application.

The tables below list the function of each of the jumpers and connectors. Later sections in this chapter give instructions on setting jumpers. Chapter 2 gives instructions for connecting external devices to your motherboard.

Table 1.1: Jumper list

Label	Function
JCMOS1	CMOS Clear
JWDT1	Watchdog reset
PSON1	AT(1-2) / ATX(2-3)
JSETCOM3	COM3 RS-232/422/485 Jumper Setting

Table 1.2: Connectors

Label	Function
LPT1	Parallel port, supports SPP/EPP/ECP mode
LAN1_USB12	LAN1 / USB port 1, 2
LAN2_USB34	LAN2 / USB port 3, 4
VGA1	VGA connector
DVI1	DVI-D connector
COM 1~2 and 4~6	Serial port: RS-232
COM3	Serial port: RS-232/422/485 (9-pin connector)
KBMS1	PS/2 keyboard and mouse connector
KBMS2	External keyboard connector (6-pin)
JIR1	Infrared connector
JFP3	Keyboard lock and power LED
	Suspend: fast flash (ATX/AT)
	System On: on (ATX/AT)
	System Off: off (AT)
JFP2	External speaker / HDD LED connector / SM Bus connector
JFP1	Power switch / reset connector
JCASE1	Case open
VOLT1	Voltage display
JOBS1	HW monitor
	Close: enable OBS alarm Open: disable OBS alarm
CPUFAN1	CPU fan connector (4-pin)
SYSFAN1	System fan connector (3-pin)
SYSFAN2	System fan connector (3-pin)
LANLED1	LAN1/2 LED extension connector
AUDIO1	Audio connector
FPAUO1	HD audio front panel pin header
USB56	USB port 5, 6

Table 1.2: Connectors

Label	Function
USB78	USB port 7, 8 (OG2 version only)
USB910	USB port 9, 10
USB1112	USB port 11,12
USB1314	USB port 13,14
SATA1	Serial ATA1
SATA2	Serial ATA2
SATA3	Serial ATA3
SATA4	Serial ATA4
SATA5	Serial ATA5
SATA6	Serial ATA6
ATX12V1	ATX 12 V auxiliary power connector (for CPU)
EATXPWR1	ATX 24-pin main power connector (for system)
PCIEX16_1	PCIe x16 slot 1
PCIEX4_1	PCIe x4 slot 1
PCIEX1_1	PCIe x1 slot 1
PCI1	PCI slot 1
PCI2	PCI slot 2
PCI3	PCI slot 3
PCI4	PCI slot 4
DIMMA1	Channel A DIMM1
DIMMA2	Channel A DIMM2
DIMMB1	Channel B DIMM1
DIMMB2	Channel B DIMM2
SPI_CN1	Update BIOS pin header
SPDIF_OUT1	SPDIF Audio out pin header
JEME1	Intel AMT Disable Jumper
JMECLR1	Clear AMT setting
JUSBPWR1	USB port 1~4 power source switch between +5 VSB and +5 V
JUSBPWR2	USB port 5/6/7/8/11/12 power source switch between +5 VSB and +5 V
JUSBPWR3	USB port 9/10/13/14 power source switch between +5 VSB and +5 V
GPIO1	8 bit GPIO from super I/O
SMBUS1	SM Bus from PCH

1.5 Board Layout: Jumper and Connector Locations

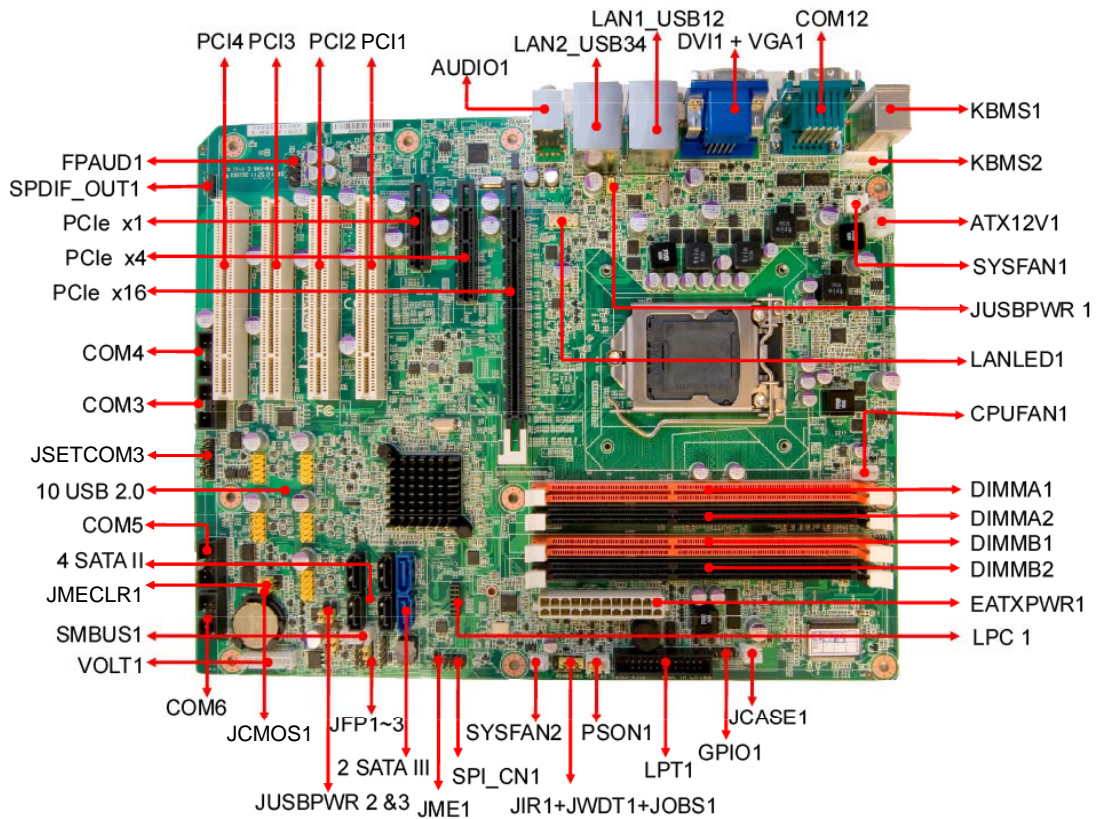

Figure 1.1 Jumper and Connector Locations



AIMB-781QG2-00A1E



AIMB-781QVG-00A1E

Figure 1.2 I/O connectors

1.6 AIMB-781 Block Diagram

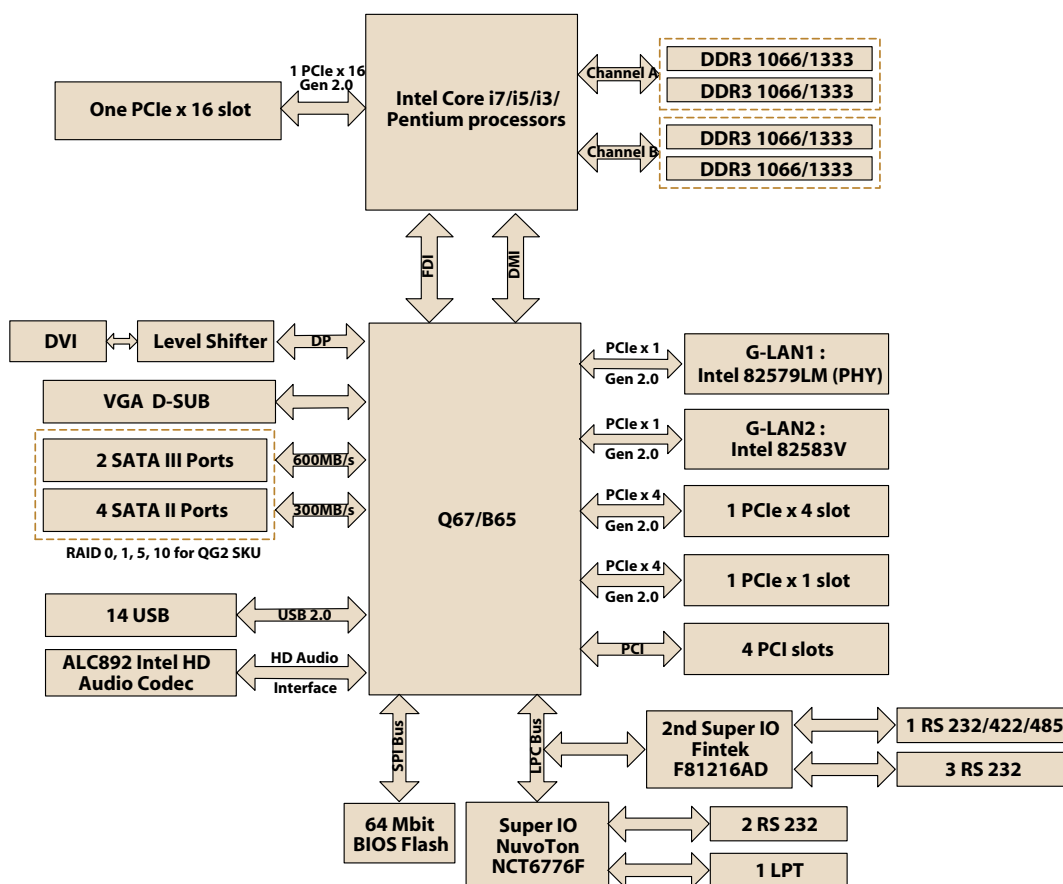

Figure 1.3 AIMB-781 Block Diagram

1.7 Safety Precautions

Warning! Always completely disconnect the power cord from your chassis whenever you work with the hardware. Do not make connections while the power is on. Sensitive electronic components can be damaged by sudden power surges. Only experienced electronics personnel should open the PC chassis.



Caution! Always ground yourself to remove any static charge before touching the motherboard. Modern electronic devices are very sensitive to static electric discharges. As a safety precaution, use a grounding wrist strap at all times. Place all electronic components on a static-dissipative surface or in a static-shielded bag when they are not in the chassis.



Caution! *The computer is provided with a battery-powered Real-time Clock circuit. There is a danger of explosion if battery is incorrectly replaced. Replace only with same or equivalent type recommended by the manufacturer. Discard used batteries according to manufacturer's instructions.*



Caution! *There is a danger of a new battery exploding if it is incorrectly installed. Do not attempt to recharge, force open, or heat the battery. Replace the battery only with the same or equivalent type recommended by the manufacturer. Discard used batteries according to the manufacturer's instructions.*



1.8 Jumper Settings

This section provides instructions on how to configure your motherboard by setting the jumpers. It also includes the motherboard default settings and your options for each jumper.

1.8.1 How to set jumpers

You can configure your motherboard to match the needs of your application by setting the jumpers. A jumper is a metal bridge that closes an electrical circuit. It consists of two metal pins and a small metal clip (often protected by a plastic cover) that slides over the pins to connect them. To “close” (or turn on) a jumper, you connect the pins with the clip. To “open” (or turn off) a jumper, you remove the clip. Sometimes a jumper consists of a set of three pins, labeled 1, 2, and 3. In this case you connect either pins 1 and 2, or 2 and 3. A pair of needle-nose pliers may be useful when setting jumpers.

1.8.2 CMOS clear (JCMOS1)

The AIMB-781 motherboard contains a jumper that can erase CMOS data and reset the system BIOS information. Normally this jumper should be set with pins 1-2 closed. If you want to reset the CMOS data, set J1 to 2-3 closed for just a few seconds, and then move the jumper back to 1-2 closed. This procedure will reset the CMOS to its default setting.

Table 1.3: JCMOS1

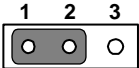
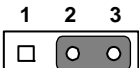
Function	Jumper Setting
* Keep CMOS and ME data	 1-2 closed
Clear CMOS and ME data	 2-3 closed
* default setting	

1.8.3 Watchdog timer output (JWDT1)

The AIMB-781 contains a watchdog timer that will reset the CPU. This feature means the AIMB-781 will recover from a software failure or an EMI problem. The JWDT1 jumper settings control the outcome of what the computer will do in the event the watchdog timer is tripped.

Table 1.4: Watchdog timer output (JWDT1)

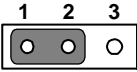
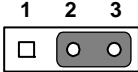
Function	Jumper Setting
NC	 1-2 closed
* Reset	 2-3 closed
* default setting	

Note! *The interrupt output of the watchdog timer is a low level signal. It will be held low until the watchdog timer is reset.*



Table 1.5: ATX/AT mode selector (PSON1)

Function	Jumper Setting
AT Mode	 1-2 closed
* ATX Mode	 2-3 closed
* default setting	

Table 1.6: COM3 RS-232/422/485 mode selector (JSETCOM3)

Use JSETCOM3 to select the RS-232/422/485 mode for COM3. The default setting is RS-232.

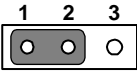
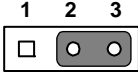
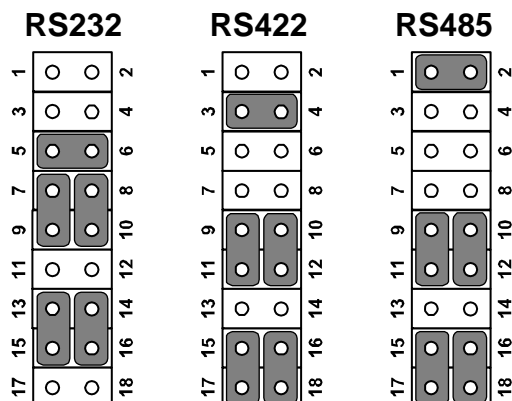

1.9 System Memory

AIMB-781 has four 240-pin memory sockets for DDR3 1066/1333 MHz memory modules with maximum capacity of 16GB (Maximum 4GB for each DIMM). AIMB-781QG2 and AIMB-781QVG SKU only support non-ECC DDR3 memory modules. Please note that both versions AIMB-781 do NOT support registered DIMMs (RDIMMs).

Note! *Because AIMB-781 supports Intel Active Management Technology 7.0 (iAMT7.0) which utilizes some memory space of channel 0, it's suggested that the user should not leave channel 0 DIMM slots (DIMMA1 and DIMMA2) empty, or it may cause some system abnormality.*



1.10 Memory Installation Procedures

To install DIMMs, first make sure the two handles of the DIMM socket are in the “open” position. i.e. The handles lean outward. Slowly slide the DIMM module along the plastic guides on both ends of the socket, and then press the DIMM module right down into the socket, until you hear a click. This is when the two handles have automatically locked the memory module into the correct position of the DIMM socket. To remove the memory module, just push both handles outward, and the memory module will be ejected by the mechanism in the socket.

1.11 Cache Memory

The AIMB-781 supports a CPU with one of the following built-in full speed L3 caches: The built-in third-level cache in the processor yields much higher performance than conventional external cache memories.

- 8 MB for 2nd Generation Intel Core i7-2xxx CPU
- 6 MB for 2nd Generation Intel Core i5-2xxx CPU
- 3 MB for 2nd Generation Intel Core i3-2xxx CPU
- 3 MB for Intel Pentium CPU

1.12 Processor Installation

The AIMB-781 is designed for LGA1155, Intel Core i7/i5/i3/Pentium processor.

1.13 PCI Bus Routing Table

AD PCI slot INT	PCI1	PCI2	PCI3	PCI4
	AD16	AD21	AD22	AD28
A	A	F	G	H
B	B	G	H	E
C	C	H	E	F
D	D	E	F	G

Chapter 2

Connecting
Peripherals

2.1 Introduction

You can access most of the connectors from the top of the board as it is being installed in the chassis. If you have a number of cards installed, you may need to partially remove a card to make all the connections.

2.2 Parallel Port (LPT1)

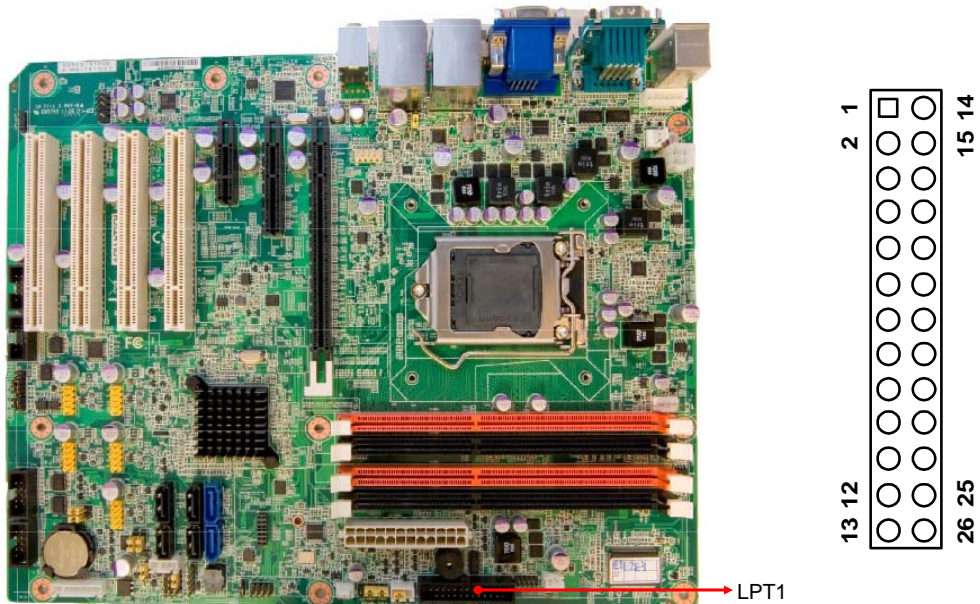

The parallel port is normally used to connect the motherboard to a printer. The AIMB-781 includes an onboard parallel port, accessed through a 25-pin flat-cable connector, LPT1.

2.3 USB Ports (LAN1_USB12, LAN2_USB3/4, USB5/6, USB7/8, USB9/10, USB11/12 & USB13/14)

These ports support Plug & Play and hot swapping for up to 127 external devices. The USB ports comply with USB specification rev. 2.0. Transmission rates of up to 480 Mbps and fuse protection are supported. The USB interface can be disabled in the system BIOS setup.

The AIMB-781 is equipped with one or two high-performance 1000 Mbps Ethernet LANs. They are supported by all major network operating systems. The RJ-45 jacks on the rear plate provide convenient 1000Base-T operation.

If all USB ports will be used, USB power is recommended to switch to +5V instead of +5VSB.

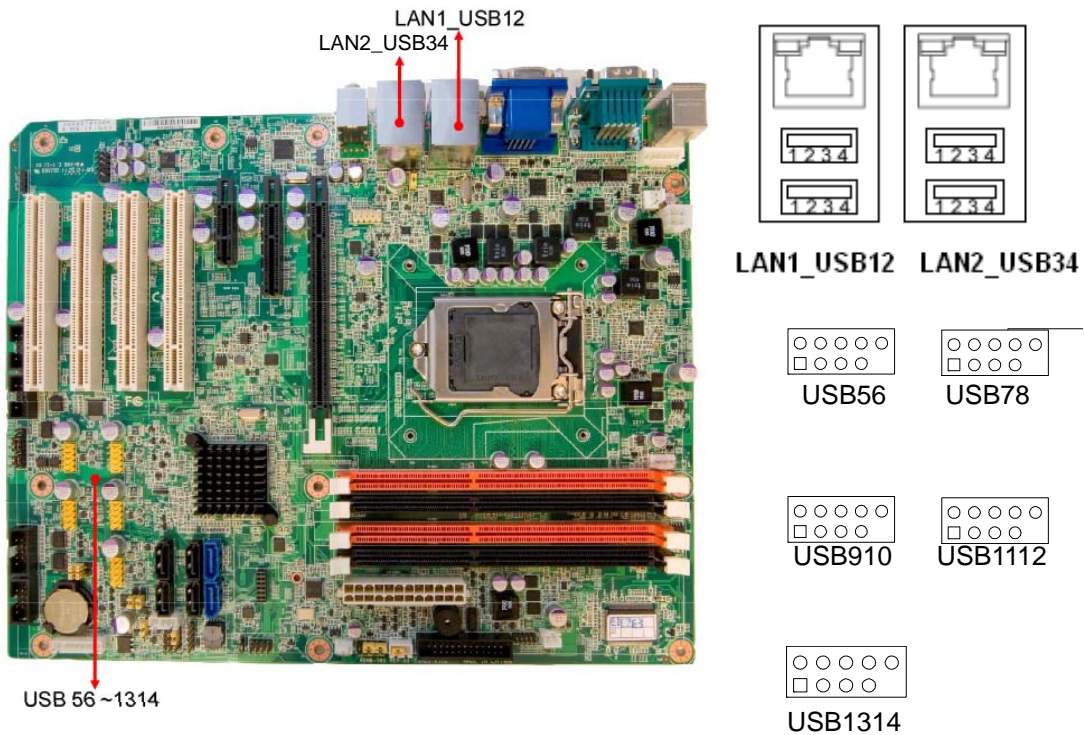

2.4 USB Power Switch

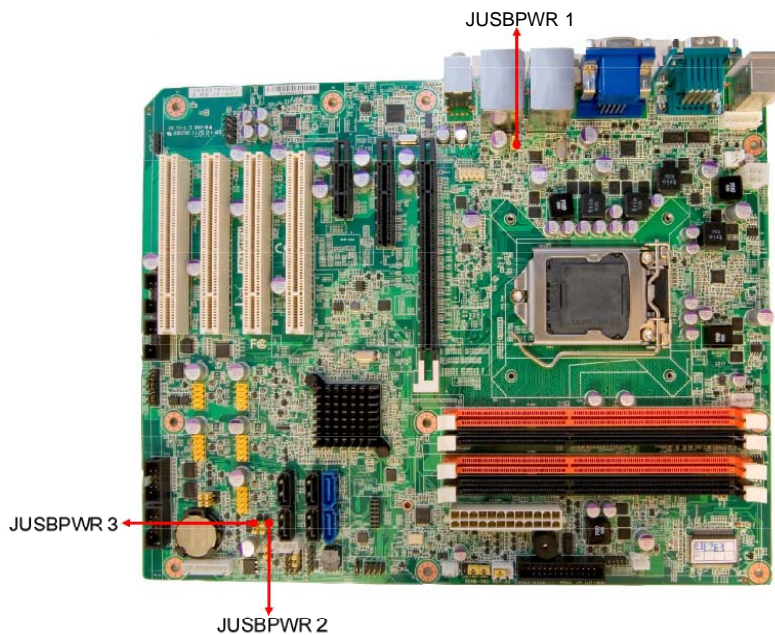

Jumper	USB Ports
JUSBPWR1	USB port 1~4
JUSBPWR2	USB port 5/6/7/8/11/12
JUSBPWR3	USB port 9/10/13/14

AIMB-781 allows user to set USB power between +5VSB and +5V. When the jumper is set as +5V, the board doesn't support waked from S3 via keyboard or mouse.

Note! When USB power is switched to +5V, it can't be connected with powered KVM.



2.5 VGA Connector and DVI-D Connector (VGA1+DVI1)

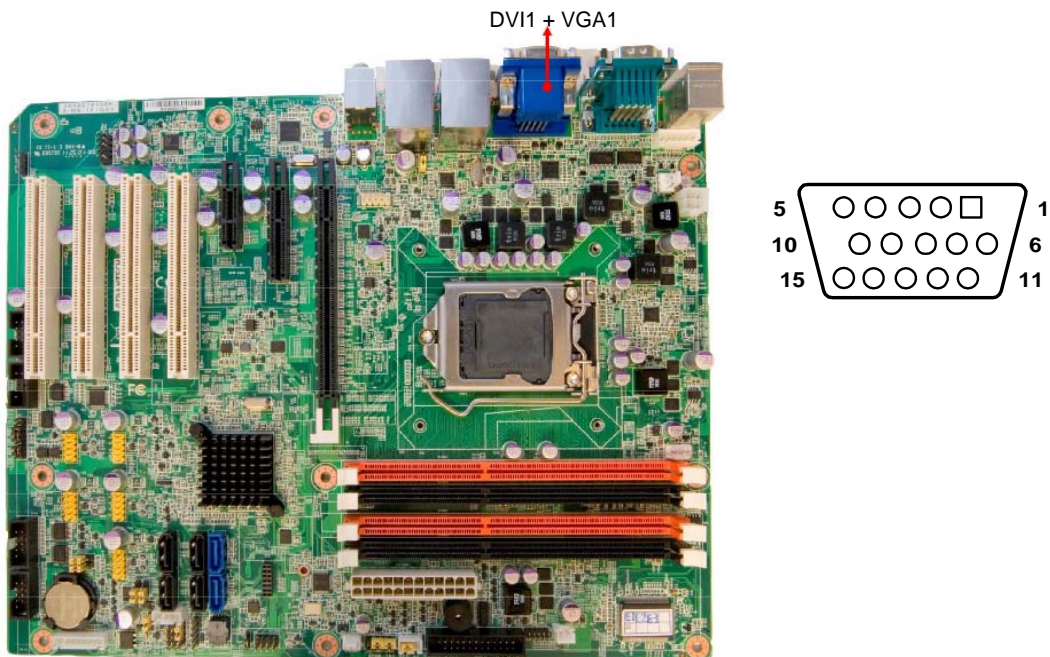

The AIMB-781 includes both VGA and DVI-D interface that can drive conventional CRT and LCD displays. Pin assignments of VGA1 and DVI1 are detailed in Appendix B.

2.6 Serial Ports (COM1, COM2, COM3, COM4, COM5 & COM6)

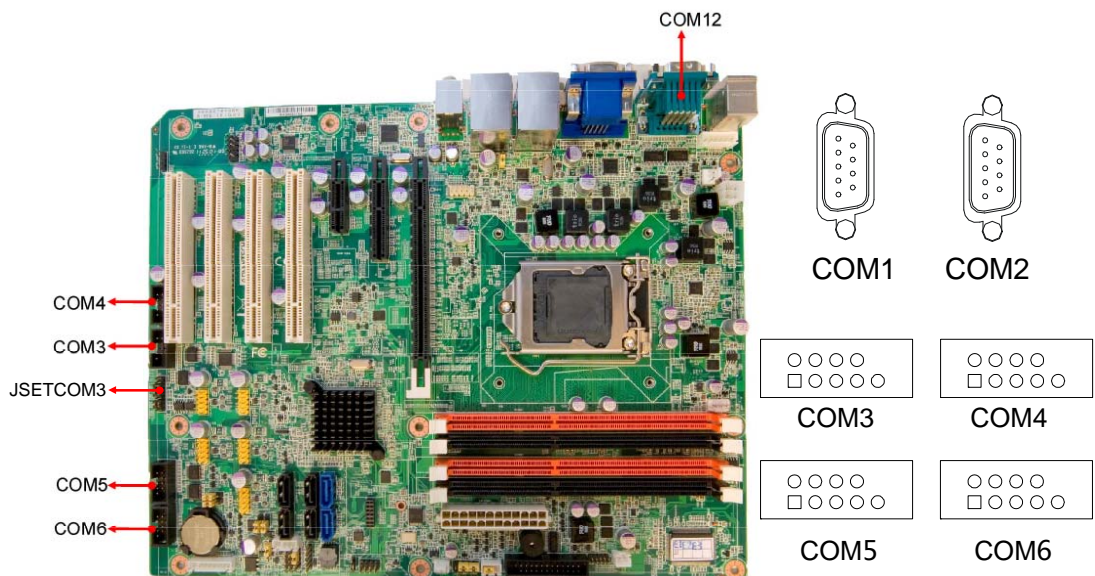

The AIMB-781 offers Six serial ports (two on the rear panel and four onboard) for QG2 version and two serial port for QVG version. JSETCOM3 is used to select the RS232/422/485 mode for COM3 on QG2 version. These ports can connect to a serial mouse, printer or communications network. The IRQ and address ranges for those ports are fixed. However, if you want to disable the port or change these parameters later, you can do this in the system BIOS setup. Different devices implement the RS-232/422/485 standards in different ways. If you are having problems with a serial device, please be sure to check the pin assignments for the connector.

2.7 PS/2 Keyboard and Mouse Connector (KBMS1)

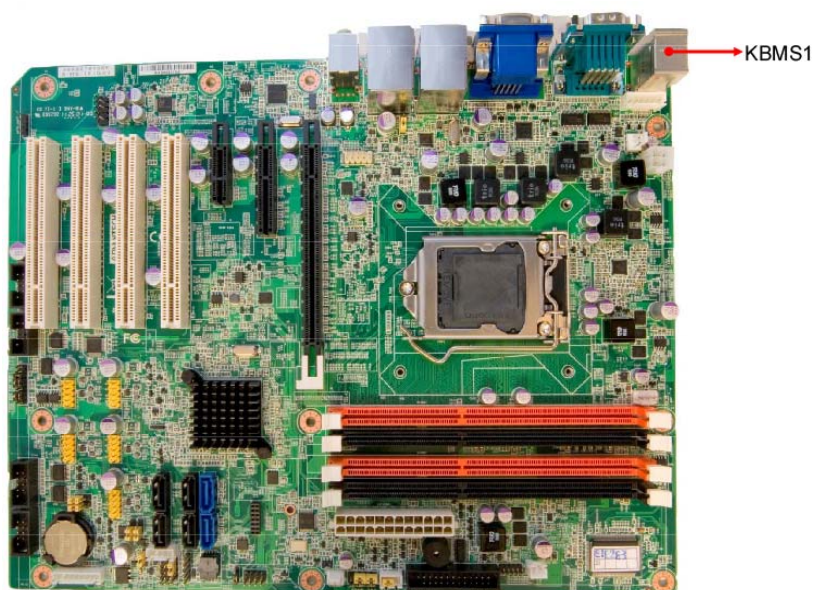

Two 6-pin mini-DIN connectors (KBMS1) on the rear panel of the motherboard provide PS/2 keyboard and mouse connections.

2.8 External Keyboard & Mouse (KBMS2)

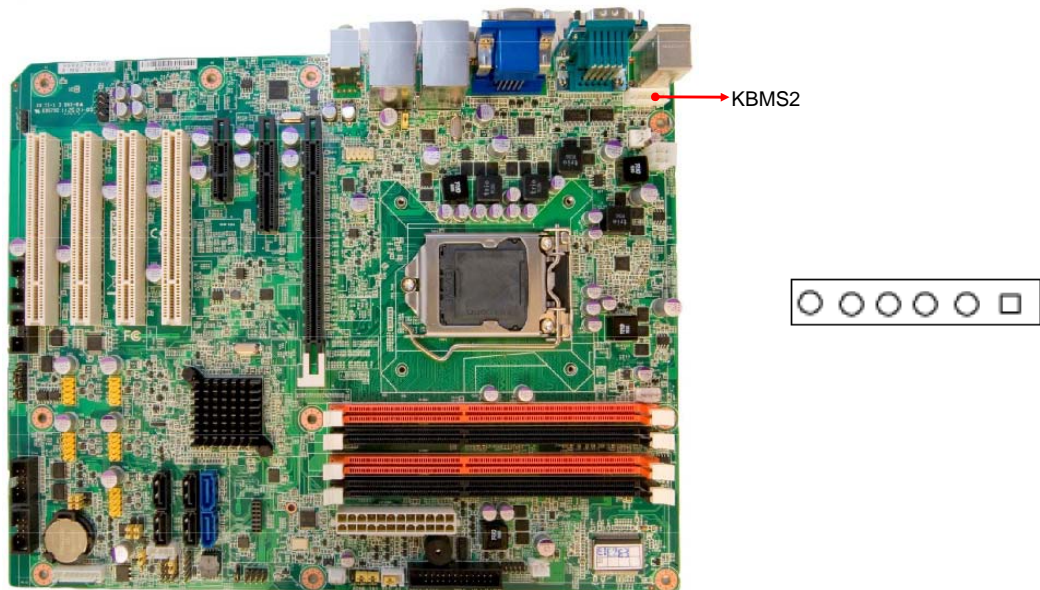

There is also an extra onboard external keyboard and mouse connector on the motherboard. This gives system integrators greater flexibility in designing their systems.

2.9 CPU Fan Connector (CPUFAN1)

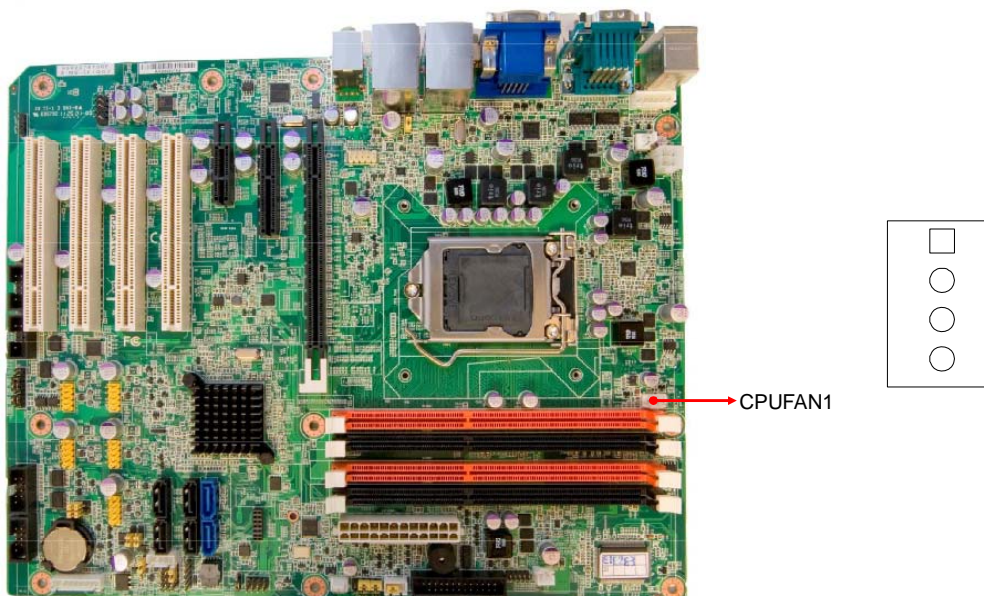

If a fan is used, this connector supports cooling fans that draw up to 500 mA (6 W).

2.10 System FAN Connector (SYSFAN1 and SYSFAN2)

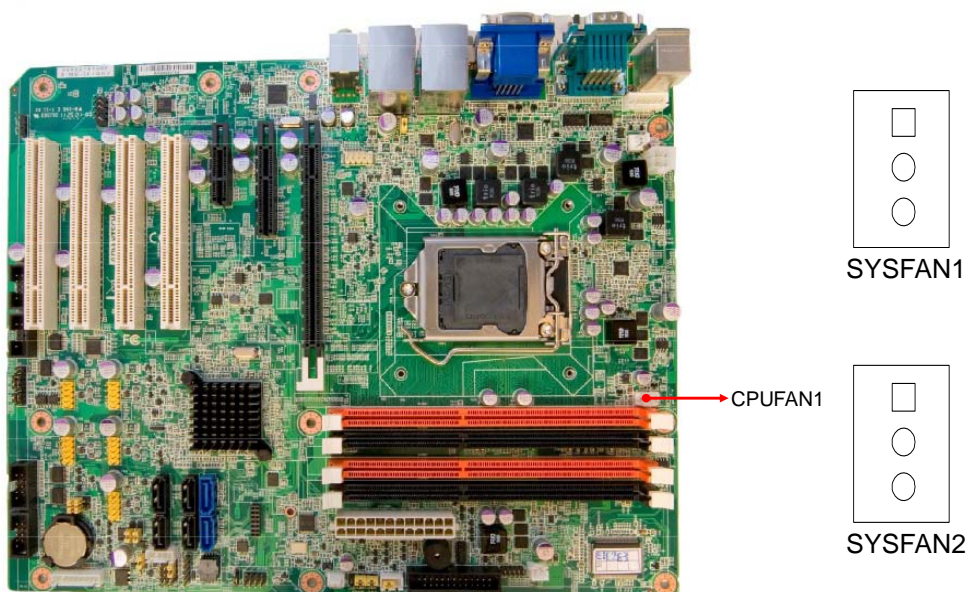

If a fan is used, this connector supports cooling fans that draw up to 500 mA (6 W).

2.11 Front Panel Connectors (JFP1, JFP2 & JFP3)

There are several external switches and LEDs to monitor and control the AIMB-781.

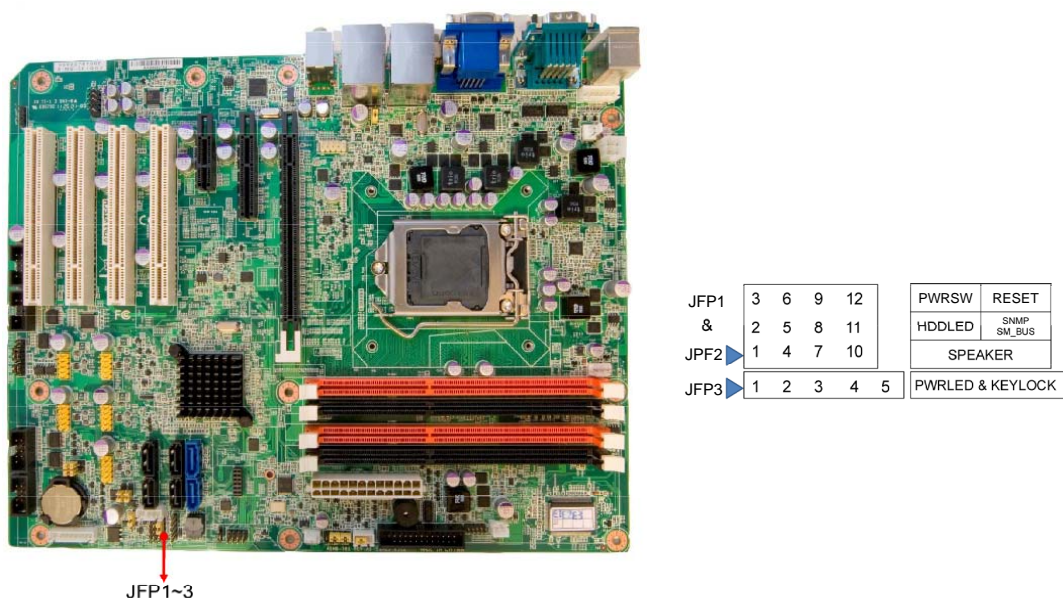

2.11.1 Power LED and Keyboard Lock (JFP3)

JFP3 is a 5-pin connector for the power LED. Refer to Appendix B for detailed information on the pin assignments. If a PS/2 or ATX power supply is used, the system's power LED status will be as indicated as follows.

Table 2.1: PS/2 or ATX power supply LED status

Power mode	LED (PS/2 power)	LED (ATX power)
System On	On	On
System Suspend	Fast flashes	Fast flashes
System Off	Off	Slow flashes
System Off in deep sleep	Off	Off

2.11.2 External Speaker (JFP2 pins 1, 4, 7 & 10)

JFP2 is a 8-pin connector for an external speaker. The AIMB-781 provides an onboard buzzer as an alternative. To enable the buzzer, set pins 7-10 as closed.



2.11.3 HDD LED Connector (JFP2 pins 2 & 5)

You can connect an LED to connector JFP2 to indicate when the HDD is active.

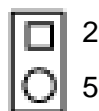

2.11.4 SNMP SM_Bus connector (JFP2 pins 8 & 11)

AIMB-781 supports Advantech SNMP-1000 module for providing a platform independent system management. When you're installing SNMP-1000 module on AIMB-781, please connect it to pins 8 and 11 of JFP2.

2.11.5 ATX Soft Power Switch (JFP1 pins 3 & 6)

If your computer case is equipped with an ATX power supply, you should connect the power on/off button on your computer case to pins 3 and 6 of JFP1. This connection enables you to turn your computer on and off.

2.11.6 Reset Connector (JFP1 pins 9 & 12)

Many computer cases offer the convenience of a reset button.

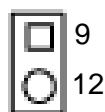

2.12 Line Out, Mic In Connector (AUDIO1)

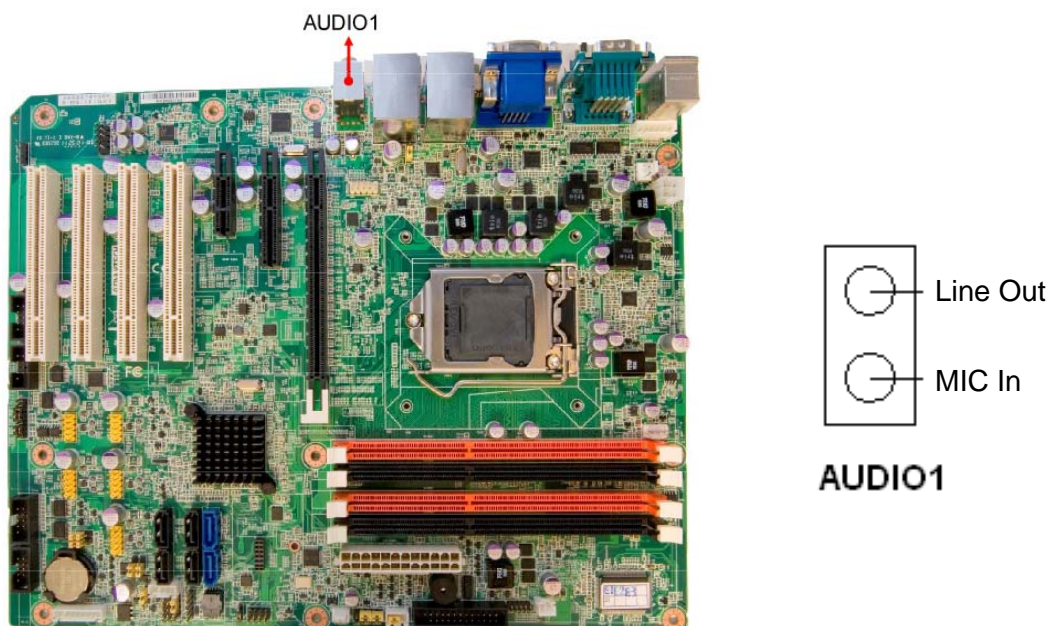

Line Out can be connected to external audio devices like speakers or headphones. Mic In can be connected to a microphone.

2.13 8-pin Alarm Board Connector (VOLT1)

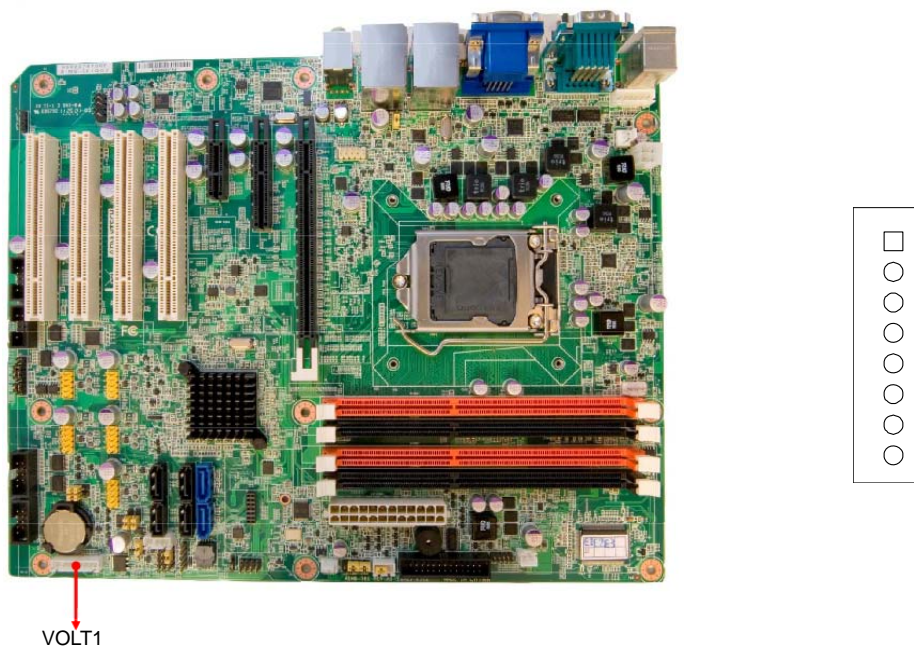

VOLT1 connects to the alarm board of Advantech chassis. These alarm boards give warnings if a power supply or fan fails, if the chassis overheats, or if the backplane malfunctions.

2.14 Case Open Connector (JCASE1)

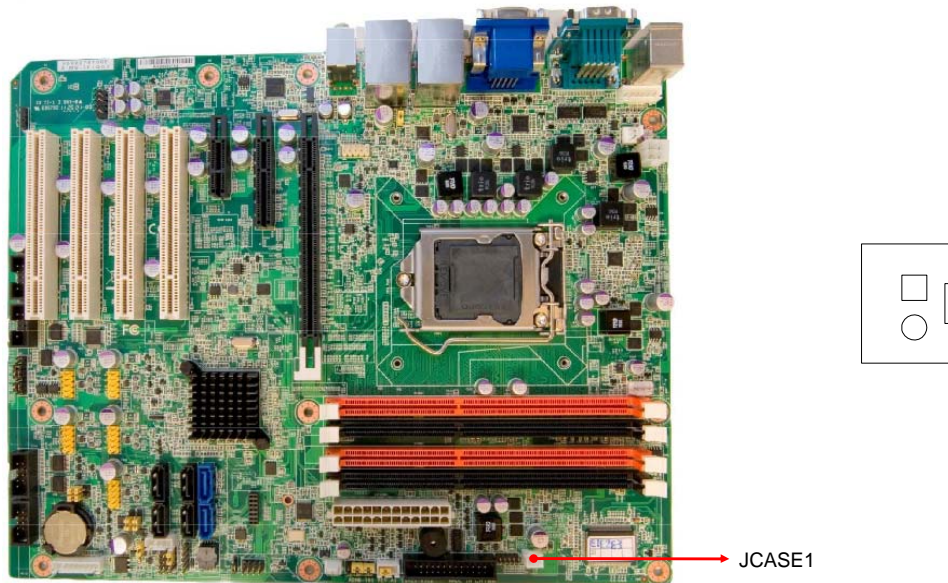

JCASE1 is for chassis with a case open sensor. The buzzer on the motherboard sounds if the case is opened.

2.15 Front Panel LAN Indicator Connector (LAN_LED1)

Table 2.2: Front Panel LAN Indicator Connector

LAN Mode	Indicator
G-LAN Link ON	Green ON
G-LAN Active	Green Flash
G-LAN Link Off	Green OFF

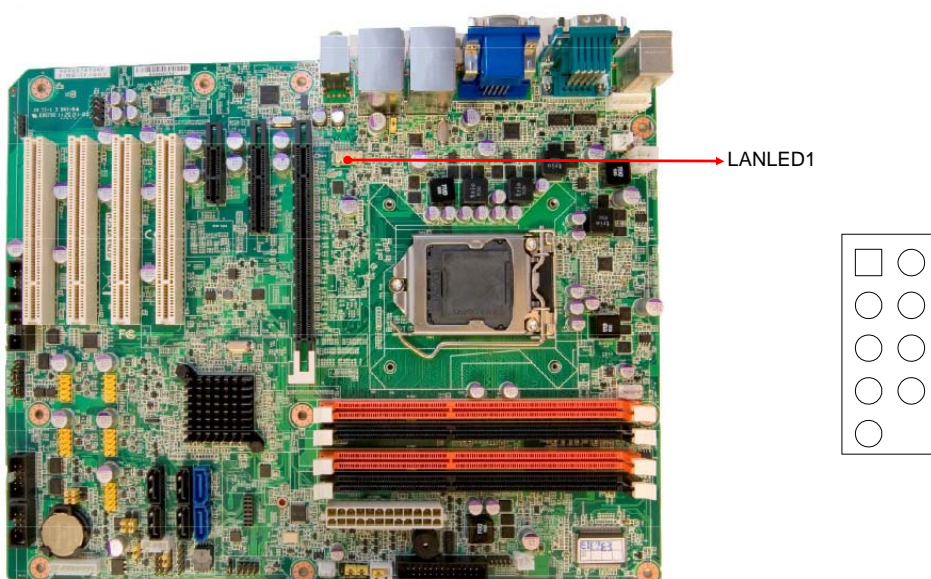

2.16 Serial ATA Interface (SATA1, SATA2, SATA3, SATA4, SATA5 & SATA6)

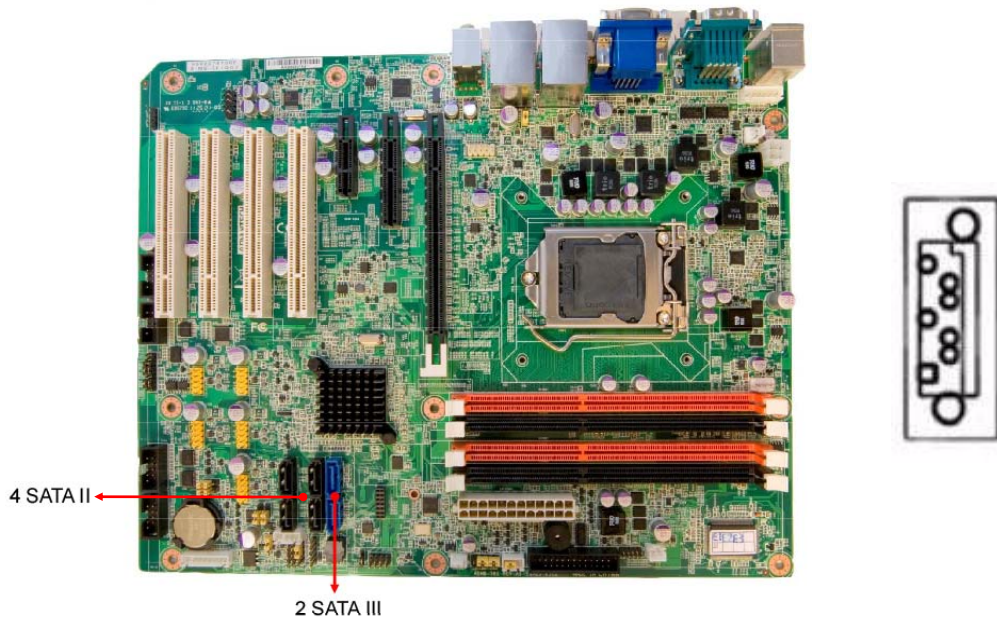

AIMB-781 features two high performance serial ATA III interfaces (up to 600 MB/s, blue connector) and four serial ATA II interfaces (up to 300 MB/s, black connector) for QG2 version with long, thin, easy-to-run SATA cables.

Note!



1. *AIMB-781 on board SATA only supports Fedora 14 and 15 and SATA mode in BIOS should be set as AHCI mode.*
2. *If SATA mode is set as IDE mode, when user is installing Fedora 14 and 15, ODD has been connected on SATA port 3~6.*

2.17 PCI Slots (PCI 1 ~ PCI 4)

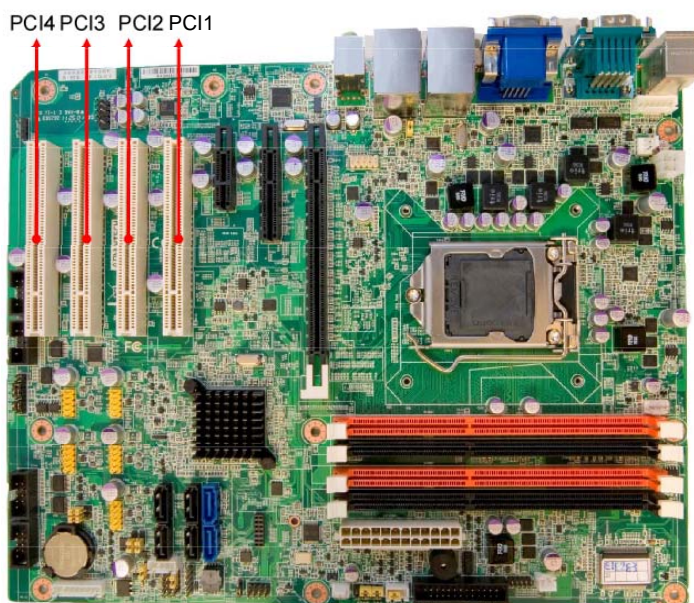

The AIMB-781 provides four 32-bit / 33 MHz PCI slots.

2.18 PCIe x16 Expansion Slot (PCIEX16_1)

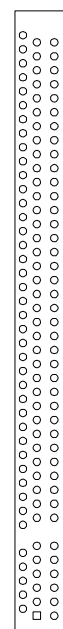
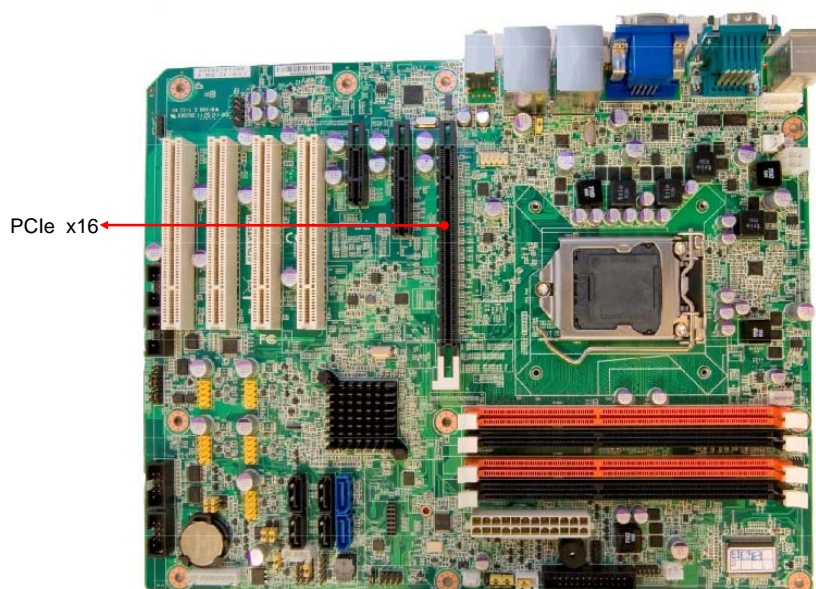

The AIMB-781 provides a PCIe x16 slot for users to install add-on VGA cards when their applications require higher graphics performance than the CPU embedded graphics controller can provide.

2.19 PCIeX4_1

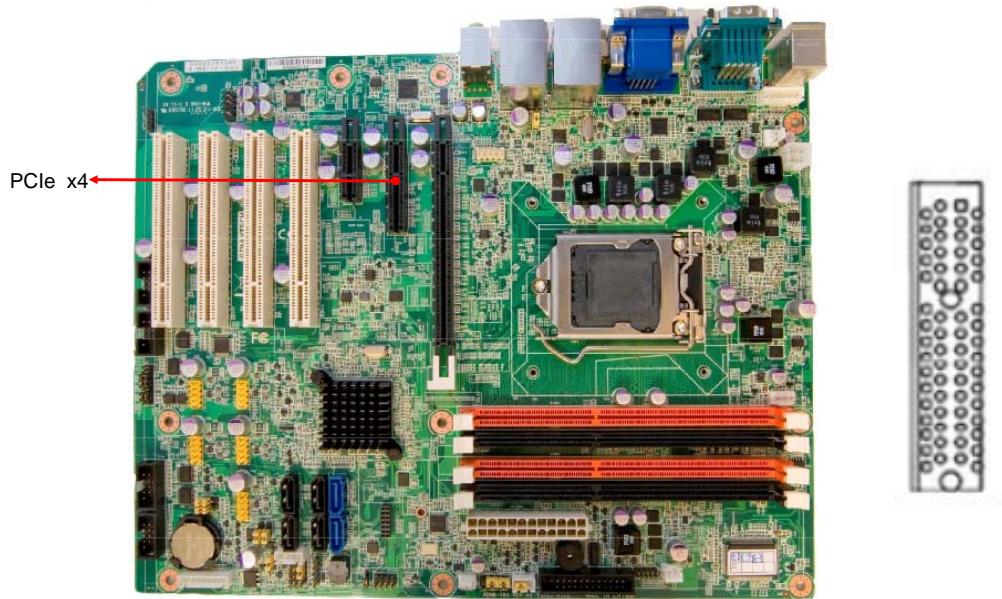

2.20 PCIeX1_1

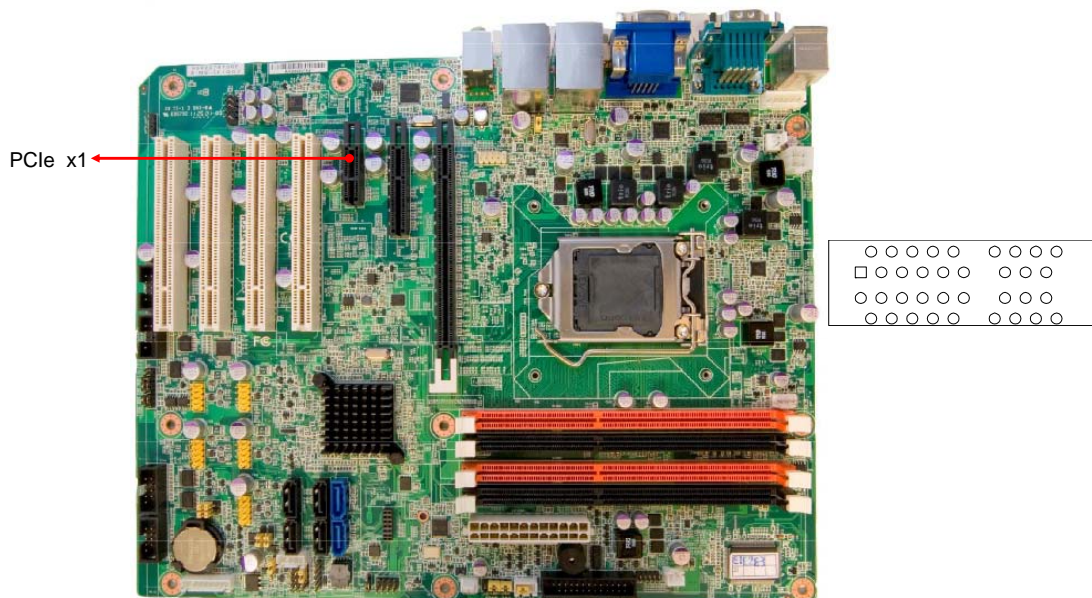

2.21 Auxiliary 4-pin power connector (ATX12V1)

To ensure the enough power is supplied to the motherboard, one auxiliary 4-pin power connector is available on the AIMB-781. ATX1 must be used to provide sufficient 12 V power to ensure the stable operation of the system.

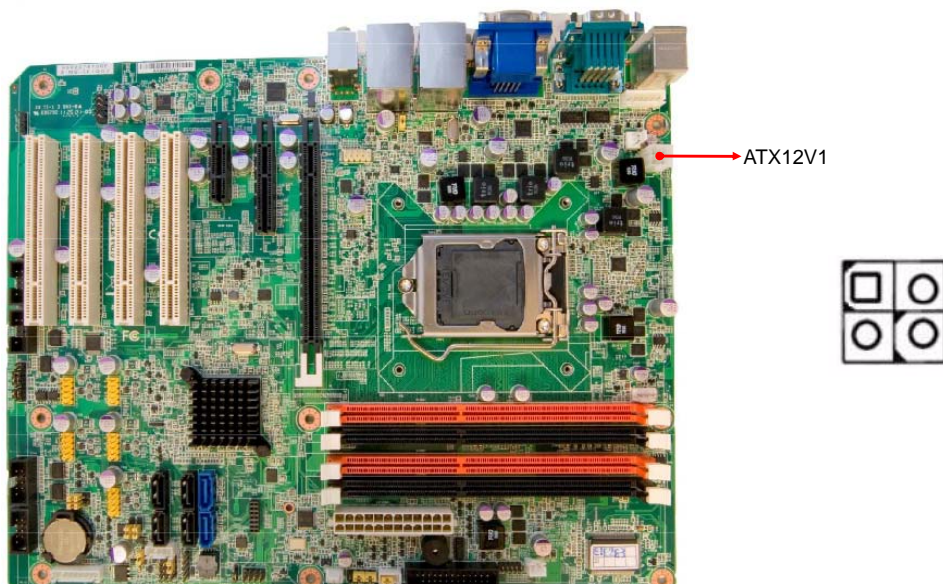

2.22 SPI Flash connector(SPI_CN1)

SPI flash card pin header which can flash BIOS while AIMB-781 can not be power on and ensures platform integrity.

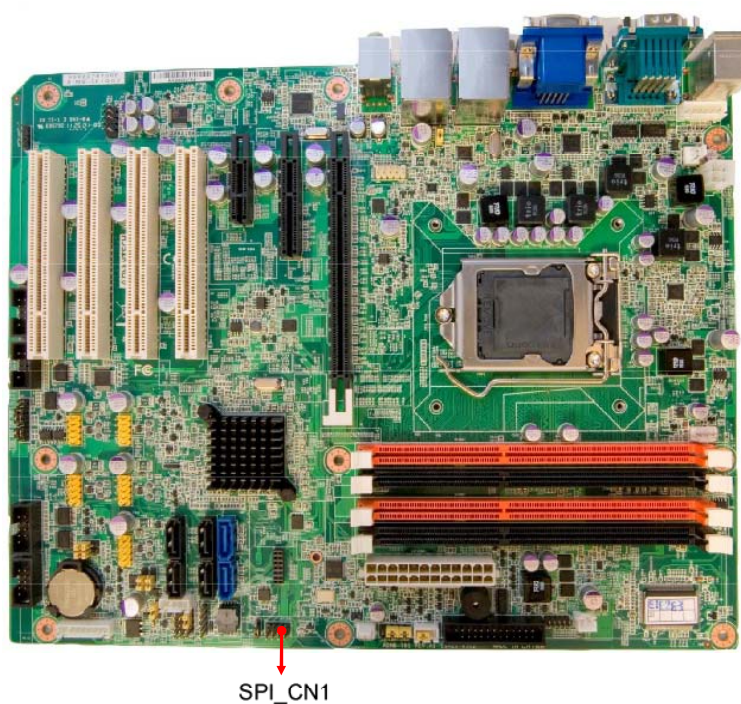

2.23 Low Pin Count Connector (LPC1)

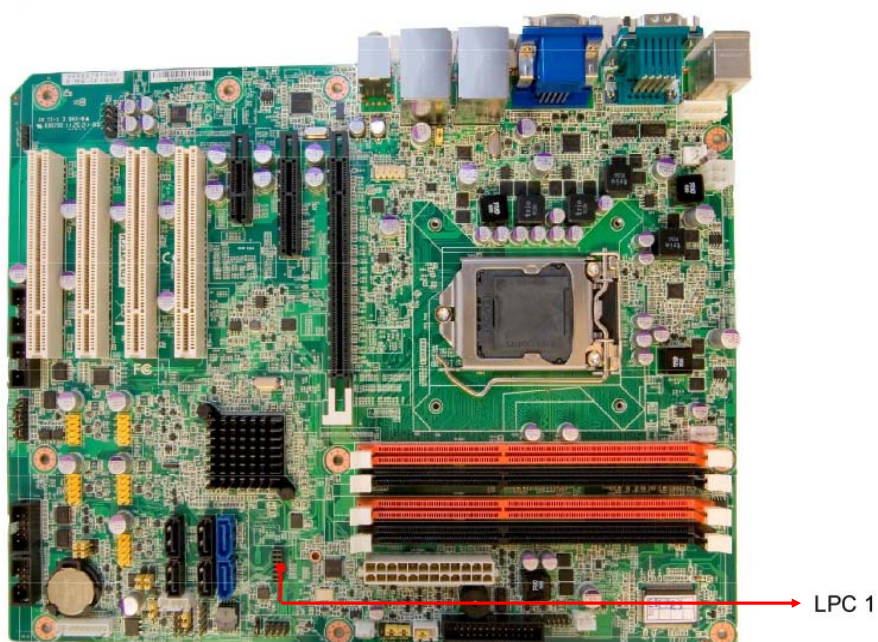

Table 2.3: Advantech LPC Module List

P/N	Description
PCA-COM232-00A1E	4 Ports RS-232 Module
PCA-COM485-00A1E	4 Ports RS-485/422 Module
PCA-TPM-00A1E	TPM Module

Chapter 3

BIOS Operation

3.1 Introduction

AMIBIOS has been integrated into myriad motherboards for decades. In the past, people often referred to the AMIBIOS setup menu as BIOS, BIOS setup or CMOS setup.

With the AMIBIOS Setup program, you can modify BIOS settings and control the special features of your computer. The Setup program uses a number of menus for making changes and turning the special features on or off. This chapter describes the basic navigation of the AIMB-781 setup screens.

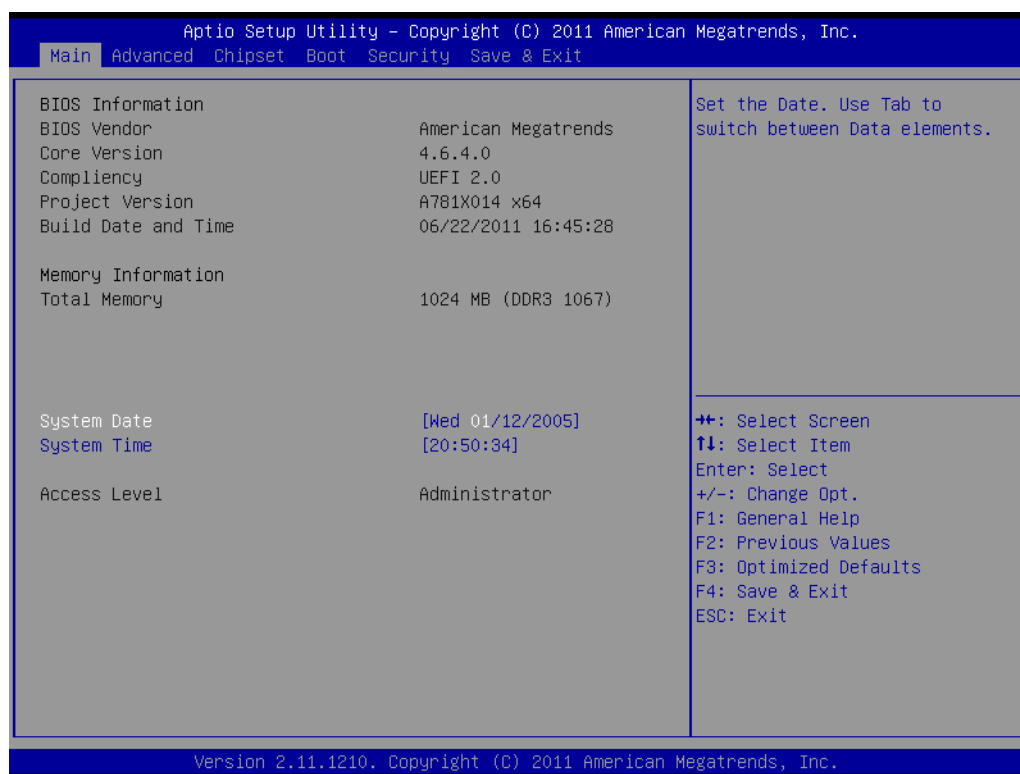

Figure 3.1 Main setup screen

AMI's BIOS ROM has a built-in Setup program that allows users to modify the basic system configuration. This information is stored in NVRAM area so it retains the Setup information when the power is turned off.

3.2 Entering BIOS Setup

Press or <F2> to enter AMI BIOS Setup Utility, the Main Menu will appear on the screen. Use arrow keys to select among the items and press <Enter> to accept or enter the sub-menu.

When users first enter the BIOS Setup Utility, they enter the Main setup screen. Users can always return to the Main setup screen by selecting the Main tab. There are two Main Setup options. They are described in this section. The Main BIOS Setup screen is shown below.

3.2.1 Main Menu

Press at bootup to enter AMI BIOS CMOS Setup Utility, the Main Menu will appear on the screen. Use arrow keys to select among the items and press <Enter> to accept or enter the sub-menu.



Figure 3.2 Main setup screen

The Main BIOS setup screen has two main frames. The left frame displays all the options that can be configured. Grayed-out options cannot be configured; options in blue can be. The right frame displays the key legend.

Above the key legend is an area reserved for a text message. When an option is selected in the left frame, it is highlighted in white. Often a text message will accompany it.

3.2.2 System time / System date

Use this option to change the system time and date. Highlight System Time or System Date using the <Arrow> keys. Enter new values through the keyboard. Press the <Tab> key or the <Arrow> keys to move between fields. The date must be entered in MM/DD/YY format. The time must be entered in HH:MM:SS format.

3.3 Advanced BIOS Features Setup

Select the Advanced tab from the AIMB-781 setup screen to enter the Advanced BIOS setup screen. You can select any of the items in the left frame of the screen, such as CPU configuration, to go to the sub menu for that item. You can display an Advanced BIOS Setup option by highlighting it using the <Arrow> keys. All Advanced BIOS Setup options are described in this section. The Advanced BIOS Setup screens are shown below. The sub menus are described on the following pages.

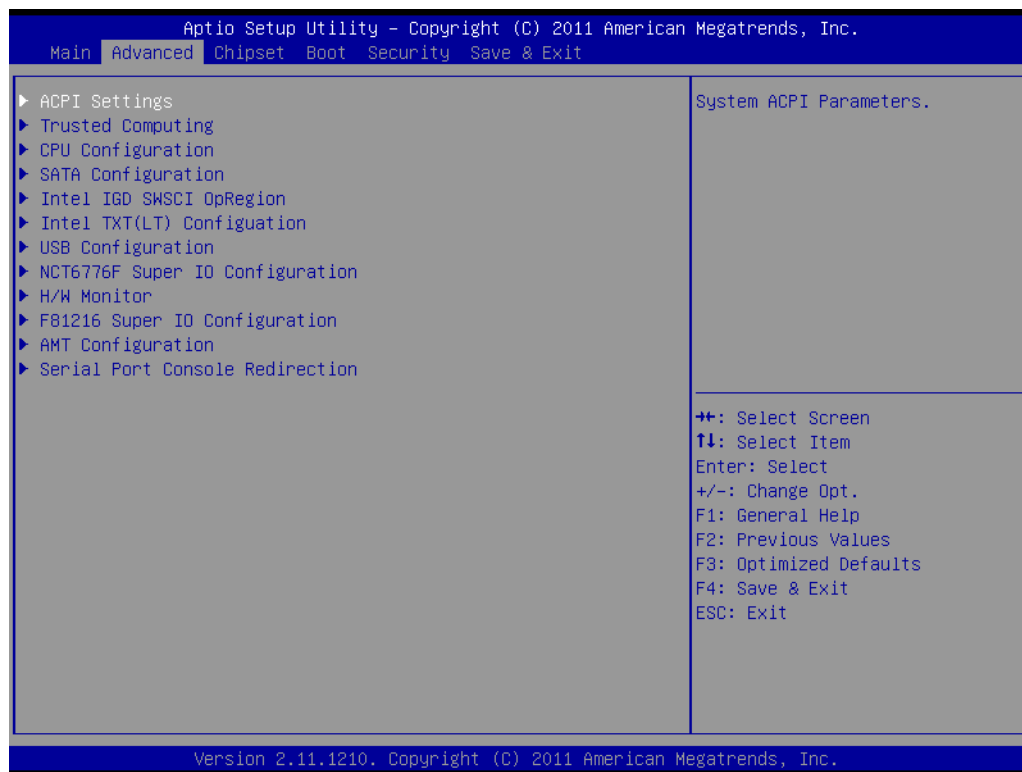

Figure 3.3 Advanced BIOS features setup screen

3.3.1 ACPI Settings

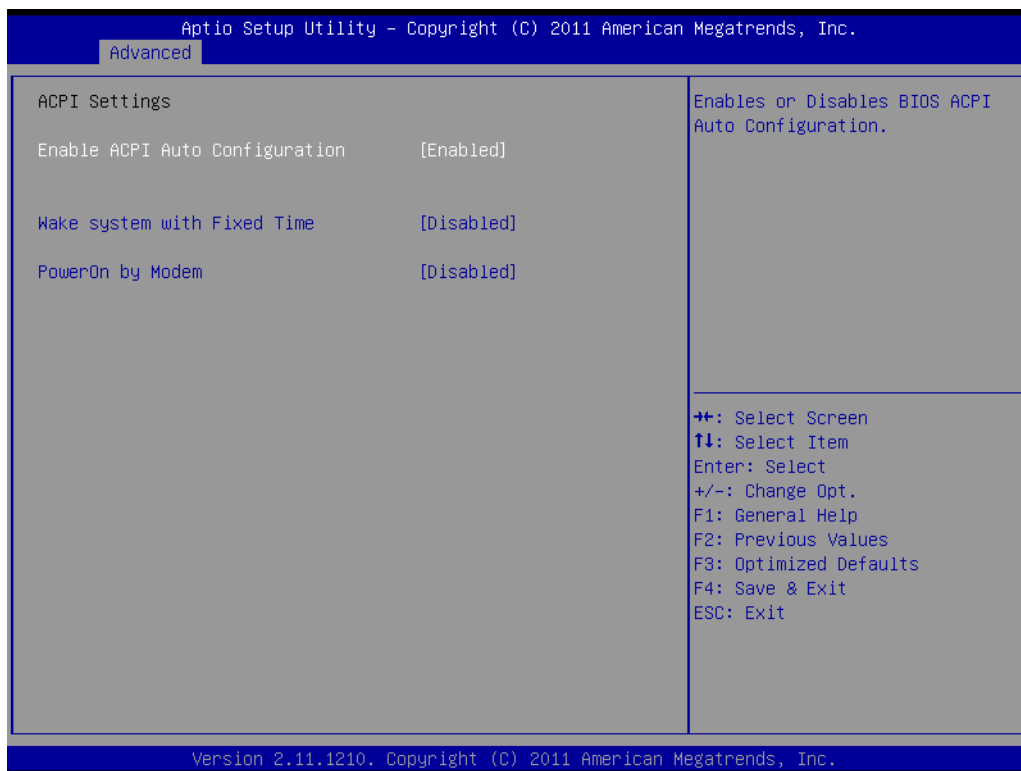

Figure 3.4 ACPI Settings

Enable ACPI Auto Configuration

"Enable or disable" ACPI Auto Configuration.

Wake System with Fixed Time

"Enable" and "Disable" Wake System with Fixed Time.

PowerOn by Modem

"Enable" and "Disable" PowerOn by Modem

3.3.2 Trusted Computing

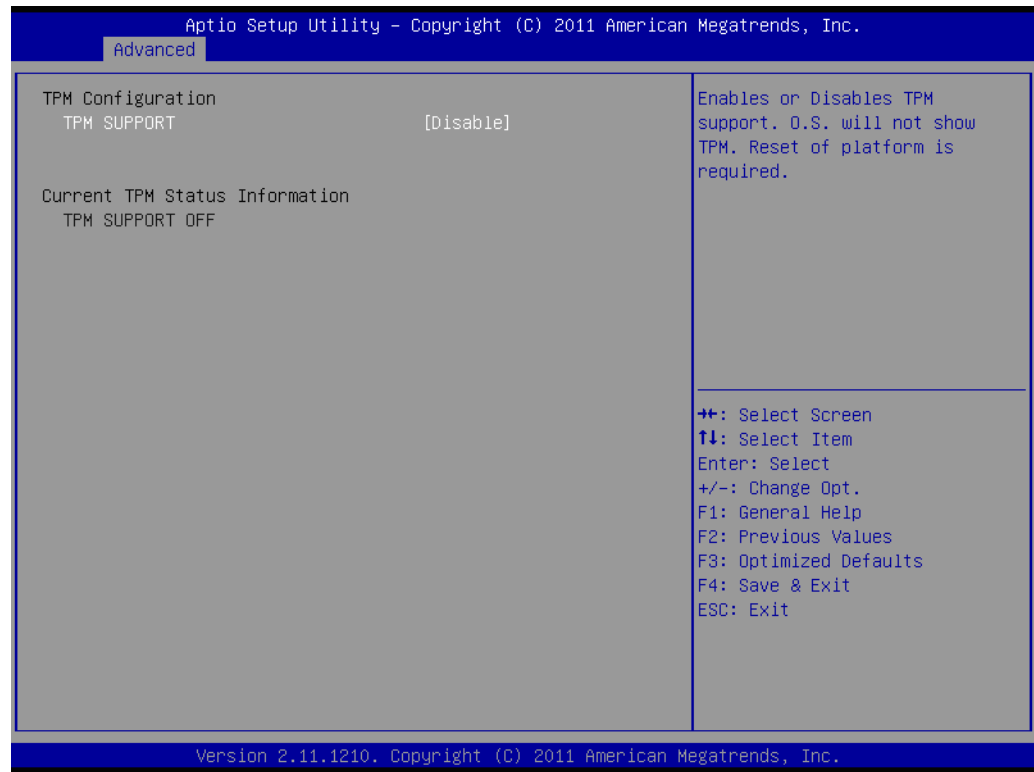

Figure 3.5 TPM Settings

TPM Support

“Enable or disable” TPM Support. You can purchase Advantech LPC TPM module to enable TPM function. P/N: PCA-TPM-00A1E

3.3.3 CPU Configuration

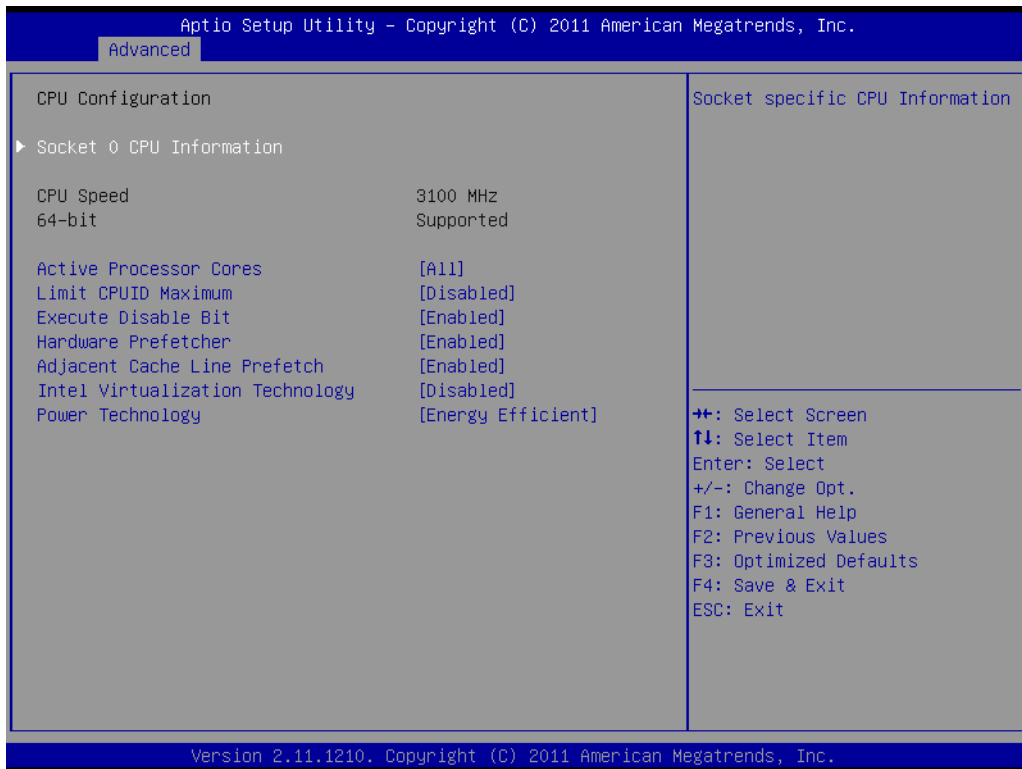

Figure 3.6 CPU Configuration

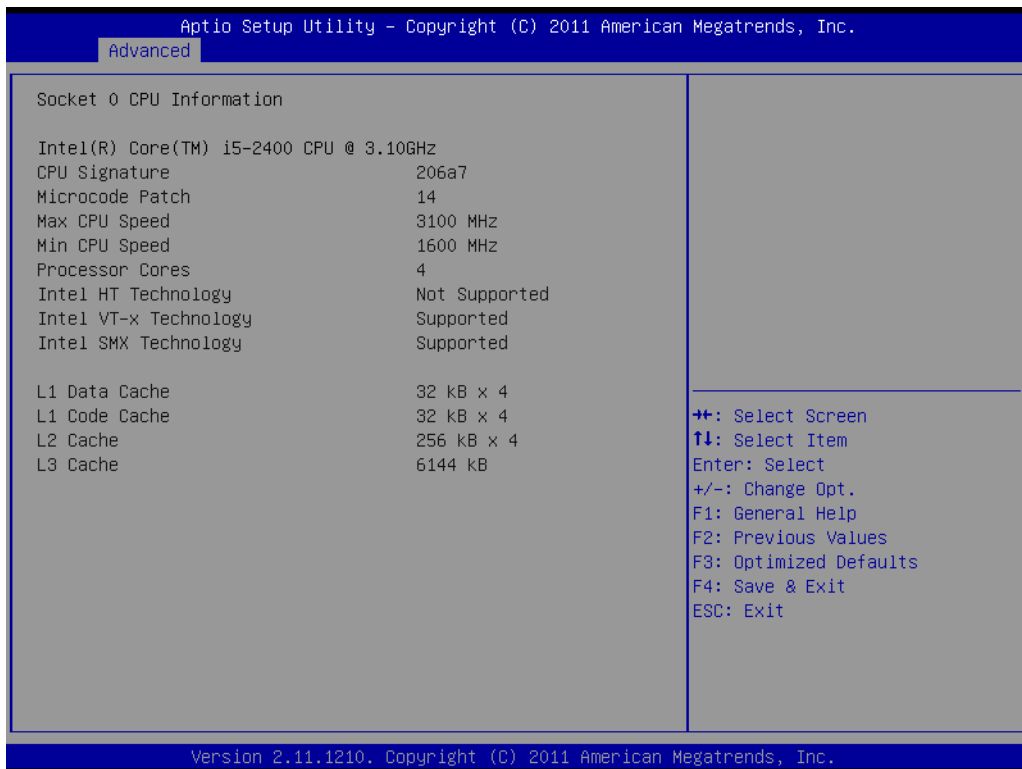

Figure 3.7 CPU Information

Active Processor Core

Use this to select how many processor cores you want to activate when you are using a dual or quad core processor.

Limit CPUID Maximum

Setting this item to [Enable] allows legacy operating systems to boot even without support for CPUs with extended CPUID functions.

Execute Disable Bit

This item specifies the Execute Disable Bit Feature. The settings are Enabled and Disabled. The Optimal and Fail-Safe default setting is Enabled. If Disabled is selected, the BIOS forces the XD feature flag to always return to 0.

Hardware Prefetcher

Hardware Prefetcher is a technique that fetches instructions and/or data from memory into the CPU cache memory well before the CPU needs it, so that it can improve the load-to-use latency. You may choose to enable or disable it.

Adjacent Cache Line Prefetch

The Adjacent Cache-Line Prefetch mechanism, like automatic hardware prefetch, operates without programmer intervention. When enabled through the BIOS, two 64-byte cache lines are fetched into a 128-byte sector, regardless of whether the additional cache line has been requested or not. You may choose to enable or disable it.

Intel Virtualization Technology

This feature is used to enable or disable the Intel Virtualization Technology (IVT) extension. It allows multiple operating systems to run simultaneously on the same system. It does this by creating virtual machines, each running its own x86 operating system.

Power Technology

Default is "Energy Efficient". User can set "EIST", "P-STATE", "C3", "C6" and "Package C State Limit" under "Custom Mode".

3.3.4 SATA Configuration

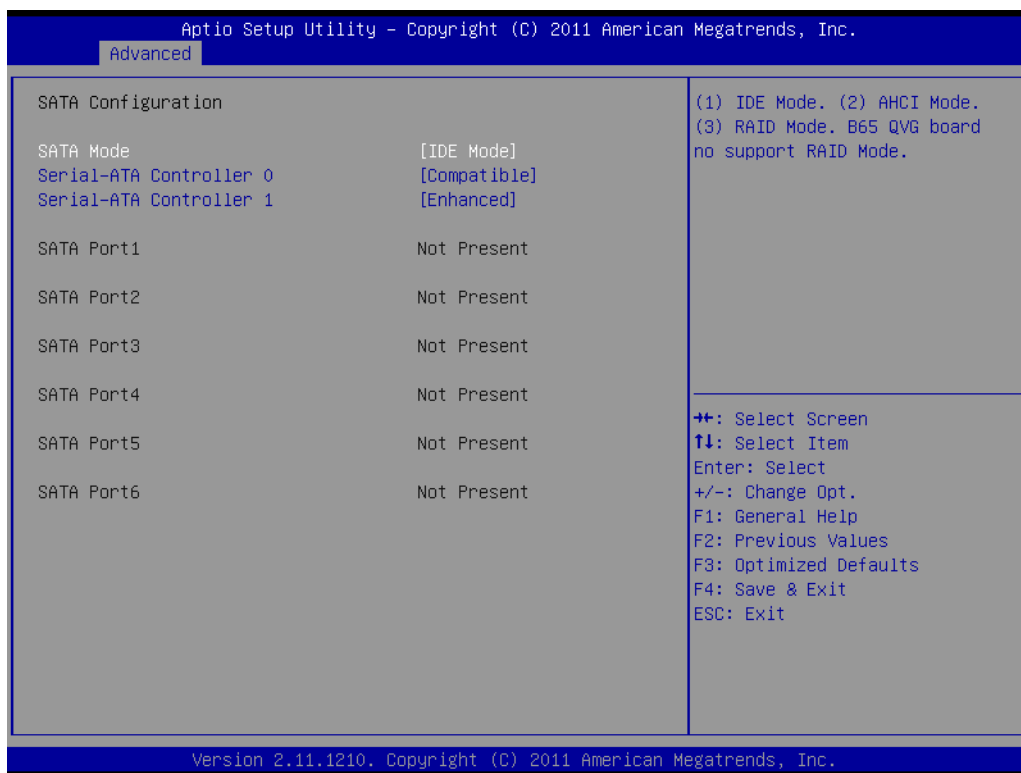

Figure 3.8 SATA Configuration

SATA Mode

This can be configured as IDE, RAID, AHCI, or Disabled. (RAID mode is only for QG2 version)

Serial-ATA Controller 0

This item appears only when you set the SATA Mode item to [IDE Mode]. Set to [Enhanced] to support two SATA 6.0 Gb/s and two SATA 3.0 Gb/s devices. Set to [Compatible] when using Windows 98/NT/2000/MS-DOS. Up to four SATA devices are supported under these operating systems.

Serial-ATA Controller 1

This item appears only when you set the SATA Mode item to [IDE Mode]. Set to [Enhanced] to support two SATA 3.0 Gb/s devices.

3.3.5 Intel IGD SWSCI OpRegion Configuration

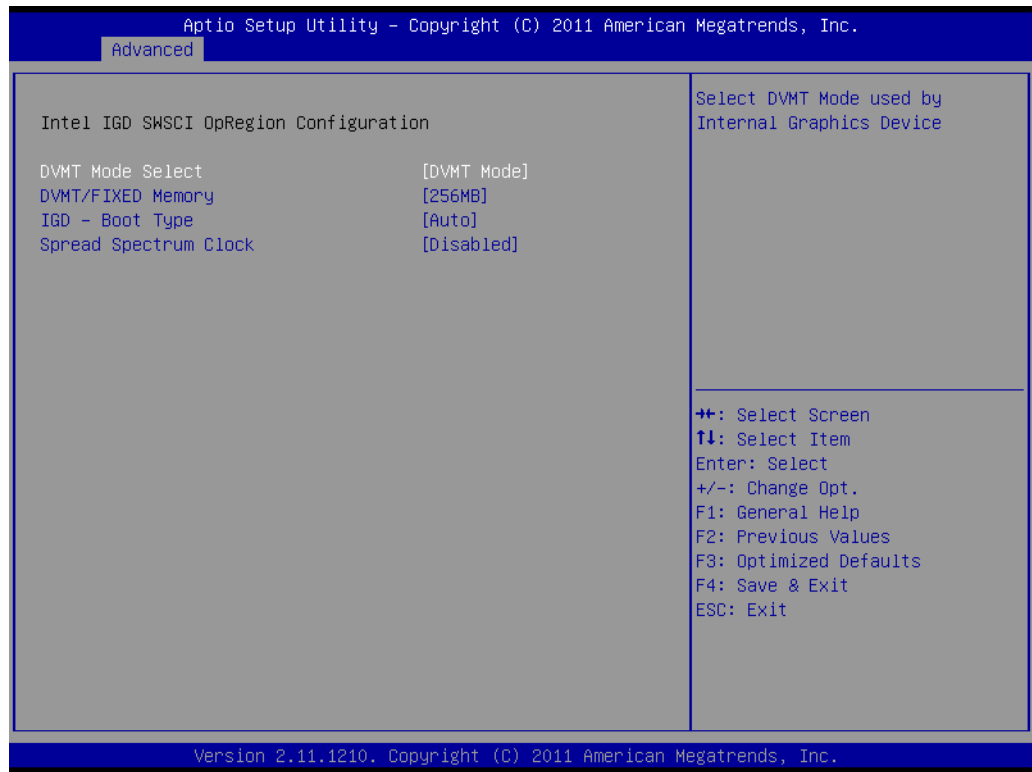

Figure 3.9 Intel IGD SWSCI OpRegion Configuration

DVMT Mode Select

To select "DVMT Mode" by using internal graphics device.

DVMT/FIXED Memory

This item allows user to set Video Memory. There are three options, [128MB]/[256MB]/[Maximum]

IGD - Boot Type

To select the video device which will be activated during post stage.

Spread Spectrum Clock

To enable or disable spread spectrum clock.

3.3.6 Intel TXT(LT) Configuration

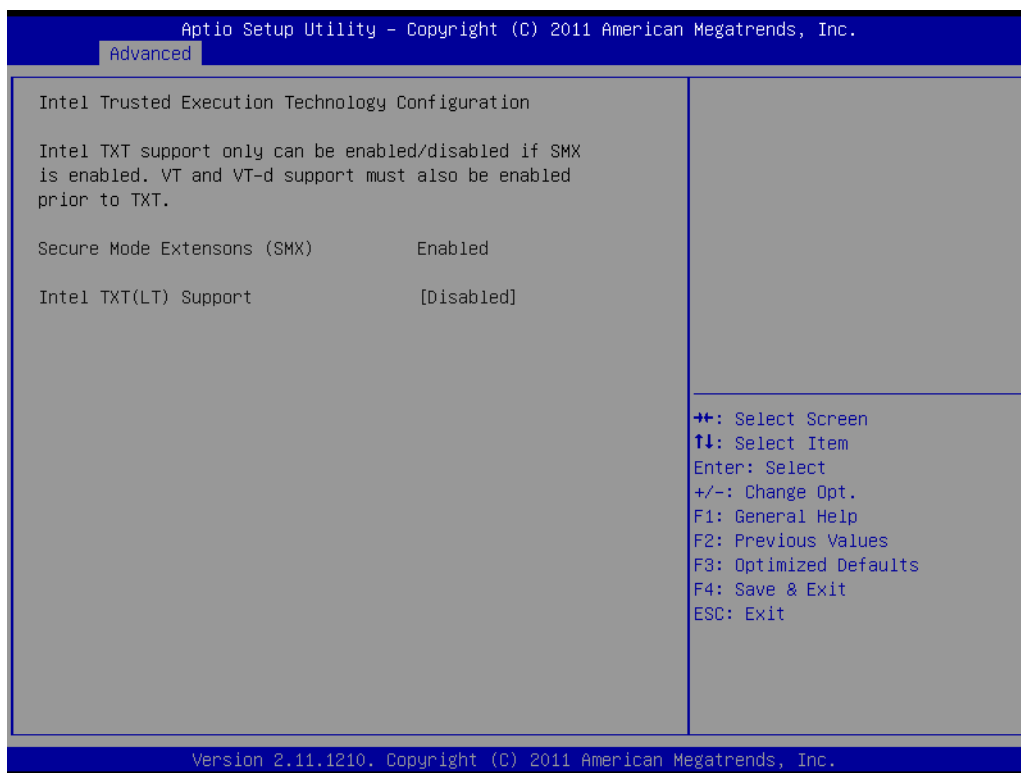

Figure 3.10 Intel Trusted Execution Technology Configuration

Intel Trusted Execution Technology Configuration

To enable or disable Intel Trusted Execution Technology if SMX is enable, and VT-D support must also be enabled prior to TXT.

3.3.7 USB Configuration



Figure 3.11 USB Configuration

Legacy USB Support

This is for supporting USB device under a legacy OS such as DOS. When choosing "AUTO", the system will automatically detect if any USB device is plugged into the computer and enable USB legacy mode when a USB device is plugged and disable USB legacy mode when no USB device is plugged.

EHCI Hand-off

This enables or disables supporting an OS without EHCI hand-off feature.

USB transfer time-out

Allows you to select the USB transfer time-out value. [1,5,10,20sec]

Device reset time-out

Allows you to select the USB device reset time-out value. [10,20,30,40 sec]

Device power-up delay

This item appears only when you set the Device power-up delay item to [manual].

Mass Storage Devices

This item only shows when plugging a USB flash device. User can choose "Auto", "Floppy", "Forced FDD", "Hard Disk" and "CD-ROM" to simulate USB flash device.

3.3.8 NCT6776 Super IO Configuration

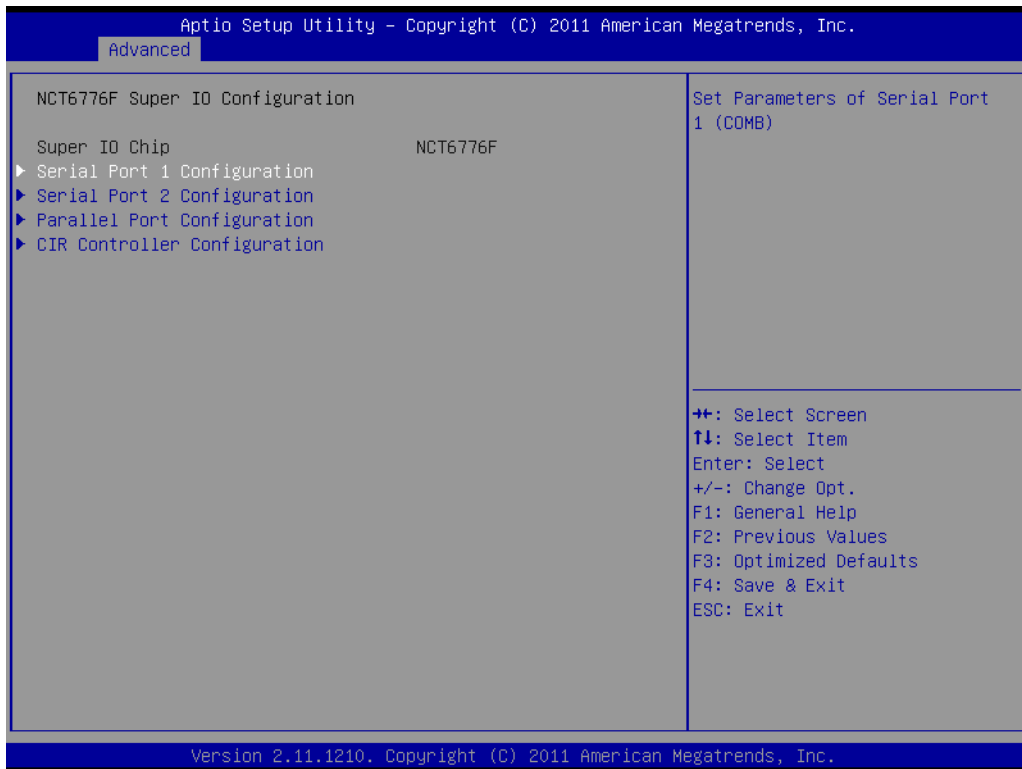

Figure 3.12 Super IO Configuration

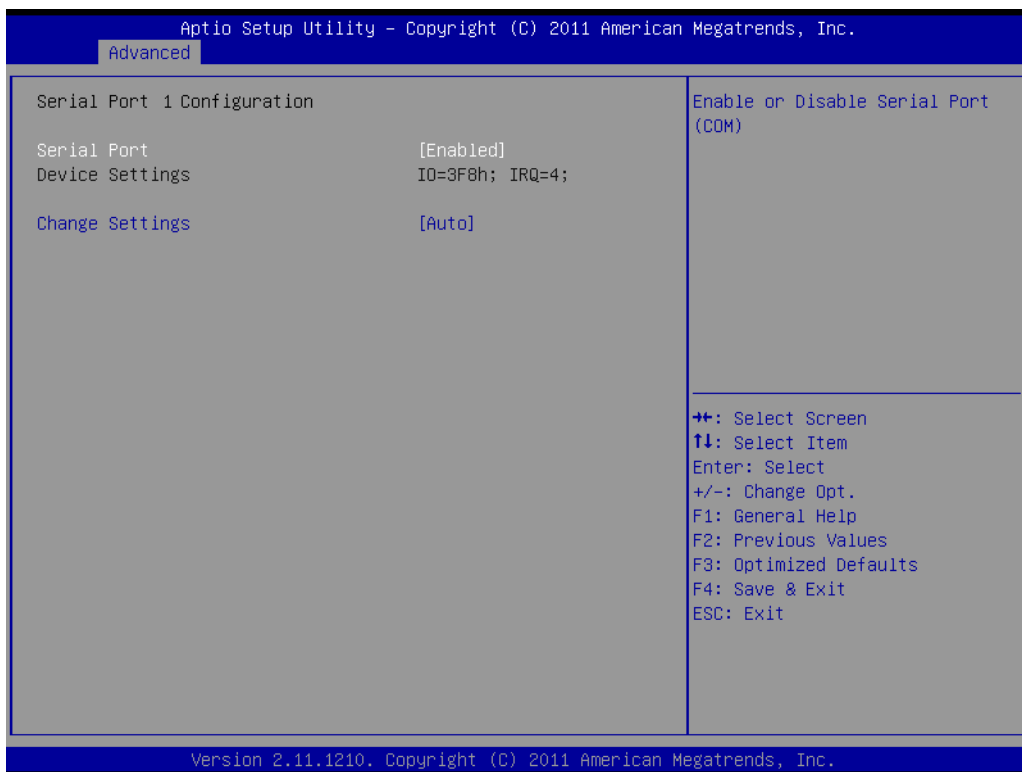

Figure 3.13 Serial Port 1 Configuration



Figure 3.14 Serial Port 2 Configuration

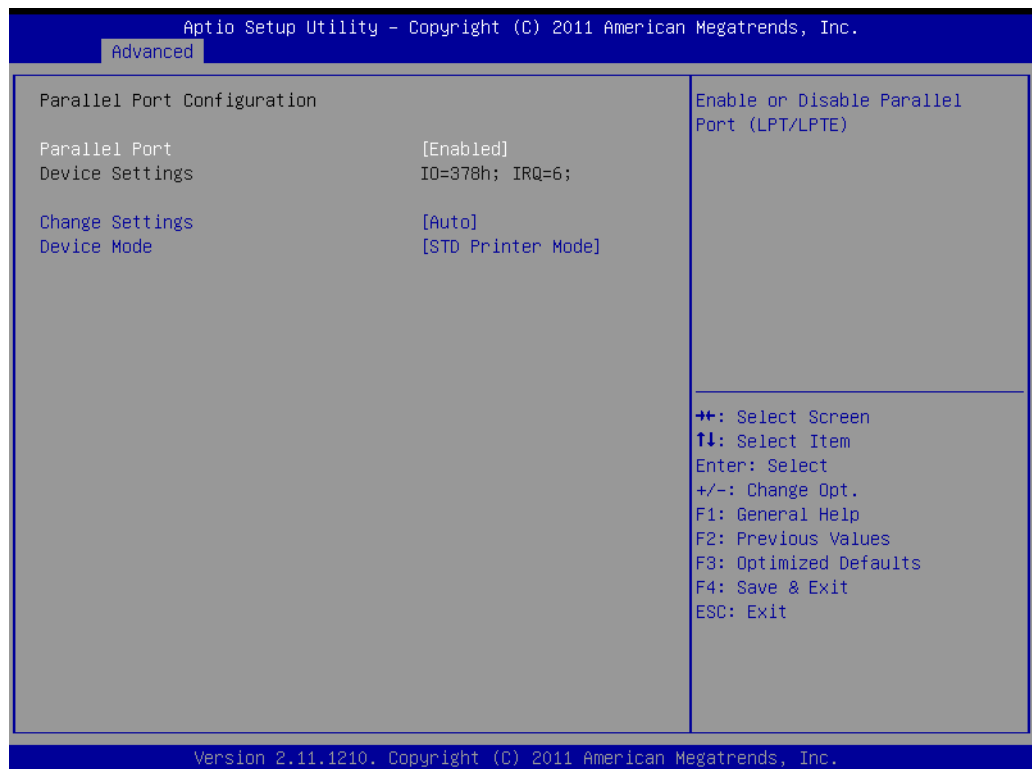

Figure 3.15 Parallel Configuration

Serial Port 1 Configuration

Serial Port

To "enable" or "disable" Serial Port 1.

Change Settings

To select an optimal setting for serial port 1.

Serial Port 2 Configuration

Serial Port

To "enable" or "disable" Serial Port 2.

Change Settings

To select an optimal setting for serial port 2.

Device Mode

Serial port 2 could be selected as "Standard serial port mode", "IrDA 1.0 (HP SIR) mode", or "ASKIR mode".

Parallel Port

To enable or disable Parallel Port.

Change Settings

To select an optimal setting for parallel port.

3.3.9 H/W Monitor

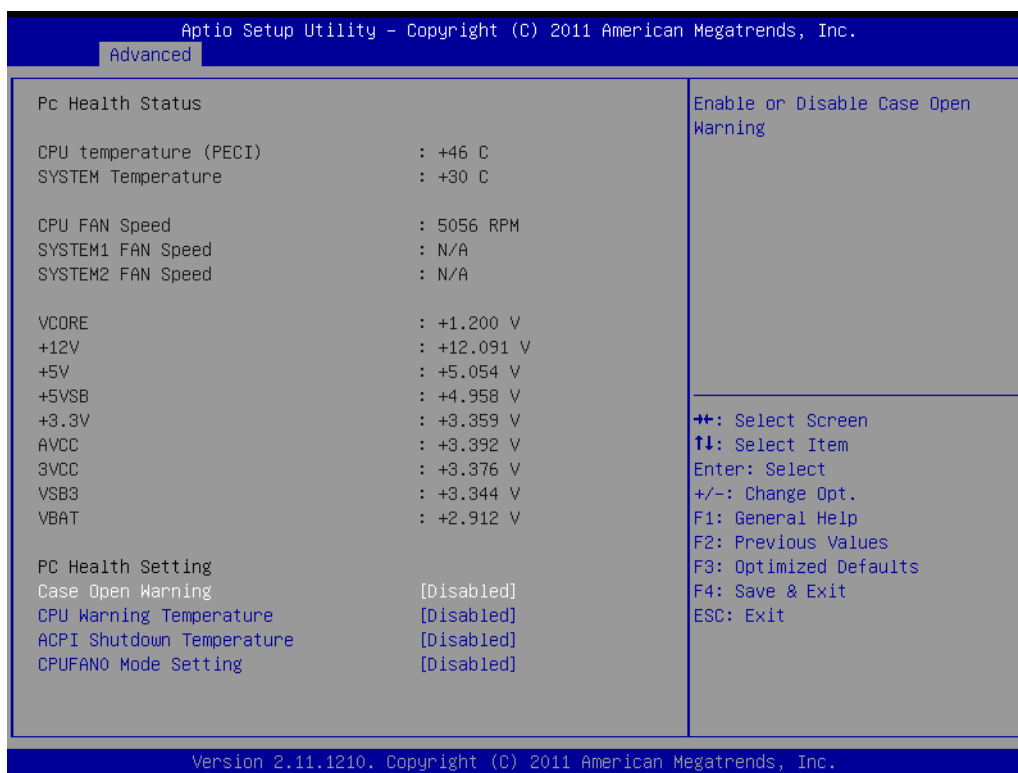

Figure 3.16 PC Health Status

CPU temperature (PECI)

CPU Temperature showed here is CPU T-junction temperature via PECI.

Case Open Warning

Enable/Disable the Chassis Intrusion monitoring function. When enabled and the case is opened, the speaker beeps.

CPU Warning Temperature

Use this to set the CPU warning temperature threshold. When the system reaches the warning temperature, the speaker will beep.

ACPI Shutdown Temperature

Use this to set the ACPI shutdown temperature threshold. When the system reaches the shutdown temperature, it will be automatically shut down by ACPI OS to protect the system from overheat damage.

CPUFAN Mode Setting

“Enable or Disable” CPUFAN Mode to SMART FAN setting

3.3.10 F81216 Super IO Configuration

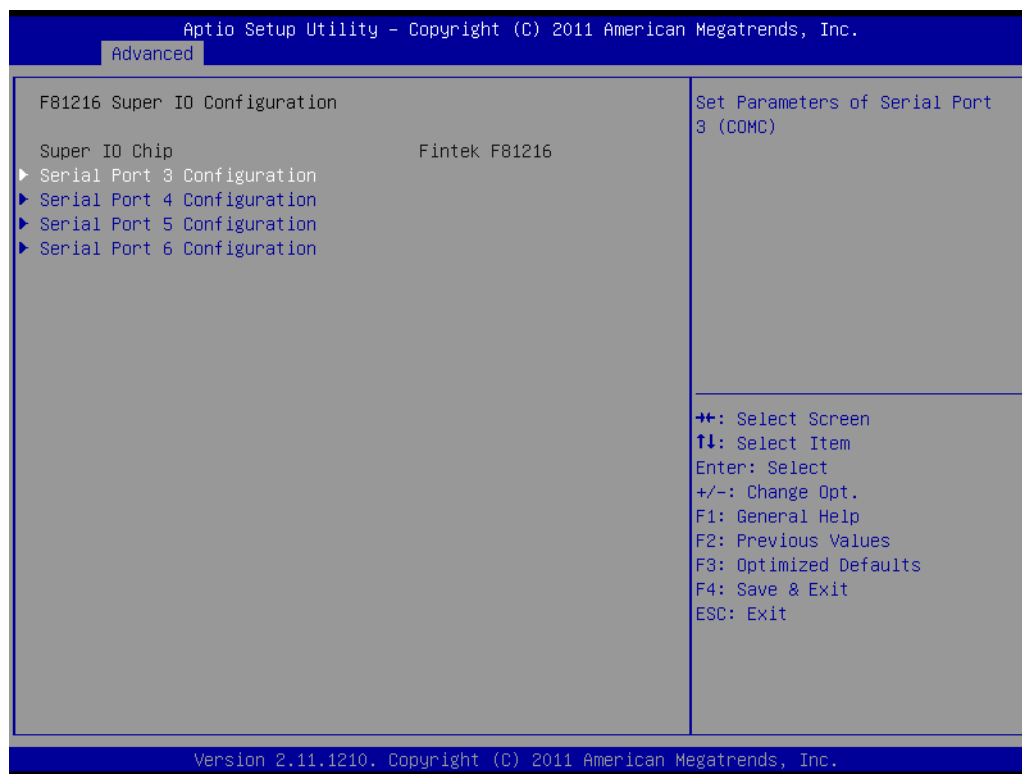

Figure 3.17 F81216 Super IO Configuration

AIMB-781QG2 version supports 2nd super IO for Com 3~6, so this page of bios menu is to set respective serial port configuration.

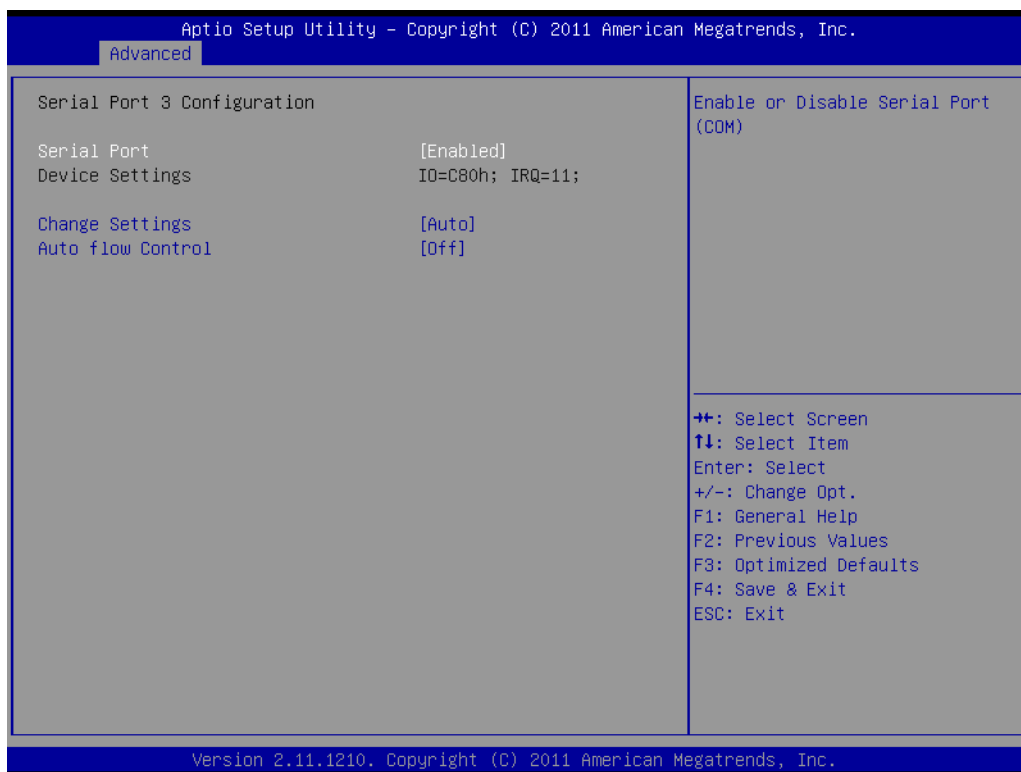

Figure 3.18 Serial Port 3 Configuration

Serial Port 3 Configuration

Serial Port

To “enable or disable” Serial Port 3.

Change Settings

To select an optimal setting for serial port 3.

Auto flow control

When com is to set as RS-422, it could support auto flow control function, so this item is able to “Enable or Disable” auto flow control function.

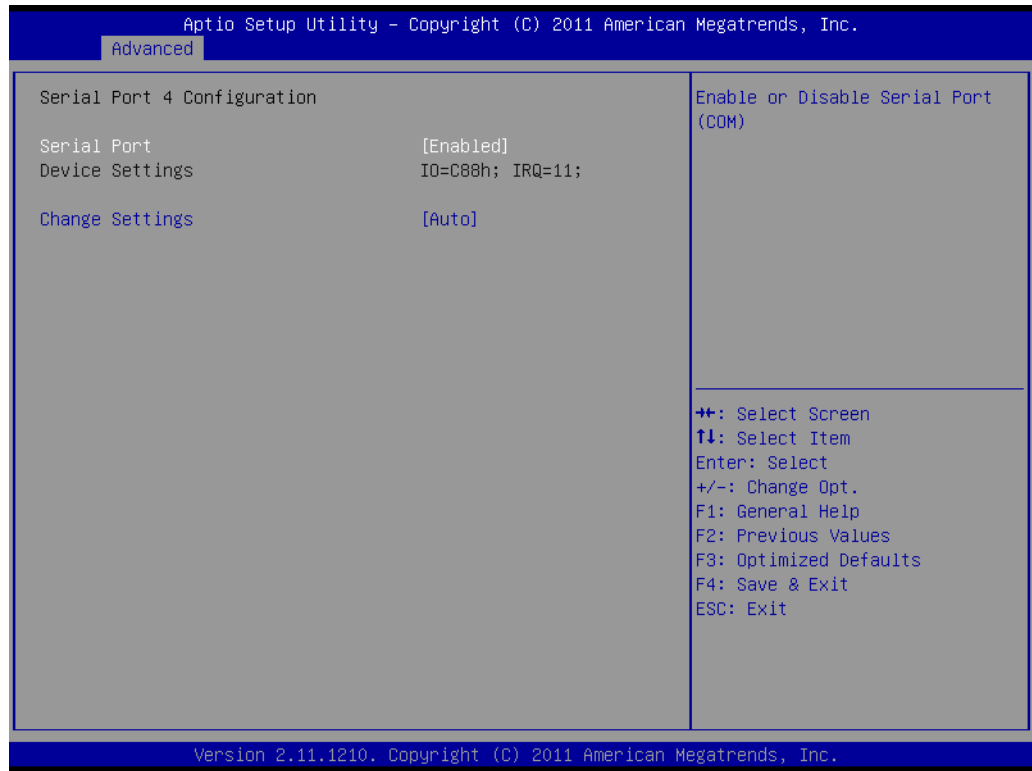

Figure 3.19 Serial Port 4 Configuration

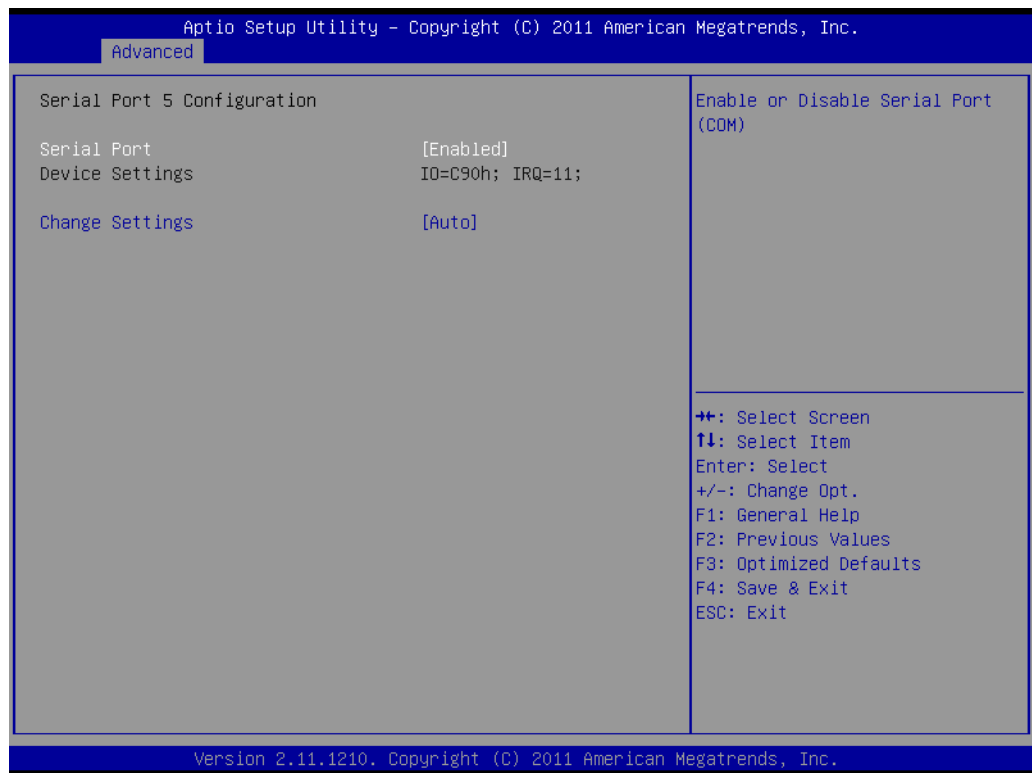

Figure 3.20 Serial Port 5 Configuration

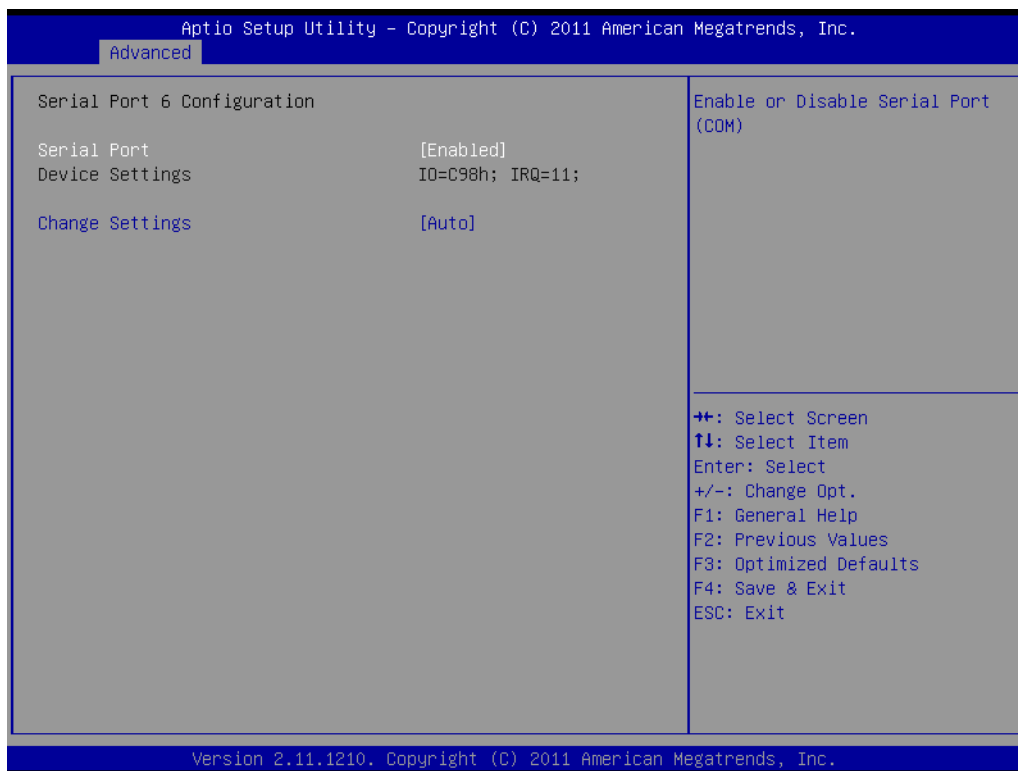

Figure 3.21 Serial Port 6 Configuration

Serial Port 4 configuration

Serial Port

To “enable” or “disable” Serial Port 4.

Change Settings

To select an optimal setting for serial port 4.

Serial Port 5 configuration

Serial Port

To “enable” or “disable” Serial Port 5.

Change Settings

To select an optimal setting for serial port 5.

Serial Port 6 configuration

Serial Port

To “enable” or “disable” Serial Port 6.

Change Settings

To select an optimal setting for serial port 6.

3.3.11 AMT Configuration

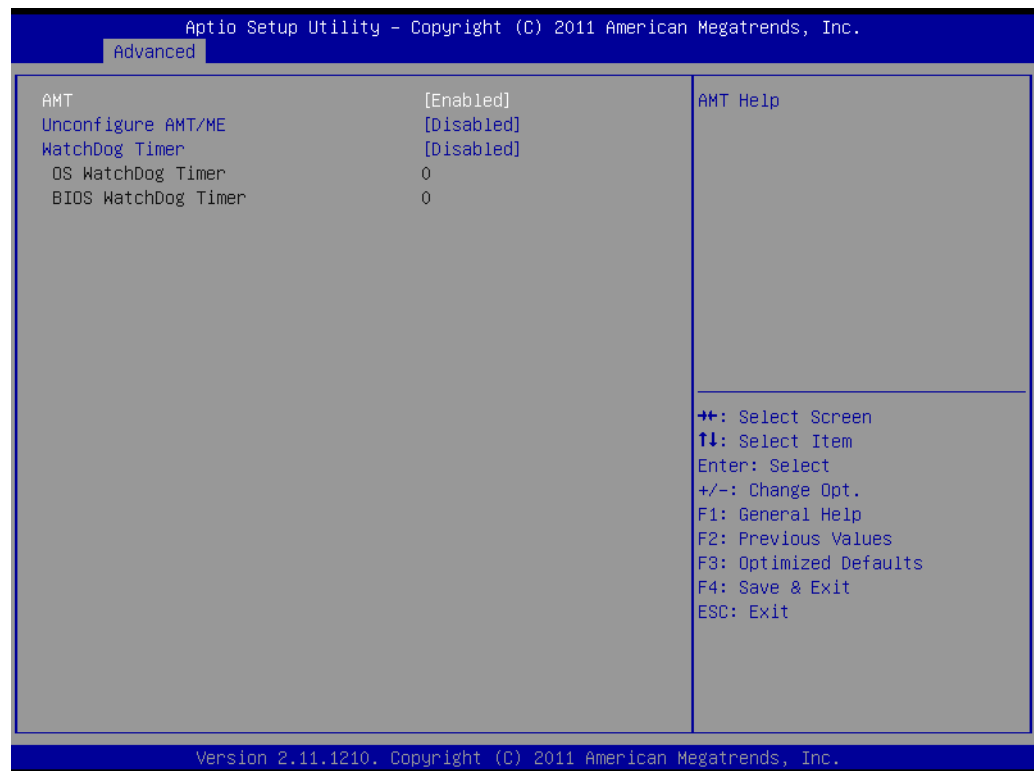

Figure 3.22 AMTConfiguration

AMT

“Enable or Disable” Intel Advance Management Technology

Unconfigure AMT/ME

“Enable or Disable” Unconfigure AMT/ME

WatchDog Timer

“Enable or Disable” Watchdog Timer

3.3.12 Serial Port Console Redirection

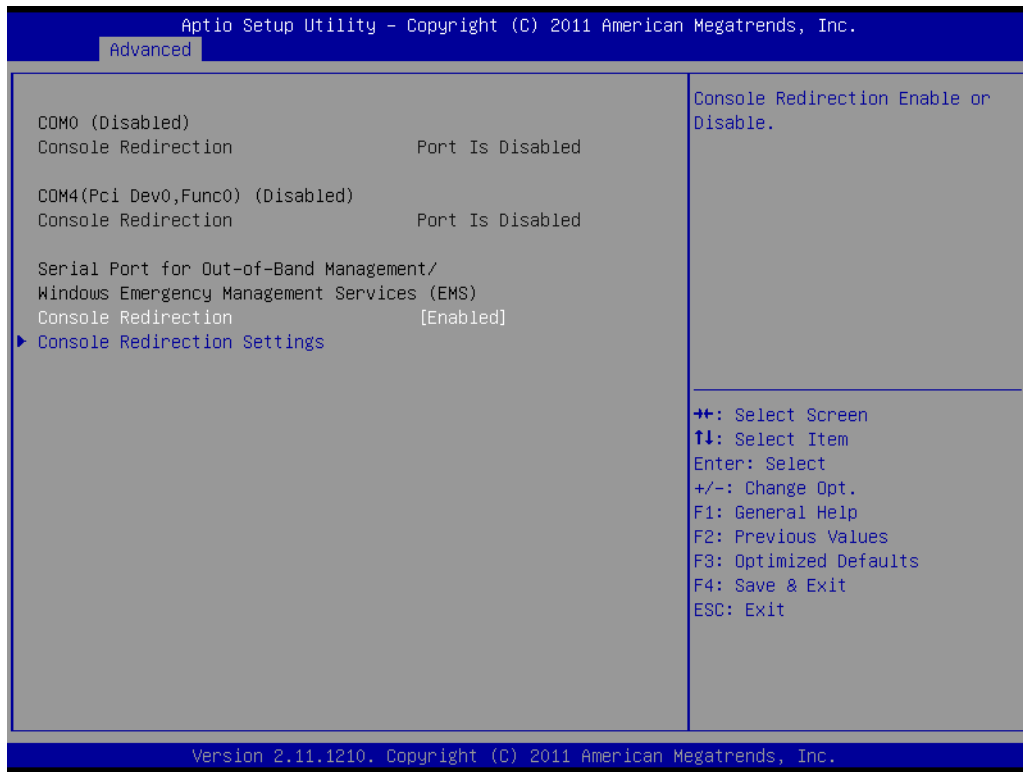
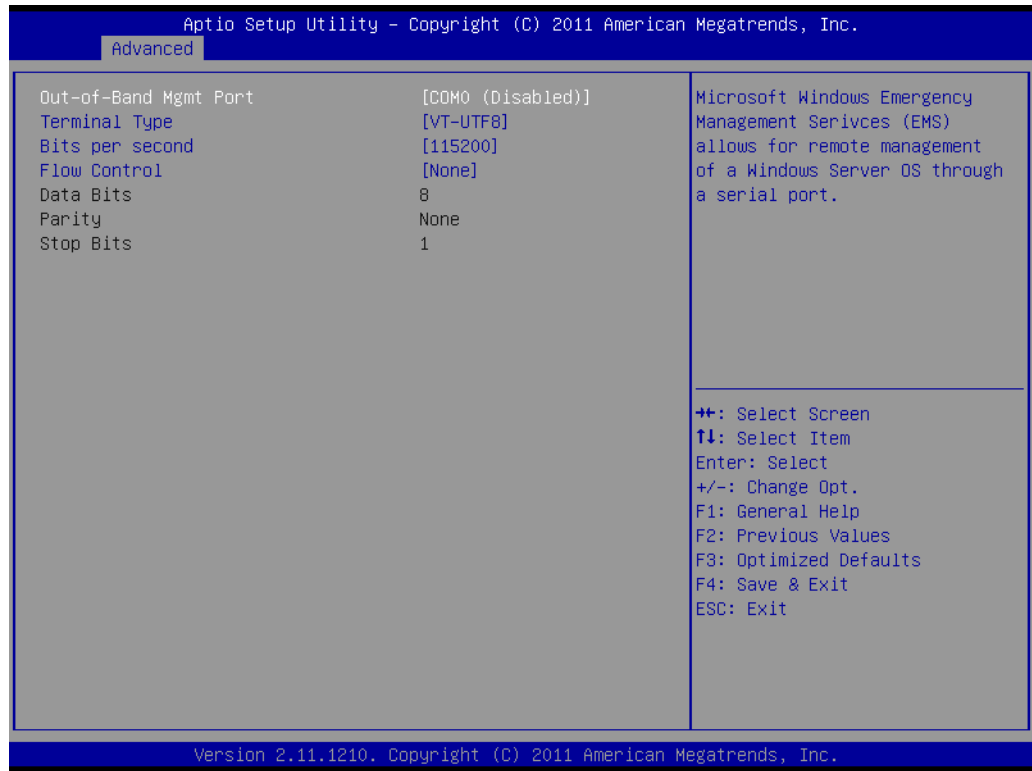

Figure 3.23 Serial Port Console Redirection

Console Redirection

To “Enable or disable” console redirection feature



Console Redirection Setting

Out-of-Band Mgmt Port

To select the com port user would like to set for having console redirection feature.

Terminal Type

It could be set as "VT100", "VT100+", "VT-UTF8", or "ANSI", and "VT-UTF8" is the default setting.

Bits per second

To select serial port transmission, and the speed must be matched on the other side. It could be set as "9600", "19200", "57600", or "115200", and "115200" is the default setting.

Flow Control

Flow control can prevent data loss from buffer overflow, and it could set as "None", "Hardware RTS/CTS", or "Software Xon/Xoff", and "None" is the default setting.

3.4 Chipset

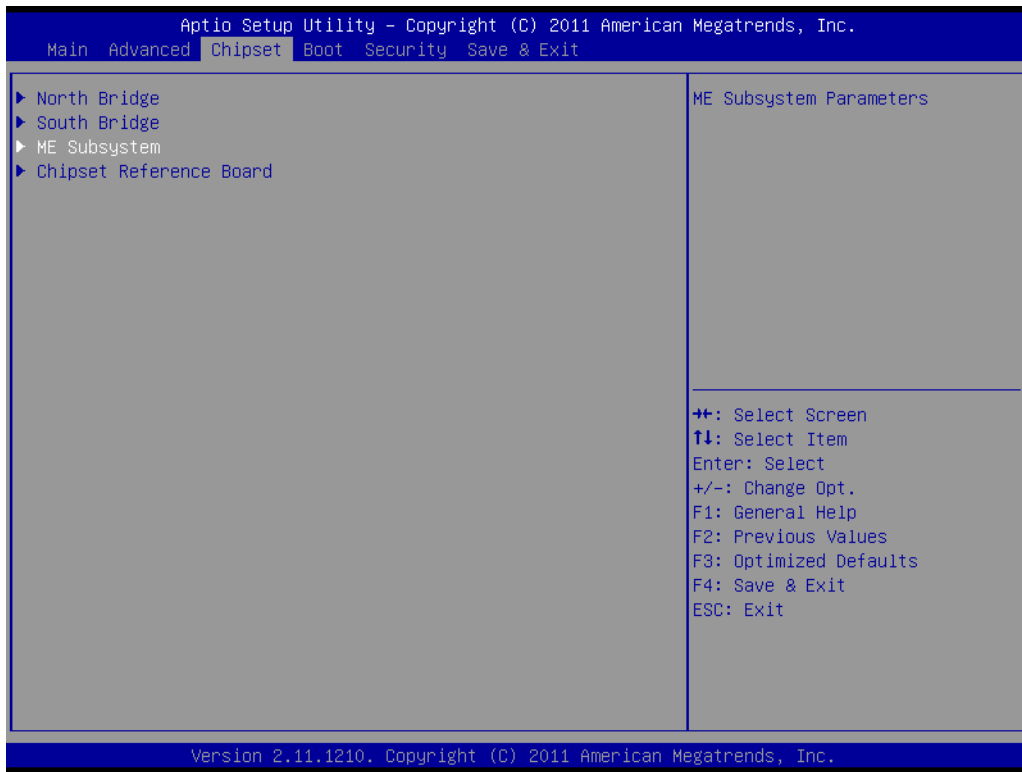

Figure 3.24 Chipset

3.4.1 North Bridge

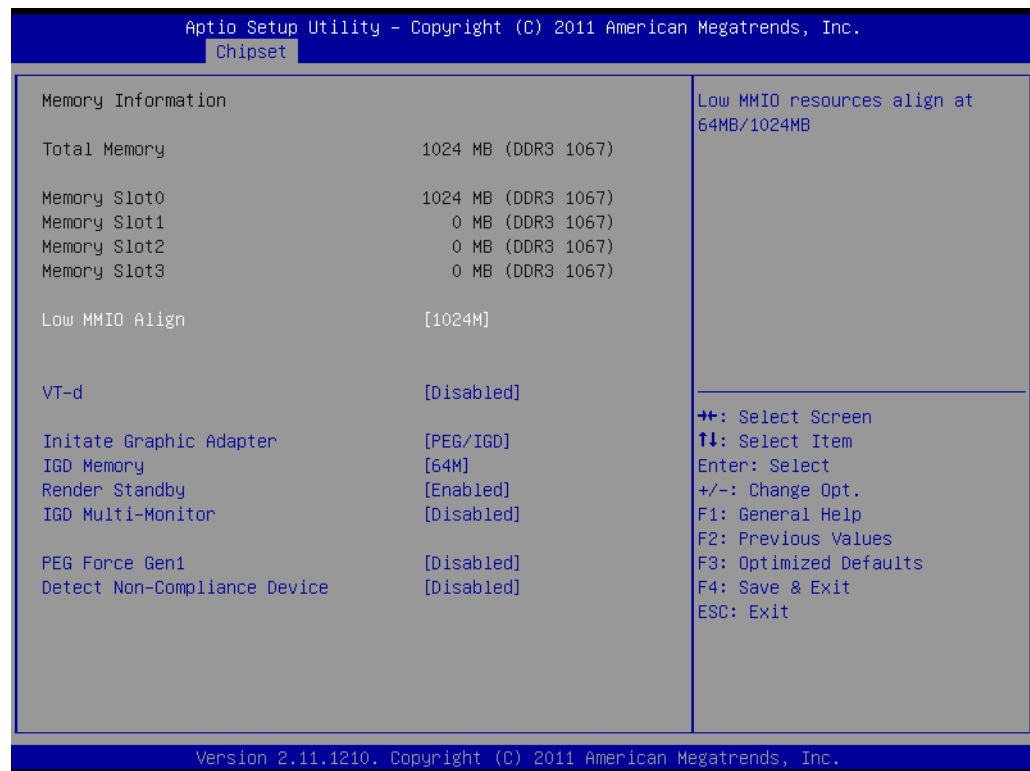

Figure 3.25 North Bridge

Low MMIO Align

Low MMIO resources align at 64MB/1024MB.

VT-d

To support Intel chipset virtualization technology for directed I/O.

Initiate Graphic Adapter

This setting allows user to select which graphics controller to be the primary graphic device when booting up.

IGD Memory

Allows user to select integrate graphic memory.

Render Standby

“Enable, Disable” Render Standby by Internal Graphics Device

IGD Multi-Monitor

“Enable, Disable” IGD Multi-monitor by Internal Graphics Internal Device

PEG Force Gen1

Allows user to force PEG port downgrade to Gen1.

Detect Non-Compliance Device

“Enable, Disable” Detect Non-Compliance Device

3.4.2 South Bridge

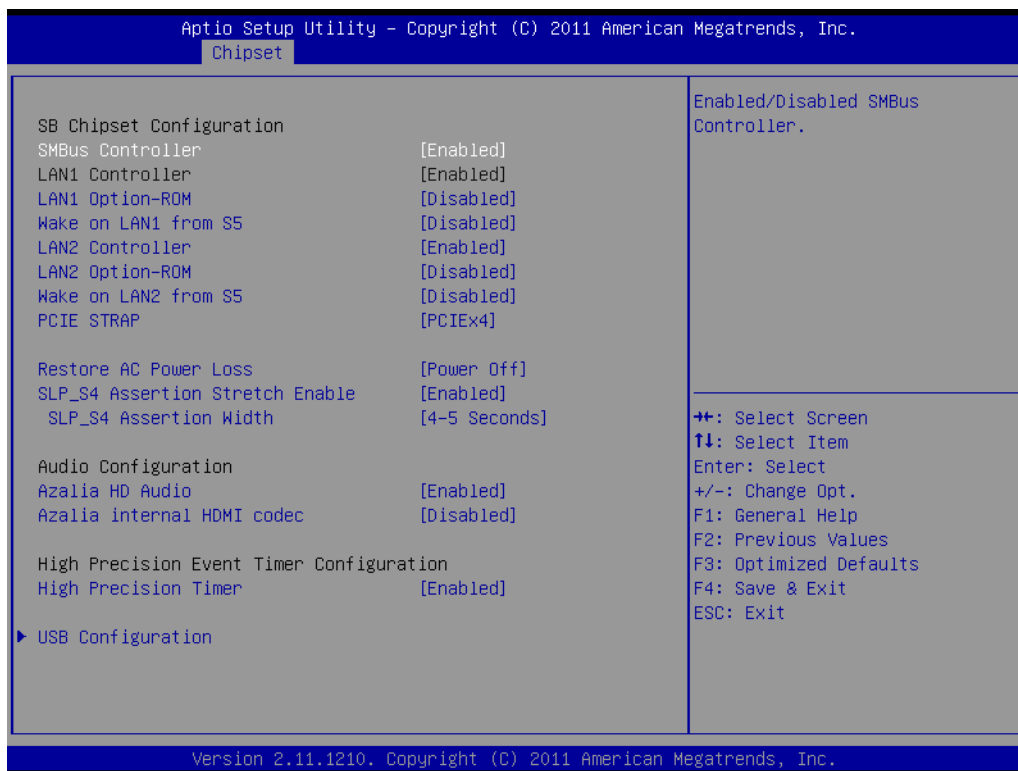

Figure 3.26 South Bridge

SMBus Controller

"Enable or Disable" SMBus Controller.

LAN2 Controller

"Enable or Disable" LAN2 Controller.

LAN Option-ROM

"Enable or Disable" LAN Option-ROM.

Wake on LAN from S5

"Enable or Disable" Wake on LAN from S5.

PCIE STRAP

It could be set as "PCIE x4" or "4 PCIE x". When using Advantech x4 to 3 x1 riser card, this item should be set as "4 PCIE x1".

High Precision Timer

"Enable or Disable" High Precision Event Timer.

Deep S5

"Enable or Disable" Deep S5 feature. When Deep S5 is enabled, most power, including 5VSB, will be off during Deep S5 for energy savings.

Note!



When a system enters G3 status with deep S5 enabled, some power supply's 5VSB won't drop until after more than 30 seconds. If "Restore AC Power Loss" is set to "power on", the system won't boot up in 30 seconds after power failure. We recommend the user wait for more than 30 seconds to power on after a power failure. On the other hand, system will auto power on if power is restored within 30 seconds, before 5VSB actually drops, even if "Restore AC Power Loss" is set to "power off".

3.4.3 USB Configuration

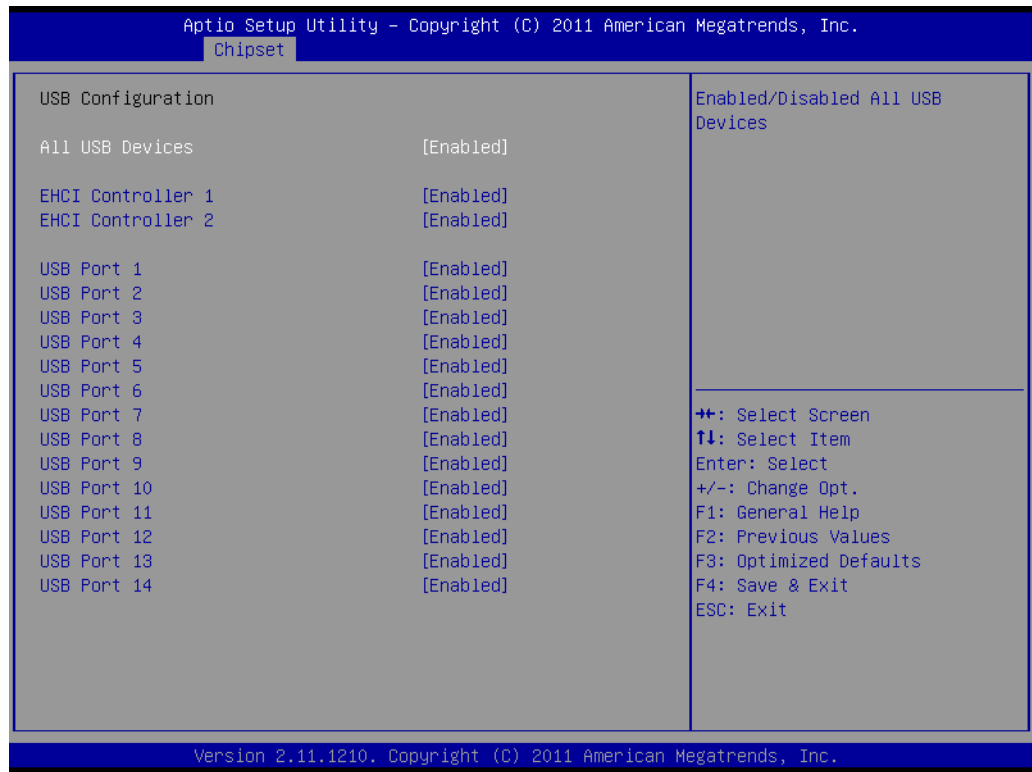

Figure 3.27 USB Configuration

All USB Devices

“Enable or Disable” All USB Devices.

EHCI Controller 1 & 2

“Enable or Disable” EHCI Controller 1 or 2.

USB Port 1~14

“Enable or Disable” USB Port 1~14.

3.4.4 ME Subsystem

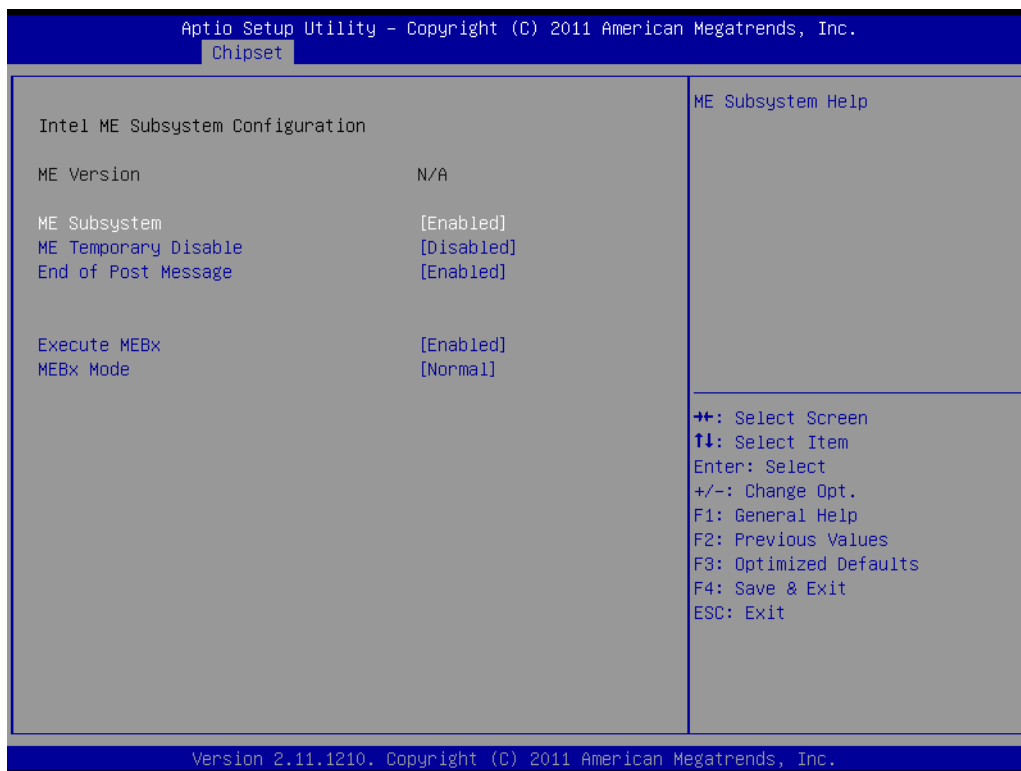

Figure 3.28 ME Subsystem

ME Subsystem

“Enable or Disable” Intel Management Engine Subsystem.

ME Temporary Disable

“Enable or Disable” ME Temporary Disable

End of Post Message

“Enable or Disable” End of Post Message.

Execute MEBx

“Enable or Disable” Execute MEBx to show “Ctrl+P” to enter ME setup during post screen

MEBx Mode

“Normal, Hidden Ctrl+P, Enter MEBx Setup” to use ME setup

3.5 Boot

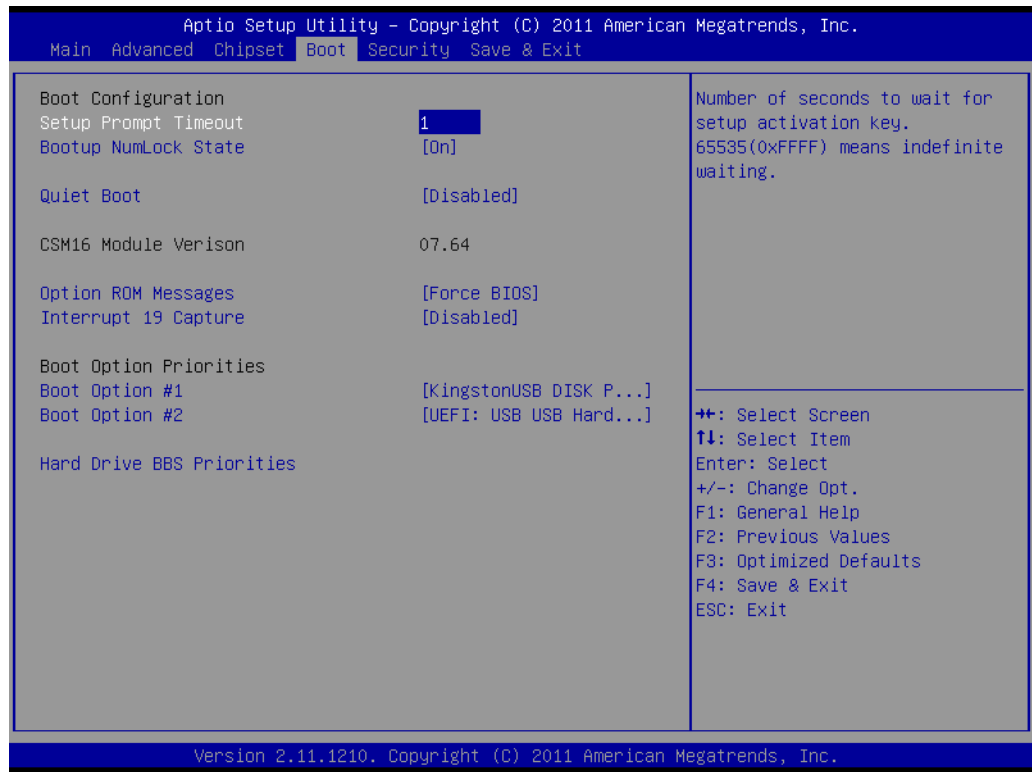

Figure 3.29 Boot

Setup Prompt Timeout

Use the <+> and <-> keys to adjust the number of seconds to wait for setup activation key.

Bootup NumLock State

“On or Off” power-on state for the NumLock

Quiet Boot

If this option is set to Disabled, the BIOS displays normal POST messages. If Enabled, an OEM Logo is shown instead of POST messages.

Option ROM Messages

“Force BIOS or Keep Current” to set the display mode for Option ROM

Interrupt 19 Capture

“Enable or Disable” Option ROM to trap Interrupt 19

Boot Option #1/#2

Choose boot priority from boot device

3.6 Security

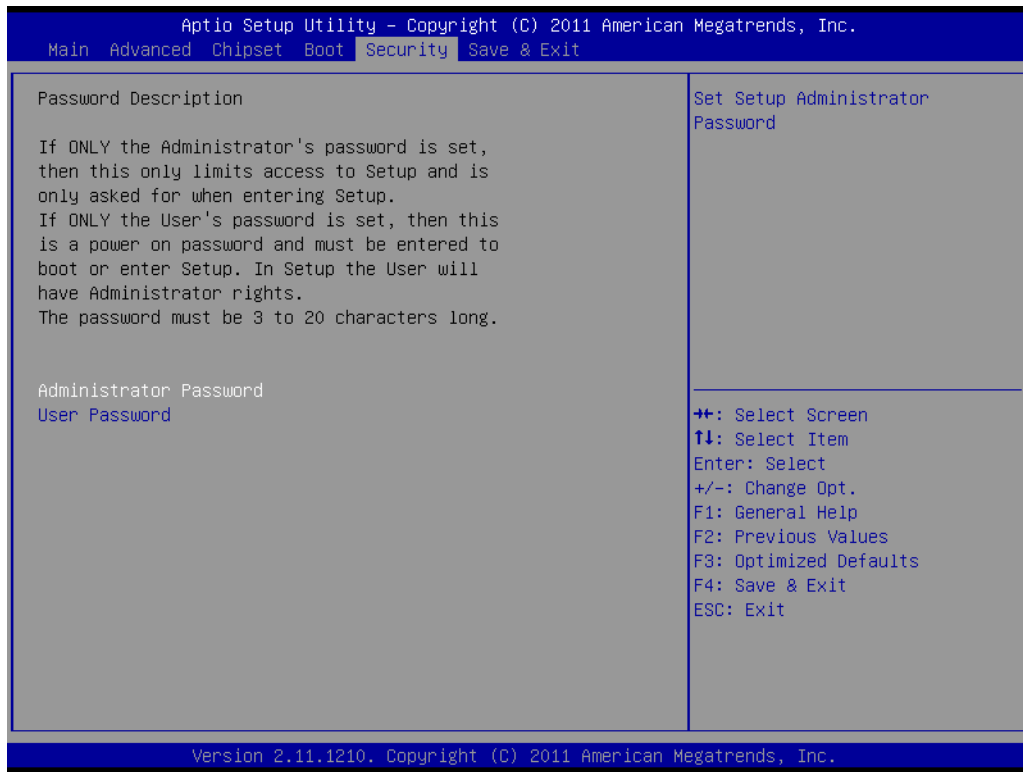

Figure 3.30 Security

Select Security Setup from the AIMB-781 Setup main BIOS setup menu. All Security Setup options, such as password protection is described in this section. To access the sub menu for the following items, select the item and press <Enter>.

3.7 Save & Exit

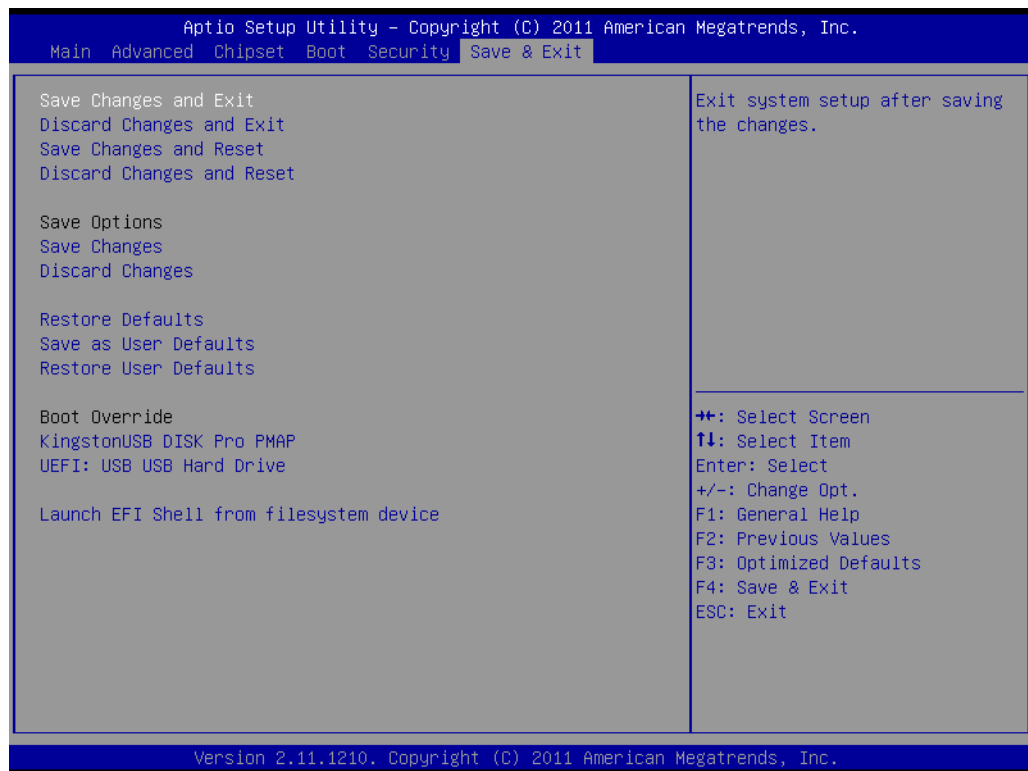

Figure 3.31 Save & Exit

Save changes and exit

When you have completed system configuration, select this option to save your changes, exit BIOS setup and reboot the computer so the new system configuration parameters can take effect.

1. Select Exit Saving Changes from the Exit menu and press <Enter>. The following message appears:
Save Configuration Changes and Exit Now?
[Yes] [No]
2. Select Yes or No.

Discard changes and exit

Select this option to quit Setup without making any permanent changes to the system configuration.

1. Select Exit Discarding Changes from the Exit menu and press <Enter>. The following message appears:
Quit without saving?
[Yes] [No]
2. Select Yes to discard changes and exit.

Discard Changes

Select Discard Changes from the Exit menu and press <Enter>.

Chapter 4

Chipset Software
Installation Utility

4.1 Before you begin

To facilitate the installation of the enhanced display drivers and utility software, read the instructions in this chapter carefully. The drivers for the AIMB-781 are located on the software installation CD.

Note! *The files on the software installation CD are compressed. Do not attempt to install the drivers by copying the files manually. You must use the supplied SETUP program to install the drivers.*



Before you begin, it is important to note that most display drivers need to have the relevant software application already installed in the system prior to installing the enhanced display drivers. In addition, many of the installation procedures assume that you are familiar with both the relevant software applications and operating system commands. Review the relevant operating system commands and the pertinent sections of your application software's user manual before performing the installation.

4.2 Introduction

The Intel Chipset Software Installation (CSI) utility installs the Windows INF files that outline to the operating system how the chipset components will be configured. This is needed for the proper functioning of the following features:

- Core PCI PnP services
- Serial ATA interface support
- USB 1.1/2.0 support (USB 2.0 driver needs to be installed separately for Windows 98)
- Identification of Intel chipset components in the Device Manager

Note! *The chipset driver is used for the following versions of Windows, and it has to be installed before installing all the other drivers:*



- Windows 7 (32-bit)
- Windows 7 (64-bit)
- Windows XP professional edition (32-bit)
- Windows XP professional edition (64-bit)

4.3 Windows XP / Windows 7 Driver Setup

1. Insert the driver CD into your system's CD-ROM drive. You can see the driver folders items. Move the mouse cursor over the folder "01-Chipset". In CSI folder, you can click find an executable file to complete the implement of the driver

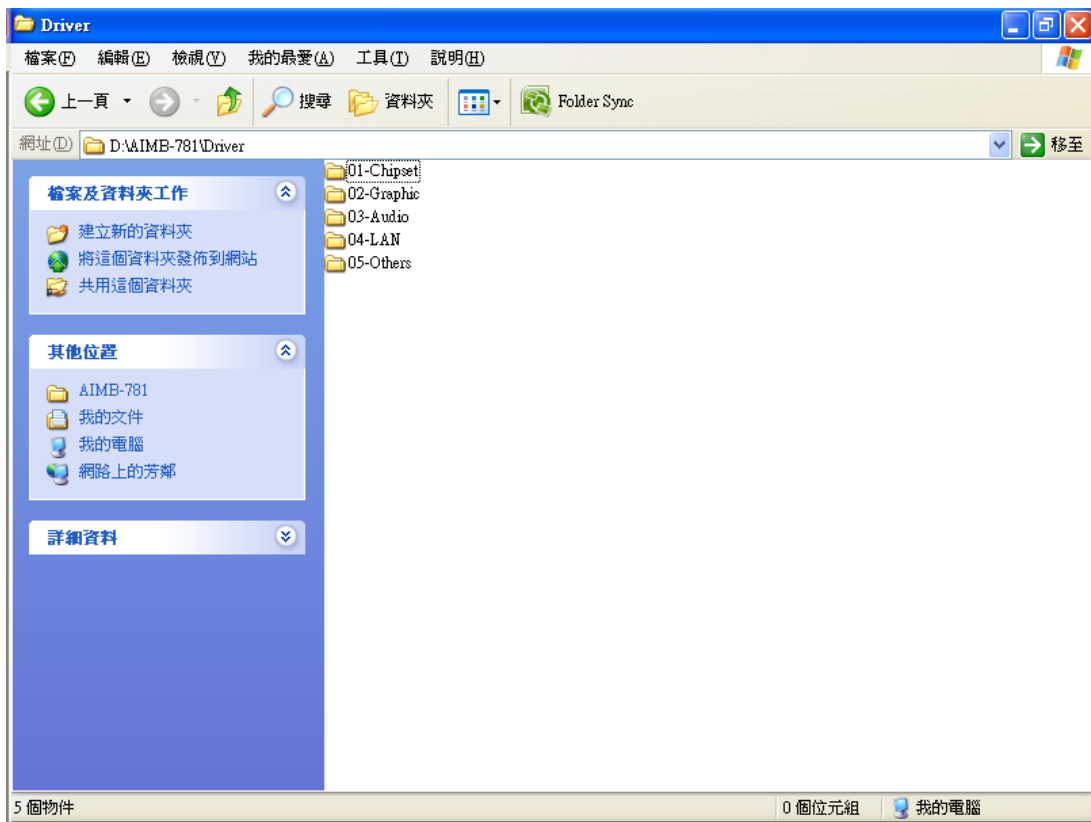

2. Click setup to execute program.

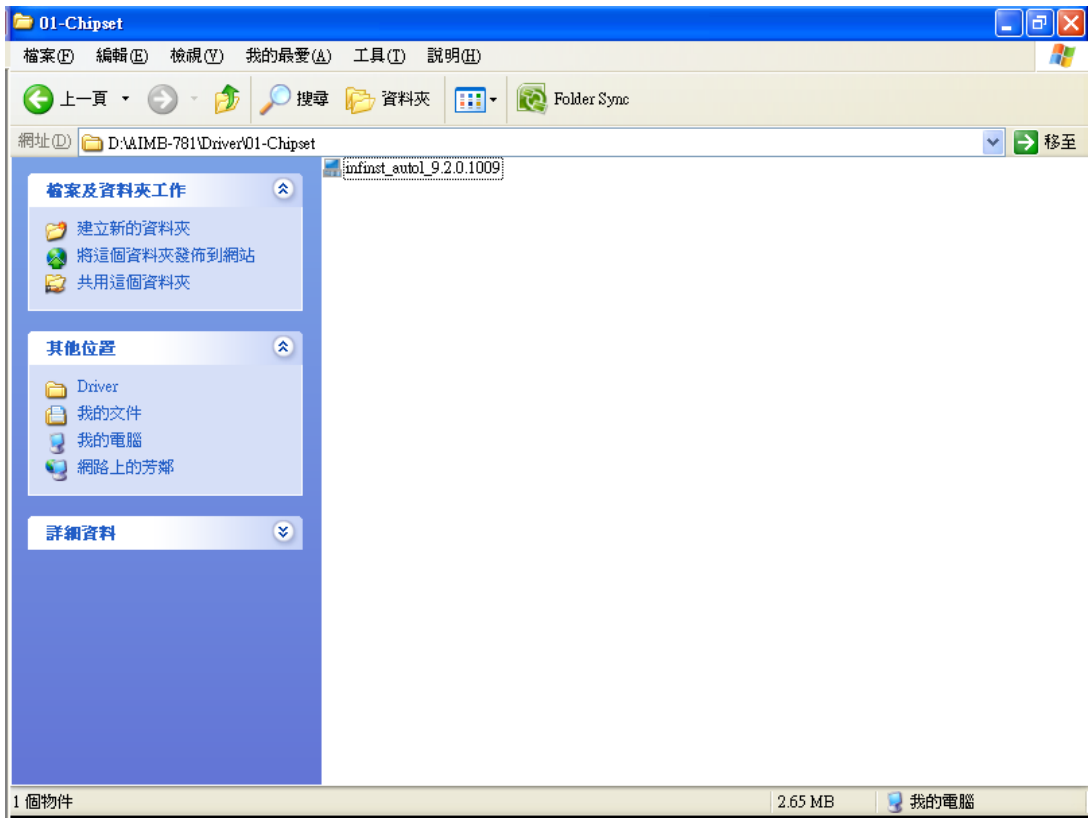

Chapter 5

VGA Setup

5.1 Introduction

The 2nd Gen Intel Core i processors are embedded with integrated graphics controller. You need to install the VGA driver to enable this function, which includes the following features:

- Optimized integrated graphic solution: With Intel Graphics Flexible Display Interface, it supports versatile display options and 32-bit 3D graphics engine. Dual independent display, enhanced display modes for widescreen flat panels for extend, twin, and clone dual display mode, and optimized 3D support deliver an intensive and realistic visual experience.

5.2 Windows XP/Windows 7 Driver Setup

Note! Before installing this driver, make sure the INF driver has been installed in your system. See Chapter 4 for information on installing the INF driver.



Insert the driver CD into your system's CD-ROM drive. You can see the driver folders items. Navigate to the "02-Graphic" folder and click the executable file to complete the installation of the drivers for Windows 7, XP.

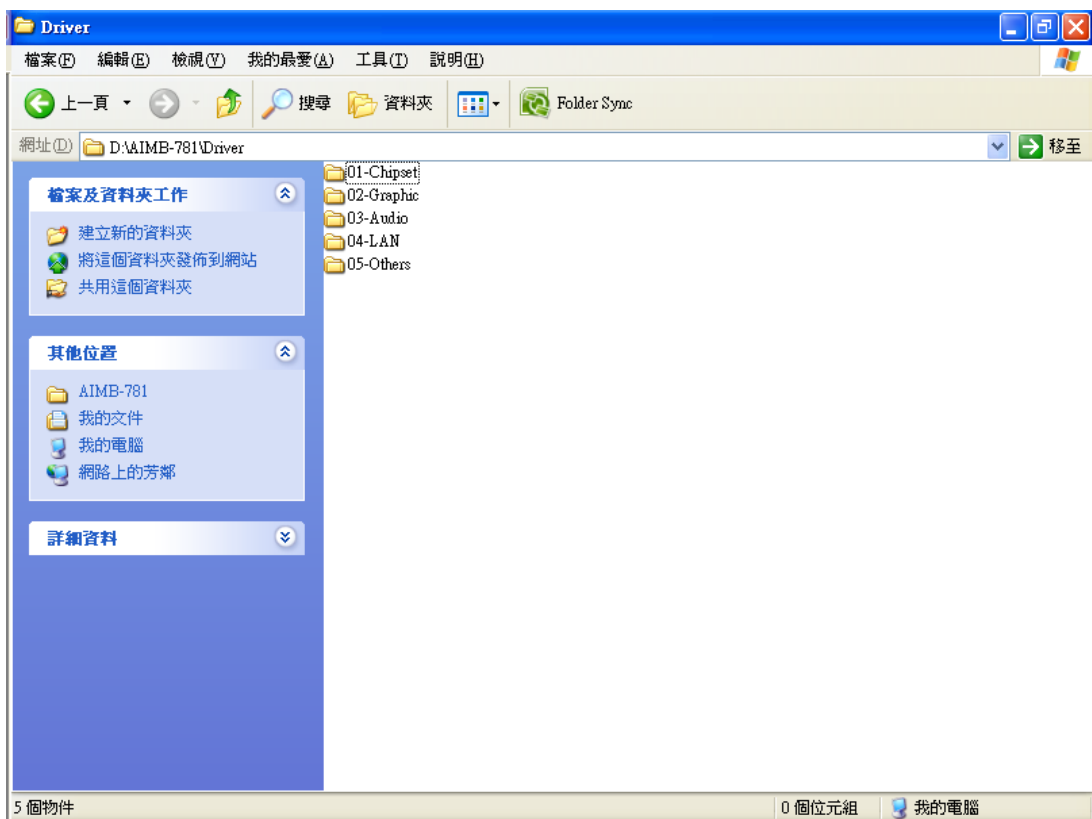

Chapter 6

LAN Configuration

6.1 Introduction

The AIMB-781 has dual Gigabit Ethernet LANs via dedicated PCI Express x1 lanes (Intel 82579LM (LAN1) and 82583V (LAN2)) that offer bandwidth of up to 500 MB/sec, eliminating the bottleneck of network data flow and incorporating Gigabit Ethernet at 1000 Mbps.

6.2 Features

- 10/100/1000Base-T Ethernet controller
- 10/100/1000Base-T triple-speed MAC
- Full duplex at 10, 100, or 1000 Mbps and half duplex at 10 or 100 Mbps
- Wake-on-LAN (WOL) support
- PCIe x1 host interface

6.3 Installation

Note! Before installing the LAN drivers, make sure the CSI utility have been installed on your system. See Chapter 4 for information on installing the CSI utility.



The integrated Intel gigabit Ethernet controller supports all major network operating systems. However, the installation procedure varies with different operating systems. In the following sections, refer to the one that provides the driver setup procedure for the operating system you are using.

6.4 Win XP /Win 7 Driver Setup (LAN)

Insert the driver CD into your system's CD-ROM drive. Select folder "04-LAN" then click the proper Lan driver for the OS.

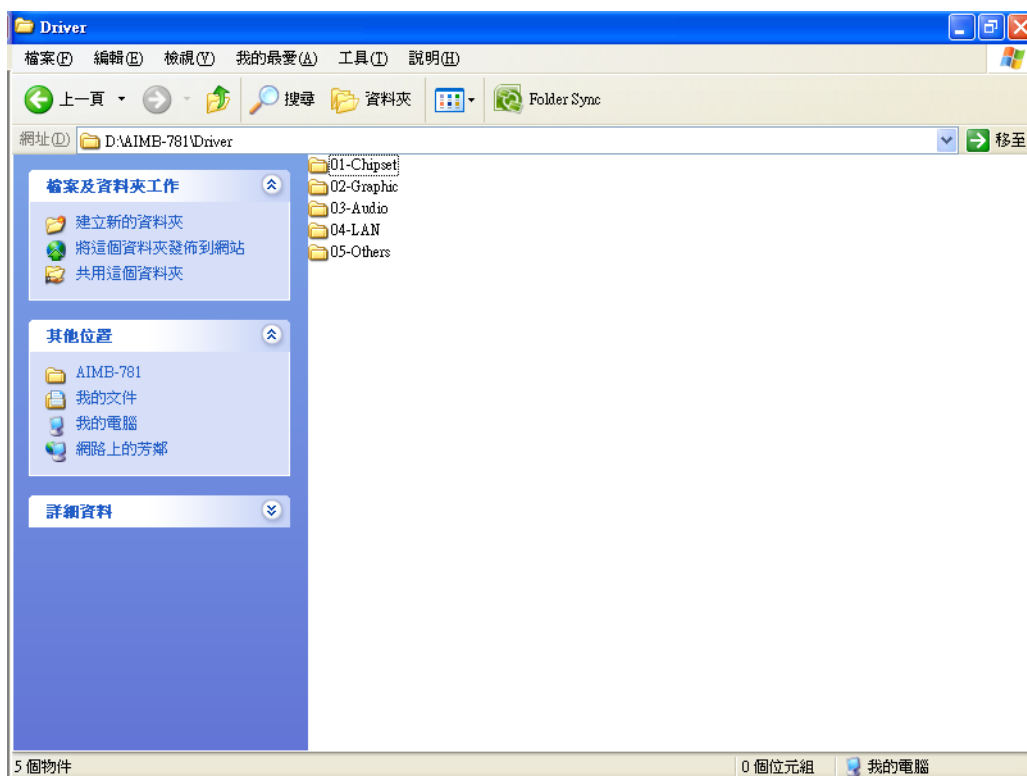

Appendix **A**

Programming the
Watchdog Timer

The AIMB-781's watchdog timer can be used to monitor system software operation and take corrective action if the software fails to function within the programmed period. This section describes the operation of the watchdog timer and how to program it.

A.1 Watchdog timer overview

The watchdog timer is built in to the super I/O controller NCT6776F. It provides the following functions for user programming:

- Can be enabled and disabled by user's program
- Timer can be set from 1 to 255 seconds or 1 to 255 minutes
- Generates an interrupt or resets signal if the software fails to reset the timer before time-out

A.2 Programming the Watchdog Timer

The I/O port address of the watchdog timer is 2E (hex) and 2F (hex). 2E (hex) is the address port. 2F (hex) is the data port. You must first write an address value into address port 2E (hex), and then write/read data to/from the assigned register through data port 2F (hex).

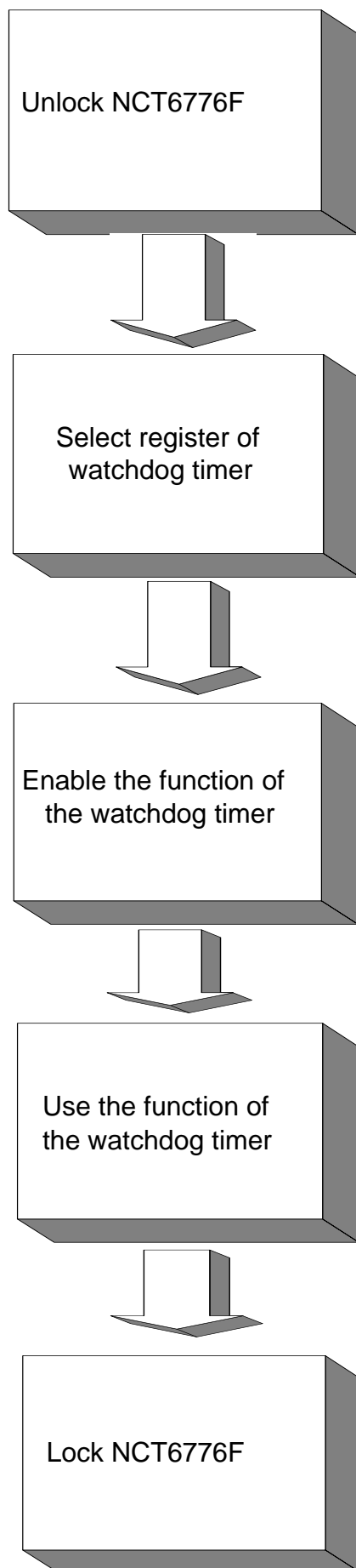

Table A.1: Watchdog timer registers

Address of register (2E)	Read/Write	Value (2F) & description
87 (hex)	-	Write this address to I/O address port 2E (hex) twice to unlock the NCT6776F
07 (hex)	write	Write 08 (hex) to select register of watchdog timer.
30 (hex)	write	Write 01 (hex) to enable the function of the watchdog timer. Disabled is set as default.
F5 (hex)	write	Set seconds or minutes as units for the timer. Write 0 to bit 3: set seconds as counting unit. [default]. Write 1 to bit 3: set minutes as counting unit. Write 1 to bit 4: Watchdog timer count mode is 1000 times faster. If bit 3 is 0, the count mode is 1/1000 seconds mode. If bit 3 is 1, the count mode is 1/1000 minutes mode.
F6 (hex)	write	0: stop timer [default] 01 ~ FF (hex): The amount of the count, in seconds or minutes, depends on the value set in register F5 (hex). This number decides how long the watchdog timer waits for strobe before generating an interrupt or reset signal. Writing a new value to this register can reset the timer to count with the new value.
F7 (hex)	read/write	Bit 6: Write 1 to enable keyboard to reset the timer, 0 to disable.[default] Bit 5: Write 1 to generate a timeout signal immediately and automatically return to 0. [default=0] Bit 4: Read status of watchdog timer, 1 means timer is "timeout".
AA (hex)	-	Write this address to I/O port 2E (hex) to lock NCT6776F.

A.2.1 Example Programs

Enable watchdog timer and set 10 seconds as the timeout interval

```

;-----
Mov dx,2eh ; Unlock NCT6776F
Mov al,87h
Out dx,al
Out dx,al
;-----
Mov al,07h ; Select registers of watchdog timer
Out dx,al
Inc dx
in al,dx
Or al,08h
Out dx,al
;-----
Dec dx; Enable the function of watchdog timer
Mov al,30h
Out dx,al
Inc dx
Mov al,01h
Out dx,al
;-----

```

```

Dec dx ; Set second as counting unit
Mov al,0f5h
Out dx,al
Inc dx
In al,dx
And al,not 08h
Out dx,al
;-----
Dec dx ; Set timeout interval as 10 seconds and start counting
Mov al,0f6h
Out dx,al
Inc dx
Mov al,10; 10 minutes
Out dx,al
;-----
Dec dx ; lock NCT6776F
Mov al,0aah
Out dx,al
Enable watchdog timer and set 5 minutes as the timeout interval
;-----
Mov dx,2eh ; unlock NCT6776F
Mov al,87h
Out dx,al
Out dx,al
;-----
Mov al,07h ; Select registers of watchdog timer
Out dx,al
Inc dx
In al,dx
Or al,08h
Out dx,al
;-----
Dec dx ; Enable the function of watchdog timer
Mov al,30h
Out dx,al
Inc dx
Mov al,01h
Out dx,al
;-----
Dec dx ; Set minute as counting unit
Mov al,0f5h
Out dx, al
Inc dx
In al,dx
Or al, 08h

```

```

Out dx,al
;-----
Dec dx ; Set timeout interval as 5 minutes and start counting
Mov al,0f6h
Out dx,al
Inc dx
Mov al,5; 5 minutes
Out dx,al
;-----
Dec dx ; lock NCT6776F
Mov al,0aah
Out dx,al
Enable watchdog timer to be reset by mouse
;-----
Mov dx,2eh ; unlock NCT6776F
Mov al,87h
Out dx,al
Out dx,al
;-----
Mov al,07h ; Select registers of watchdog timer
Out dx,al
Inc dx
Mov al,08h
Out dx,al
;-----
Dec dx ; Enable the function of watchdog timer
Mov al,30h
Out dx,al
Inc dx
In al,dx
Or al,01h
Out dx,al
;-----
Dec dx ; Enable watchdog timer to be reset by mouse
Mov al,0f7h
Out dx,al
Inc dx
In al,dx
Or al,80h
Out dx,al
;-----
Dec dx ; lock NCT6776F
Mov al,0aah
Out dx,al
Enable watchdog timer to be reset by keyboard

```

```

;-----
Mov dx,2eh ; unlock NCT6776F
Mov al,87h
Out dx,al
Out dx,al
;-----
Mov al,07h ; Select registers of watchdog timer
Out dx,al
Inc dx
Mov al,08h
Out dx,al
;-----
Dec dx ; Enable the function of watchdog timer
Mov al,30h
Out dx,al
Inc dx
Mov al,01h
Out dx,al
;-----
Dec dx ; Enable watchdog timer to be strobed reset by keyboard
Mov al,0f7h
Out dx,al
Inc dx
In al,dx
Or al,40h
Out dx,al
;-----
Dec dx ; lock NCT6776F
Mov al,0aah
Out dx,al
Generate a time-out signal without timer counting
;-----
Mov dx,2eh ; unlock NCT6776F
Mov al,87h
Out dx,al
Out dx,al
;-----
Mov al,07h ; Select registers of watchdog timer
Out dx,al
Inc dx
Mov al,08h
Out dx,al
;-----
Dec dx ; Enable the function of watchdog timer
Mov al,30h

```

```
Out dx,al
Inc dx
In al,dx
Or al,01h
Out dx,al
;-----
Dec dx ; Generate a time-out signal
Mov al,0f7h
Out dx,al ;Write 1 to bit 5 of F7 register
Inc dx
In al,dx
Or al,20h
Out dx,al
;-----
Dec dx ; lock NCT6776F
Mov al,0aah
Out dx,al
```

Appendix **B**

I/O Pin Assignments

B.1 Parallel Port (LPT1)

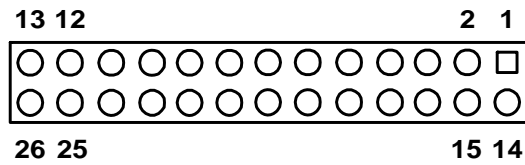

Table B.1: Parallel Port (LPT1)

Pin	Signal	Pin	Signal
1	STROBE*	14	AUTOFD*
2	D0	15	ERR*
3	D1	16	INIT*
4	D2	17	SLCTINI*
5	D3	18	GND
6	D4	19	GND
7	D5	20	GND
8	D6	21	GND
9	D7	22	GND
10	ACK*	23	GND
11	BUSY	24	GND
12	PE	25	GND
13	SLCT	26	N/C

B.2 USB Header (USB56, USB78, USB910, USB1112 & USB1314)

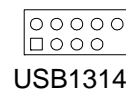
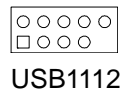
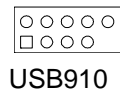
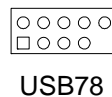
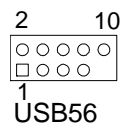

Table B.2: USB Header (USB56,USB78,USB910,USB1112,USB1314)

Pin	Signal	Pin	Signal
1	USB_VCC5	2	USB_VCC5
3	USB_D-	4	USB_D-
5	USB_D+	6	USB_D+
7	GND	8	GND
9	Key	10	N/C

B.3 VGA Connector (VGA1)

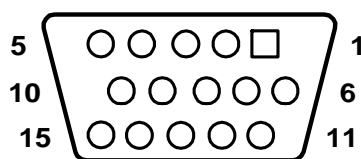

Table B.3: VGA Connector (VGA1)

Pin	Signal	Pin	Signal
1	RED	9	VCC
2	GREEN	10	GND
3	BLUE	11	N/C
4	N/C	12	SDT
5	GND	13	H-SYNC
6	GND	14	V-SYNC
7	GND	15	SCK
8	GND		

B.4 RS-232 Interface (COM3~6)

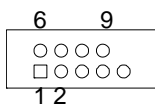

Table B.4: RS-232 Interface (COM1)

Pin	Signal
1	DCD
2	RXD
3	TXD
4	DTR
5	GND
6	DSR
7	RTS
8	CTS
9	RI

B.5 PS/2 Keyboard and Mouse Connector (KBMS1)

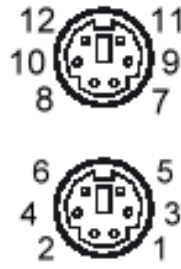

Table B.5: Keyboard and Mouse Connector (KBMS1)

Pin	Signal
1	KB DATA
2	N/C
3	GND
4	KB VCC
5	KB CLK
6	N/C
7	M_DATA
8	N/C
9	GND
10	M_VCC
11	M_CLK
12	N/C

B.6 External Keyboard Connector (KBMS2)

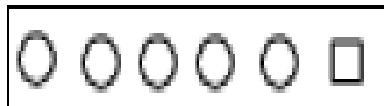

Table B.6: External Keyboard Connector (KBMS2)

Pin	Signal
1	KB CLK
2	KB DATA
3	MS DATA
4	GND
5	VCC
6	MS CLK

B.7 Infrared (IR) connector (JIR1)

Table B.7: Infrared Connector (JIR1)

Pin	Signal
1	+5 V
2	N/C
3	IRRX
4	GND
5	IRTX

B.8 System Fan Power Connector (SYSFAN1/SYSFAN2)

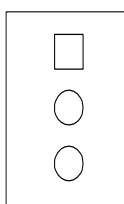

Table B.8: Fan Power Connector (SYSFAN1/SYSFAN2)

Pin	Signal
1	GND
2	+12 V
3	DETECT
4	PWM

B.9 Power LED and Keyboard Lock (JFP3)

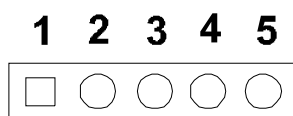

Table B.9: Power LED and Keyboard Lock (JFP3)

Pin	Function
1	LED power (3.3 V)
2	NC
3	Ground
4	#keylock
5	Ground

B.10 External Speaker Connector (JFP2)

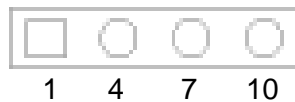

Table B.10: External Speaker Connector (JFP2)

Pin	Function
1	SPK_VCC
4	SPK_OBS
7	SPK_BUZ
10	SPK_OUT

B.11 Reset Connector (JFP1)

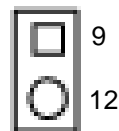

Table B.11: Reset Connector (JFP1)

Pin	Signal
9	RESET
12	GND

B.12 HDD LED Connector (JFP2)

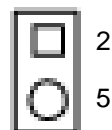

Table B.12: HDD LED Connector (JFP2)

Pin	Signal
2	HDD_LED+
5	HDD_LED-

B.13 ATX Soft Power Switch (JFP1)

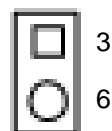
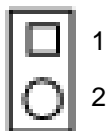

Table B.13: ATX Soft Power Switch (JFP1)

Pin	Signal
3	PWR-BTN
6	GND

B.14 H/W Monitor Alarm (JOBS1)

**Table B.14: H/W Monitor Alarm (JOBS1)**

Pin	Signal
1	Error Beep
2	OBS Beep alarm

B.15 SNMP SM_BUS Bus Connector (JFP2)

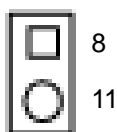
**Table B.15: SM Bus Connector (JFP2)**

Pin	Signal
8	SMB_DATA
11	SMB_CLK

B.16 USB/LAN ports (LAN1_USB12 and LAN2_USB34)

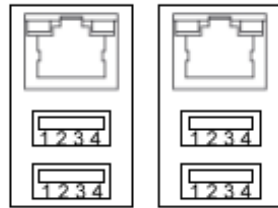

LAN1_USB12 LAN2_USB34

Table B.16: USB Port

Pin	Signal	Pin	Signal
1	VCC_DUAL	3	Data0+
2	Data0-	4	GND

Table B.17: Giga LAN 10/100/1000 Base-T RJ-45 port

Pin	Signal	Pin	Signal
1	MID0+	5	MID2+
2	MID0-	6	MID2+
3	MID1+	7	MID3+
4	MID1-	8	MID3+

B.17 Line Out, Mic IN Connector (AUDIO1)

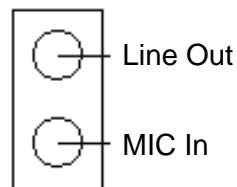

AUDIO1

B.18 Front Panel Audio Connector (FPAUD1)

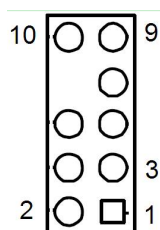

Table B.18: Front Panel Audio Connector (FPAUD1)

Pin	Signal
1	MIC2_L
2	AGND
3	MIC2_R
4	PRESENSE
5	LIN2_R
6	MIC_DEC
7	FIO_JD
8	N/A
9	LIN2_L
10	LINEOUT2_DEC

B.19 8-pin Alarm Board Connector (VOLT1)

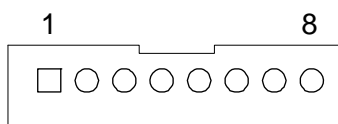

Table B.19: 8-pin Alarm Board Connector (VOLT1)

Pin	Signal	Pin	Signal
1	5VSB	5	VCC
2	GND	6	VCC3
3	GND	7	-12V
4	-5V	8	+12V

B.20 Case Open Connector (JCASE1)

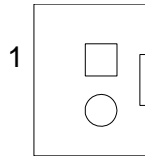

Table B.20: Case Open Connector (JCASE1)

Pin	Signal
1	CASEOP
2	GND

B.21 Front Panel LAN LED Connector (LAN_LED1)

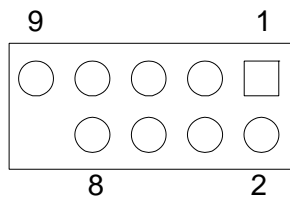

Table B.21: LAN LED Connector (LANLED1)

Pin	Signal	Pin	Signal
1	LAN1_LINK/ACT	2	LAN2_LINK/ACT
3	3VDUAL	4	3VDUAL
5	LAN1_LINK1000	6	LAN2_LINK1000
7	LAN1_LINK100	8	LAN2_LINK100
9	3VDUAL	10	N/C

B.22 SPI_CN1: SPI flash card pin connector

Table B.22: SPI_CN1:SPI fresh card pin connector

Pin	Signal	Pin	Signal
1	+3VSB	2	GND
3	SPI_CS#	4	SPI_CLK
5	SPI_MISO	6	SPI_MOSI
7	N/A	8	NC

B.23 System I/O Ports

Table B.23: System I/O ports

Addr. range (Hex)	Device
000-01F	DMA controller
020-021	Interrupt controller 1, master
022-023	Chipset address
040-05F	8254 timer
060-06F	8042 (keyboard controller)
070-07F	Real-time clock, non-maskable interrupt (NMI) mask
080-09F	DMA page register
0A0-0BF	Interrupt controller 2
0C0-0DF	DMA controller
0F0	Clear math co-processor
0F1	Reset math co-processor
0F8-0FF	Math co-processor
1F0-1F8	Fixed disk
290-297	On-board hardware monitor
2F8-2FF	Serial port 2
300-31F	Prototype card
360-36F	Reserved
380-38F	SDLC, bisynchronous 2
3A0-3AF	Bisynchronous 1
3B0-3BF	Monochrome display and printer adapter (LPT1)
3C0-3CF	Reserved
3D0-3DF	Color/graphics monitor adapter
3F0-3F7	Diskette controller
3F8-3FF	Serial port 1

B.24 DMA Channel Assignments

Table B.24: DMA channel assignments

Channel	Function
0	Available
1	Available
2	Available
3	Available
4	Cascade for DMA controller 1
5	Available
6	Available
7	Available

B.25 Interrupt Assignments

Table B.25: Interrupt assignments

Priority	Interrupt#	Interrupt source
1	NMI	Parity error detected
2	IRQ0	Interval timer
3	IRQ1	Keyboard
-	IRQ2	Interrupt from controller 2 (cascade)
4	IRQ8	Real-time clock
5	IRQ9	Cascaded to INT 0A (IRQ 2)
6	IRQ10	Available/Serial communication port 4
7	IRQ11	Available
8	IRQ12	PS/2 mouse
9	IRQ13	INT from co-processor
10	IRQ14	Available
11	IRQ15	Available
12	IRQ3	Serial communication port 2
13	IRQ4	Serial communication port 1
14	IRQ5	Serial communication port 3
15	IRQ6	Available
16	IRQ7	Parallel port 1 (print port)

B.26 1st MB Memory Map

Table B.26: 1st MB memory map

Addr. range (Hex)	Device
E0000h - FFFFFh	BIOS
CC000h - DFFFFh	Unused
C0000h - CBFFFh	VGA BIOS
A0000h - BFFFFh	Video Memory
00000h - 9FFFFh	Base memory

Trusted ePlatform Services

ADVANTECH

www.advantech.com

Please verify specifications before quoting. This guide is intended for reference purposes only.

All product specifications are subject to change without notice.

No part of this publication may be reproduced in any form or by any means, electronic, photocopying, recording or otherwise, without prior written permission of the publisher.

All brand and product names are trademarks or registered trademarks of their respective companies.

© Advantech Co., Ltd. 2011