



Mini-ITX

AIMB-250 Series

Intel® Pentium® M / Celeron® M Mini ITX Motherboard

User's Manual



1st Ed – January 2007

FCC Statement



THIS DEVICE COMPLIES WITH PART 15 FCC RULES. OPERATION IS SUBJECT TO THE FOLLOWING TWO CONDITIONS:

- (1) THIS DEVICE MAY NOT CAUSE HARMFUL INTERFERENCE.
- (2) THIS DEVICE MUST ACCEPT ANY INTERFERENCE RECEIVED INCLUDING INTERFERENCE THAT MAY CAUSE UNDESIRE OPERATION.

THIS EQUIPMENT HAS BEEN TESTED AND FOUND TO COMPLY WITH THE LIMITS FOR A CLASS "A" DIGITAL DEVICE, PURSUANT TO PART 15 OF THE FCC RULES.

THESE LIMITS ARE DESIGNED TO PROVIDE REASONABLE PROTECTION AGAINST HARMFUL INTERFERENCE WHEN THE EQUIPMENT IS OPERATED IN A COMMERCIAL ENVIRONMENT. THIS EQUIPMENT GENERATES, USES, AND CAN RADIATE RADIO FREQUENCY ENERGY AND, IF NOT INSTALLED AND USED IN ACCORDANCE WITH THE INSTRUCTION MANUAL, MAY CAUSE HARMFUL INTERFERENCE TO RADIO COMMUNICATIONS.

OPERATION OF THIS EQUIPMENT IN A RESIDENTIAL AREA IS LIKELY TO CAUSE HARMFUL INTERFERENCE IN WHICH CASE THE USER WILL BE REQUIRED TO CORRECT THE INTERFERENCE AT HIS OWN EXPENSE.

Notice

This guide is designed for experienced users to setup the system within the shortest time. For detailed information, please always refer to the electronic user's manual.

Copyright Notice

Copyright © 2006 Advantech Corp., ALL RIGHTS RESERVED.

No part of this document may be reproduced, copied, translated, or transmitted in any form or by any means, electronic or mechanical, for any purpose, without the prior written permission of the original manufacturer.

Trademark Acknowledgement

Brand and product names are trademarks or registered trademarks of their respective owners.

Disclaimer

Advantech Corp. reserves the right to make changes, without notice, to any product, including circuits and/or software described or contained in this manual in order to improve design and/or performance. Advantech Corp. assumes no responsibility or liability for the use of the described product(s), conveys no license or title under any patent, copyright, or masks work rights to these products, and makes no representations or warranties that these products are free from patent, copyright, or mask work right infringement, unless otherwise specified. Applications that are described in this manual are for illustration purposes only. Advantech Corp. makes no representation or warranty that such application will be suitable for the specified use without further testing or modification.

Life Support Policy

ADVANTECH CORP. PRODUCTS ARE NOT FOR USE AS CRITICAL COMPONENTS IN LIFE SUPPORT DEVICES OR SYSTEMS WITHOUT THE PRIOR WRITTEN APPROVAL OF ADVANTECH CORP.

As used herein:

1. Life support devices or systems are devices or systems which, (a) are intended for surgical implant into body, or (b) support or sustain life and whose failure to perform, when properly used in accordance with instructions for use provided in the labeling, can be reasonably expected to result in significant injury to the user.
2. A critical component is any component of a life support device or system whose failure to perform can be reasonably expected to cause the failure of the life support device or system, or to affect its safety or effectiveness.

A Message to the Customer

Advantech Customer Services

Each and every Advantech product is built to the most exacting specifications to ensure reliable performance in the harsh and demanding conditions typical of industrial environments. Whether your new Advantech device is destined for the laboratory or the factory floor, you can be assured that your product will provide the reliability and ease of operation for which the name Advantech has come to be known.

Your satisfaction is our primary concern. Here is a guide to Advantech customer services. To ensure you get the full benefit of our services, please follow the instructions below carefully.

Technical Support

We want you to get the maximum performance from your products. So if you run into technical difficulties, we are here to help. For the most frequently asked questions, you can easily find answers in your product documentation. These answers are normally a lot more detailed than the ones we can give over the phone. So please consult the user's manual first.

If you still cannot find the answer, gather all the information or questions that apply to your problem, and with the product close at hand, call your dealer. Our dealers are well trained and ready to give you the support you need to get the most from your Advantech products. In fact, most problems reported are minor and are able to be easily solved over the phone. In addition, free technical support is available from Advantech engineers every business day. We are always ready to give advice on application requirements or specific information on the installation and operation of any of our products. Please do not hesitate to call or e-mail us.

Headquarters

Advantech Corp.

No.1, Alley 20, Lane 26, Rueiguang Road,
Neihu District, Taipei 114,
Taiwan

Tel : +886-2-2792-7818

Fax : +886-2-2794-7306

<http://www.Advantech.com.tw>

Product Warranty

Advantech warrants to you, the original purchaser, that each of its products will be free from defects in materials and workmanship for two years from the date of purchase.

This warranty does not apply to any products which have been repaired or altered by persons other than repair personnel authorized by Advantech, or which have been subject to misuse, abuse, accident or improper installation. Advantech assumes no liability under the terms of this warranty as a consequence of such events. Because of Advantech high quality-control standards and rigorous testing, most of our customers never need to use our repair service. If any of Advantech products is defective, it will be repaired or replaced at no charge during the warranty period. For out-of-warranty repairs, you will be billed according to the cost of replacement materials, service time, and freight. Please consult your dealer for more details. If you think you have a defective product, follow these steps:

1. Collect all the information about the problem encountered. (For example, CPU type and speed, Advantech products model name, hardware & BIOS revision number, other hardware and software used, etc.) Note anything abnormal and list any on-screen messages you get when the problem occurs.
2. Call your dealer and describe the problem. Please have your manual, product, and any helpful information available.
3. If your product is diagnosed as defective, obtain an RMA (return material authorization) number from your dealer. This allows us to process your good return more quickly.
4. Carefully pack the defective product, a complete Repair and Replacement Order Card and a photocopy proof of purchase date (such as your sales receipt) in a shippable container. A product returned without proof of the purchase date is not eligible for warranty service.
5. Write the RMA number visibly on the outside of the package and ship it prepaid to your dealer.

Contents

1. Getting Started	10
.....	10
.....	10
.....	11
.....	12
.....	13
.....	16
1.6.1 Block Diagram	16
1.6.2 Intel 855GME and ICH4	17
1.6.3 Intel 855GME and ICH4	19
1.6.4 DRAM Interface (Intel 855GME)	20
1.6.5 DRAM Interface (Intel 855GME)	20
1.6.6 PCI Interface	20
1.6.7 IDE Interface (Bus Master Capability and Synchronous DMA Mode)	21
1.6.8 USB 2.0	21
1.6.9 VIA VT1616 Audio Codec	21
1.6.10 Chrontel CH7009A TV/DVI Transmitter	22
1.6.11 Ethernet.....	23
1.6.12 Winbond W83627HF.....	24
1.6.13 Compact Flash Interface.....	24
2. Hardware Configuration	25
.....	26
.....	27
2.2.1 Processor Installation	27
2.2.2 Main Memory	29
.....	31
.....	34
2.4.1 Clear CMOS (JBAT1).....	34
2.4.2 COM1 Pin 9 Signal Select (JP1).....	34
2.4.3 COM1 RS-232/422/485 Select (JP2, JP3).....	35
2.4.4 4/5/8-wire Touch Screen Select (SW1, optional)	36
2.4.5 ATX Power Connector (ATXPWR1).....	36
2.4.6 CPU Fan Connector (C_FAN1).....	37
2.4.7 Parallel Port Connector & VGA Connector (CN1).....	38
2.4.8 Serial Port 1 Connector in RS-232 Mode (CN1)	39
2.4.9 Serial Port 1 Connector in RS-422 Mode (CN1)	40

2.4.10	Serial Port 1 Connector in RS-485 Mode (CN1).....	41
2.4.11	Audio Connector (CN2).....	42
2.4.12	RJ-45 Ethernet / USB 0 & 1, 4 & 5 Connectors (CN3, CN4).....	42
2.4.13	4/5/8-Wire Touch Screen Connector (CN5, optional).....	42
2.4.14	Floppy Connector (FLP1).....	43
2.4.15	Primary IDE Connector (IDE_1).....	45
2.4.16	Secondary IDE Connector (IDE_2).....	46
2.4.17	LCD Inverter Connector (JBKL1).....	48
2.4.18	CD-ROM Audio Input Connector (JCD1).....	49
2.4.19	Serial Port 2 Connector (JCOM1).....	49
2.4.20	Serial Port 3/4 Connector (JCOM2, JCOM3).....	50
2.4.21	Digital Input / Output Connector (JDIO1).....	51
2.4.22	Front Panel Connector (JFP1).....	52
2.4.23	IrDA Connector (JIR1)	53
2.4.24	LVDS Connector (JLVDS1)	54
2.4.25	Miscellaneous Setting Connector (JMISC1).....	55
2.4.26	TMDS DVI Connector (JTMDS1).....	56
2.4.27	TV Out Connector (JTV1).....	57
2.4.28	USB Connector 2 & 3 (JUSB1).....	58
2.4.29	USB Connector 4 & 5 (JUSB2).....	58
2.4.30	PS/2 Keyboard & Mouse Connector (KB_MS1).....	59
2.4.31	System Fan Connector 1 & 2 (S_FAN1, S_FAN2).....	59
3	BIOS Setup	60
	61
	62
	63
	63
	64
3.5.1	Standard CMOS Features.....	65
3.5.2	Advanced BIOS Features	67
3.5.3	Advanced Chipset Features	70
3.5.4	Integrated Peripherals	73
3.5.5	Power Management Setup.....	77
3.5.6	PnP / PCI Configuration	79
3.5.7	PC Health Status.....	80
3.5.8	Frequency / Voltage Control	81
3.5.9	Load Fail-Safe Defaults.....	82
3.5.10	Load Optimized Defaults.....	82
3.5.11	Set Supervisor / User Password	83
3.5.12	Save & Exit Setup	84

AIMB-250 Series

3.5.13	Exit Without Save	85
4	Drivers Installation	86
	87
5	Mechanical Drawing	88
Appendix A: AWARD BIOS POST Messages		90
	91
	91
	91
1.	CMOS BATTERY HAS FAILED	91
2.	CMOS CHECKSUM ERROR	91
3.	DISK BOOT FAILURE, INSERT SYSTEM DISK AND PRESS ENTER	91
4.	DISKETTE DRIVES OR TYPES MISMATCH ERROR - RUN SETUP	91
5.	DISPLAY SWITCH IS SET INCORRECTLY	92
6.	DISPLAY TYPE HAS CHANGED SINCE LAST BOOT	92
7.	EISA Configuration Checksum Error PLEASE RUN EISA CONFIGURATION UTILITY	92
8.	EISA Configuration Is Not Complete PLEASE RUN EISA CONFIGURATION UTILITY	92
9.	ERROR ENCOUNTERED INITIALIZING HARD DRIVE	92
10.	ERROR INITIALIZING HARD DISK CONTROLLER	92
11.	FLOPPY DISK CNTRLR ERROR OR NO CNTRLR PRESENT	92
12.	Invalid EISA Configuration PLEASE RUN EISA CONFIGURATION UTILITY	93
13.	KEYBOARD ERROR OR NO KEYBOARD PRESENT	93
14.	Memory Address Error at	93
15.	Memory parity Error at	93
16.	MEMORY SIZE HAS CHANGED SINCE LAST BOOT	93
17.	Memory Verify Error at	93
18.	OFFENDING ADDRESS NOT FOUND	93
19.	OFFENDING SEGMENT:	93
20.	PRESS A KEY TO REBOOT	94
21.	PRESS F1 TO DISABLE NMI, F2 TO REBOOT	94
22.	RAM PARITY ERROR - CHECKING FOR SEGMENT	94
23.	Should Be Empty But EISA Board Found PLEASE RUN EISA CONFIGURATION UTILITY	94
24.	Should Have EISA Board But Not Found PLEASE RUN EISA CONFIGURATION UTILITY	94
25.	Slot Not Empty	94
26.	SYSTEM HALTED, (CTRL-ALT-DEL) TO REBOOT	94
27.	Wrong Board In Slot PLEASE RUN EISA CONFIGURATION UTILITY	95
28.	FLOPPY DISK(S) fail (80) → Unable to reset floppy subsystem	95
29.	FLOPPY DISK(S) fail (40) → Floppy Type mismatch	95
30.	Hard Disk(s) fail (80) → HDD reset failed	95
31.	Hard Disk(s) fail (40) → HDD controller diagnostics failed	95
32.	Hard Disk(s) fail (20) → HDD initialization error	95

33.	Hard Disk(s) fail (10) → Unable to recalibrate fixed disk.....	95
34.	Hard Disk(s) fail (08) → Sector Verify failed.....	95
35.	Keyboard is locked out - Unlock the key.....	95
36.	Keyboard error or no keyboard present.....	95
37.	Manufacturing POST loop.....	95
38.	BIOS ROM checksum error - System halted.....	95
39.	Memory test fail.....	95
40.	POST Codes.....	96

1. Getting Started

1.1 Safety Precautions

Warning!



Always completely disconnect the power cord from your chassis whenever you work with the hardware. Do not make connections while the power is on. Sensitive electronic components can be damaged by sudden power surges. Only experienced electronics personnel should open the PC chassis.

Caution!



Always ground yourself to remove any static charge before touching the CPU card. Modern electronic devices are very sensitive to static electric charges. As a safety precaution, use a grounding wrist strap at all times. Place all electronic components in a static-dissipative surface or static-shielded bag when they are not in the chassis.

1.2 Packing List

Before you begin installing your single board, please make sure that the following materials have been shipped:

- 1 x AIMB-250 Intel Socket 478/479 Pentium® M/Celeron® M Mini ITX Main Board (Onboard Intel® Celeron® M 600 MHz with 0K L2 Cache or Intel® Processor at 800 MHz)
- 1 x CD-ROM or DVD-ROM contains the followings:
 - User's Manual (this manual in PDF file)
 - Intel INF driver
 - Ethernet driver and utilities
 - VGA drivers and utilities
 - Audio drivers and utilities
- 1 x IDE HDD cable (40-pin, pitch 2.54mm)
- 1 x IDE HDD cable (44-pin, pitch 2.0mm)
- 1 x FDD cable (34-pin, pitch 2.54mm)
- 3 x Serial port cable with 1 DB9P(M) (10-pin, pitch 2.54mm)
- Startup manual
- 1 x I/O bracket
- 1 x Pentium® M CPU cooler



If any of the above items is damaged or missing, contact your retailer.

1.3 Document Amendment History

Revision	Date	Comment
1 st	Jan. 2007	Initial release

1.4 Manual Objectives

This manual describes in detail the Advantech Technology AIMB-250 series Single Board.



We have tried to include as much information as possible but we have not duplicated information that is provided in the standard IBM Technical References, unless it proved to be necessary to aid in the understanding of this board.

We strongly recommend that you study this manual carefully before attempting to interface with AIMB-250 series or change the standard configurations. Whilst all the necessary information is available in this manual we would recommend that unless you are confident, you contact your supplier for guidance.





Please be aware that it is possible to create configurations within the CMOS RAM that make booting impossible. If this should happen, clear the CMOS settings, (see the description of the Jumper Settings for details).

If you have any suggestions or find any errors concerning this manual and want to inform us of these, please contact our Customer Service department with the relevant details.

1.5 System Specifications

System 	
Model	AIMB-250F-00B1
CPU	Supports Intel® μ FC-PGA 478 / μ FC-BGA 479 Pentium® M / Celeron® M up to 1.8 GHz with 0.13 μ and 90nm process technology
FSB	400 MHz
BIOS	Award 512 KB Flash BIOS
System Chipset	Intel® 855GME GMCH/ICH4
I/O Chip	Winbond W83627HF-AW
System Memory	One 184-pin DIMM socket supports up to 1 GB DDR 266/333 SDRAM
SSD	One CompactFlash Type I/II socket
Watchdog Timer	Reset: 1 sec.~255 min. and 1 sec. or 1 min./step
H/W Status Monitor	Monitoring system temperature, voltage, and cooling fan status. Auto throttling control when CPU overheats.
Expansion	One PCI slot (PCI Rev. 2.2 compliant), one Mini PCI slot
I/O 	
MIO	4 x EIDE (Ultra DMA 100), 2 x FDD , 1 x LPT, 1 x RS-232, 1x RS-232/422/485, 1x K/B, 1 x Mouse
IrDA	115k bps, IrDA 1.0 compliant
USB	6 USB 2.0 ports
DIO	16-bit General Purpose I/O for DI and DO

AIMB-250 Series

Display 	
Model	AIMB-250
Chipset	Intel® 855GME GMCH integrated Extreme Graphics 2 controller
Display Memory	Intel® DVMT 2.1 supports up to 64 MB video memory
Resolution	CRT mode: 1600 x 1200 @ 32 bpp (85 Hz) LCD/Simultaneous mode: 1600 x 1200 @ 32 bpp (85 Hz)
Dual Display	CRT + LVDS, or DVI/TV-out + LVDS or CRT + DVI
LVDS	Dual-channel 18/36-bit LVDS
DVI	Chrontel CH7009A DVI transmitter up to 135M pixels/second
TV-Out	Chrontel CH7009A TV encoder supports both NTSC/PAL Supports both S-Video and composite video
Built-in Touch Screen  (Optional)	
Chipset	PenMount DMC9000
Touch Screen Interface	With 9-pin 2 mm box header (can be selected with 4/5/8-wire connector)
Audio 	
Chipset	Intel® ICH4
AC97 Codec	VIA VT1616 supports 5.1 CH Audio
Audio Interface	Mic in, Line in, CD Audio in, Line out
Ethernet 	
LAN1	Realtek RTL8110S Gigabit LAN
LAN2	N/A
Ethernet Interface	1000Base-T Gigabit Ethernet compatible: Realtek RTL8110S

Mechanical & Environmental 	
Model	AIMB-250
Power Requirement	+5 V @ 4.45 A, +12 V @ 0.05 A, +3.3 V @ 5.27 A, 5 Vsb @ 0.38 A (with Intel Celeron 1 GHz, 1 GB SDRAM)
Power Type	AT/ATX
Operation Temperature	0~60° C (32~140° F)
Operating Humidity	0%~90% relative humidity, non-condensing
Size (L x W)	6.69" x 6.69" (170 mm x 170 mm)
Weight	0.88 lbs (0.4 Kg)

1.6 Architecture Overview

1.6.1 Block Diagram

The following block diagram shows the architecture and main components of AIMB-250

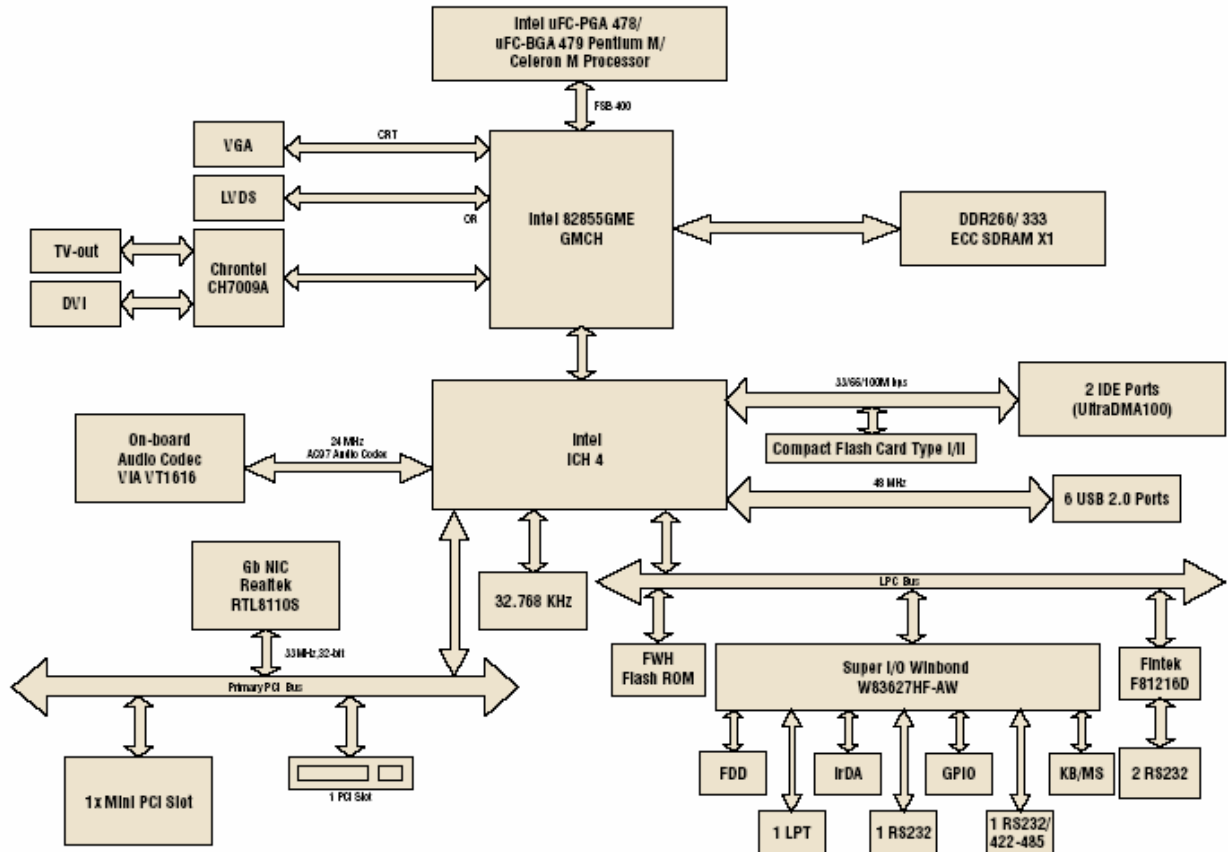

The following sections provide detail information about the functions provided onboard.

1.6.2 Intel 855GME and ICH4

The Intel 855GME GMCH components provide the processor interface, DDR SDRAM interface, display interface, and Hub interface. The Intel 855GME also has an option for AGP external graphics port, in addition to integrated graphics support for added board flexibility options.

The Intel 855GM GMCH is in a 732-pin Micro-FCBGA package and contains the following functionality listed below:

- AGTL+ host bus supporting 32-bit host addressing with Enhanced Intel SpeedStep technology support
- Supports a single channel of DDR SDRAM memory
- System memory supports DDR200/266 MHz (SSTL_2) DDR SDRAM
- Integrated graphics capabilities: Display Core frequency at 133 MHz or 200 MHz
- Render Core frequency at 100 MHz, 133 MHz, and 200 MHz
- Provides supports four display ports: one progressive scan analog monitor, dual channel LVDS interface and two DVO port.

The Intel EE GMCH is in a 732-pin Micro-FCBGA package and contains all features listed above and the additional functionality list below:

- Display Core frequency at 133 MHz, 200 MHz, or 250 MHz
- Render Core frequency at 100 MHz, 133 MHz, 166 MHz, 200 MHz, or 250 MHz
- System memory supports 200/266/333- MHz (SSTL_2) DDR SDRAM.
- Enhanced Power Management Graphics features

The GMCH IGD provides a highly integrated graphics accelerator delivering high performance 2D, 3D, and video capabilities. With its interfaces to UMA using a DVMT configuration, an analog display, a LVDS port, and two digital display ports (e.g. flat panel), the GMCH can provide a complete graphics solution.

The GMCH also provides 2D hardware acceleration for block transfers of data (BLTs). The BLT engine provides the ability to copy a source block of data to a destination and perform raster operations (e.g., ROP1, ROP2, and ROP3) on the data using a pattern, and/or another destination. Performing these common tasks in hardware reduces CPU load, and thus improves performance. High bandwidth access to data is provided through the system memory interface. The GMCH uses Tiling architecture to increase system memory efficiency and thus maximize effective rendering bandwidth. The Intel 855GME GMCH improves 3D performance and quality with 3D Zone rendering technology. The Intel 855GME GMCH also supports Video Mixer rendering and Bi-Cubic filtering.

AIMB-250 Series

The Intel 855GME GMCH has four display ports, one analog and three digital. With these interfaces, the GMCH can provide support for a progressive scan analog monitor, a dedicated dual channel LVDS LCD panel, and two DVO devices. Each port can transmit data according to one or more protocols. The data that is sent out the display port is selected from one of the two possible sources, Pipe A or Pipe B.

The Intel 855GME GMCH have an integrated dual channel LFP Transmitter interface to support LVDS LCD panel resolutions up to UXGA. The display pipe provides panel up-scaling to fit a smaller source image onto a specific native panel size, as well as provides panning and centering support. The LVDS port is only supported on Pipe B. The LVDS port can only be driven by Pipe B, either independently or simultaneously with the Analog Display port. Spread Spectrum Clocking is supported: center and down spread support of 0.5%, 1%, and 2.5% utilizing an external SSC clock.

The DVO B/C interface is compliant with the DVI Specification 1.0. When combined with a DVI compliant external device (e.g. TMDS Flat Panel Transmitter, TV-out encoder, etc.), the GMCH provides a high-speed interface to a digital or analog display (e.g. flat panel, TV monitor, etc.). The DVO ports are connected to an external display device. Examples of this are TV-out encoders, external DACs, LVDS transmitters, and TMDS transmitters. Each display port has control signals that may be used to control, configure and/or determine the capabilities of an external device. The GMCH provides two DVO ports that are each capable of driving a 165-MHz pixel clock at the DVO B or DVO C interface. When DVO B and DVO C are combined into a single DVO port, then an effective pixel rate of 330 MHz can be achieved. The DVO B/C ports can be driven by Pipe A or Pipe B. If driven on Pipe B, then the LVDS port must be disabled.

The ICH4 is a highly integrated multifunctional I/O Controller Hub that provides the interface to the PCI Bus and integrates many of functions needed in today's PC platform. The GMCH and ICH4 communicate over a dedicated hub interface. The ICH4 functions and capabilities include:

- PCI Rev. 2.2 compliant with support for 33MHz PCI operations
- Supports up to 6 Request/Grant pairs (PCI slots)
- Power management logic support
- Enhanced DMA controller, interrupt controller, and timer functions
- Integrated IDE controller; Ultra ATA/100/66/33
- USB host interface; 3 host controllers and supports 6 USB ports; includes a EHCI high-speed 2.0 USB controller

- Integrated LAN controller
- System Management Bus (SMBus) compatible with most IC devices; ICH4 has both bus master and slave capability
- AC '97 2.3 compliant link for audio and telephony codecs; up to 6 channels
- Low Pin Count (LPC) interface
- FWH Interface (FWH Flash BIOS support)
- Alert on LAN* (AOL and AOL2)

1.6.3 Intel 855GME and ICH4

The Intel 855GME GMCH component provides the processor interface, DDR SDRAM interface, display interface, and Hub Interface in an Intel 855GME chipset platform. The Intel 855GME GMCH is optimized for the Mobile Intel Pentium 4 Processor-M, Mobile Intel Celeron processor and Intel Celeron M processor. It supports a single channel of DDR SDRAM memory. Intel 855GME Chipset contains advanced power management logic. The Intel 855GME Chipset platform supports the fourth generation mobile I/O Controller Hub to provide the features required by a mobile platform.

The Intel 855GME GMCH is in a 732-pin Micro-FCBGA package and contains the following functionality:

- Supports single Intel processor configurations at 400-MHz or 3 GB/s
- 1.2-1.30-V AGTL+ host bus supporting 32-bit host bus addressing with Enhanced Intel SpeedStep® technology (Intel Celeron M processor and Intel Celeron Processor do not support Enhanced Intel SpeedStep Technology).
- System Memory supports 200/266-MHz (SSTL_2) DDR DRAM Up to 1 GB (with 256-Mb technology and two SO-DIMMs) of PC1600/2100 DDR SDRAM without ECC
- Integrated graphics capabilities, including 3D rendering acceleration and 2D hardware acceleration
- Integrated 350-MHz, 24-bit RAMDAC with pixel resolution up to 1600x1200 at 85-Hz and up to 1920x1440 @ 60 Hz
- One Dedicated Dual Channel LFP LVDS interface with frequency range of 25 MHz to 112 MHz (single channel/dual channel) for support up to SXGA+ (1400x1050 @ 60 Hz) panel resolutions with maximum pixel depth of 18-bpp
- Integrated PWM (Pulse Width Modulation) interface for LFP backlight inverter control for panel brightness
- One 165-MHz, 12-bit, DVO interface for TV-out encoder and DVI (LVDS transmitter and TMDS transmitter) support I²C and DDC channels supported
- Dual Pipe Independent Display with Tri-view support through LFP, DVO, and CRT
- Deeper Sleep state support

AIMB-250 Series

- Distributed arbitration for highly concurrent operation
- Three USB host controllers provide high performance peripherals with 480 Mbps of bandwidth, while enabling support for up to six USB 2.0 ports. This results in a significant increase over previous integrated 1-4 port hubs at 12 Mbps
- The latest AC '97 implementation delivers 20-bit audio for enhanced sound quality and full surround sound capability. Integrated audio solutions continue to enjoy success as a very cost-effective, yet high-performance solution
- LAN Connect Interface (LCI) provides flexible network solutions such as 10/100 Mbps Ethernet and 10/100 Mbps Ethernet with LAN manageability
- Dual Ultra ATA/100 controllers, coupled with the Intel® Application Accelerator – a performance software package – support faster IDE transfers to storage devices
- Intel Application Accelerator software provides additional performance over native ATA drivers by improving I/O transfer rates and enabling faster O/S load time, resulting in accelerated boot times
- Communication and Network Riser (CNR) offers flexibility in system configuration with a baseline feature set that can be upgraded with an audio card, modem card, or network card

1.6.4 DRAM Interface (Intel 855GME)

The 855GME GMCH system memory controller directly supports the following:

- One channel of PC1600/2100/2700 DDR SDRAM memory
- DDR SDRAM devices with densities of 128-Mb, 256-Mb, and 512-Mb technology
- Up to 1 GB (512-Mb technology) SDRAM

1.6.5 DRAM Interface (Intel 855GME)

The 855GME GMCH system memory controller directly supports the following:

- One channel of PC1600/2100 DDR SDRAM memory
- DDR SDRAM devices with densities of 128-Mb, 256-Mb, and 512-Mb technology
- Variable page sizes of 2-kB, 4-kB, 8-kB, and 16-kB. Page size is individually selected for every row and a maximum of 16 pages may be opened simultaneously

1.6.6 PCI Interface

The ICH4 PCI interface provides a 33 MHz, Rev. 2.2 compliant implementation. All PCI signals are 5V tolerant, except PME#. The ICH2 integrates a PCI arbiter that supports up to six external PCI bus masters in addition to the internal ICH4 requests.

1.6.7 IDE Interface (Bus Master Capability and Synchronous DMA Mode)

The fast IDE interface supports up to four IDE devices providing an interface for IDE hard disks and ATAPI devices. Each IDE device can have independent timings. The IDE interface supports PIO IDE transfers up to 16 Mbytes/sec and Ultra ATA transfers up to 100 Mbytes/sec. It does not consume any ISA DMA resources. The IDE interface integrates 16x32-bit buffers for optimal transfers.

The ICH4's IDE system contains two independent IDE signal channels. They can be electrically isolated independently. They can be configured to the standard primary and secondary channels (four devices). There are integrated series resistors on the data and control lines.

Access to these controllers is provided by two standard IDC 40-pin connectors.

1.6.8 USB 2.0

The ICH4 contains an Enhanced Host Controller Interface (EHCI) compliant host controller that supports USB high-speed signaling. High-speed USB 2.0 allows data transfers up to 480Mb/s which is 40 times faster than full-speed USB. The ICH4 also contains three Universal Host Controller Interface (UHCI) controllers that support USB full-speed and low-speed signaling.

The ICH4 supports 6 USB 2.0 ports. All six USB ports are high-speed, full-speed, and low-speed capable. ICH4's port-routing logic determines whether a USB port is controlled by one of the UHCI controllers or by the EHCI controller.

1.6.9 VIA VT1616 Audio Codec

VIA Technologies' VT1616TM 18-bit audio codec conforms to the AC'97 2.2 specifications. The VT1616 integrates Sample Rate Converters on all channels and can be adjusted in 1Hz increments. There is a provision in hardware for down-mixing the 6 channels into stereo when only two end points are available. The analog mixer circuitry integrates a stereo enhancement to provide a pleasing 3D surround sound effect for stereo media. This codec is designed with aggressive power management to achieve low power consumption. When used with a 3.3V analog supply, power consumption is further reduced. The primary applications for this part are desktop and portable personal computers multimedia subsystems.

AIMB-250 Series

1.6.10 Chrontel CH7009A TV/DVI Transmitter

The Chrontel CH7009A is a display controller device which accepts a digital graphics input signal, and encodes and transmits data through a DVI (DFP can also be supported) or TV output (analog composite, s-video or RGB). The device accepts data over one 12-bit wide variable voltage data port which supports five different data formats including RGB and YCrCb.

The DVI processor includes a low jitter PLL for generation of the high frequency serialized clock, and all circuitries are required to encode, serialize and transmit data. The CH7009 comes in versions able to drive a DVI display at a pixel rate of up to 165MHz, supporting UXGA resolution displays. No scaling of input data is performed on the data output to the DVI device.

The TV-Out processor performs non-interlace to interlace conversion with scaling and flicker filters, and encode the data into any of the NTSC or PAL video standards. The scaling and flicker filter is adaptive and programmable to enable superior text display. Eight graphics resolutions are supported up to 1024 by 768 with full vertical and horizontal underscan capability in all modes. A high accuracy low jitter phase locked loop is integrated to create outstanding video quality. Support is provided for Macrovision™ and RGB bypass mode which enables driving a VGA CRT with the input data.

1.6.11 Ethernet

1.6.11.1 Realtek RTL8110S Gigabit Ethernet Controller

The Realtek RTL8110SB(L) LOM Gigabit Ethernet controllers (RTL8110SB (128 QFP) & RTL8110SBL (128 LQFP)) combine a triple-speed IEEE 802.3 compliant Media Access Controller (MAC) with a triple-speed Ethernet transceiver, 32-bit PCI bus controller, and embedded memory. With state-of-the-art DSP technology and mixed-mode signal technology, they offer high-speed transmission over CAT 5 UTP cable or CAT 3 UTP (10Mbps only) cable. Functions such as Crossover Detection & Auto-Correction, polarity correction, adaptive equalization, cross-talk cancellation, echo cancellation, timing recovery, and error correction are implemented to provide robust transmission and reception capability at high speeds.

The devices support the PCI v2.3 bus interface for host communications with power management and are compliant with the IEEE 802.3 specification for 10/100Mbps Ethernet and the IEEE 802.3ab specification for 1000Mbps Ethernet. They also support an auxiliary power auto-detect function, and will auto-configure related bits of the PCI power management registers in PCI configuration space.

They support the Advanced Configuration Power management Interface (ACPI)--power management for modern operating systems that are capable of Operating System-directed Power Management (OSPM)--to achieve the most efficient power management possible. PCI Message Signaled Interrupt (MSI) is also supported.

In addition to the ACPI feature, the RTL8110SB(L) support remote wake-up (including AMD Magic Packet, Re-LinkOk, and Microsoft® Wake-up frame) in both ACPI and APM (Advanced Power Management) environments. The LWAKE pin provides four different output signals including active high, active low, positive pulse, and negative pulse. The versatility of the LWAKE pin provides motherboards with Wake-On-LAN (WOL) functionality. To support WOL from a deep power down state (e.g. D3cold, i.e. main power is off and only auxiliary exists), the auxiliary power source must be able to provide the needed power for the RTL8110SB(L).

The RTL8110SB(L) is fully compliant with Microsoft® NDIS5 (IP, TCP, UDP) Checksum and Segmentation Task-offload features, and supports IEEE 802 IP Layer 2 priority encoding and 802.1Q Virtual bridged Local Area Network (VLAN). The above features contribute to lowering CPU utilization, especially benefiting performance when in operation on a network server. Also, the devices boost their PCI performance by supporting PCI Memory Read Line & Memory Read Multiple when transmitting, and Memory Write and Invalidate when receiving. To better qualify for server use, the RTL8110SB(L) support the PCI Dual Address Cycle (DAC) command when the assigned buffers reside at a physical memory address higher than 4 Gigabytes.

AIMB-250 Series

1.6.12 Winbond W83627HF

The Winbond W83627F/HF is made to fully comply with Microsoft PC98 and PC99 Hardware Design Guide. Moreover, W83627F/HF is made to meet the specification of PC98/PC99's requirement in the power management: ACPI and DPM (Device Power Management). Super I/O chip provides features as the following:

- Meet LPC Spec. 1.0
- Support LDRQ# (LPC DMA), SERIRQ (serial IRQ)
- Include all features of Winbond I/O W83977TF and W83977EF
- Integrate Hardware Monitor functions
- Compliant with Microsoft PC98/PC99 Hardware Design Guide.
- Support DPM (Device Power Management), ACPI
- Programmable configuration settings
- Single 24 or 48 MHz clock input

1.6.13 Compact Flash Interface

A Compact Flash type II connector is connected to the secondary IDE controller. The Compact Flash storage card is IDE compatible. It is an ideal replacement for standard IDE hard drives. The solid-state design offers no seek errors even under extreme shock and vibration conditions. The Compact Flash storage card is extremely small and highly suitable for rugged environments, thus providing an excellent solution for mobile applications with space limitations. It is fully compatible with all consumer applications designed for data storage PC card, PDA, and Smart Cellular Phones, allowing simple use for the end user. The Compact Flash storage card is O/S independent, thus offering an optimal solution for embedded systems operating in non-standard computing environments. The Compact Flash storage card is IDE compatible and offers various capacities.

2. Hardware Configuration

2.1 Product Overview

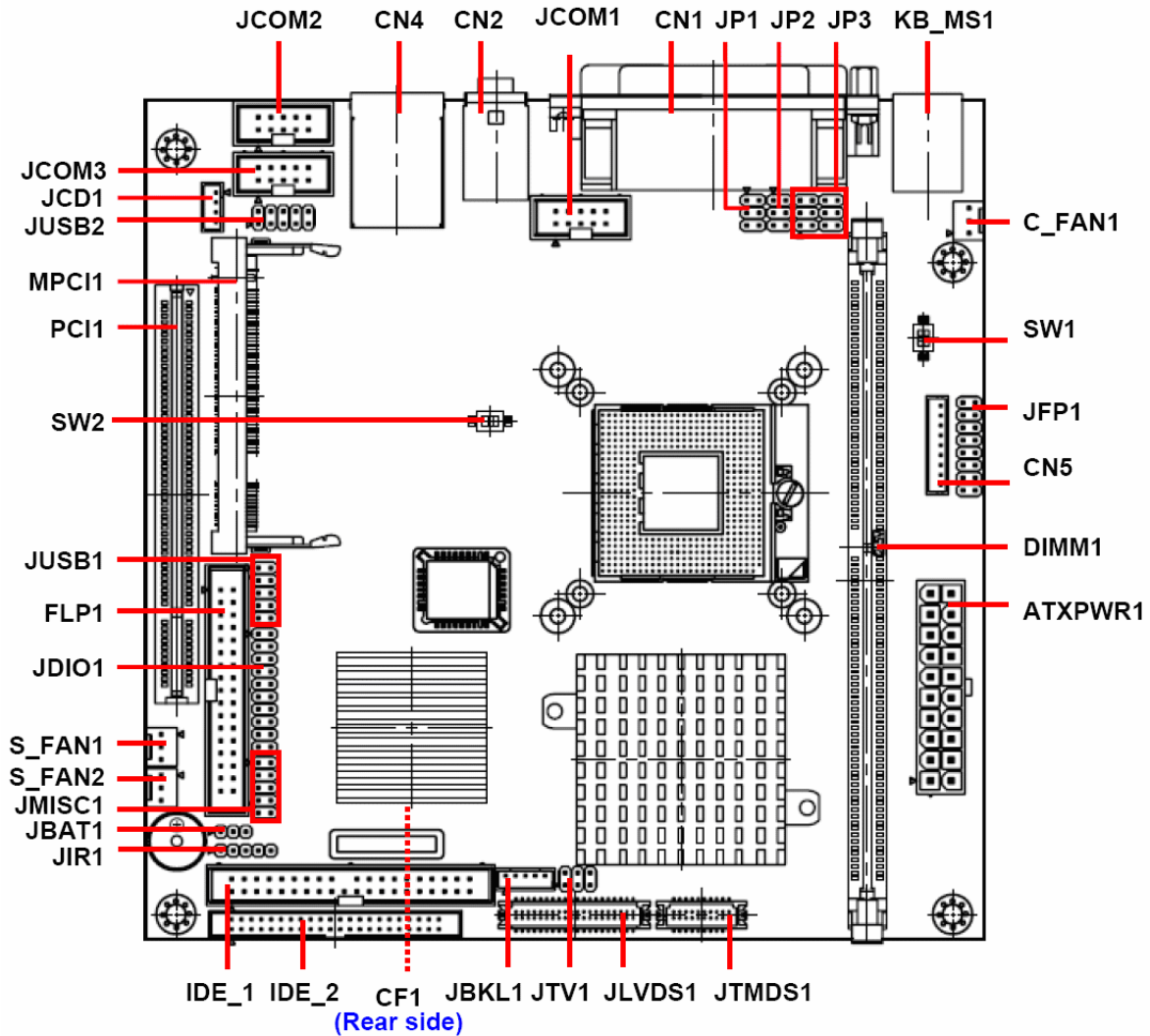

2.2 Installation Procedure

This chapter explains you the instructions of how to setup your system.

1. Turn off the power supply.
2. Insert the DIMM module (be careful with the orientation).
3. Insert all external cables for hard disk, floppy, keyboard, mouse, USB etc. except for flat panel. A CRT monitor must be connected in order to change CMOS settings to support flat panel.
4. Connect power supply to the board via the ATXPWR.
5. Turn on the power.
6. Enter the BIOS setup by pressing the delete key during boot up. Use the "LOAD BIOS DEFAULTS" feature. The **Integrated Peripheral Setup** and the **Standard CMOS Setup** Window must be entered and configured correctly to match the particular system configuration.
7. If TFT panel display is to be utilized, make sure the panel voltage is correctly set before connecting the display cable and turning on the power.

2.2.1 Processor Installation

2.2.1.1 Installing Pentium M CPU

- The processor socket comes with a screw to secure the processor, please unlock the screw first.
- Position the CPU above the socket and the gold triangular mark on the CPU must align with pin 1 of the CPU socket. Then Insert the CPU gently seated in place.
- Turn the screw to the lock position.

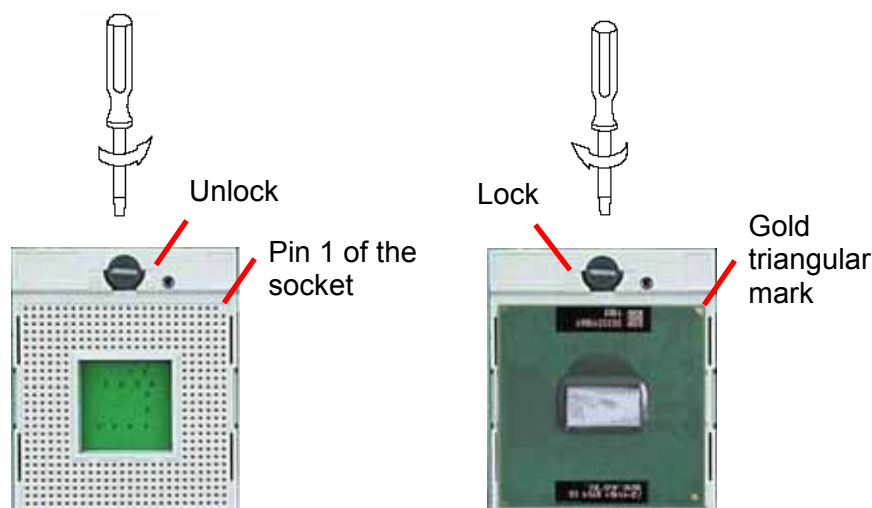

Note: Do not force the CPU into the socket. It may bend the pins and damage the CPU.

2.2.1.2 Installing the Fan and Heat Sink

- Insert the copper studs to the screw holes around the CPU socket from the top through the rear side of the board with screw nuts fastened.

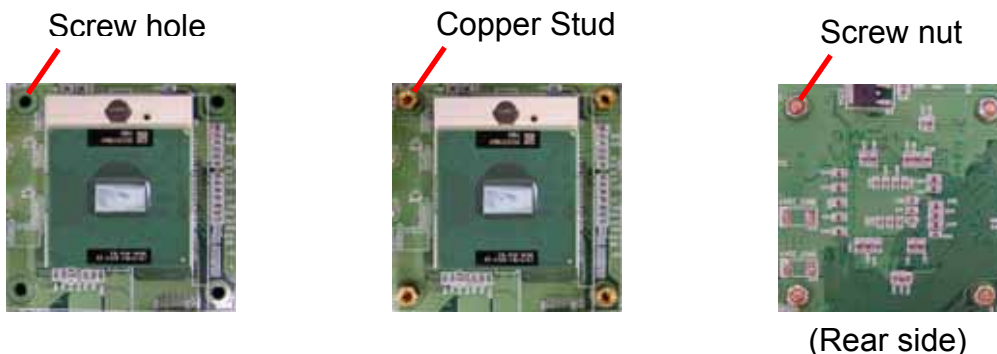

- Match and place the CPU fan and heat sink assembly on the top of the CPU and copper studs. Tighten the screws into the copper studs through washers and the screw holes around the heat sink.
- Place the CPU Fan Connector.

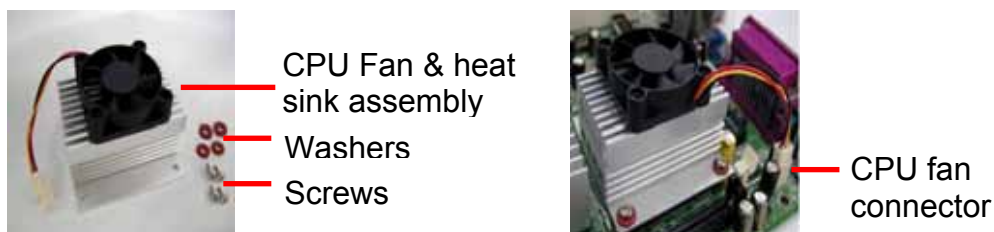

Note: Make sure the CPU fan and heat sink assembly and the CPU top surface are in total contact to avoid CPU overheating problem that would cause the system to hang or unstable

2.2.1.3 Removing CPU

- Disconnect the CPU fan connector.
- Remove the CPU fan and heat sink assembly first.
- Unfasten the copper studs from the board.
- Unlock the Pentium M processor.
- Carefully lift up the existing CPU to remove it from the socket.
- Follow the steps of installing a CPU to change to another one.

2.2.2 Main Memory

AIMB-250 provides one 184-pin DIMM socket to support DDR SDRAM. The total maximum memory size is 1GB.

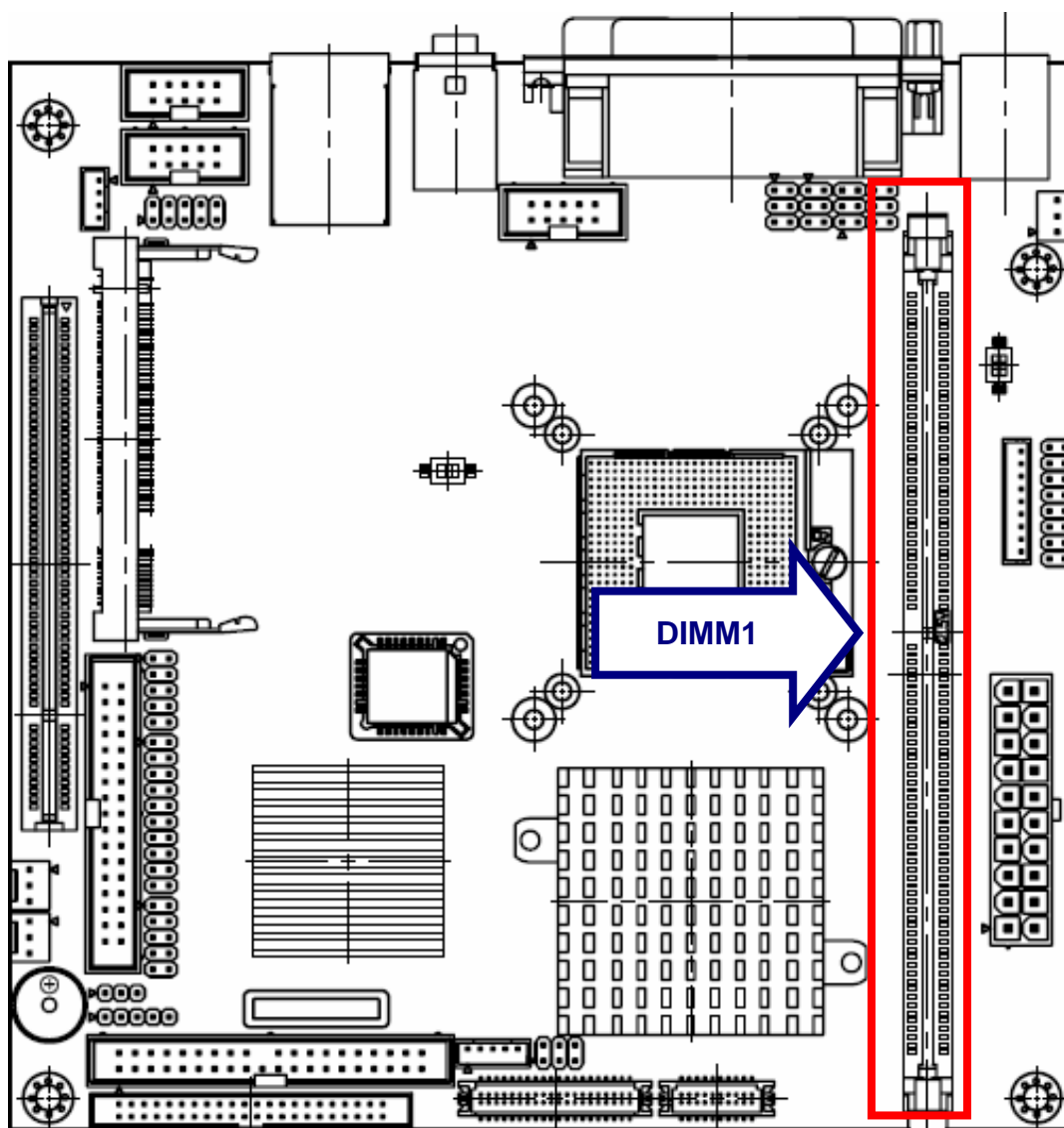

Make sure to unplug the power supply before adding or removing DIMMs or other system components. Failure to do so may cause severe damage to both the board and the components.

AIMB-250 Series

- Locate the DIMM slot on the board.
- Hold two edges of the DIMM module carefully. Keep away of touching its connectors.
- Align the notch key on the module with the rib on the slot.
- Firmly press the modules into the slot automatically snaps into the mounting notch. Do not force the DIMM module in with extra force as the DIMM module only fit in one direction.

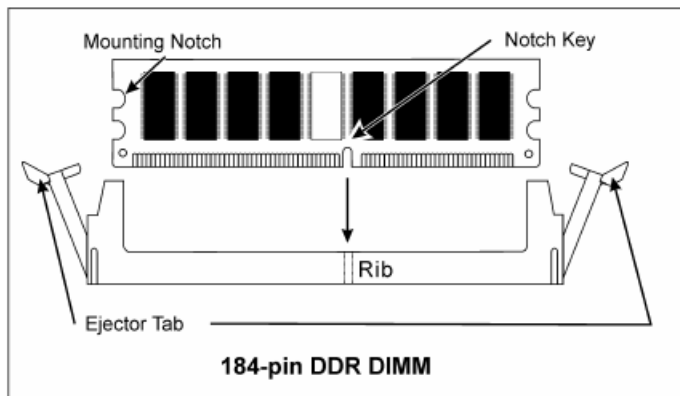

- To remove the DIMM modules, push the two ejector tabs on the slot outward simultaneously, and then pull out the DIMM module.

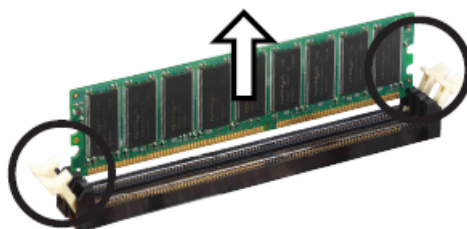

- Note:** (1) Please do not change any DDR SDRAM parameter in BIOS setup to increase your system's performance without acquiring technical information in advance.
- (2) Static electricity can damage the electronic components of the computer or optional boards. Before starting these procedures, ensure that you are discharged of static electricity by touching a grounded metal object briefly.

2.3 Jumper and Connector List

You can configure your board to match the needs of your application by setting jumpers. A jumper is the simplest kind of electric switch.

It consists of two metal pins and a small metal clip (often protected by a plastic cover) that slides over the pins to connect them. To “close” a jumper you connect the pins with the clip. To “open” a jumper you remove the clip. Sometimes a jumper will have three pins, labeled 1, 2, and 3. In this case, you would connect either two pins.

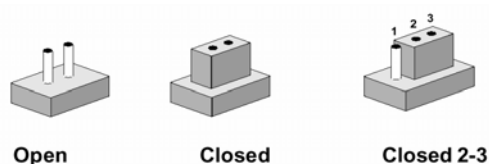

The jumper settings are schematically depicted in this manual as follows:



A pair of needle-nose pliers may be helpful when working with jumpers.

Connectors on the board are linked to external devices such as hard disk drives, a keyboard, or floppy drives. In addition, the board has a number of jumpers that allow you to configure your system to suit your application.

If you have any doubts about the best hardware configuration for your application, contact your local distributor or sales representative before you make any changes.

The following tables list the function of each of the board's jumpers and connectors.

Jumpers

Label	Function	Note
JBAT1	Clear CMOS	3 x 1 header, pitch 2.54mm
JP1	COM1 pin 9 signal select	3 x 2 header, pitch 2.0mm
JP2, JP3	COM1 RS-232/422/485 select	3 x 2 header, pitch 2.0mm 4 x 3 header, pitch 2.0mm
SW1	4/5/8-wire touch screen select (optional)	Switch
SW2	Reserved	Switch

AIMB-250 Series

Connectors

Label	Function	Note
ATXPWR1	ATX Power connector	ATX power connector
C_FAN1	CPU fan connector	3 x 1 wafer, pitch 2.54mm
CF1	CF card connector	
CN1	Parallel port connector Serial port 1 connector VGA connector	D-sub 25-pin, female D-sub 9-pin, male D-sub 15-pin, female
CN2	Audio connector	Phone Jack X 3
CN4	RJ-45 Ethernet / USB 0 & 1 connector	
CN5	4/5/8-wire touch screen connector (option)	9 x 1 wafer, pitch 2.0mm
DIMM1	184-pin DDR SDRAM DIMM socket	
FLP1	Floppy connector	17 x 2 header, pitch 2.54mm
IDE_1	Primary IDE connector	20 x 2 header, pitch 2.54mm
IDE_2	Secondary IDE connector	22 x 2 header, pitch 2.0mm
JBKL1	LCD inverter connector	5 x 1 wafer, pitch 2.0mm
JCD1	CD-ROM audio input connector	4 x 1 wafer, pitch 2.0mm
JCOM1	Serial port 2 connector	5 x 2 header, pitch 2.54mm
JCOM2	Serial port 3 connector	5 x 2 header, pitch 2.54mm
JCOM3	Serial port 4 connector	5 x 2 header, pitch 2.54mm
JDIO1	Digital input/output connector	10 x 2 header, pitch 2.54mm
JFP1	Front panel connector	8 x 2 header, pitch 2.54mm
JIR1	IrDA connector	5 x 1 header, pitch 2.54mm
JLVDS1	LVDS connector	HIROSE DF13-40DP-1.25V
JMISC1	Miscellaneous setting connector	5 x 2 header, pitch 2.54mm
JTMDS1	TMDS connector	HIROSE DF13-20DP-1.25V
JTV1	TV out connector	3 x 2 header, pitch 2.54mm
JUSB1	USB connector 2 & 3	5 x 2 header, pitch 2.54mm
JUSB2	USB connector 4 & 5	5 x 2 header, pitch 2.54mm

Connectors

Label	Function	Note
KB_MS1	PS/2 Keyboard & mouse connector	6-pin Mini-DIN x 2
MPCI1	Mini PCI slot	
PCI1	PCI slot	
S_FAN1,S_FAN2	System fan connector 1 & 2	3 x 1 wafer, pitch 2.54mm

2.4 Setting Jumpers & Connectors

2.4.1 Clear CMOS (JBAT1)

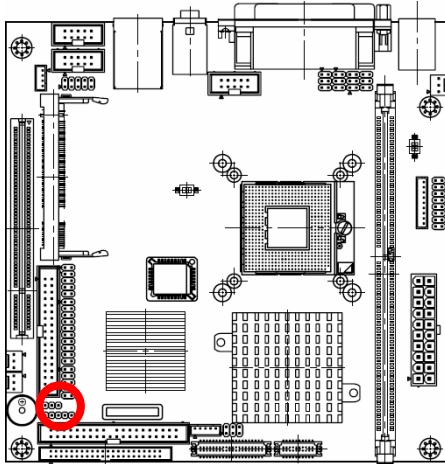

Protect*

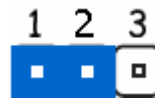

Clear CMOS

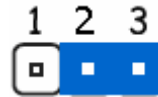

* Default

2.4.2 COM1 Pin 9 Signal Select (JP1)

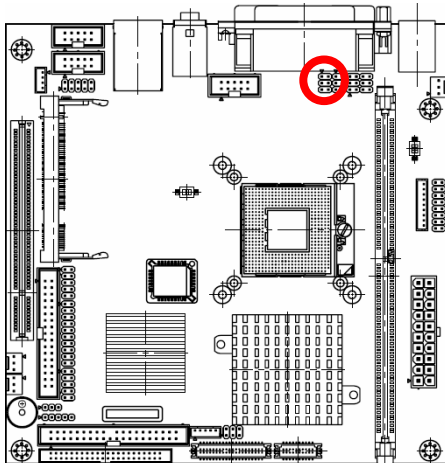

+5V

Ring*

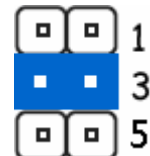
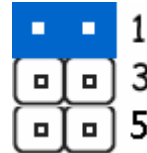

+12V

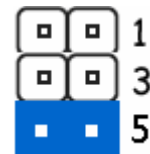

* Default

2.4.3 COM1 RS-232/422/485 Select (JP2, JP3)

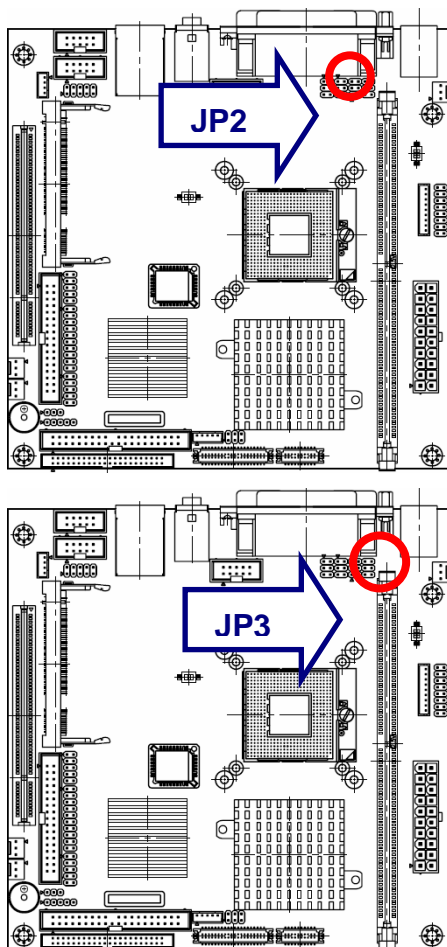

(JP2)
RS-232*

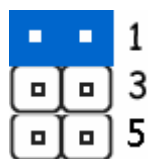

(JP3)
RS-232*

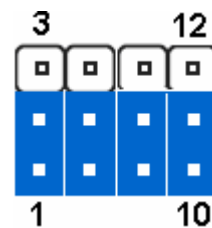

RS-422

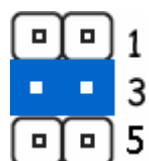

RS-422

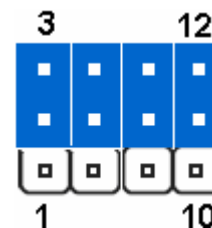

RS-485

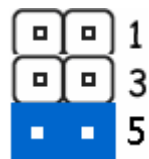

RS-485

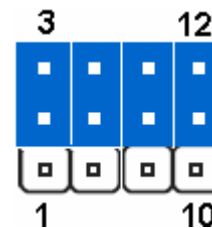

* Default

AIMB-250 Series

2.4.4 4/5/8-wire Touch Screen Select (SW1, optional)

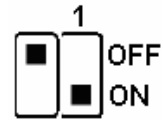
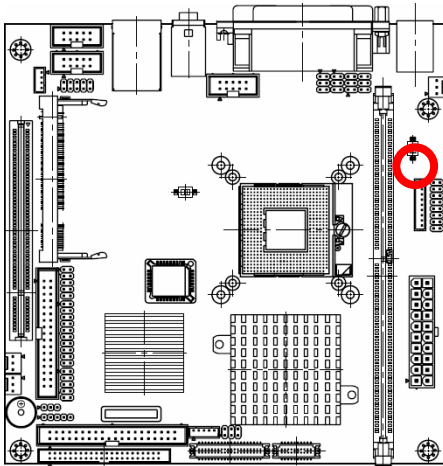

Wire	BIT1	BIT2
* 4, 8	OFF	ON
5	ON	OFF

* Default

2.4.5 ATX Power Connector (ATXPWR1)

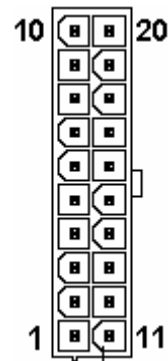
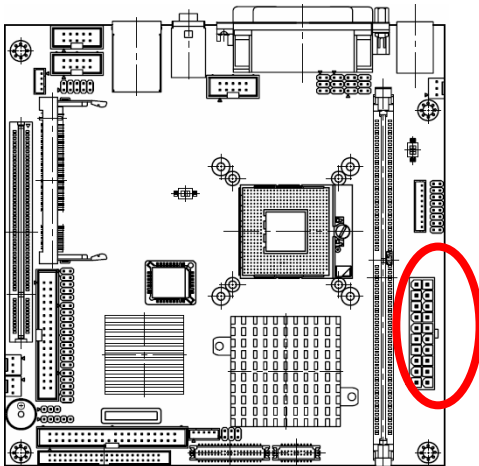

Signal	PIN	PIN	Signal
+12V	10	20	+5V
VCCSB	9	19	+5V
PWROK	8	18	-5V
GND	7	17	GND
+5V	6	16	GND
GND	5	15	GND
+5V	4	14	PS_ON
GND	3	13	GND
+3.3V	2	12	-12V
+3.3V	1	11	+3.3V

2.4.6 CPU Fan Connector (C_FAN1)

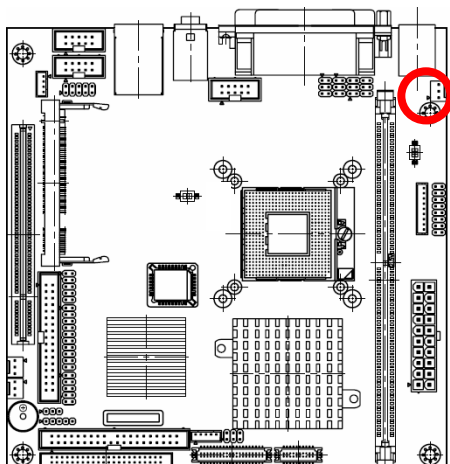

Signal	PIN
TAC	3
+12V	2
GND	1

2.4.6.1 Signal Description – CPU Fan Connector (C_FAN1)

Signal	Signal Description
TAC	Fan speed monitor

AIMB-250 Series

2.4.7 Parallel Port Connector & VGA Connector (CN1)

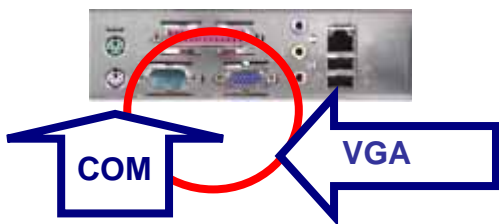

Port	Description
Parallel	Connects a parallel printer, a scanner, or other devices.
COM	For pointing devices or other serial devices

VGA

Signal	PIN		Signal
		6	GND
RED	1	11	NC
		7	GND
GREEN	2	12	DAT
		8	GND
BLUE	3	13	HSYNC
		9	VCC
NC	4	14	VSYNC
		10	GND
GND	5	15	DCK

2.4.7.1 Signal Description – VGA Connector (CN1)

Signal	Signal Description
HSYNC	CRT horizontal synchronisation output.
VSYNC	CRT vertical synchronisation output.
DCK	Display Data Channel Clock. Used as clock signal to/from monitors with DDC interface.
DAT	Display Data Channel Data. Used as data signal to/from monitors with DDC interface.
RED	Analog output carrying the red colour signal to the CRT. For 75 Ω cable impedance.
GREEN	Analog output carrying the green colour signal to the CRT. For 75 Ω cable impedance.
BLUE	Analog output carrying the blue colour signal to the CRT. For 75 Ω cable impedance.

2.4.8 Serial Port 1 Connector in RS-232 Mode (CN1)

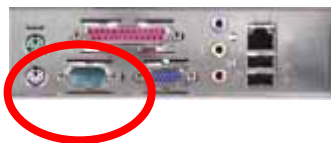

Signal	PIN	PIN	Signal
DCD	1	2	RxD
TxD	3	4	DTR
GND	5	6	DSR
RTS	7	8	CTS
RI/+5V/+12V	9	10	NC

2.4.8.1 Signal Description – Serial Port 1 Connector in RS-232 Mode (CN1)

Signal	Signal Description
TxD	Serial output. This signal sends serial data to the communication link. The signal is set to a marking state on hardware reset when the transmitter is empty or when loop mode operation is initiated.
RxD	Serial input. This signal receives serial data from the communication link.
DTR	Data Terminal Ready. This signal indicates to the modem or data set that the on-board UART is ready to establish a communication link.
DSR	Data Set Ready. This signal indicates that the modem or data set is ready to establish a communication link.
RTS	Request To Send. This signal indicates to the modem or data set that the on-board UART is ready to exchange data.
CTS	Clear To Send. This signal indicates that the modem or data set is ready to exchange data.
DCD	Data Carrier Detect. This signal indicates that the modem or data set has detected the data carrier.
RI	Ring Indicator. This signal indicates that the modem has received a telephone ringing signal.

AIMB-250 Series

2.4.9 Serial Port 1 Connector in RS-422 Mode (CN1)

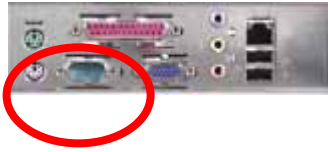

Signal	PIN	PIN	Signal
TxD-	1	2	RxD+
TxD+	3	4	RxD-
GND	5	6	NC
NC	7	8	NC
NC	9	10	NC

2.4.9.1 Signal Description – Serial Port 1 Connector in RS-422 Mode (CN1)

Signal	Signal Description
TxD+/-	Serial output. This differential signal pair sends serial data to the communication link. Data is transferred from Serial Port 2 Transmit Buffer Register to the communication link, if the RTS register of the Serial Port 2 is set to LOW.
RxD+/-	Serial input. This differential signal pair receives serial data from the communication link. Received data is available in Serial Port 2 Receiver Buffer Register.

2.4.10 Serial Port 1 Connector in RS-485 Mode (CN1)

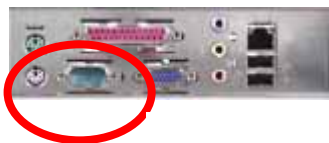

Signal	PIN	PIN	Signal
DATA-	1	2	NC
DATA+	3	4	NC
GND	5	6	NC
NC	7	8	NC
NC	9	10	NC

2.4.10.1 Signal Description – Serial Port 1 Connector in RS-485 Mode (CN1)

Signal	Signal Description
DATA+/-	This differential signal pair sends and receives serial data to the communication link. The mode of this differential signal pair is controlled through the RTS register of Serial Port 2. Set the RTS register of the Serial Port 2 to LOW for transmitting, HIGH for receiving.



Do not select a mode different from the one used by the connected peripheral, as this may damage CPU board and/or peripheral.

The transmitter drivers in the port are short circuit protected by a thermal protection circuit. The circuit disables the drivers when the die temperature reaches 150 °C.

RS-422 mode is typically used in point to point communication. Data and control signal pairs should be terminated in the receiver end with a resistor matching the cable impedance (typical 100-120 Ω). The resistors could be placed in the connector housing.

RS-485 mode is typically used in multi drop applications, where more than 2 units are communicating. The data and control signal pairs should be terminated in each end of the communication line with a resistor matching the cable impedance (typical 100-120 Ω). Stubs to substations should be avoided.

AIMB-250 Series

2.4.11 Audio Connector (CN2)

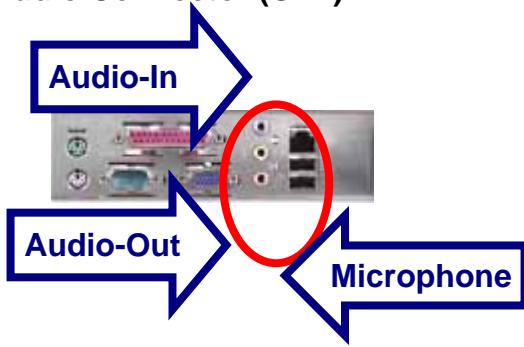

Port	Description
Audio-In	Connects a tape player or other audio sources.
Audio-Out	Connects a headphone or a speaker.
Microphone	Connects a microphone.

2.4.12 RJ-45 Ethernet / USB 0 & 1, 4 & 5 Connectors (CN3, CN4)

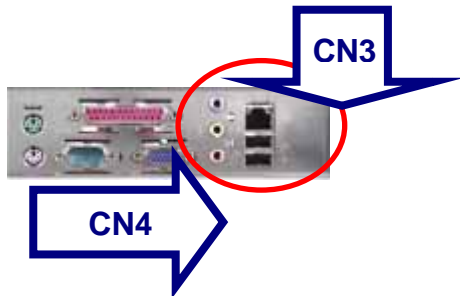

Port	Description
RJ-45	Allows connection to a Local Area Network (LAN) through a network hub.
USB 2.0	For connecting USB port 0, 1 (CN4), 4, 5 (CN3)

2.4.13 4/5/8-Wire Touch Screen Connector (CN5, optional)

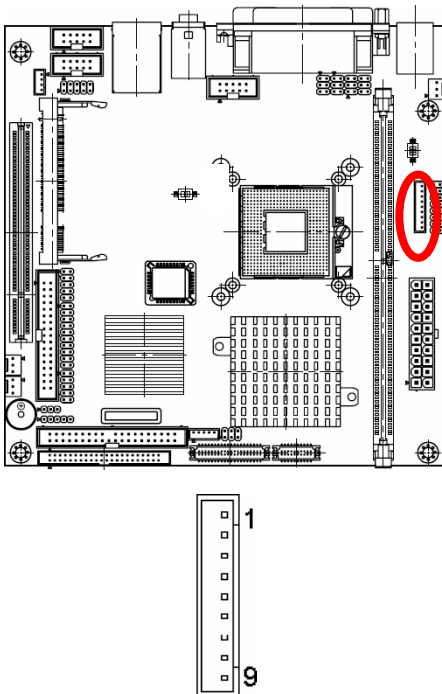

PIN	4-Wire	5-Wire	8-Wire
1	NA	NA	Right Sense
2	NA	NA	Left Sense
3	NA	NA	Bottom Sense
4	NA	Sense	Top Sense
5	Right	LR	Right Excite
6	Left	LL	Left Excite
7	Bottom	UR	Bottom Excite
8	Top	UL	Top Excite
9	GND	GND	GND

2.4.14 Floppy Connector (FLP1)

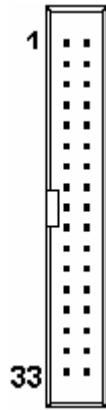
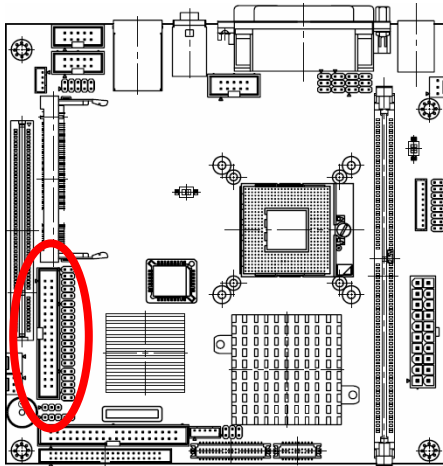

Signal	PIN	PIN	Signal
GND	1	2	REDWC
GND	3	4	NC
GND	5	6	NC
GND	7	8	INDEX
GND	9	10	MOTSA
GND	11	12	DRVSB
GND	13	14	DRVSA
GND	15	16	MOTEB
GND	17	18	DIR
GND	19	20	STEP
GND	21	22	WDATA
GND	23	24	WGATE
GND	25	26	TK00
GND	27	28	WPT
GND	29	30	RDATA
GND	31	32	SIDE1
GND	33	34	DSKCHG

AIMB-250 Series

2.4.14.1 Signal Description – Floppy Connector (FLP)

Signal	Signal Description
RDATA	The read data input signal from the FDD.
WDATA	Write data. This logic low open drain writes pre-compensation serial data to the selected FDD. An open drain output.
WGATE	Write enable. An open drain output.
MOATSA	Motor A On. When set to 0, this pin enables disk drive 0. This is an open drain output.
MOTEB	Motor B On. When set to 0, this pin enables disk drive 1. This is an open drain output.
DRVSA	Drive Select A. When set to 0, this pin enables disk drive A. This is an open drain output.
DRVSB	Drive Select B. When set to 0, this pin enables disk drive B. This is an open drain output.
SIDE1	This output signal selects side of the disk in the selected drive.
DIR	Direction of the head step motor. An open drain output Logic 1 = outward motion Logic 0 = inward motion
STEP	Step output pulses. This active low open drain output produces a pulse to move the head to another track.
REDWC	This output indicates whether a low drive density (250/300kbps at low level) or a high drive density (500/1000kbps at high level) has been selected.
TK00	Track 0. This Schmitt-triggered input from the disk drive is active low when the head is positioned over the outermost track.
INDEX	This Schmitt-triggered input from the disk drive is active low when the head is positioned over the beginning of a track marked by an index hole.
WPT	Write protected. This active low Schmitt input from the disk drive indicates that the diskette is write-protected.
DSKCHG	Diskette change. This signal is active low at power on and whenever the diskette is removed.

2.4.15 Primary IDE Connector (IDE_1)

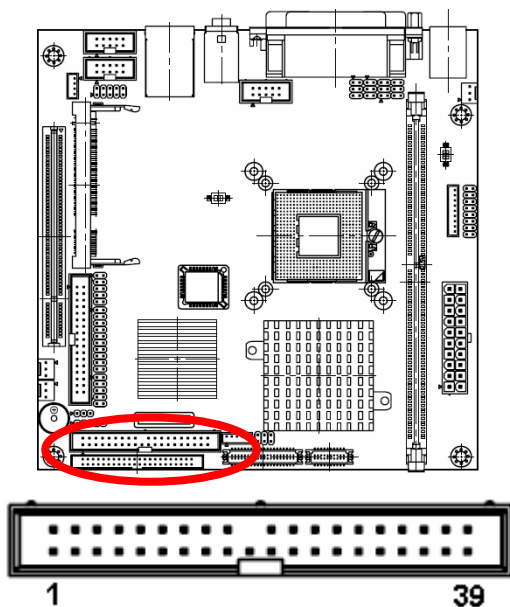

Signal	PIN	PIN	Signal
RESET#	1	2	GND
PDD7	3	4	PDD8
PDD6	5	6	PDD9
PDD5	7	8	PDD10
PDD4	9	10	PDD11
PDD3	11	12	PDD12
PDD2	13	14	PDD13
PDD1	15	16	PDD14
PDD0	17	18	PDD15
GND	19	20	NC
PDREQ	21	22	GND
PDIOW#	23	24	GND
PDIOR#	25	26	GND
PIORDY	27	28	GND
PDDACK#	29	30	GND
IRQ14	31	32	NC
PDA1	33	34	PATADET
PDA0	35	36	PDA2
PDCS1#	37	38	PDCS3#
IDEACTP#	39	40	GND

AIMB-250 Series

2.4.16 Secondary IDE Connector (IDE_2)

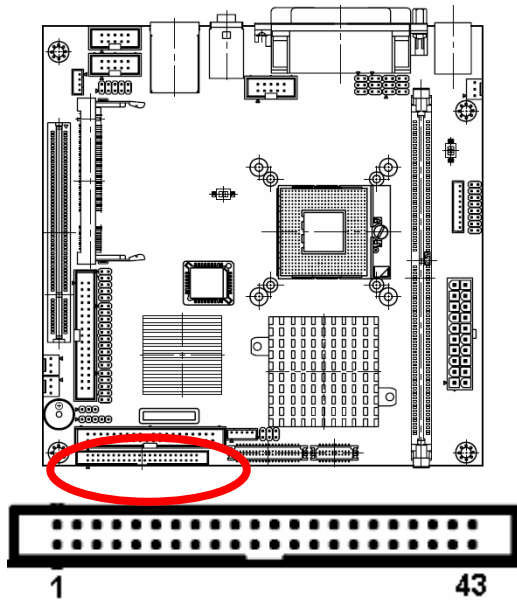

Signal	PIN	PIN	Signal
RESET#	1	2	GND
SDD7	3	4	SDD8
SDD6	5	6	SDD9
SDD5	7	8	SDD10
SDD4	9	10	SDD11
SDD3	11	12	SDD12
SDD2	13	14	SDD13
SDD1	15	16	SDD14
SDD0	17	18	SDD15
GND	19	20	NC
SDREQ	21	22	GND
SDIOW#	23	24	GND
SDIOR#	25	26	GND
SIORDY	27	28	GND
SDDACK#	29	30	GND
IRQ15	31	32	NC
SDA1	33	34	SATADET
SDA0	35	36	SDA2
SDCS1#	37	38	SDCS3#
IDEACTP#	39	40	GND
+5V	41	42	+5V
GND	43	44	NC

Due to IDE compatibility issue, do not use CF and IDE device on secondary IDE channel at the same time.

2.4.16.1 Signal Description – Primary / Secondary IDE Connector (IDE_1, IDE_2)

The IDE interface supports PIO modes 0 to 4 and Bus Master IDE. Data transfer rates up to 100 MB/Sec is possible.

Signal	Signal Description
DA [2:0]	IDE Address Bits. These address bits are used to access a register or data port in a device on the IDE bus.
DCS1#, DCS3#	IDE Chip Selects. The chip select signals are used to select the command block registers in an IDE device. DCS1# selects the primary hard disk.
D [15:0]	IDE Data Lines. D [15:0] transfers data to/from the IDE devices.
IOR#	IDE I/O Read. Signal is asserted on read accesses to the corresponding IDE port addresses.
IOW#	IDE I/O Write. Each signal is asserted on write accesses to corresponding the IDE port addresses.
IRDY	When deasserted, these signals extend the transfer cycle of any host register access when the device is not ready to respond to the data transfer request.
RESET#	IDE Reset. This signal resets all the devices that are attached to the IDE interface.
IRQ14	Interrupt line from hard disk. Connected directly to PC-AT bus.
DREQ	The DREQ is used to request a DMA transfer from the South Bridge. The direction of the transfers is determined by the IOR#/IOW# signals.
DACK#	DMA Acknowledge. The DACK# acknowledges the DREQ request to initiate DMA transfers.
DACT#	Signal from hard disk indicating hard disk activity. The signal level depends on the hard disk type, normally active low. The signal is routed directly to the LED1.
PATADET, SATADET	Primary/Secondary IDE detected.

AIMB-250 Series

2.4.17 LCD Inverter Connector (JBKL1)

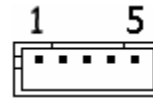
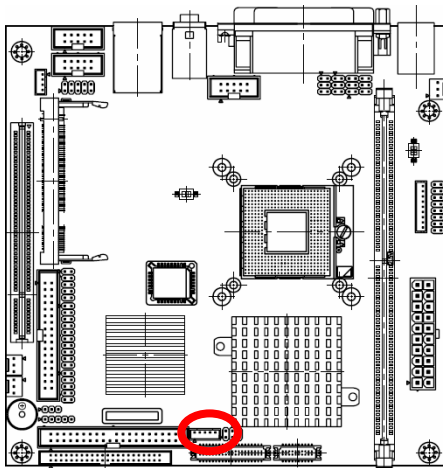

Signal	PIN
+12V	1
GND	2
ENBKL	3
VR	4
+5V	5



Note:

For inverters with adjustable Backlight function, it is possible to control the LCD brightness through the VR signal controlled by **JMISC**. Please see the **JMISC** section for detailed circuitry information.

2.4.17.1 Signal Description – LCD Inverter Connector (JBKL1)

Signal	Signal Description
VR	$V_{adj} = 0.75V \sim 4.25V$ (Recommended: $4.7K\Omega$, $>1/16W$)
ENBKL	LCD backlight ON/OFF control signal

2.4.18 CD-ROM Audio Input Connector (JCD1)

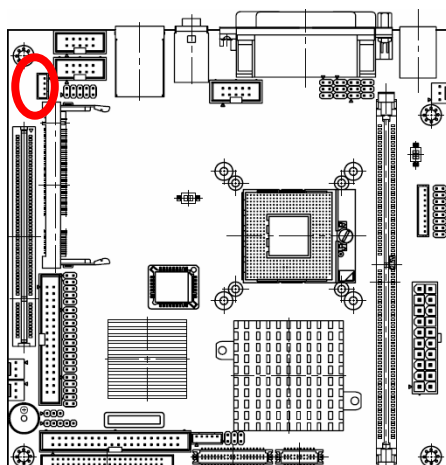

Signal	PIN
CD_L	1
GND	2
GND	3
CD_R	4

2.4.18.1 Signal Description – CD-ROM Audio Input Connector (JCD1)

Signal	Signal Description
CD_R	Right CD-IN signal
CD_L	Left CD-IN signal

2.4.19 Serial Port 2 Connector (JCOM1)

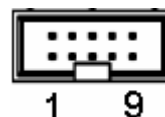
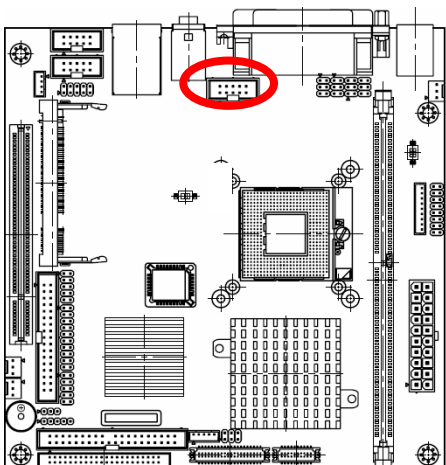

Signal	PIN	PIN	Signal
DCD	1	2	RxD
TxD	3	4	DTR
GND	5	6	DSR
RTS	7	8	CTS
RI	9	10	NC

AIMB-250 Series

2.4.20 Serial Port 3/4 Connector (JCOM2, JCOM3)

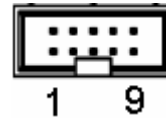
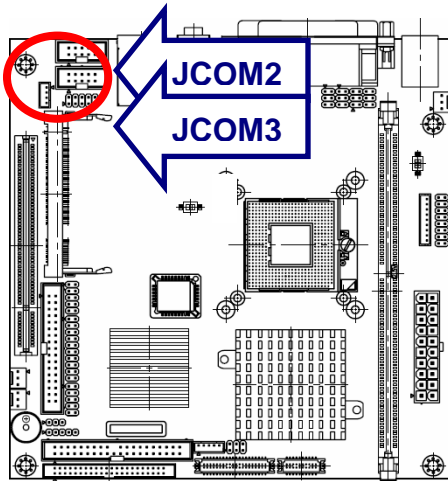

Signal	PIN	PIN	Signal
DCD	1	2	RxD
TxD	3	4	DTR
GND	5	6	DSR
RTS	7	8	CTS
RI	9	10	NC

2.4.20.1 Signal Description – Serial Port 2/3/4 Connector (JCOM1, JCOM2, JCOM3)

Signal	Signal Description
TxD	Serial output. This signal sends serial data to the communication link. The signal is set to a marking state on hardware reset when the transmitter is empty or when loop mode operation is initiated.
RxD	Serial input. This signal receives serial data from the communication link.
DTR	Data Terminal Ready. This signal indicates to the modem or data set that the on-board UART is ready to establish a communication link.
DSR	Data Set Ready. This signal indicates that the modem or data set is ready to establish a communication link.
RTS	Request To Send. This signal indicates to the modem or data set that the on-board UART is ready to exchange data.
CTS	Clear To Send. This signal indicates that the modem or data set is ready to exchange data.
DCD	Data Carrier Detect. This signal indicates that the modem or data set has detected the data carrier.
RI	Ring Indicator. This signal indicates that the modem has received a telephone ringing signal.

2.4.21 Digital Input / Output Connector (JDIO1)

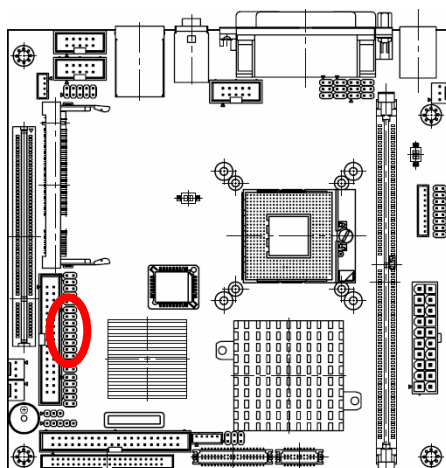

Signal	PIN	PIN	Signal
DIO0	1	2	DIO10
DIO1	3	4	DIO11
DIO2	5	6	DIO12
DIO3	7	8	DIO13
DIO4	9	10	DIO14
DIO5	11	12	DIO15
DIO6	13	14	DIO16
DIO7	15	16	DIO17
SMB_CLK_S	17	18	SMB_DATA_S
GND	19	20	+5V

2.4.21.1 Signal Description – Digital Input / Output Connector (JDIO1)

Signal	Signal Description
DI [0:17]	Digital Input/Output Data Bit 0 to Bit 17
SMB_CLK	Data input for I ² C input, 5V tolerant
SMB_DATA	Data input for I ² C serial input, 5V tolerant

AIMB-250 Series

2.4.22 Front Panel Connector (JFP1)

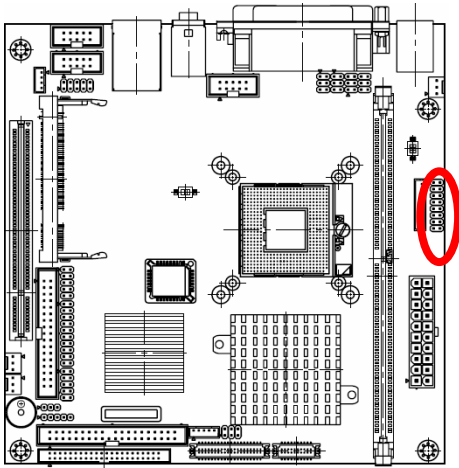

Signal	PIN	PIN	Signal
RESET	1	2	SYS_LED+
GND	3	4	SYS_LED-
HDD_LED+	5	6	PWR_LED+
HDD_LED-	7	8	PWR_LED-
VCCSB	9	10	SUS_LED+
PWR_BUT	11	12	SUS_LED-
SUS_BUT	13	14	SPK+
GND	15	16	SPK-

y

2.4.22.1 Signal Description – Front Panel Connector (JFP1)

PIN No.	Description
1, 3	Reset SW
2, 4	System LED
5, 7	HDD LED
6, 8	Power-On LED
9, 11	Power SW
10, 12	Suspend LED
13, 15	Suspend SW
14, 16	Speaker

System LED will be on as long as power supply is connected.

2.4.23 IrDA Connector (JIR1)

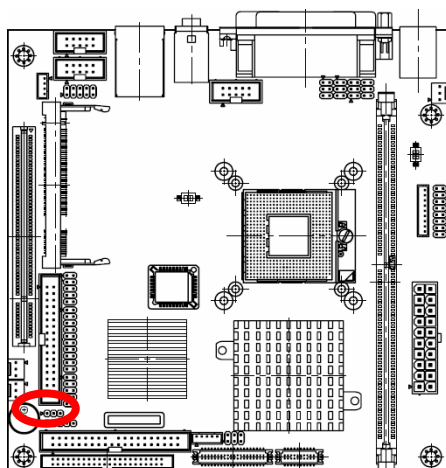

Signal	PIN
+5V	1
NC	2
IRRX	3
GND	4
IRTX	5

2.4.23.1 Signal Description – IrDA Connector (JIR1)

Signal	Signal Description
IRRX	Infrared Receiver input
IRTX	Infrared Transmitter output

AIMB-250 Series

2.4.24 LVDS Connector (JLVDS1)

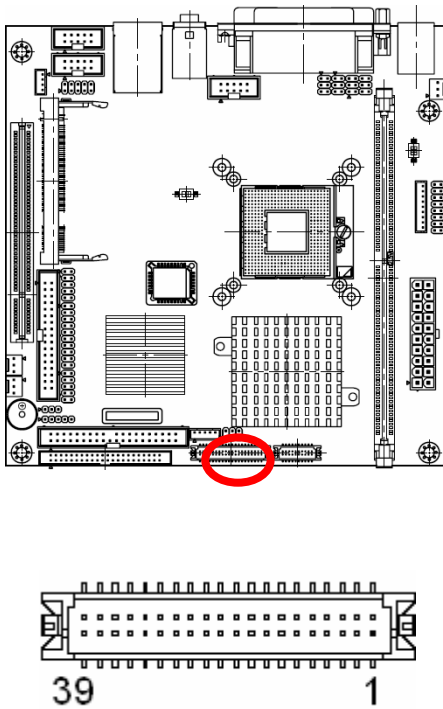

Signal	PIN	PIN	Signal
+5V	2	1	+3.3V
+5V	4	3	+3.3V
I ² C_DAT	6	5	I ² C_CLK
GND	8	7	GND
Txout0	10	9	Txout1
Txout0#	12	11	Txout1#
GND	14	13	GND
Txout2	16	15	Txout3
Txout2#	18	17	Txout3#
GND	20	19	GND
E_Txout0	22	21	E_Txout1
E_Txout0#	24	23	E_Txout1#
GND	26	25	GND
E_Txout2	28	27	E_Txout3
E_Txout2#	30	29	E_Txout3#
GND	32	31	GND
Txclk	34	33	E_Txclk
Txclk#	36	35	E_Txclk#
GND	38	37	GND
+12V	40	39	+12V

2.4.24.1 Signal Description – LVDS Connector (JLVDS1)

Signal	Signal Description
I ² C_DAT, I ² C_CLK	I ² C interface for panel parameter EEPROM. This EEPROM is mounted on the LVDS receiver. The data in the EEPROM allows the EXT module to automatically set the proper timing parameters for a specific LCD panel.

2.4.25 Miscellaneous Setting Connector (JMISC1)

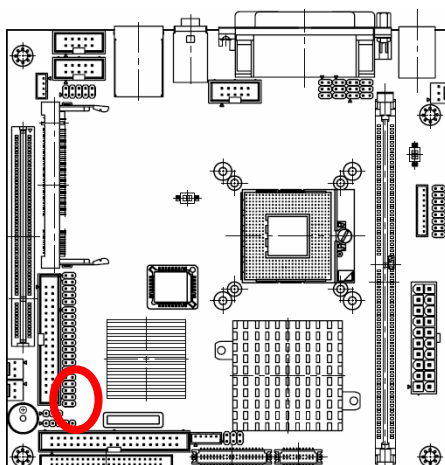

Signal	PIN	PIN	Signal
CASEOPEN#	1	2	VTIN3
GND	3	4	THRMDN
+5V	5	6	+5V
VR	7	8	#MASTER
GND	9	10	GND

2.4.25.1 Signal Description – Miscellaneous Setting Connector (JMISC1)

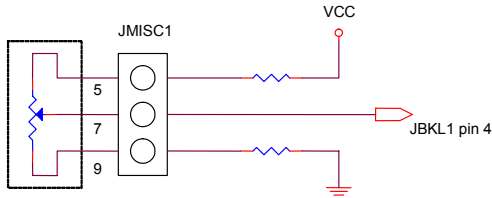
PIN No.	Description
1, 3	Case open detection
5, 7, 9	LCD brightness setting  <p>Variation Resistor (Recommended: 4.7KΩ, >1/16W)</p>
2, 4	Thermal detection
6, 8, 10	CF Master/Slave setting 8-10 short (default: Master)

AIMB-250 Series

2.4.26 TMD5 DVI Connector (JTMDS1)

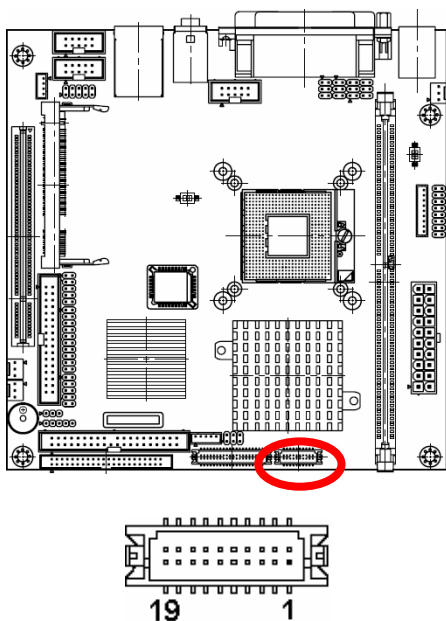

Signal	PIN	PIN	Signal
+5V	2	1	TDC0#
GND	4	3	TDC0
NC	6	5	NC
NC	8	7	NC
HPDET	10	9	TDC1#
TMDSDATA	12	11	TDC1
TMDSDCLK	14	13	NC
GND	16	15	NC
TLC#	18	17	TDC2#
TLC	20	19	TDC2

2.4.26.1 Signal Description – TMD5 Connector (JTMDS1)

Signal	Type	Signal Description
TDC0, TDC0#	O	DVI Data Channel 0 Outputs: These pins provide the DVI differential outputs for data channel 0 (blue).
TDC1, TDC1#	O	DVI Data Channel 1 Outputs: These pins provide the DVI differential outputs for data channel 1 (green).
TDC2, TDC2#	O	DVI Data Channel 2 Outputs: These pins provide the DVI differential outputs for data channel 2 (red).
HPDET	I	Hot Plug Detect (internal pull-down): This input pin determines whether the DVI is connected to a DVI monitor. When terminated, the monitor is required to apply a voltage greater than 2.4 volts. Changes on the status of this pin will be relayed to the graphics controller via the P-OUT/TLDET* or GPIO (1)/TLDET* pin pulling low.
TMDSDATA	I/O	DVO I2C Data: This signal is used as the I2C_DATA for a digital display (i.e. TV-Out Encoder, TMDS transmitter). This signal is tri-stated during a hard reset.
TMDSDCLK	I/O	DVI DDC Clock: This signal is used as the DDC clock for a digital display connector (i.e. primary digital monitor). This signal is tri-stated during a hard reset.
TLC, TLC#	O	DVI Clock Outputs: These pins provide the differential clock outputs for the DVI interface corresponding to data on TDC (0:2) outputs.

2.4.27 TV Out Connector (JTV1)

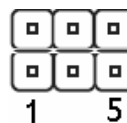
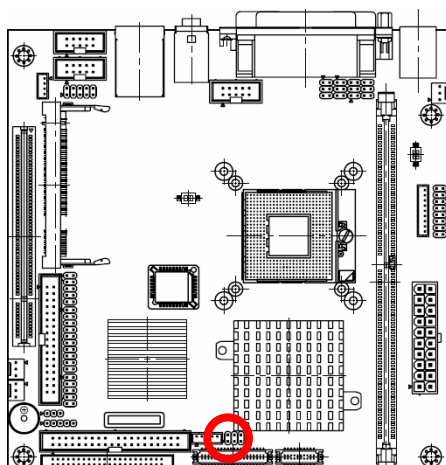

Signal	PIN	PIN	Signal
TVCVB	1	2	GND
TVYFCC2	3	4	TVCFCC2
GND	5	6	GND

2.4.27.1 Signal Description – TV Out Connector (JTV1)

Signal	Signal Description
TVYFCC2	Luma / Green Output. This pin outputs a selectable video signal. The output is designed to drive a 75 ohm doubly terminated load. The output can be selected to be S-video luminance or green.
TVCFCC2	Chroma / Green Output. This pin outputs a selectable video signal. The output is designed to drive a 75 ohm doubly terminated load. The output can be selected to be S-video chrominance or red
TVCVB	Composite Video / Blue Output. Chroma / Green Output. This pin outputs a selectable video signal. The output is designed to drive a 75 ohm doubly terminated load. The output can be selected to be composite video or blue.

AIMB-250 Series

2.4.28 USB Connector 2 & 3 (JUSB1)

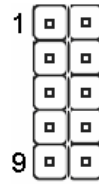
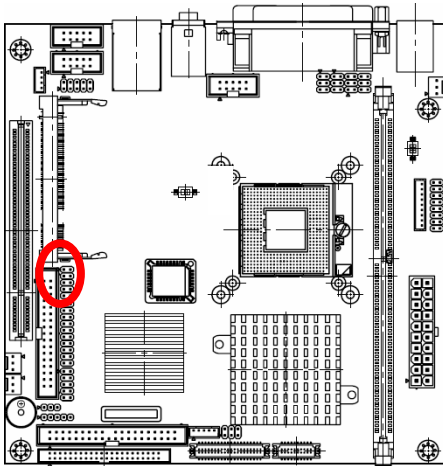

Signal	PIN	PIN	Signal
+5V	1	2	GND
D2-	3	4	GND
D2+	5	6	D3+
GND	7	8	D3-
GND	9	10	+5V

2.4.29 USB Connector 4 & 5 (JUSB2)

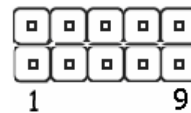
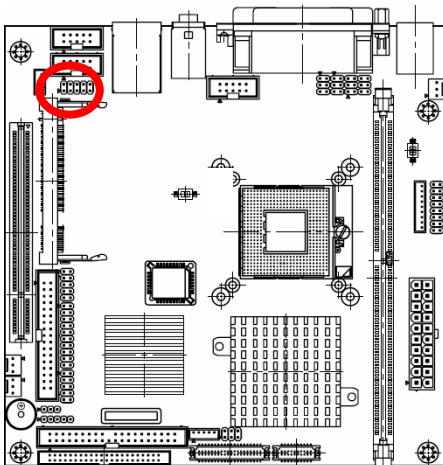

Signal	PIN	PIN	Signal
+5V	1	2	GND
D4-	3	4	GND
D4+	5	6	D5+
GND	7	8	D5-
GND	9	10	+5V

2.4.29.1 Signal Description – USB Connector 2, 3, 4 & 5 (JUSB1, JUSB2)

Signal	Signal Description
D2+/D2-	Differential bi-directional data signal for USB channel 2. Clock is transmitted along with the data using NRZI encoding. The signalling bit rate is up to 12 Mbs.
D3+/D3-	Differential bi-directional data signal for USB channel 3. Clock is transmitted along with the data using NRZI encoding. The signalling bit rate is up to 12 Mbs.
D4+/D4-	Differential bi-directional data signal for USB channel 4. Clock is transmitted along with the data using NRZI encoding. The signalling bit rate is up to 12 Mbs.
D5+/D5-	Differential bi-directional data signal for USB channel 5. Clock is transmitted along with the data using NRZI encoding. The signalling bit rate is up to 12 Mbs.

2.4.30 PS/2 Keyboard & Mouse Connector (KB_MS1)

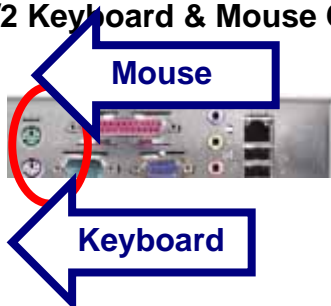

Port	Description
Mouse	PS/2 Mouse connector
Keyboard	PS/2 Keyboard connector

2.4.31 System Fan Connector 1 & 2 (S_FAN1, S_FAN2)

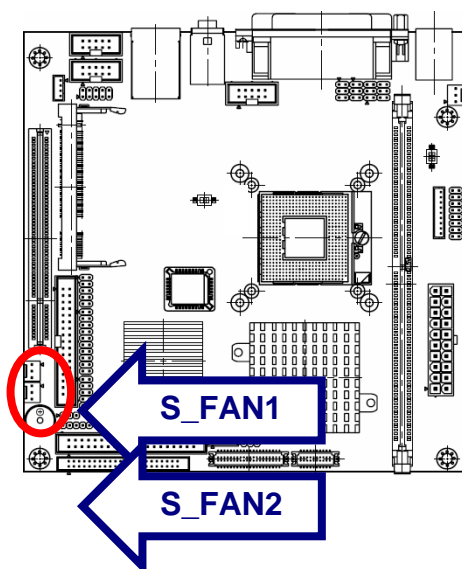

Signal	PIN
TAC	3
+12V	2
GND	1

2.4.31.1 Signal Description – System Fan Connector (S_FAN1, S_FAN2)

Signal	Signal Description
TAC	Fan speed monitor

3 BIOS Setup

3.1 Starting Setup

The AwardBIOS™ is immediately activated when you first power on the computer. The BIOS reads the system information contained in the CMOS and begins the process of checking out the system and configuring it. When it finishes, the BIOS will seek an operating system on one of the disks and then launch and turn control over to the operating system.

While the BIOS is in control, the Setup program can be activated in one of two ways:

By pressing immediately after switching the system on, or

By pressing the key when the following message appears briefly at the bottom of the screen during the POST (Power On Self Test).

Press DEL to enter SETUP

If the message disappears before you respond and you still wish to enter Setup, restart the system to try again by turning it OFF then ON or pressing the "RESET" button on the system case. You may also restart by simultaneously pressing <Ctrl>, <Alt>, and <Delete> keys. If you do not press the keys at the correct time and the system does not boot, an error message will be displayed and you will again be asked to.

Press F1 to Continue, DEL to enter SETUP

3.2 Using Setup

In general, you use the arrow keys to highlight items, press <Enter> to select, use the PageUp and PageDown keys to change entries, press <F1> for help and press <Esc> to quit. The following table provides more detail about how to navigate in the Setup program using the keyboard.

Button	Description
	Move to previous item
	Move to next item
	Move to the item in the left hand
	Move to the item in the right hand
Esc key	Main Menu -- Quit and not save changes into CMOS Status Page Setup Menu and Option Page Setup Menu -- Exit current page and return to Main Menu
PgUp key	Increase the numeric value or make changes
PgDn key	Decrease the numeric value or make changes
+ key	Increase the numeric value or make changes
- key	Decrease the numeric value or make changes
F1 key	General help, only for Status Page Setup Menu and Option Page Setup Menu
(Shift) F2 key	Change color from total 16 colors. F2 to select color forward, (Shift) F2 to select color backward
F3 key	Calendar, only for Status Page Setup Menu
F4 key	Reserved
F5 key	Restore the previous CMOS value from CMOS, only for Option Page Setup Menu
F6 key	Load the default CMOS value from BIOS default table, only for Option Page Setup Menu
F7 key	Load the default
F8 key	Reserved
F9 key	Reserved
F10 key	Save all the CMOS changes, only for Main Menu

- **Navigating Through The Menu Bar**

Use the left and right arrow keys to choose the menu you want to be in.



Note: Some of the navigation keys differ from one screen to another.

- **To Display a Sub Menu**

Use the arrow keys to move the cursor to the sub menu you want. Then press <Enter>. A “>” pointer marks all sub menus.

3.3 Getting Help

Press F1 to pop up a small help window that describes the appropriate keys to use and the possible selections for the highlighted item. To exit the Help Window press <Esc> or the F1 key again.

3.4 In Case of Problems

If, after making and saving system changes with Setup, you discover that your computer no longer is able to boot, the AwardBIOS™ supports an override to the CMOS settings which resets your system to its defaults.

The best advice is to only alter settings which you thoroughly understand. To this end, we strongly recommend that you avoid making any changes to the chipset defaults. These defaults have been carefully chosen by both Award and your systems manufacturer to provide the absolute maximum performance and reliability. Even a seemingly small change to the chipset setup has the potential for causing you to use the override.

3.5 Main Menu

Once you enter the AwardBIOS™ CMOS Setup Utility, the Main Menu will appear on the screen. The Main Menu allows you to select from several setup functions and two exit choices. Use the arrow keys to select among the items and press <Enter> to accept and enter the sub-menu.

Note that a brief description of each highlighted selection appears at the bottom of the screen.

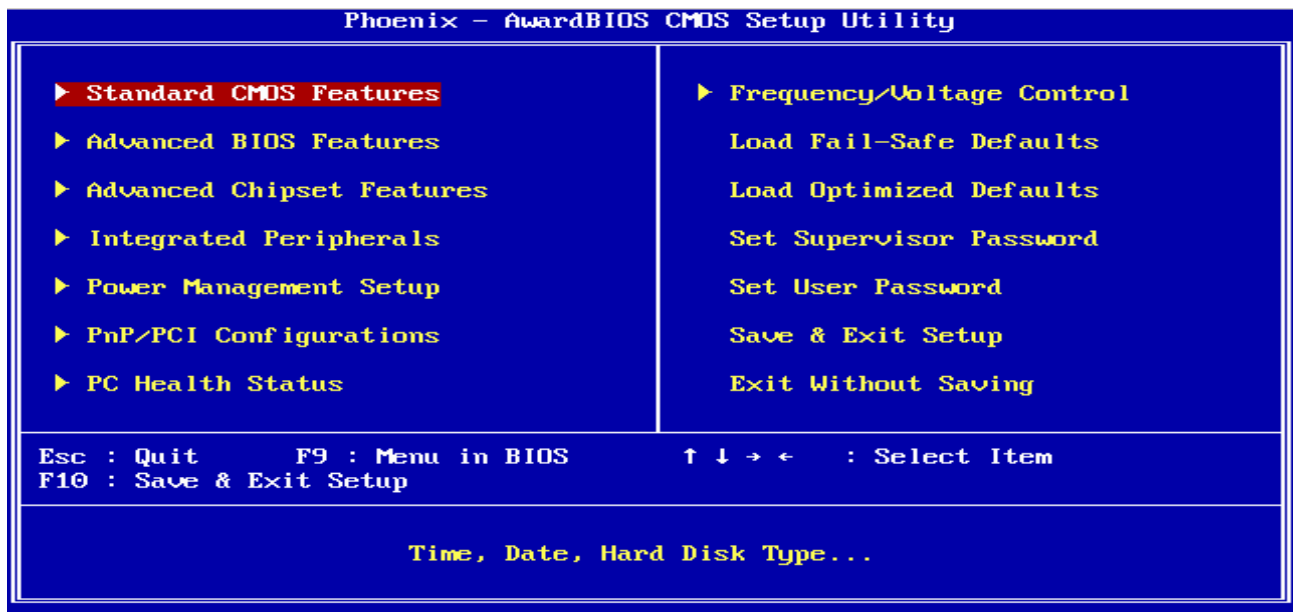

Note: The BIOS setup screens shown in this chapter are for reference purposes only, and may not exactly match what you see on your screen. Visit the Advantech website (www.Advantech.com.tw) to download the latest product and BIOS information.

3.5.1 Standard CMOS Features

The items in Standard CMOS Setup Menu are divided into few categories. Each category includes no, one or more than one setup items. Use the arrow keys to highlight the item and then use the <PgUp> or <PgDn> keys to select the value you want in each item.

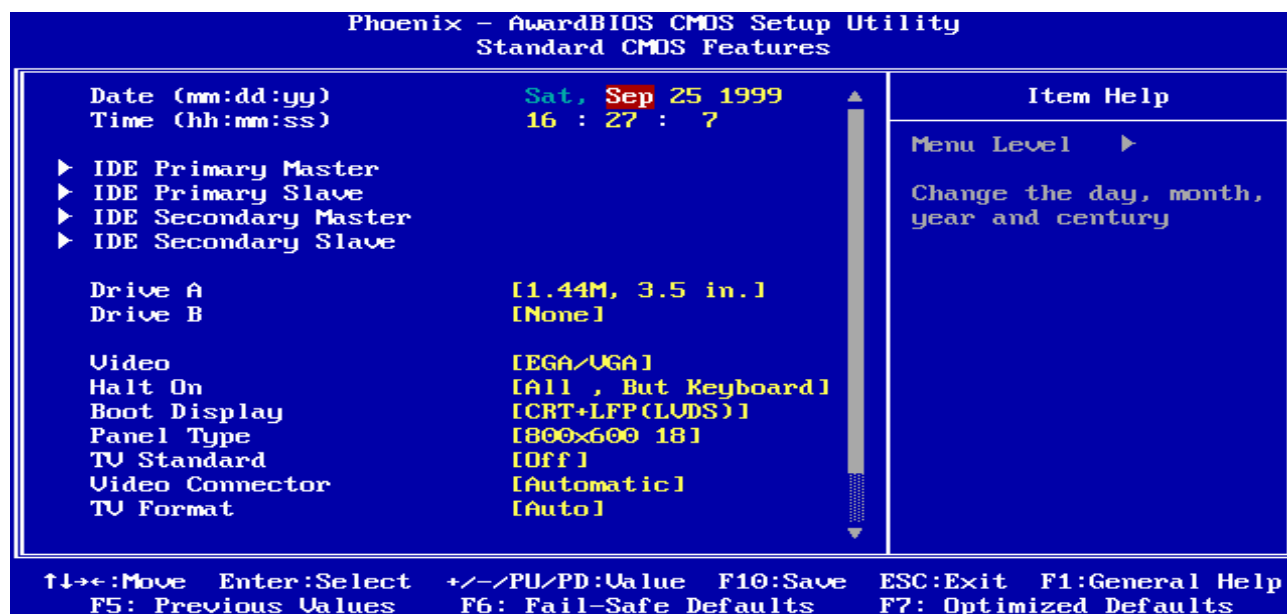

3.5.1.1 Main Menu Selection

This reference table shows the selections that you may make on the Main Menu.

Item	Options	Description
Time	HH : MM : SS	Set the system time
IDE Primary Master IDE Primary Slave IDE Secondary Master IDE Secondary Slave	Options are in 3.5.1.2	Press <Enter> to enter the sub menu of detailed options
Drive A Drive B	None 360K, 5.25 in 1.2M, 5.25 in 720K, 3.5 in 1.44M, 3.5 in 2.88M, 3.5 in	Select the type of floppy disk drive installed in your system
Video	EGA/VGA CGA 40 CGA 80 MONO	Select the default video device
Halt On	All Errors No Errors All, but Keyboard All, but Diskette All, but Disk/Key	Select the situation in which you want the BIOS to stop the POST process and notify you
Boot Display	CRT LFP (LVDS) CRT+LFP(LVDS) EFP(PANEL-LINK) TV CRT+EFP	Select Display Device that the screen will be shown

AIMB-250 Series

Item	Options	Description
Panel Type	640 x 480 18 800 x 600 18 1024 x 768 18 1280 x 1024 24/2 1400 x 1050 24 1600 x 1200 24 1280 x 768 24 1680 x 1050 24 1920 x 1200 24 1024 x 768 24 1024 x 768 18/2 1024 x 768 24/2 1280 x 800 18 1280 x 600 18	Select Panel Resolution that will be displayed depending on the LCD Panel (LFP)
TV Standard	Off, NTSC PAL, SECAM	Select the output mode of TV Standard
Video Connector	Automatic, Composite Component, Both	Select the type of Video display connector
TV Format	Auto, NTSC_M, NTSC_M_J, NTSC_433, NTSC_N, PAL_B, PAL_G, PAL_D, PAL_H, PAL_I, PAL_M, PAL_N, PAL_60, SECAM_L, SECAM_L1, SECAM_B, SECAM_D, SECAM_G, SECAM_H, SECAM_K, SECAM_K1	This item allows you to select different TV signal format when the TV Standard item is not off.

3.5.1.2 IDE Adapter Setup

The IDE adapters control the hard disk drive. Use a separate sub menu to configure each hard disk drive. The below table will shows the IDE primary master sub menu.

Item	Options	Description
IDE HDD Auto-detection	Press Enter	Press Enter to auto-detect the HDD on this channel. If detection is successful, it fills the remaining fields on this menu.
IDE Primary Master IDE Primary Slave, IDE Secondary Master, IDE Secondary Slave	None Auto Manual	Selecting 'manual' lets you set the remaining fields on this screen. Selects the type of fixed disk. "User Type" will let you select the number of cylinders, heads, etc. Note: PRECOMP=65535 means NONE !
Access Mode	CHS, LBA Large, Auto	Choose the access mode for this hard disk
The following options are selectable only if the 'IDE Channel ...' item is set to 'Manual'		
Cylinder	Min = 0 Max = 65535	Set the number of cylinders for this hard disk.
Head	Min = 0 Max = 255	Set the number of read/write heads
Precomp	Min = 0 Max = 65535	**** Warning: Setting a value of 65535 means no hard disk
Landing zone	Min = 0 Max = 65535	****
Sector	Min = 0 Max = 255	Number of sectors per track

3.5.2 Advanced BIOS Features

This section allows you to configure your system for basic operation. You have the opportunity to select the system's default speed, boot-up sequence, keyboard operation, shadowing and security.

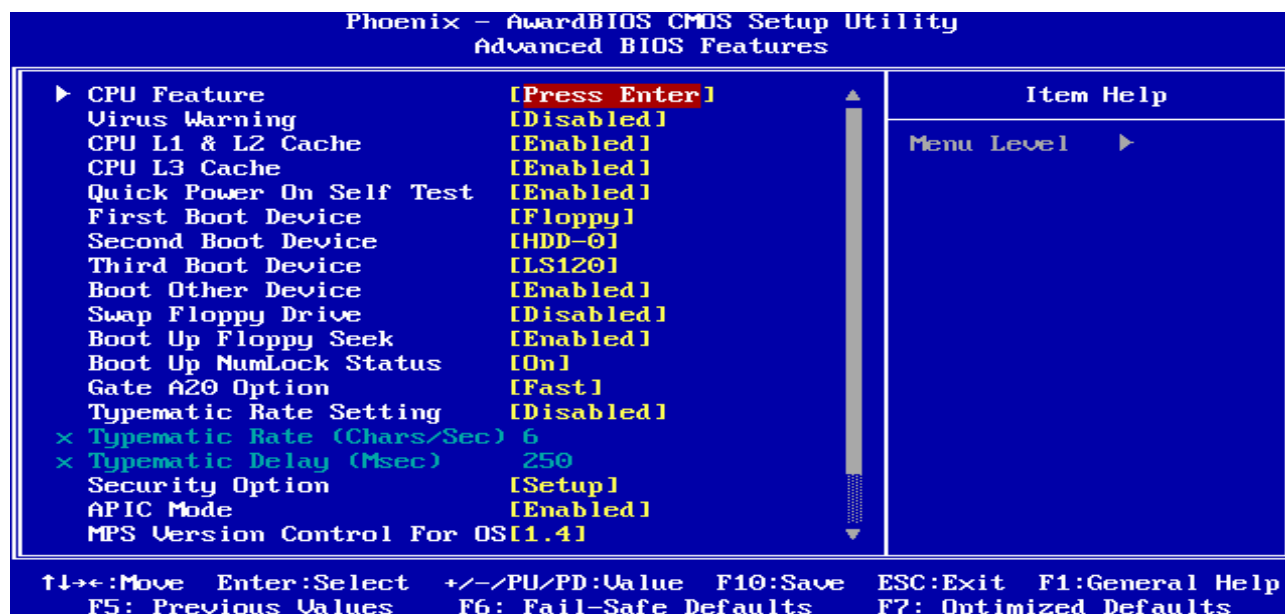

3.5.2.1 CPU Feature

This item allows you to setup the CPU thermal management function.

Item	Options	Description
Thermal Management	Thermal Monitor 1 Thermal Monitor 2	
TM2 Bus VID	0.700 ~ 1.708	
Execute Disable Bit	Enabled, Disabled	

3.5.2.2 Virus Warning

Allows you to choose the VIRUS Warning feature for IDE Hard Disk boot sector protection. If this function is enabled and someone attempt to write data into this area, BIOS will show a warning message on screen and alarm beep.

Item	Description
Enabled	Activates automatically when the system boots up causing a warning message to appear when anything attempts to access the boot sector or hard disk partition table.
Disabled	No warning message will appear when anything attempts to access the boot sector or hard disk partition table.

3.5.2.3 CPU L1 & L2 & L3 Cache

The item allows you to speed up memory access. However, it depends on CPU design.

Item	Description
Enabled	Enable cache
Disabled	Disable cache

3.5.2.4 Quick Power On Self Test

This category speeds up Power On Self Test (POST) after you power up the computer. If it is set to Enable, BIOS will shorten or skip some check items during POST.

Item	Description
Enabled	Enable quick POST
Disabled	Normal POST

AIMB-250 Series

3.5.2.5 First/Second/Third/Other Boot Device

The BIOS attempts to load the operating system from the devices in the sequence selected in these items.

Item	Description
Floppy	Floppy Device
LS120	LS120 Device
HDD-0~4	Hard Disk Device 0, 1, 2, 3, 4
SCSI	SCSI Device
CDROM	CDROM Device
ZIP100	ZIP-100 Device
USB-FDD	USB Floppy Device
USB-ZIP	USB ZIP Device
USB-CDROM	USB CDROM Device
USB-HDD	USB Hard Disk Device
LAN	Network Device
Disabled	Disabled any boot device

3.5.2.6 Swap Floppy Drive

While system has two floppy drivers installed, this item will be affected. This function is to assign physical drive B to logical drive A.

Item	Description
Enabled	Assign physical drive B to logical drive A
Disabled	No change

3.5.2.7 Book Up Floppy Seek

Seeks disk drives during boot up. Disabling seeds boot up.

Item	Description
Enabled	Enable Floppy Seek
Disabled	Disable Floppy Seek

3.5.2.8 Boot Up NumLock Status

Select power on state for NumLock.

Item	Description
Enabled	Enable NumLock
Disabled	Disable NumLock

3.5.2.9 Gate A20 Option

Select if chipset or keyboard controller should control Gate A20.

Item	Description
Normal	A pin in the keyboard controller controls Gate A20
Fast	Lets chipset control Gate A20

3.5.2.10 Typematic Rate Setting

Key strokes repeat at a rate determined by the keyboard controller. When enabled, the typematic rate and typematic delay can be selected.

Item	Description
Enabled	Enable typematic rate/delay setting
Disabled	Disable typematic rate/delay setting

3.5.2.11 Security Option

Select whether the password is required every time the system boots or only when you enter setup.

Item	Description
System	The system will not boot and access to Setup will be denied if the correct password is not entered at the prompt.
Setup	The system will boot, but access to Setup will be denied if the correct password is not entered at the prompt.



Note: To disable security, select PASSWORD SETTING at Main Menu and then you will be asked to enter password. Do not type anything and just press <Enter>, it will disable security. Once the security is disabled, the system will boot and you can enter Setup freely.

3.5.2.12 APIC Mode

The BIOS supports versions 1.4 of the Intel multiprocessor specification. When enabled, The MPS Version 1.4 Control for OS can be activated.

The choice: Enabled/Disabled.

3.5.2.13 MPS Version Control For OS

This feature is only applicable to multiprocessor board as it specifies the version of the Multi-Processor Specification (MPS) that the board will use.

The choice: 1.4, 1.1.

3.5.2.14 OS Select for DRAM > 64MB

Select the operating system that is running with greater than 64MB of RAM on the system.

Item	Description
Non-OS2	Disable OS for over 64 MB DRAM
OS2	Enable OS for over 64 MB DRAM

3.5.2.15 Report No FDD For WIN95

The original Windows95 requires the presence of a floppy. Unless the BIOS tells it to disregard the absence of the drive, it will generate an error message. For other operating systems as Win98 etc this field is without relevance.

Item	Description
No	Don't generate error message
Yes	Generate error message

3.5.2.16 Full Screen LOGO Show

This item allows to enabled/disabled the full screen logo during BIOS boot up process.

Item	Description
Enabled	Full Screen Logo show is enabled
Disabled	Full Screen Logo show is disabled

3.5.2.17 Logo (EPA) Show

This item allows you enabled/disabled the small EPA logo show on screen at the POST step.

Item	Description
Enabled	EPA Logo show is enabled
Disabled	EPA Logo show is disabled

AIMB-250 Series

3.5.3 Advanced Chipset Features

This section allows you to configure the system based on the specific features of the installed chipset. This chipset manages bus speeds and access to system memory resources, such as DRAM and the external cache. It also coordinates communications between the conventional ISA bus and the PCI bus. It must be stated that these items should never need to be altered. The default settings have been chosen because they provide the best operating conditions for your system. The only time you might consider making any changes would be if you discovered that data was being lost while using your system.

The first chipset settings deal with CPU access to dynamic random access memory (DRAM). The default timings have been carefully chosen and should only be altered if data is being lost. Such a scenario might well occur if your system had mixed speed DRAM chips installed so that greater delays may be required to preserve the integrity of the data held in the slower memory chips.

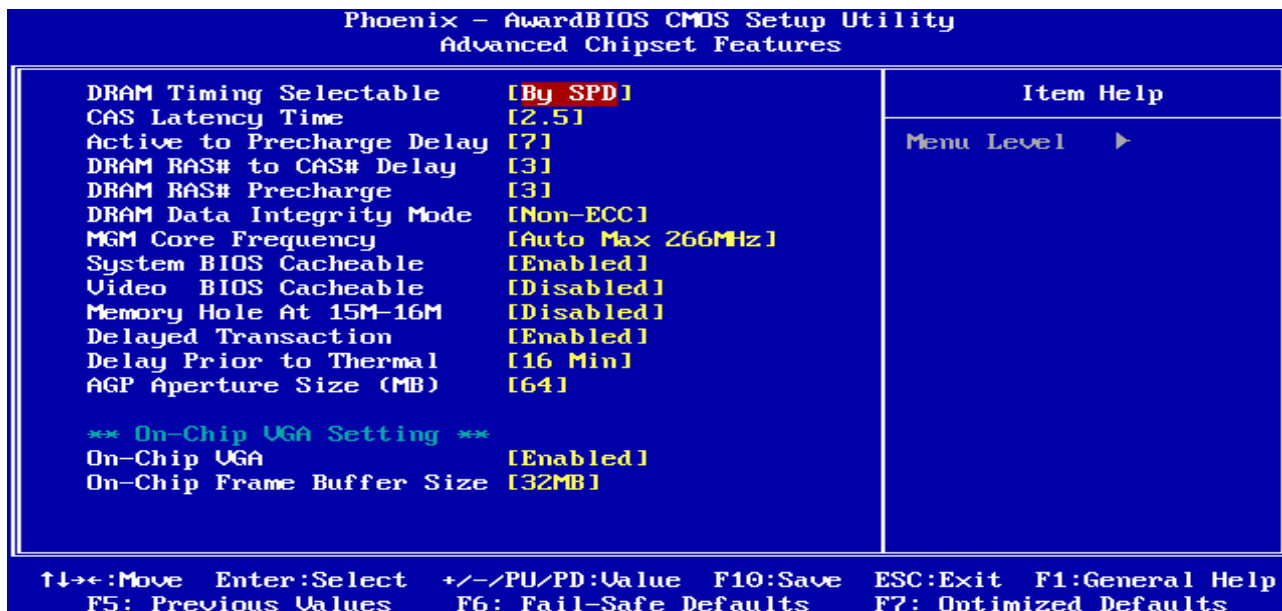

3.5.3.1 DRAM Timing Selectable

This item allows you to select the DRAM timing value by SPD data or Manual by yourself. The choices: Manual, By SPD.

3.5.3.2 CAS Latency Time

This item controls the time delay (in clock cycles - CLKs) that passes before the SDRAM starts to carry out a read command after receiving it. This also determines the number of CLKs for the completion of the first part of a burst transfer. In other words, the lower the latency, the faster the transaction.

The choices: 2, 2.5.

3.5.3.3 Active to Precharge Delay

This item is the minimum delay time between Active and Precharge

The choices: 5, 6, 7.

3.5.3.4 DRAM RAS# to CAS# Delay

This option allows you to insert a delay between the RAS (**Row Address Strobe**) and CAS (**Column Address Strobe**) signals. This delay occurs when the SDRAM is written to, read from or refreshed. Naturally, reducing the delay improves the performance of the SDRAM while increasing it reduces performance.

The choices: 2, 3.

3.5.3.5 DRAM RAS# Precharge

This option sets the number of cycles required for the RAS to accumulate its charge before the SDRAM refreshes. Reducing the precharge time to **2** improves SDRAM performance but if the precharge time of **2** is insufficient for the installed SDRAM, the SDRAM may not be refreshed properly and it may fail to retain data

So, for better SDRAM performance, set the **SDRAM RAS Precharge Time** to **2** but increase it to **3** if you face system stability issues after reducing the precharge time.

The choices: 2, 3.

3.5.3.6 DRAM Data Integrity Mode

Select ECC if your memory module supports it. The memory controller will detect and correct single-bit soft memory errors. The memory controller will also be able to detect double-bit errors though it will not be able to correct them. This provides increased data integrity and system stability.

The choices: Non-ECC, ECC.

3.5.3.7 MGM Core Frequency

This field sets the frequency of the DRAM memory installed.

The choices: Auto Max 266MHz, 400/266/133/200 MHz, 400/200/100/200 MHz, 400/200/100/133 MHz, 400/266/133/267 MHz, 533/266/133/200 MHz, 533/266/133/266 MHz, 400/333/166/250 MHz, Auto Max 400/333 MHz, Auto Max 533/333 MHz.

3.5.3.8 System BIOS Cacheable

This feature is only valid when the system BIOS is shadowed. It enables or disables the caching of the system BIOS ROM at **F0000h-FFFFFh** via the L2 cache. This greatly speeds up accesses to the system BIOS. However, this does **not** translate into better system performance because the OS does not need to access the system BIOS much.

The choices: Disabled, Enabled.

3.5.3.9 Video BIOS Cacheable

This feature is only valid when the video BIOS is shadowed. It enables or disables the caching of the video BIOS ROM at **C0000h-C7FFFh** via the L2 cache. This greatly speeds up accesses to the video BIOS. However, this does **not** translate into better system performance because the OS bypasses the BIOS using the graphics driver to access the video card's hardware directly.

The Choice: Enabled, Disabled.

AIMB-250 Series

3.5.3.10 Memory Hole At 15M-16M

Enabling this feature reserves 15MB to 16MB memory address space to ISA expansion cards that specifically require this setting. This makes the memory from 15MB and up unavailable to the system. Expansion cards can only access memory up to 16MB.

The choice: Enable, Disable.

3.5.3.11 Delayed Transaction

This feature is used to meet the latency of PCI cycles to and from the ISA bus. The ISA bus is much, much slower than the PCI bus. Thus, PCI cycles to and from the ISA bus take a longer time to complete and this slows the PCI bus down.

However, enabling **Delayed Transaction** enables the chipset's embedded 32-bit posted write buffer to support delayed transaction cycles. This means that transactions to and from the ISA bus are buffered and the PCI bus can be freed to perform other transactions while the ISA transaction is underway.

This option should be **enabled** for better performance and to meet PCI 2.1 specifications. Disable it only if your PCI cards cannot work properly or if you are using an ISA card that is not PCI 2.1 compliant.

The Choice: Enabled, Disabled.

3.5.3.12 Delay Prior to Thermal

When your system temperature is higher, you can set the DRAM access time slowdown between on 4 min – 32 min delay.

The choice: 4 Min, 8 Min, 16 Min, and 32 Min.

3.5.3.13 AGP Aperture Size (MB)

Select the size of Accelerated Graphics Port (AGP) aperture. The aperture is a portion of the PCI memory address range dedicated for graphics memory address space. Host cycles that hit the aperture range are forwarded to the AGP without any translation.

The Choice: 4, 8, 16, 32, 64, 128, 256.

3.5.3.14 Init Display First

This item allows you to decide to active whether PCI Slot or Onboard/AGP first.

The choice: PCI Slot, Onboard/AGP.

3.5.3.15 On-Chip VGA

This item is enabled as the onboard VGA is used.

The Choices: Enabled, Disabled.

3.5.3.16 On-Chip Frame Buffer Size

This item is to select the amount of system memory that will be utilized as internal graphics device memory

The choices: 1MB, 4MB, 8MB, 16MB, 32MB.

3.5.4 Integrated Peripherals

Use this menu to specify your settings for integrated peripherals.

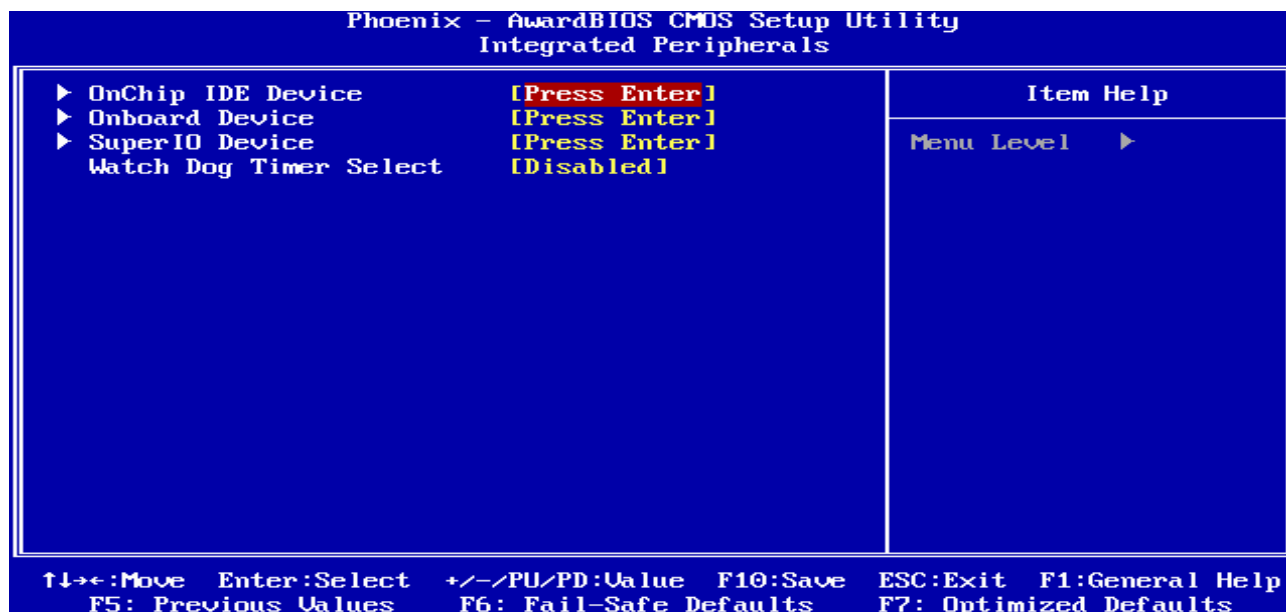

3.5.4.1 OnChip IDE Device

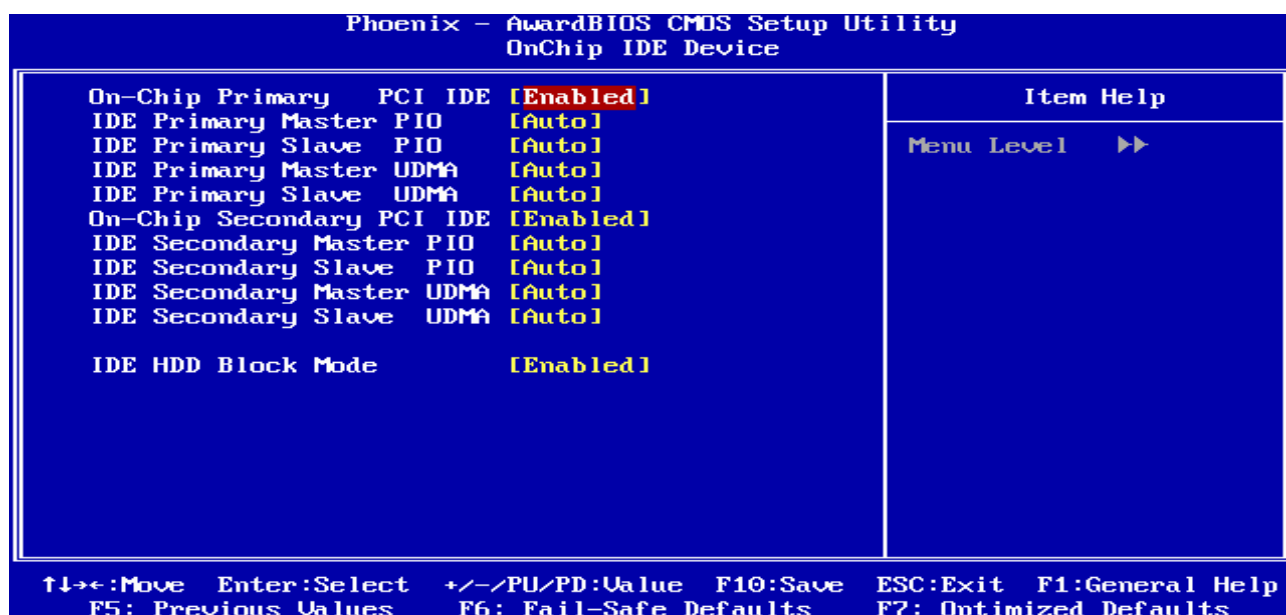

The chipset contains a PCI IDE interface with support for two IDE channels. Select Enabled to activate the primary IDE interface. Select Disabled to deactivate this interface.

AIMB-250 Series

Item	Options	Description
On-Chip Primary PCI IDE On-Chip Secondary PCI IDE	Enabled Disabled	The chipset contains a PCI IDE interface with support for two IDE channels. Select Enabled to activate the primary/secondary IDE interface. Select Disabled to deactivate this interface.
IDE Primary Master PIO IDE Primary Slave PIO IDE Secondary Master PIO IDE Secondary Slave PIO	Auto Mode 0 Mode 1 Mode 2 Mode 3 Mode 4	The IDE PIO (Programmed Input/Output) fields let you set a PIO mode (0-4) for each of the four IDE devices that the onboard IDE interface supports. Modes 0 through 4 provide successively increased performance. In Auto mode, the system automatically determines the best mode for each device.
IDE Primary Master UDMA IDE Primary Slave UDMA IDE Secondary Master UDMA IDE Secondary Slave UDMA	Auto Disabled	Ultra DMA implementation is possible only if your IDE hard drive supports it and the operating environment includes a DMA driver (Windows 95 OSR2 or a third-party IDE bus master driver). If the hard drive and the system software both support Ultra DMA, select Auto to enable BIOS support.

3.5.4.2 Onboard Device

Phoenix – AwardBIOS CMDS Setup Utility
Onboard Device

USB Controller [Enabled] USB 2.0 Controller [Enabled] USB Keyboard Support [Disabled] USB Mouse Support [Disabled] AC97 Audio [Auto] Init Display First [Onboard/AGP]	Item Help Menu Level ▶▶
--	--------------------------------------

↑↓←→: Move Enter: Select +/-/PU/PD: Value F10: Save ESC: Exit F1: General Help
 F5: Previous Values F6: Fail-Safe Defaults F7: Optimized Defaults

Item	Options	Description
USB Controller	Enabled Disabled	This item allows you to set the USB Controller.
USB 2.0 Controller	Disabled Enabled	This item allows you to set the USB 2.0 Controller.
USB Keyboard Support	Enabled Disabled	This item allows you to set the system's USB keyboard to Enabled/Disabled.
USB Mouse Support	Enabled Disabled	This item allows you to set the system's USB Mouse to Enabled/Disabled.
AC97 Audio	Auto Disabled	This item allows you to decide to Auto/disable the Codec chip to support AC97 Audio.

3.5.4.3 Super IO Device

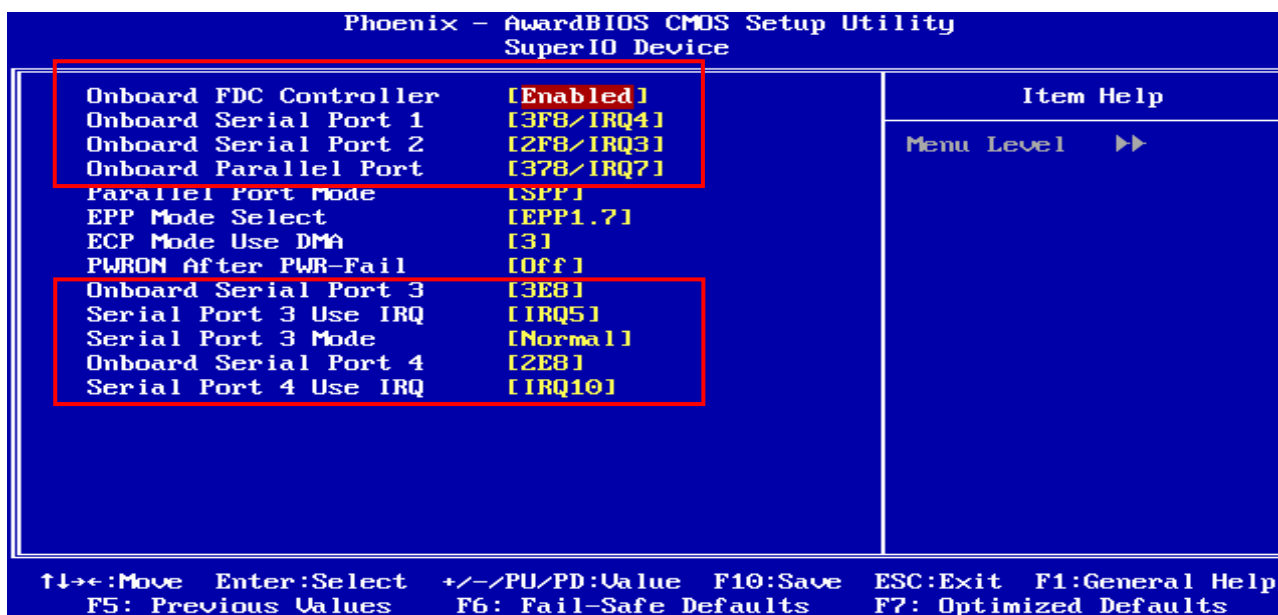

AIMB-250 Series

Item	Options	Description
Onboard FDC Controller	Enabled Disabled	Select Enabled if your system has a floppy disk controller (FDC) installed on the system board and you wish to use it. If you are not going to use FDC or the system has no floppy drive, select Disabled in this field.
Onboard Serial Port 1 Onboard Serial Port 2	Disable, 3F8/IRQ4 2F8/IRQ3, 3E8/IRQ4 2E8/IRQ3, AUTO	Select an address and corresponding interrupt for the first and second serial ports.
Onboard Parallel Port	Disabled, 378/IRQ7 278/IRQ5, 3BC/IRQ7	Select a matching address and interrupt for the physical parallel (printer) port.
Parallel Port Mode	SPP, EPP ECP, Normal ECP+EPP	Select an operating mode for the onboard parallel port. Select Compatible or Extended unless you are certain both your hardware and software support EPP or ECP mode.
EPP Mode Select	EPP1.9, EPP1.7	Select EPP port type 1.7 or 1.9.
ECP Mode Use DMA	1, 3	Select a DMA channel for the port.
PWRON After PWR-Fail	Off, On Former-Sts	This item is to set whether to run Ac Loss Auto Restart or off
Onboard Serial Port 3 Onboard Serial Port 4	Disable, 3F8 2F8, 3E8, 2E8	Select an IRQ address for the third and forth serial Ports.
Serial Port 3 Use IRQ Serial Port 4 Use IRQ	IRQ3, IRQ4, IRQ5 IRQ9, IRQ10, IRQ11	Select an IRQ for the third and forth serial ports.
Serial Port 3 Mode	Normal IRDA	Select an IO address for the third serial ports

3.5.4.4 Watch Dog Timer

This option will determine watch dog timer.

The choices: Disabled, 10, 20, 30, 40 Sec. 1, 2, 4 Min.

3.5.5 Power Management Setup

The Power Management Setup allows you to configure you system to most effectively save energy while operating in a manner consistent with your own style of computer use.

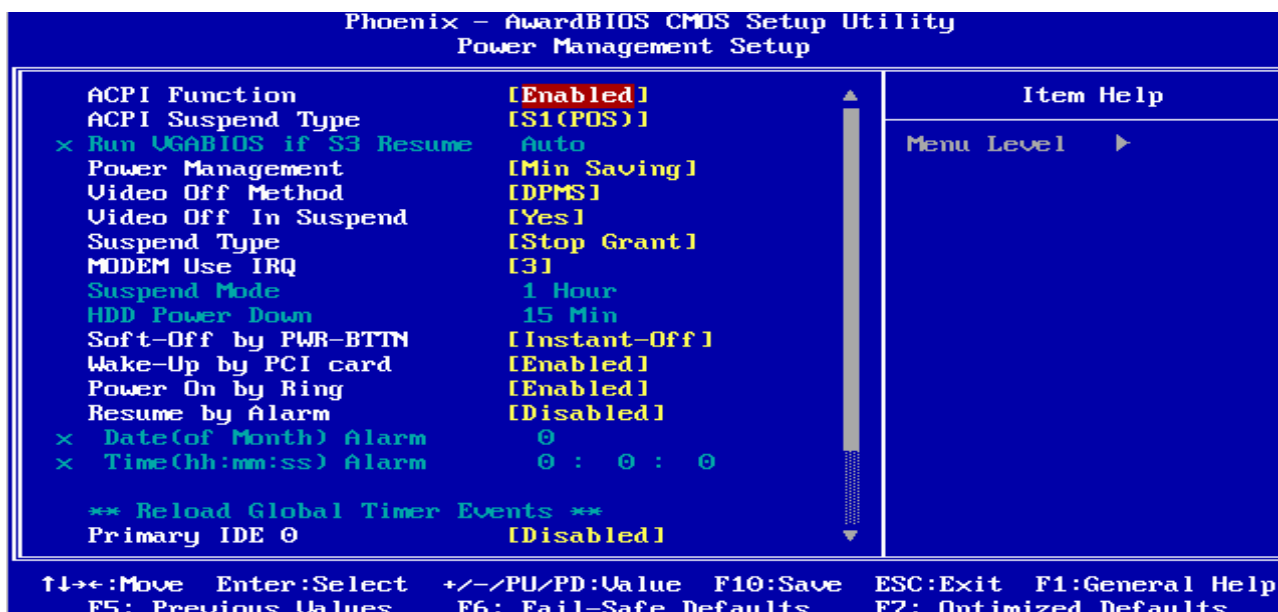

3.5.5.1 ACPI Function

This item allows you to enable/disable the ACPI function.

The choices: Enable, Disable.

3.5.5.2 ACPI Suspend Type

This item will set which ACPI suspend type will be used.

The choice: S1(POS), S3(STR).S1&S3.

3.5.5.3 Power Management

This category allows you to select the type (or degree) of power saving and is directly related to the following modes:

Item	Description
Min. Power Saving	Minimum power management, HDD Power Down = 15 Min,
Max. Power Saving	Maximum power management, HDD Power Down =1 Min,
User Defined	Allows you to set each mode individually. When not disabled, each of the ranges are from 1 min. to 1 hr. except for HDD Power Down which ranges from 1 min. to 15 min. and disable.

3.5.5.4 Video Off Method

This determines the manner in which the monitor is blanked.

The choices: Blank Screen, V/H SYNC+Blank, DPMS.

3.5.5.5 Video Off In Suspend

This determines the manner in which the monitor is blanked.

The choice: No, Yes.

3.5.5.6 Suspend Type

This function allows to select Suspend type.

The choices: Stop Grant, PwrOn Suspend.

AIMB-250 Series

3.5.5.7 MODEM Use IRQ

This determines the IRQ in which the MODEM can use.

The choices: NA, 3, 4, 5, 7, 9, 10, 11.

3.5.5.8 Soft-Off by PWR-BTTN

Pressing the power button for more than 4 seconds forces the system to enter the Soft-Off state when the system has "hung".(Only could working on ATX Power supply)

The choices: Delay 4 Sec, Instant-Off.

3.5.5.9 Wake Up by PCI Card

This will enable the system to wake up through PCI Card peripheral.

The choices: Enable, Disabled.

3.5.5.10 Power On By Ring

This determines whether the system boot up if there's an incoming call from the Modem.

The choices: Enable, Disabled.

3.5.5.11 Resume By Alarm

This function is for setting date and time for your computer to boot up.

The choices: Enabled, Disabled.

3.5.5.12 Primary/Secondary IDE 0/1, FDD,COM,LPT PORT, PCI PIRQ[A-D]#

Reload Global Timer events are I/O events whose occurrence can prevent the system from entering a power saving mode or can awake the system from such a mode. In effect ,the system remain alert for anything which occurs to a device which is configured as Enabled ,even when the system is in a power down mode.

The choices: Enabled, Disabled.

3.5.6 PnP / PCI Configuration

This section describes configuring the PCI bus system. PCI, or **P**ersonal **C**omputer **I**nterconnect, is a system which allows I/O devices to operate at speeds nearing the speed the CPU itself uses when communicating with its own special components. This section covers some very technical items and it is strongly recommended that only experienced users should make any changes to the default settings.

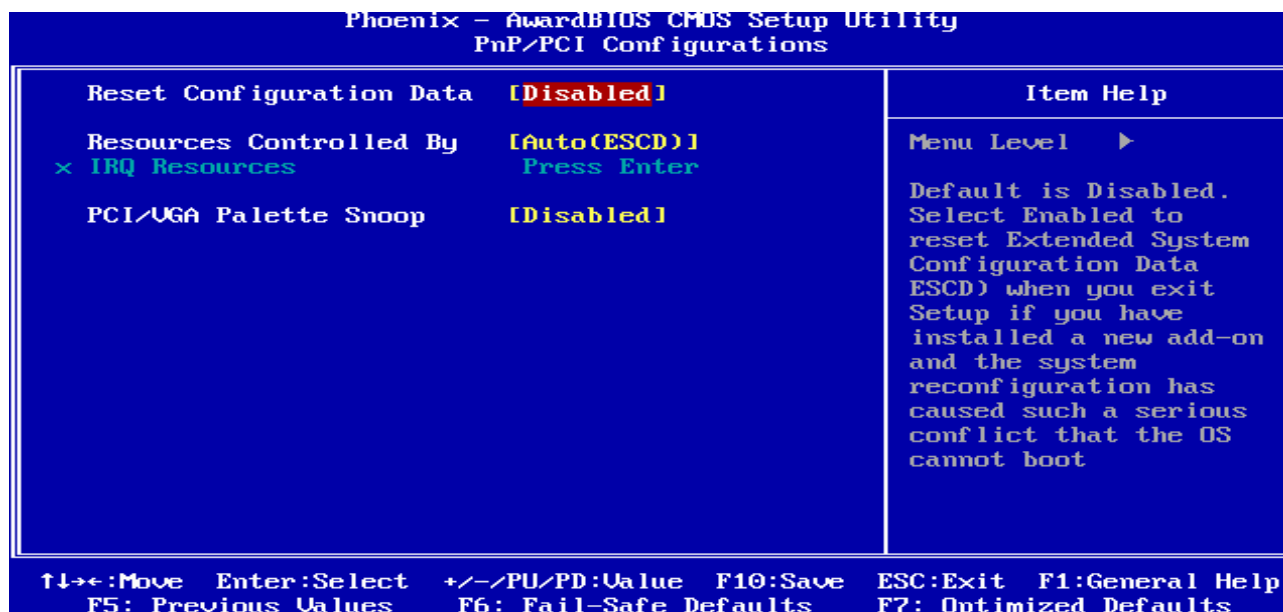

3.5.6.1 Reset Configuration Data

Normally, you leave this field Disabled. Select Enabled to reset Extended System Configuration Data (ESCD) when you exit Setup if you have installed a new add-on and the system reconfiguration has caused such a serious conflict that the operating system cannot boot.

The choices: Enabled, Disabled.

3.5.6.2 Resources Controlled By

The Award Plug and Play BIOS has the capacity to automatically configure all of the boot and Plug and Play compatible devices. However, this capability means absolutely nothing unless you are using a Plug and Play operating system such as Windows®95. If you set this field to "manual" choose specific resources by going into each of the sub menu that follows this field (a sub menu is preceded by a "➤").

The choices: Auto(ESCD), Manual.

3.5.6.3 PCI / VGA Palette Snoop

Leave this field at Disabled.

The choices: Enabled, Disabled.

AIMB-250 Series

3.5.7 PC Health Status

This section shows the status of your CPU, Fan & System.

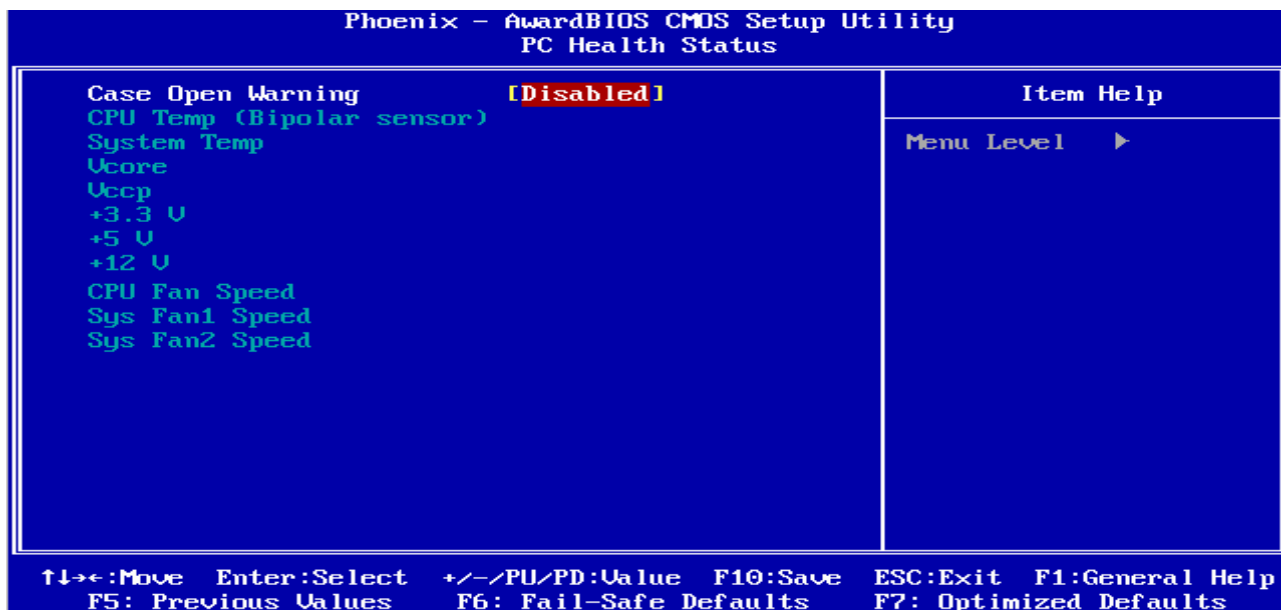

3.5.7.1 Case Open Warning

This item allows to enable the case open warning function.

The choices: Enabled, Disabled.

3.5.8 Frequency / Voltage Control

This menu specifies your setting for frequency/voltage control.

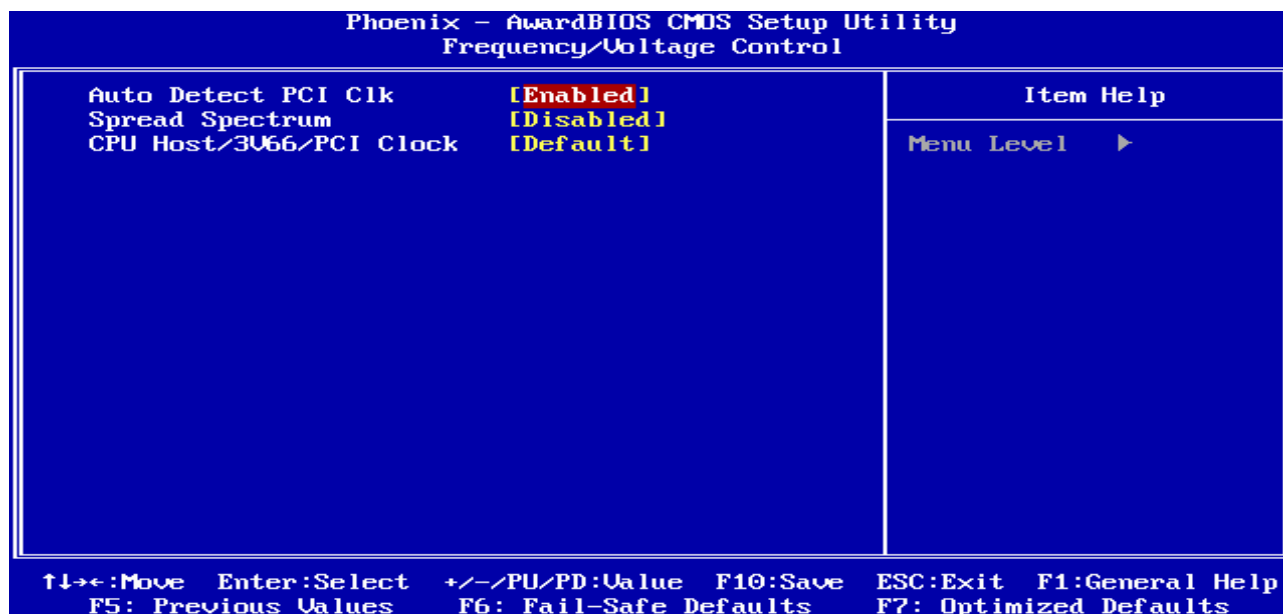

3.5.8.1 Auto Detect PCI Clk

This item allows you to enable/disable auto detect PCI Clock.

The choices: Enable, Disable.

3.5.8.2 Spread Spectrum

This item is to adjust extreme values of the pulse for EMI test.

The choices: Enable, Disable.

3.5.8.3 CPU Host / 3V66 / PCI Clock

These options allow you to set CPU Host/3V66/PCI clock into various types of frequencies.

The choices: Default, 100/66/33MHz, 105/70/35MHz, 109/73/36MHz, 114/76/38MHz, 117/78/39MHz, 127/85/42MHz, 130/87/43MHz, 133/67/33MHz, 137/69/34MHz, 141/71/35MHz, 145/73/36MHz, 150/75/38MHz, 155/78/39MHz, 160/80/40MHz.

AIMB-250 Series

3.5.9 Load Fail-Safe Defaults

Use this menu to load the BIOS default values for the minimal/stable performance for your system to operate.

Press <Y> to load the BIOS default values for the most stable, minimal-performance system operations.

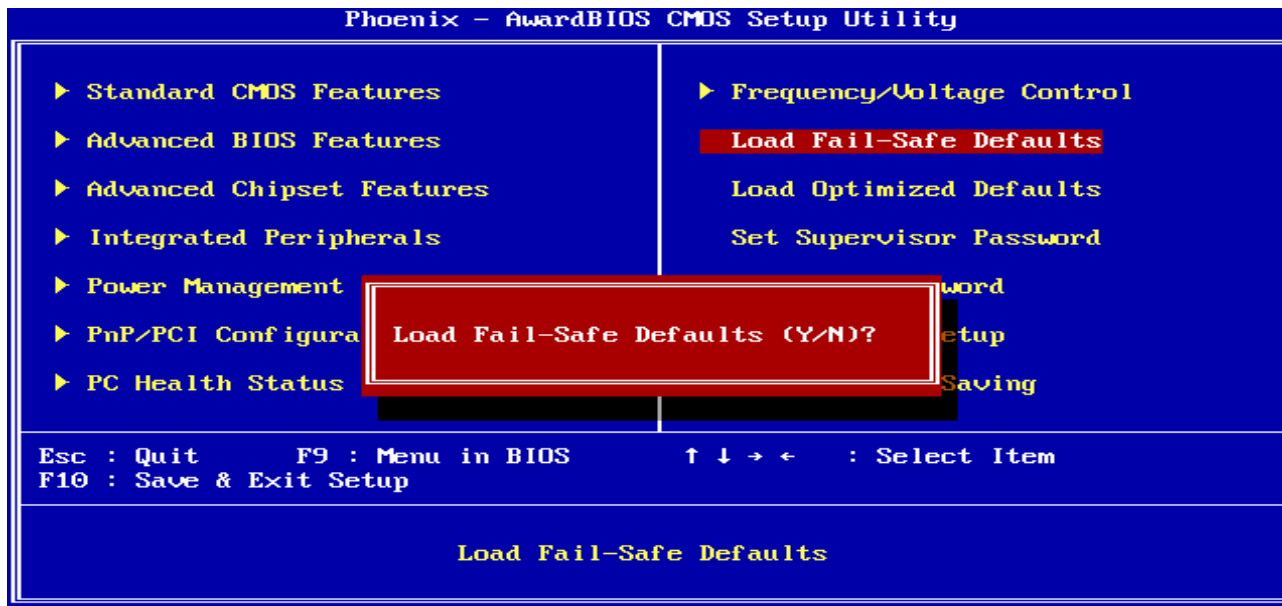

3.5.10 Load Optimized Defaults

Use this menu to load the BIOS default values that are factory settings for optimal performance system operations. While Award has designed the custom BIOS to maximize performance, the factory has the right to change these defaults to meet their needs.

Press <Y> to load the default values setting for optimal performance system operations.

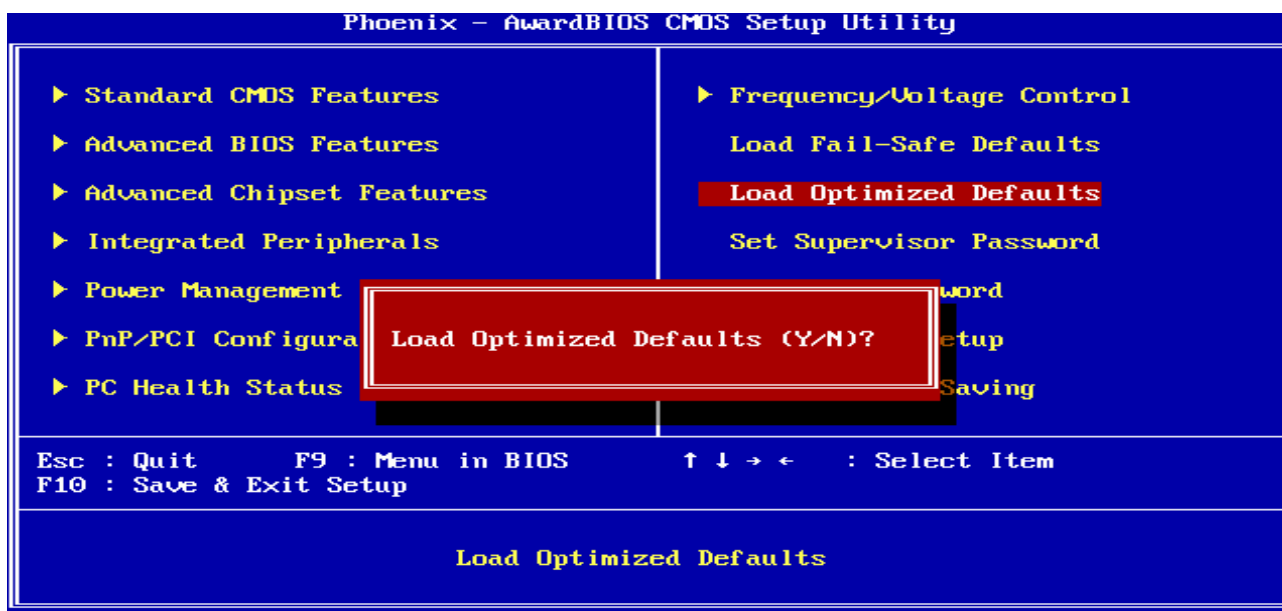

3.5.11 Set Supervisor / User Password

You can set either supervisor or user password, or both of them.

Supervisor Password: able to enter/change the options of setup menus.

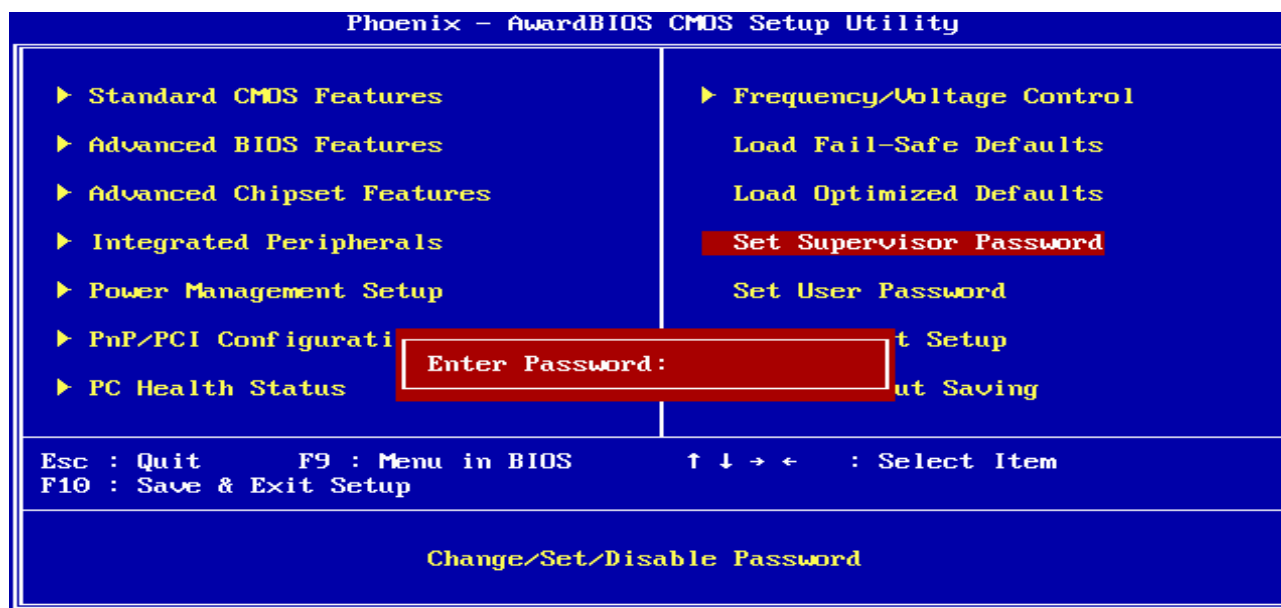

User Password: able to enter but no right to change the options of setup menus.

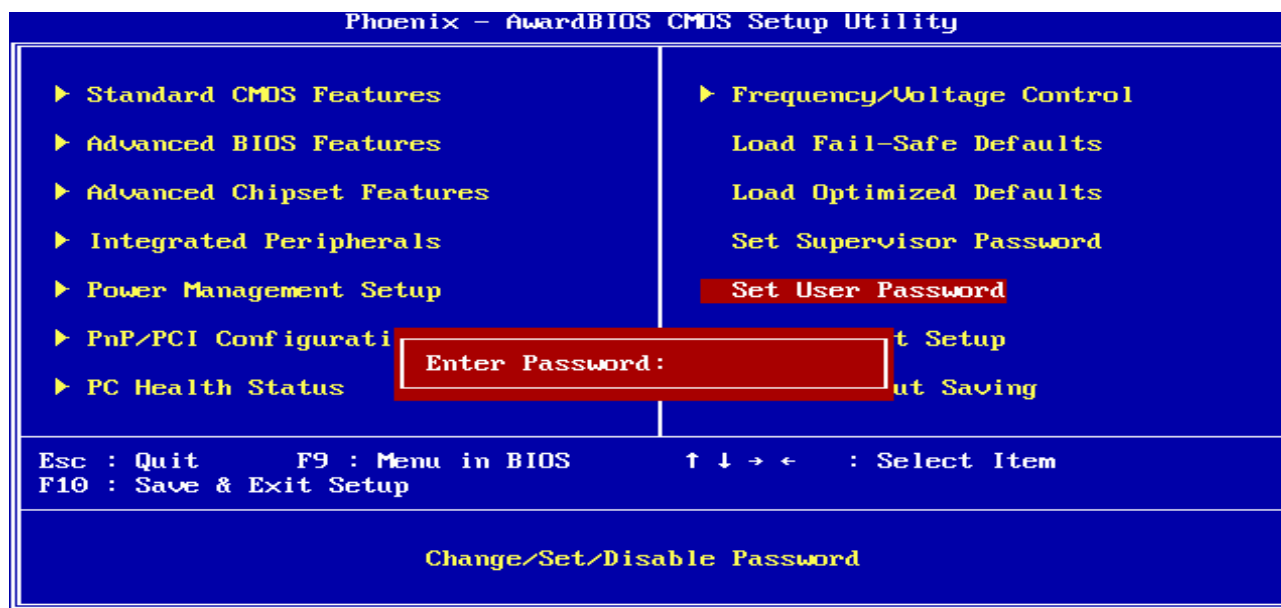

Type the password, up to eight characters in length, and press <Enter>. The password typed now will clear any previously entered password from CMOS memory. You will be asked to confirm the password. Type the password again and press <Enter>. You may also press <Esc> to abort the selection and not enter a password. To disable a password, just press <Enter> when you are prompted to enter the password. A message will confirm the password will be disabled. Once the password is disabled, the system will boot and you can enter Setup freely.

PASSWORD DISABLED.

When a password has been enabled, you will be prompted to enter it every time you try to enter Setup. This prevents an unauthorized person from changing any part of your system configuration. Additionally, when a password is enabled, you can also require the BIOS to request a password every time your system is rebooted. This would prevent unauthorized use of your computer. You determine when the password is required within the BIOS Features Setup Menu and its Security option (see Section 3). If the Security option is set to “System”, the password will be required both at boot and at entry to Setup. If set to “Setup”, prompting only occurs when trying to enter Setup

3.5.12 Save & Exit Setup

Save CMOS value changes to CMOS and exit setup.

Enter <Y> to store the selection made in the menus in CMOS, a special section in memory that stays on after turning the system off. The BIOS configures the system according to the Setup selection stored in CMOS when boot the computer next time.

The system is restarted after saving the values.

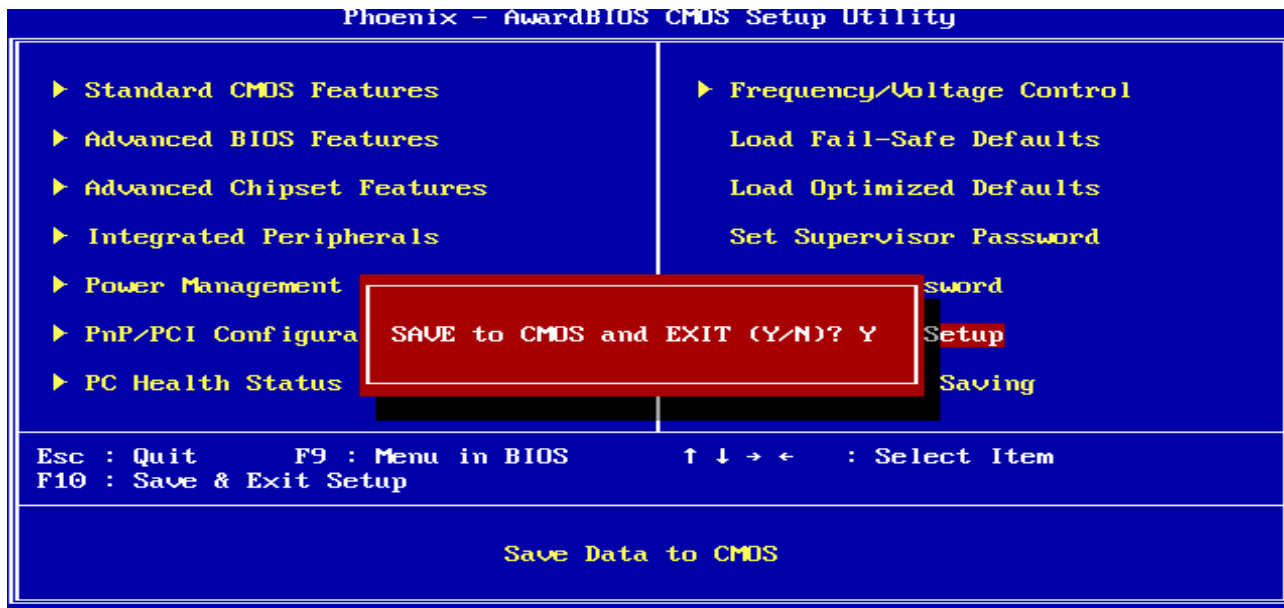

3.5.13 Exit Without Save

Abandon all CMOS value changes and exit setup, and the system is restarted after exiting.

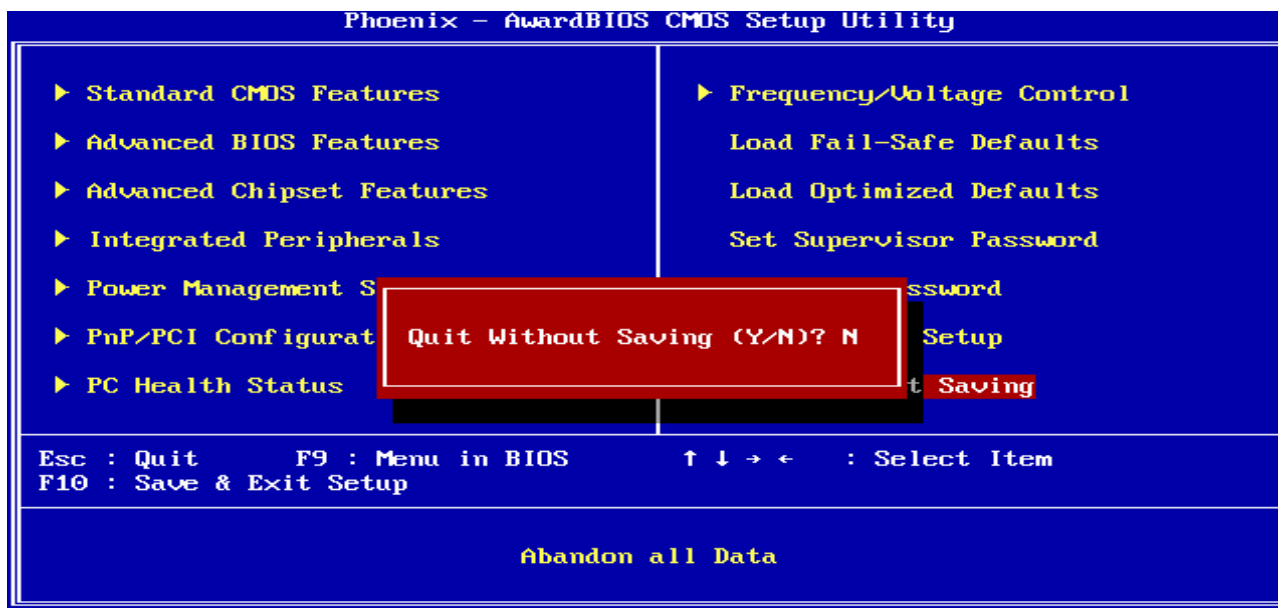

4 Drivers Installation



Note: Installation procedures and screen shots in this section are for your reference and may not be exactly the same as shown on your screen.

4.1 Install Driver

Step 1

Insert the Supporting CD-ROM to CD-ROM drive, and it should show the index page of Advantech's products automatically.

Step 2. Click AIMB-250



Step 3. Click on the driver you want to install



5 Mechanical Drawing



Appendix A: AWARD BIOS POST Messages



Overview

During the Power On Self-Test (POST), if the BIOS detects an error requiring you to do something to fix, it will either sound a beep code or display a message.

If a message is displayed, it will be accompanied by:

PRESS F1 TO CONTINUE, CTRL-ALT-ESC OR DEL TO ENTER SETUP

Post Beep

Currently there are two kinds of beep codes in BIOS. This code indicates that a video error has occurred and the BIOS cannot initialize the video screen to display any additional information. This beep code consists of a single long beep followed by two short beeps. The other code indicates that your DRAM error has occurred. This beep code consists of a single long beep repeatedly.

Error Messages

One or more of the following messages may be displayed if the BIOS detects an error during the POST. This list includes messages for both the ISA and the EISA BIOS.

1. CMOS BATTERY HAS FAILED

CMOS battery is no longer functional. It should be replaced.

2. CMOS CHECKSUM ERROR

Checksum of CMOS is incorrect. This can indicate that CMOS has become corrupt. This error may have been caused by a weak battery. Check the battery and replace if necessary.

3. DISK BOOT FAILURE, INSERT SYSTEM DISK AND PRESS ENTER

No boot device was found. This could mean that either a boot drive was not detected or the drive does not contain proper system boot files. Insert a system disk into Drive A: and press <Enter>. If you assumed the system would boot from the hard drive, make sure the controller is inserted correctly and all cables are properly attached. Also be sure the disk is formatted as a boot device. Then reboot the system.

4. DISKETTE DRIVES OR TYPES MISMATCH ERROR - RUN SETUP

Type of diskette drive installed in the system is different from the CMOS definition. Run Setup to reconfigure the drive type correctly.

5. DISPLAY SWITCH IS SET INCORRECTLY

Display switch on the motherboard can be set to either monochrome or color. This indicates the switch is set to a different setting than indicated in Setup. Determine which setting is correct, and then either turn off the system and change the jumper, or enter Setup and change the VIDEO selection.

6. DISPLAY TYPE HAS CHANGED SINCE LAST BOOT

Since last powering off the system, the display adapter has been changed. You must configure the system for the new display type.

7. EISA Configuration Checksum Error

PLEASE RUN EISA CONFIGURATION UTILITY

The EISA non-volatile RAM checksum is incorrect or cannot correctly read the EISA slot. This can indicate either the EISA non-volatile memory has become corrupt or the slot has been configured incorrectly. Also be sure the card is installed firmly in the slot.

8. EISA Configuration Is Not Complete

PLEASE RUN EISA CONFIGURATION UTILITY

The slot configuration information stored in the EISA non-volatile memory is incomplete.



Note: When either of these errors appears, the system will boot in ISA mode, which allows you to run the EISA Configuration Utility.

9. ERROR ENCOUNTERED INITIALIZING HARD DRIVE

Hard drive cannot be initialized. Be sure the adapter is installed correctly and all cables are correctly and firmly attached. Also be sure the correct hard drive type is selected in Setup.

10. ERROR INITIALIZING HARD DISK CONTROLLER

Cannot initialize controller. Make sure the cord is correctly and firmly installed in the bus. Be sure the correct hard drive type is selected in Setup. Also check to see if any jumper needs to be set correctly on the hard drive.

11. FLOPPY DISK CNTRLR ERROR OR NO CNTRLR PRESENT

Cannot find or initialize the floppy drive controller. Make sure the controller is installed correctly and firmly. If there are no floppy drives installed, be sure the Diskette Drive selection in Setup is set to NONE.

12. Invalid EISA Configuration

PLEASE RUN EISA CONFIGURATION UTILITY

The non-volatile memory containing EISA configuration information was programmed incorrectly or has become corrupt. Re-run EISA configuration utility to correctly program the memory.



Note: When either of these errors appears, the system will boot in ISA mode, which allows you to run the EISA Configuration Utility.

13. KEYBOARD ERROR OR NO KEYBOARD PRESENT

Cannot initialize the keyboard. Make sure the keyboard is attached correctly and no keys are being pressed during the boot.

If you are purposely configuring the system without a keyboard, set the error halt condition in Setup to HALT ON ALL, BUT KEYBOARD. This will cause the BIOS to ignore the missing keyboard and continue the boot.

14. Memory Address Error at ...

Indicates a memory address error at a specific location. You can use this location along with the memory map for your system to find and replace the bad memory chips.

15. Memory parity Error at ...

Indicates a memory parity error at a specific location. You can use this location along with the memory map for your system to find and replace the bad memory chips.

16. MEMORY SIZE HAS CHANGED SINCE LAST BOOT

Memory has been added or removed since the last boot. In EISA mode use Configuration Utility to reconfigure the memory configuration. In ISA mode enter Setup and enter the new memory size in the memory fields.

17. Memory Verify Error at ...

Indicates an error verifying a value already written to memory. Use the location along with your system's memory map to locate the bad chip.

18. OFFENDING ADDRESS NOT FOUND

This message is used in conjunction with the I/O CHANNEL CHECK and RAM PARITY ERROR messages when the segment that has caused the problem cannot be isolated.

19. OFFENDING SEGMENT:

This message is used in conjunction with the I/O CHANNEL CHECK and RAM PARITY ERROR messages when the segment that has caused the problem has been isolated.

AIMB-250 Series

20. PRESS A KEY TO REBOOT

This will be displayed at the bottom screen when an error occurs that requires you to reboot. Press any key and the system will reboot.

21. PRESS F1 TO DISABLE NMI, F2 TO REBOOT

When BIOS detects a Non-maskable Interrupt condition during boot, this will allow you to disable the NMI and continue to boot, or you can reboot the system with the NMI enabled.

22. RAM PARITY ERROR - CHECKING FOR SEGMENT ...

Indicates a parity error in Random Access Memory.

23. Should Be Empty But EISA Board Found

PLEASE RUN EISA CONFIGURATION UTILITY

A valid board ID was found in a slot that was configured as having no board ID.



Note: When either of these errors appears, the system will boot in ISA mode, which allows you to run the EISA Configuration Utility.

24. Should Have EISA Board But Not Found

PLEASE RUN EISA CONFIGURATION UTILITY

The board installed is not responding to the ID request, or no board ID has been found in the indicated slot.



Note: When either of these errors appears, the system will boot in ISA mode, which allows you to run the EISA Configuration Utility.

25. Slot Not Empty

Indicates that a slot designated as empty by the EISA Configuration Utility actually contains a board.



Note: When either of these errors appears, the system will boot in ISA mode, which allows you to run the EISA Configuration Utility.

26. SYSTEM HALTED, (CTRL-ALT-DEL) TO REBOOT ...

Indicates the present boot attempt has been aborted and the system must be rebooted. Press and hold down the CTRL and ALT keys and press DEL.

27. Wrong Board In Slot**PLEASE RUN EISA CONFIGURATION UTILITY**

The board ID does not match the ID stored in the EISA non-volatile memory.



Note: When either of these errors appears, the system will boot in ISA mode, which allows you to run the EISA Configuration Utility.

28. FLOPPY DISK(S) fail (80) → Unable to reset floppy subsystem.

29. FLOPPY DISK(S) fail (40) → Floppy Type mismatch.

30. Hard Disk(s) fail (80) → HDD reset failed.

31. Hard Disk(s) fail (40) → HDD controller diagnostics failed.

32. Hard Disk(s) fail (20) → HDD initialization error.

33. Hard Disk(s) fail (10) → Unable to recalibrate fixed disk.

34. Hard Disk(s) fail (08) → Sector Verify failed.

35. Keyboard is locked out - Unlock the key.

BIOS detect the keyboard is locked. P17 of keyboard controller is pulled low.

36. Keyboard error or no keyboard present.

Cannot initialize the keyboard. Make sure the keyboard is attached correctly and no keys are being pressed during the boot.

37. Manufacturing POST loop.

System will repeat POST procedure infinitely while the P15 of keyboard controller is pull low. This is also used for M/B burn in test.

38. BIOS ROM checksum error - System halted.

The checksum of ROM address F0000H-FFFFFFH is bad.

39. Memory test fail.

BIOS reports the memory test fail if the onboard memory is tested error.

AIMB-250 Series

40. POST Codes

Please take reference to Phoenix-Award website for the latest post codes.

<http://www.phoenix.com/en/Customer+Services/BIOS/AwardBIOS/Award+Error+Codes.htm>

40.1 Normal POST Code



Note: EISA POST codes are typically output to port address 300h. ISA POST codes are output to port address 80h.

Code (hex)	Name	Description
C0	Turn Off Chipset and CPU test	OEM Specific-Cache control cache Processor Status (1FLAGS) Verification. Tests the following processor status flags: Carry, zero, sign, overflow, the BIOS sets each flag, verifies They are set, then turns each flag off and verifies it is off. Read/Write/Verify all CPU registers except SS, SP, and BP with data pattern FF and 00. RAM must be periodically refreshed to keep the memory from decaying. This function ensures that the memory refresh function is working properly.
C1	Memory Presence	First block memory detect OEM Specific-Test to size on-board memory. Early chip set initialization Memory presence test OEM chip set routines clear low 64K of memory Test first 64K memory.
C2	Early Memory Initialization	OEM Specific- Board Initialization
C3	Extend Memory DRAM select	OEM Specific- Turn on extended memory Initialization Cyrix CPU initialization, Cache initialization
C4	Special Display Handling	OEM Specific- Display/Video Switch handling so that switch handling display switch errors never occurs
C5	Early Shadow	OEM specific- Early shadow enable for fast boot
C6	Cache presence test	External cache size detection
CF	CMOS Check	CMOS checkup
B0	Spurious	If interrupt occurs in protected mode.
B1	Unclaimed NMI	If unmasked NMI occurs, display Press F1 to disable NMI, F2 reboot.
BF	Program Chip Set	To program chipset from defaults values
E1-EF	Setup Pages	E1- Page 1, E2 - Page 2, etc.
1	Force load Default to chipset	Chipset defaults program
2	Reserved	

Code (hex)	Name	Description
3	Early Superio Init	Early Initialized the super IO
4	Reserved	
5	Blank video	Reset Video controller
6	Reserved	
7	Init KBC	Keyboard controller init
8	KB test	Test the Keyboard
9	Reserved	
A	Mouse Init	Initialized the mouse
B	Onboard Audio init	Onboard audio controller initialize if exist
C	Reserved	
D	Reserved	
E	CheckSum Check	Check the intergraty of the ROM, BIOS and message
F	Reserved	
10	Auto detec EEPROM	Check Flash type and copy flash write/erase routines to 0F000h segments
11	Reserved	
12	Cmos Check	Check Cmos Circuitry and reset CMOS
13	Reserved	
14	Chipset Default load	Program the chipset registers with CMOS values
15	Reserved	
16	Clock Init	Init onboard clock generator
17	Reserved	
18	Identify the CPU	Check the CPU ID and init L1/L2 cache
19	Reserved	
1A	Reserved	
1B	Setup Interrupt Vector Table	Initialize first 120 interrupt vectors with SPURIOUS_INT_HDLR and initialize INT 00h-1Fh according to INT_TBL
1C	Reserved	
1D	Early PM Init	First step initialize if single CPU onboard
1E	Reserved	
1F	Re-initial KB	Re-init KB
20	Reserved	
21	HPM init	If support HPM, HPM get initialized here
22	Reserved	
23	Test CMOS Interface and battery Status	Verifies CMOS is working correctly, detects bad battery. If failed, load CMOS defaults and load into chipset
24	Reserved	

AIMB-250 Series

Code (hex)	Name	Description
25	Reserved	
26	Reserved	
27	KBC final Init	Final Initial KBC and setup BIOS data area
28	Reserved	
29	Initialize Video Interface	Read CMOS location 14h to find out type of video in use. Detect and Initialize Video Adapter.
2A	Reserved	
2B	Reserved	
2C	Reserved	
2D	Video memory test	Test video memory, write sign-on message to screen. Setup shadow RAM - Enable shadow according to Setup.
2E	Reserved	
2F	Reserved	
30	Reserved	
31	Reserved	
32	Reserved	
33	PS2 Mouse setup	Setup PS2 Mouse and reset KB
34	Reserved	
35	Test DMA Controller 0	Test DMA Controller 0
36	Reserved	
37	Test DMA Controller 1	Test DMA Controller 1
38	Reserved	
39	Test DMA Page Registers	Test DMA Page Registers.
3A	Reserved	
3B	Reserved	
3C	Test Timer Counter 2	Test 8254 Timer 0 Counter 2.
3D	Reserved	
3E	Test 8259-1 Mask Bits	Verify 8259 Channel 1 masked interrupts by alternately turning off and on the interrupt lines.
3F	Reserved	
40	Test 8259-2 Mask Bits	Verify 8259 Channel 2 masked interrupts by alternately turning off and on the interrupt lines.
41	Reserved	
42	Reserved	

Code (hex)	Name	Description
43	Test Stuck 8259's Interrupt Bits Test 8259 Interrupt Functionality	Turn off interrupts then verify no interrupt mask register is on. Force an interrupt and verify the interrupt occurred.
44	Reserved	
45	Reserved	
46	Reserved	
47	Set EISA Mode	If EISA non-volatile memory checksum is good, execute EISA initialization. If not, execute ISA tests and clear EISA mode flag.
48	Reserved	
49	Size Base and Extended Memory	Size base memory from 256K to 640K and extended memory above 1MB.
4A	Reserved	
4B	Reserved	
4C	Reserved	
4D	Reserved	
4E	Test Base and Extended Memory	Test base memory from 256K to 640K and extended memory above 1MB using various patterns. NOTE: This test is skipped in EISA mode and can be skipped with ESC key in ISA mode.
4F	Reserved	
50	USB init	Initialize USB controller
51	Reserved	
52	Memory Test	Test all memory of memory above 1MB using Virtual 8086 mode, page mode and clear the memory
53	Reserved	
54	Reserved	
55	CPU display	Detect CPU speed and display CPU vendor specific version string and turn on all necessary CPU features
56	Reserved	
57	PnP Init	Display PnP logo and PnP early init
58	Reserved	
59	Setup Virus Protect	Setup virus protect according to Setup
5A	Reserved	
5B	Awdflash Load	If required, will auto load Awdflash.exe in POST
5C	Reserved	
5D	Onboard I/O Init	Initializing onboard superIO

AIMB-250 Series

Code (hex)	Name	Description
5E	Reserved	
5F	Reserved	
60	Setup enable	Display setup message and enable setup functions
61	Reserved	
62	Reserved	
63	Initialize & Install Mouse	Detect if mouse is present, initialize mouse, install interrupt vectors.
64	Reserved	
65	PS2 Mouse special	Special treatment to PS2 Mouse port
66	Reserved	
67	ACPI init	ACPI sub-system initializing
68	Reserved	
69	Setup Cache Controller	Initialize cache controller.
6A	Reserved	
6B	Setup Entering	Enter setup check and auto- configuration check up
6C	Reserved	
6D	Initialize Floppy Drive & Controller	Initialize floppy disk drive controller and any drives.
6E	Reserved	
6F	FDD install	Install FDD and setup BIOS data area parameters
70	Reserved	
71	Reserved	
72	Reserved	
73	Initialize Hard Drive & Controller	Initialize hard drive controller and any drives.
74	Reserved	
75	Install HDD	IDE device detection and install
76	Reserved	
77	Detect & Initialize Serial/Parallel Port	Initialize any serial and parallel ports (also game port).
78	Reserved	
79	Reserved	
7A	Detect & Initialize Math Coprocessor	Initialize math coprocessor.
7B	Reserved	
7C	HDD Check for Write protection	HDD check out

Code (hex)	Name	Description
7D	Reserved	
7E	Reserved	
7F	POST error check	Check POST error and display them and ask for user intervention
80	Reserved	
81	Reserved	
82	Security Check	Ask password security (optional).
83	Write CMOS	Write all CMOS values back to RAM and clear screen.
84	Pre-boot Enable	Enable parity checker. Enable NMI, Enable cache before boot.
85	Initialize Option ROMs	Initialize any option ROMs present from C8000h to EFFFFh. NOTE: When FSCAN option is enabled, ROMs initialize from C8000h to F7FFFh.
86	Reserved	
87	Reserved	
88	Reserved	
89	Reserved	
8A	Reserved	
8B	Reserved	
8C	Reserved	
8D	Reserved	
8E	Reserved	
8F	Reserved	
90	Reserved	
91	Reserved	
92	Reserved	
93	Boot Medium detection	Read and store boot partition head and cylinders values in RAM
94	Final Init	Final init for last micro details before boot
95	Special KBC patch	Set system speed for boot. Setup NumLock status according to Setup
96	Boot Attempt	Set low stack Boot via INT 19h.
FF	Boot	

AIMB-250 Series

40.2 Quick POST Codes

Code (hex)	Name	Description
65	Init onboard device	Early Initialized the super IO. Reset Video controller. Keyboard controller init Test the Keyboard Initialized the mouse Onboard audio controller initialize if exist. Check the intergraty of the ROM, BIOS and message Check Flash type and copy flash write/erase routines to 0F000h segments Check Cmos Circuitry and reset CMOS Program the chipset registers with CMOS values Init onboard clock generator
66	Early Sytem setup	Check the CPU ID and init L1/L2 cache. Initialize first 120 interrupt vectors with SPURIOUS_INT_HDLR and 10 initialize INT 00h-1Fh according to INT_TBL First step initialize if single CPU onboard. Re-init KB If support HPM, HPM get initialized here.
67	KBC and CMOS Init	Verifies CMOS is working correctly, detects bad battery. If failed, load CMOS defaults and load into chipset. Final Initial KBC and setup BIOS data area.
68	Video Init	Read CMOS location 14h to find out type of video in use. Detect and Initialize Video Adapter. Test video memory, write sign-on message to screen. Setup shadow RAM - Enable shadow according to Setup.
69	8259 Init	Init 8259 channel 1 and mask IRQ 9
6A	Memory test	Quick Memory Test
6B	CPU Detect and IO init	CPU vendor specific version string and turn on all necessary CPU features Display PnP logo and PnP early init Setup virus protect according to Setup. If required, will auto load Awdflash.exe in POST Initializing onboard superIO
6C	Reserved	
6D	Reserved	
6E	Reserved	
6F	Reserved	
70	Setup Init	Display setup message and enable setup functions Detect if mouse is present, initialize mouse, install interrupt vectors. Special treatment to PS2 Mouse port ACPI sub-system initializing
71	Setup Cache Controller	Initialize cache controller.

Code (hex)	Name	Description
72	Install FDD	Enter setup check and auto11 configuration check up Initialize floppy disk drive controller and any drives. Install FDD and setup BIOS data area parameters
73	Install FDD	Initialize hard drive controller and any drives. IDE device detection and install Initialize any serial and parallel ports (also game port).
74	Detect & Initialize Math Coprocessor	Initialize math coprocessor.
75	HDD Check for Write protection	HDD check out
76	Reserved	
77	Display POST error	Check POST error and display them and ask for user intervention Ask password security (optional).
78	CMOS and Option ROM Init	Write all CMOS values back to RAM and clear screen. Enable parity checker Enable NMI, Enable cache before boot. Initialize any option ROMs present from C8000h to EFFFFh. NOTE: When FSCAN option is enabled, ROMs initialize from C8000h to F7FFFh.
79	Reserved	
7A	Reserved	
7B	Reserved	
7C	Reserved	
7D	Boot Medium detection	Read and store boot partition head and cylinders values in RAM
7E	Final Init	Final init for last micro details before boot
7F	Special KBC patch	Set system speed for boot. Setup NumLock status according to Setup.
80	Boot Attempt	Set low stack Boot via INT 19h.
FF	Boot	

AIMB-250 Series

40.3S4 POST Codes

Code (hex)	Name	Description
5A	Early Chipset Init	Early Initialized the super IO. Reset Video controller. Keyboard controller init. Test the Keyboard Iniltized the mouse
5B	Cmos Check	Check Cmos Circuitry and reset CMOS
5C	Chipset default Prog	Program the chipset registers with CMOS values. Init onboard clock generator
5D	Identify the CPU	Check the CPU ID and init L1/L2 cache Initialize first 120 interrupt vectors with SPURIOUS_INT_HDLR and INT 00h-1Fh according to INT_TBL. First step initialize if single CPU Onboard. Re-init KB If support HPM, HPM get initialized Here.
5E	Setup Interrupt Vector Table	Initialize first 120 interrupt vectors with SPURIOUS_INT_HDLR and INT 00h-1Fh according to INT_TBL. First step initialize if single CPU Onboard. Re-init KB If support HPM, HPM get initialized here.
5F	Test CMOS Interface and Battery status	Verifies CMOS is working correctly, detects bad battery. If failed, load CMOS defaults and load into chipset.
60	KBC final Init	Final Initial KBC and setup BIOS data area
61	Initialize Video Interface	Read CMOS location 14h to find out type of video in use. Detect and Initialize Video Adapter.
62	Video memory test	Test video memory, write sign-on Test video memory, write sign-on message to screen. Setup shadow RAM - Enable shadow according to Setup.
63	Setup PS2 mouse and test DMA	Setup PS2 Mouse and reset KB Test DMA channel 0
64	Test 8259	Test 8259 channel 1 and mask IRQ 9
65	Init Boot Device	Detect if mouse is present, initialize mouse, install interrupt vectors. Special treatment to PS2 Mouse port ACPI sub-system initializing Initialize cache controller.
66	Install Boot Devices	Enter setup check and auto-configuration check up Initialize floppy disk drive controller and any drives. Install FDD and setup BIOS data area Parameters Initialize hard drive controller and any drives. IDE device detection and install
67	Cache Init	Cache init and USB init
68	PM init	PM initialization
69	PM final Init and issue SMI	Final init Before resume
FF	Full on	

40.4 BootBlock POST Codes

Code (hex)	Name	Description
1	Base memory test	Clear base memory area (0000:0000--9000:ffffh)
5	KB init	Initialized KBC
12	Install interrupt vectors	Install int. vector (0-77), and initialized 00-1fh to their proper place
0D	Init Video	Video initializing
41	Init FDD	Scan floppy and media capacity for onboard superIO
FF	Boot	Load boot sector